

Dimensions: [mm]

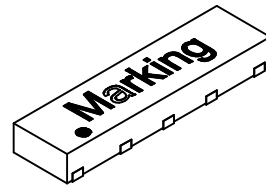
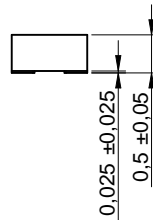
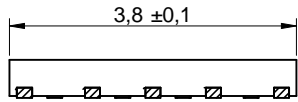
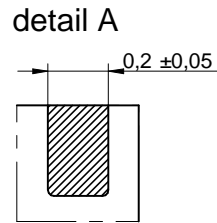
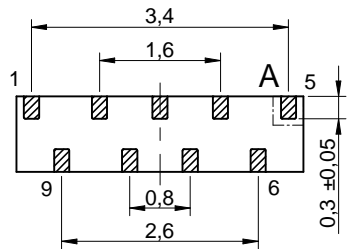

Scale - 10:1

Product Marking:

Pin 1	•
Marking	W1481

Recommended Land Pattern: [mm]

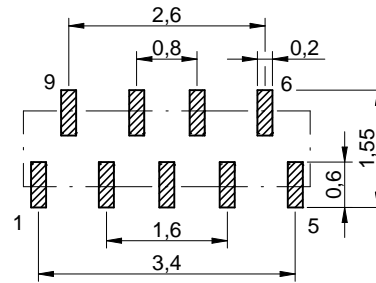

Scale - 10:1

Schematic:

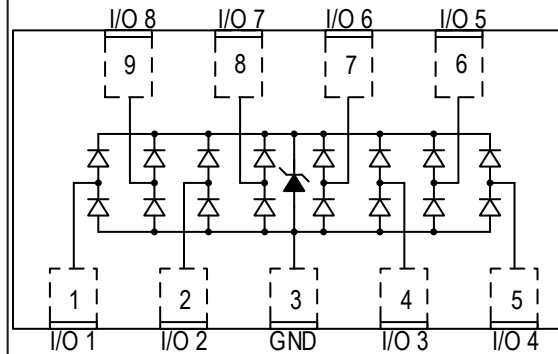

Absolute Maximum Ratings (Ambient Temperature 25°C):

Properties	Test conditions		Value	Unit
(Reverse) Peak Pulse Current	$t_p = 8/20\mu s$	I_{Peak}	4	A
ESD Air Discharge Capability ¹⁾		$V_{ESD Air}$	15	kV
ESD Contact Discharge Capability ²⁾		$V_{ESD Contact}$	10	kV
Channels	8			

¹⁾ in positive and negative polarity
²⁾ in positive and negative polarity

General Information:

It is recommended that the temperature of the component does not exceed +85°C under worst case conditions

Storage Temperature (in original packaging)	-20 °C up to +60 °C
Operating Temperature	-55 °C up to +85 °C
Test conditions of Electrical Properties: +20°C, 33% RH if not specified differently	
$V_{Ch Clamp ESD}$ was measured by Transmission Line Pulsing (TLP) System. TLP conditions: $Z_0=50\Omega$, $t_p=100ns$, $t_r=1ns$	
Compliant: IEC 61000-4-2 and -5	

Würth Elektronik eiSos GmbH & Co. KG
 EMC & Inductive Solutions

Max-Eyth-Str. 1
 74638 Waldenburg
 Germany
 Tel. +49 (0) 79 42 945 - 0

www.we-online.com
 eiSos@we-online.com



CREATED KaS	CHECKED RoD	GENERAL TOLERANCE DIN ISO 2768-1m	PROJECTION METHOD
DESCRIPTION WE-TV S TV S Diode – Super Speed Series		ORDER CODE 824014881	
SIZE DFN3810-9L	REVISION 001.000	STATUS Valid	DATE (YYYY-MM-DD) 2017-07-13
BUSINESS UNIT eiSos		PAGE 1/8	

Electrical Properties:

Properties	Test conditions		Value			Unit
			min.	typ.	max.	
Channel Operating Voltage	I/O to GND	V_{Ch}			1.2	V
(Reverse) Breakdown Voltage	$I_{BR}=1\text{mA}$; I/O to GND	V_{BR}	4.5			V
Channel (Reverse) Leakage Current	$V_{I/O}=V_{DC}$; $V_{GND}=0V$	$I_{Ch Leak}$			0.5	μA
Forward Voltage	$I_F=15\text{mA}$; GND to I/O	V_F	0.6	0.9	1.2	V
(Channel) Input Capacitance	$V_{GND}=0V$ $V_{I/O}=1V$, $f=1\text{MHz}$, I/O to GND	C_{Ch}		0.35	0.5	pF
Channel to Channel Input Capacitance	$V_{GND}=0V$ $V_{I/O}=1V$, $f=1\text{MHz}$, between I/O pins	C_{Cross}		0.03	0.08	pF
Channel ESD Clamping Voltage	IEC 61000-4-2 +8kV (TLP=16A) Contact Mode, I/O to GND	$V_{Ch Clamp ESD}$		7		V

Insertion Loss SDD21 (I/O to GND):

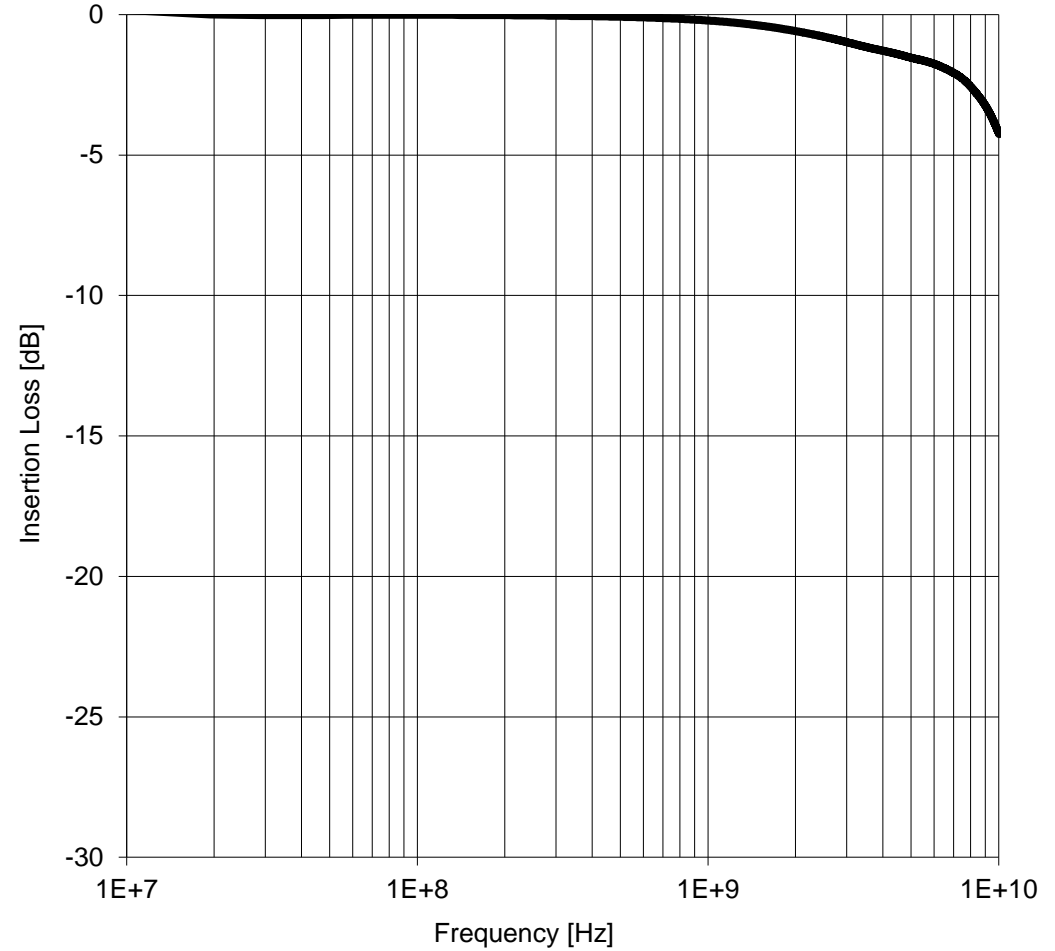

Würth Elektronik eiSos GmbH & Co. KG EMC & Inductive Solutions Max-Eyth-Str. 1 74638 Waldenburg Germany Tel. +49 (0) 79 42 945 - 0 www.we-online.com eiSos@we-online.com		CREATED KaS	CHECKED RoD	GENERAL TOLERANCE DIN ISO 2768-1m	PROJECTION METHOD
DESCRIPTION WE-TVS TVS Diode – Super Speed Series			ORDER CODE 824014881		
SIZE DFN3810-9L	REVISION 001.000	STATUS Valid	DATE (YYYY-MM-DD) 2017-07-13	BUSINESS UNIT eiSos	PAGE 2/8

Transmission Line Pulsing (TLP) Measurement:

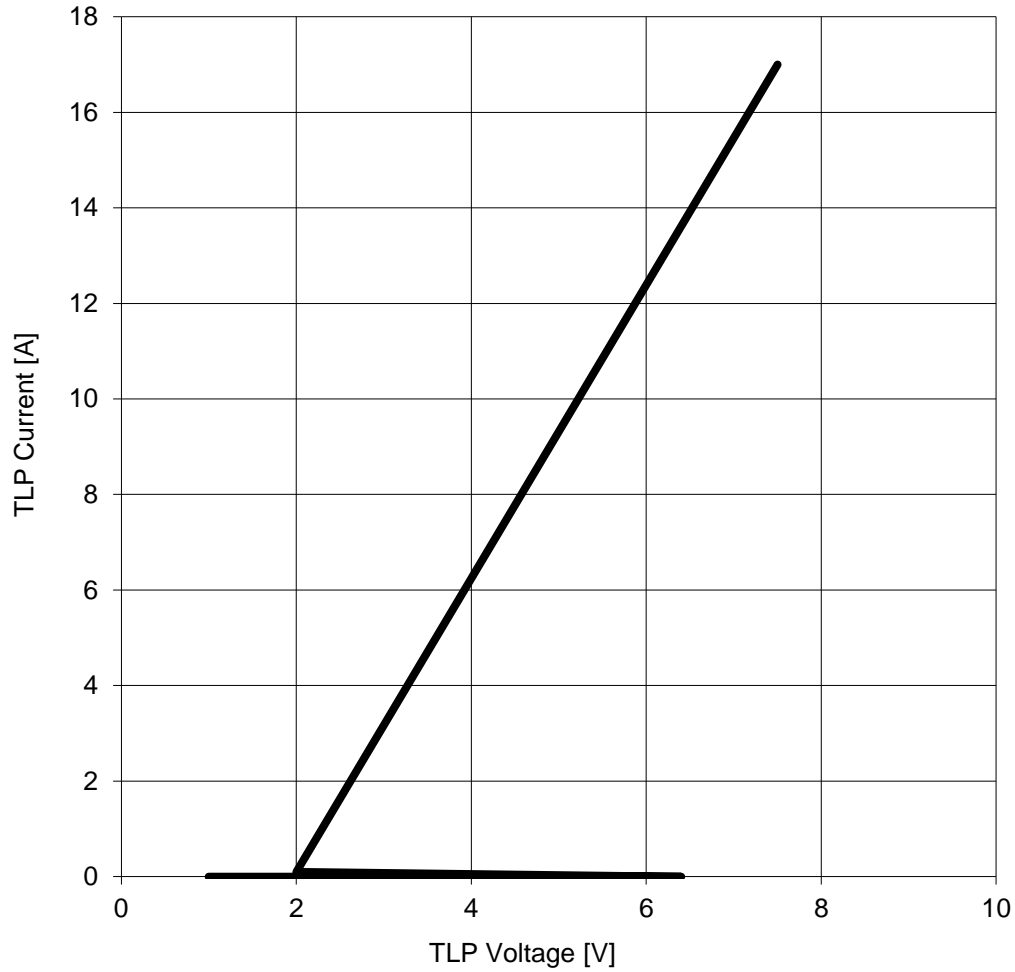

Variation of C10 vs. V10:

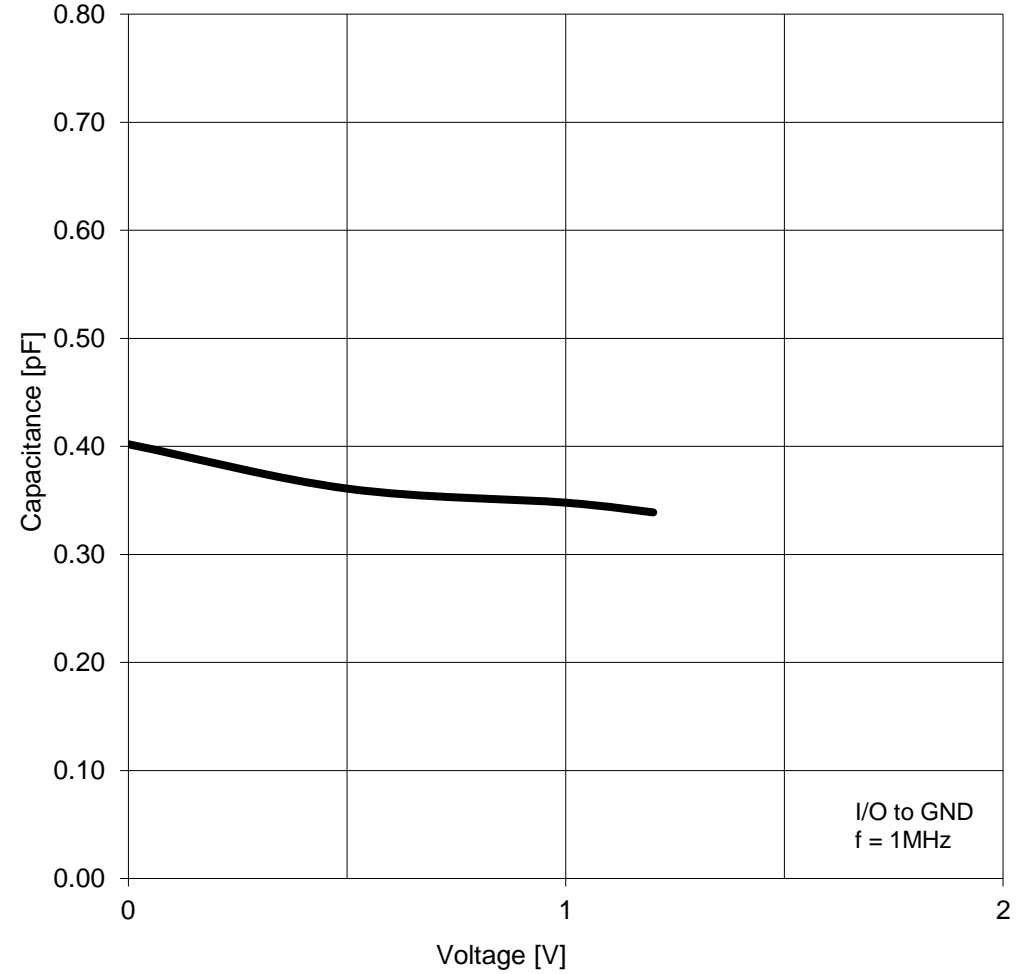

Würth Elektronik eiSos GmbH & Co. KG
EMC & Inductive Solutions

Max-Eyth-Str. 1
74638 Waldenburg
Germany
Tel. +49 (0) 79 42 945 - 0

www.we-online.com
eiSos@we-online.com



CREATED KaS	CHECKED RoD	GENERAL TOLERANCE DIN ISO 2768-1m	PROJECTION METHOD
DESCRIPTION WE-TVS TVS Diode – Super Speed Series			ORDER CODE 824014881
SIZE DFN3810-9L	REVISION 001.000	STATUS Valid	DATE (YYYY-MM-DD) 2017-07-13
BUSINESS UNIT eiSos		PAGE 3/8	

Variation of CX vs. VIO:

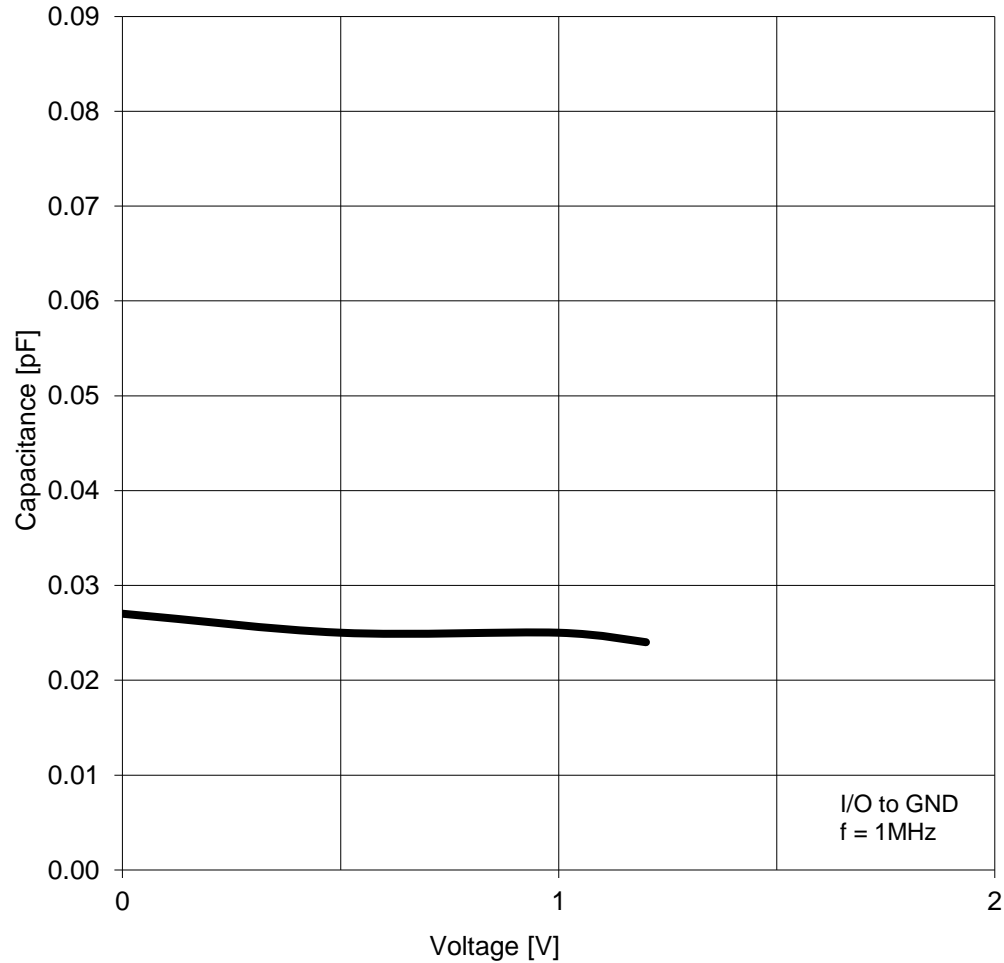

Würth Elektronik eiSos GmbH & Co. KG EMC & Inductive Solutions Max-Eyth-Str. 1 74638 Waldenburg Germany Tel. +49 (0) 79 42 945 - 0 www.we-online.com eiSos@we-online.com	CREATED KaS	CHECKED RoD	GENERAL TOLERANCE DIN ISO 2768-1m	PROJECTION METHOD
	DESCRIPTION WE-TVS TVS Diode – Super Speed Series			ORDER CODE 824014881
	SIZE DFN3810-9L	REVISION 001.000	STATUS Valid	DATE (YYYY-MM-DD) 2017-07-13

Packaging Specification - Tape and Reel: [mm]

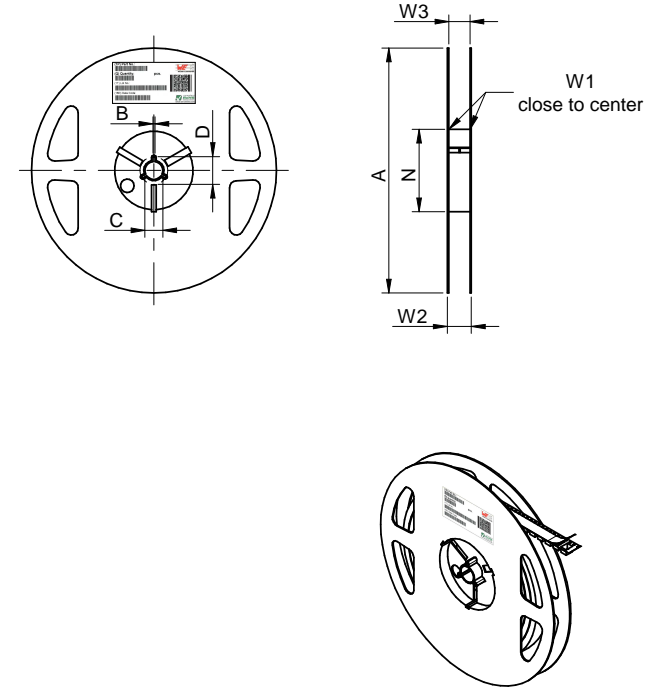
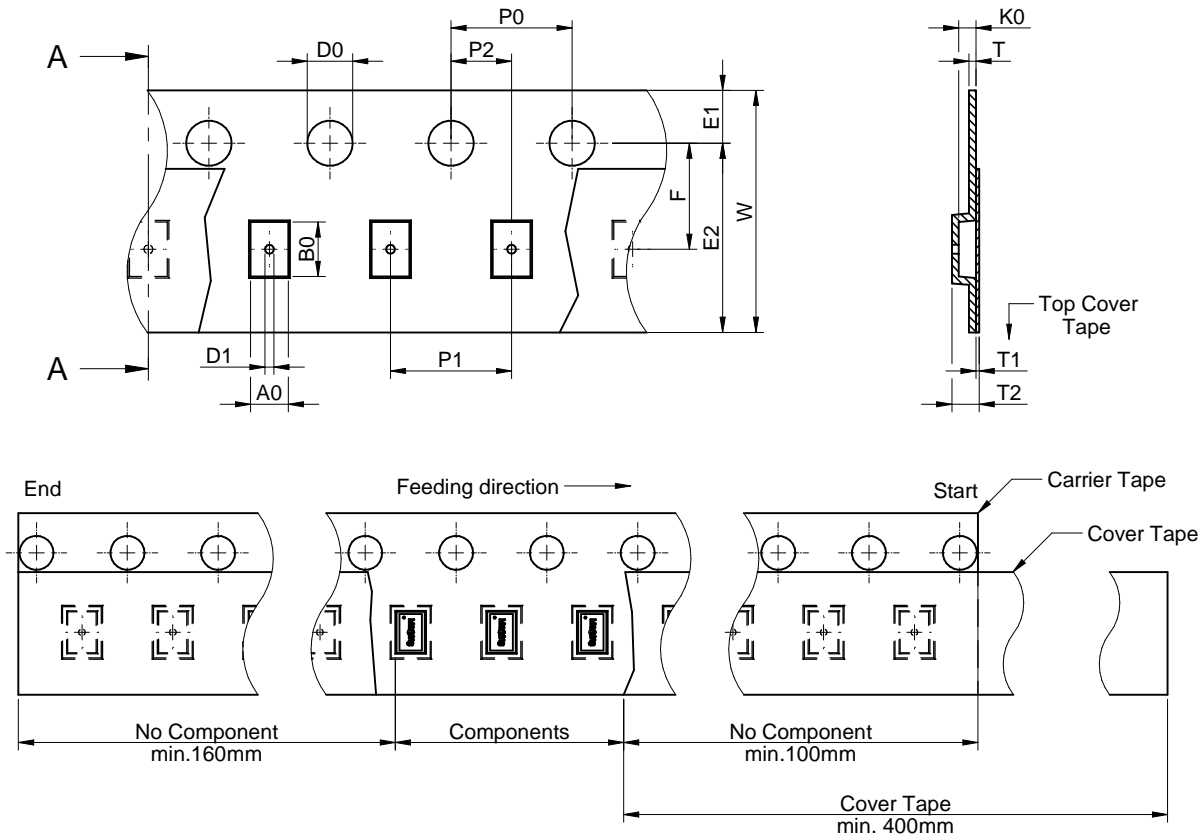

packaging is referred to the international standard IEC 60286-3:2013

	A0	B0	W	T	T1	T2	K0	P0	P1	P2	D0	D1	E1	E2	F	Tape Type 2a	VPE / packaging unit	
tolerance	typ.	typ.	+0,3/-0,1	max.	max.	typ.	typ.	±0,1	±0,05	±0,05	+0,1/-0,0	min.	±0,1	min.	±0,05		pcs.	
size	1610	1,2	4,0	12,0	0,25	0,1	1,05	0,7	4,0	4,00	2,0	1,5	0,30	1,75	6,25	5,5	Polystyrene	3000

tolerance		± 2,0	min.	min.	min.	min.	+ 2	max.	min.	max.
Tape width	12 mm	178.00	1.50	12.80	20.20	50.00	12.40	18.40	11.90	15.40

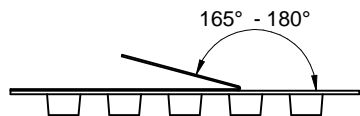

	Pull-of force
Tape width	12 mm
	0,1 N - 1,3 N

Würth Elektronik eiSos GmbH & Co. KG
EMC & Inductive Solutions

Max-Eyth-Str. 1
74638 Waldenburg
Germany
Tel. +49 (0) 79 42 945 - 0

www.we-online.com
eiSos@we-online.com



CREATED	CHECKED	GENERAL TOLERANCE	PROJECTION METHOD
KaS	RoD	DIN ISO 2768-1m	
DESCRIPTION		ORDER CODE	
WE-TVS TVS Diode – Super Speed Series		824014881	
SIZE	REVISION	STATUS	DATE (YYYY-MM-DD)
DFN3810-9L	001.000	Valid	2017-07-13
		BUSINESS UNIT	PAGE
		eiSos	5/8

This electronic component has been designed and developed for usage in general electronic equipment only. This product is not authorized for use in equipment where a higher safety standard and reliability standard is especially required or where a failure of the product is reasonably expected to cause severe personal injury or death, unless the parties have executed an agreement specifically governing such use. Moreover Würth Elektronik eiSos GmbH & Co KG products are neither designed nor intended for use in areas such as military, aerospace, aviation, nuclear control, submarine, transportation (automotive control, train control, ship control), transportation signal, disaster prevention, medical, public information network etc. Würth Elektronik eiSos GmbH & Co KG must be informed about the intent of such usage before the design-in stage. In addition, sufficient reliability evaluation checks for safety must be performed on every electronic component which is used in electrical circuits that require high safety and reliability functions or performance.

Classification Reflow Profile for SMT components:



Classification Reflow Soldering Profile:

Profile Feature		Value
Preheat Temperature Min	$T_{s\ min}$	150 °C
Preheat Temperature Max	$T_{s\ max}$	200 °C
Preheat Time t_s from $T_{s\ min}$ to $T_{s\ max}$	t_s	60 - 120 seconds
Ramp-up Rate (T_L to T_p)		3 °C/ second max.
Liquidous Temperature	T_L	217 °C
Time t_L maintained above T_L	t_L	60 - 150 seconds
Peak package body temperature	T_p	see table below
Time within 5°C of actual peak temperature	t_p	20 - 30 seconds
Ramp-down Rate (T_L to T_p)		6 °C/ second max.
Time 25°C to peak temperature		8 minutes max.

refer to IPC/ JEDEC J-STD-020E

Package Classification Reflow Temperature:

Properties	Volume mm ³ <350	Volume mm ³ 350-2000	Volume mm ³ >2000
PB-Free Assembly Package Thickness < 1.6 mm	260 °C	260 °C	260 °C
PB-Free Assembly Package Thickness 1.6 mm - 2.5 mm	260 °C	250 °C	245 °C
PB-Free Assembly Package Thickness ≥ 2.5 mm	250 °C	245 °C	245 °C

refer to IPC/ JEDEC J-STD-020E

Würth Elektronik eiSos GmbH & Co. KG
EMC & Inductive Solutions

Max-Eyth-Str. 1
74638 Waldenburg
Germany
Tel. +49 (0) 79 42 945 - 0

www.we-online.com
eiSos@we-online.com



CREATED KaS	CHECKED RoD	GENERAL TOLERANCE DIN ISO 2768-1m	PROJECTION METHOD
DESCRIPTION WE-TV5 TV5 Diode – Super Speed Series		ORDER CODE 824014881	
SIZE DFN3810-9L	REVISION 001.000	STATUS Valid	DATE (YYYY-MM-DD) 2017-07-13
BUSINESS UNIT eiSos		PAGE 6/8	

Cautions and Warnings:

The following conditions apply to all goods within the product series of WE-TVS Super Speed of Würth Elektronik eiSos GmbH Co. KG:

General:

All recommendations according to the general technical specifications of the data-sheet have to be complied with. Further, the TVS Diode is not designed for voltage stabilization with continuous power dissipation.

The disposal and operation of the product within ambient conditions which probably alloy or harm the component surface has to be avoided.

The exposure of steam, saline spray, atmosphere with reduced oxygen content, corrosive gases, rain or condensation and direct sunlight shall be prohibited.

If the product is potted in customer applications, the potting material might shrink and react chemically during and after hardening. According to this the product is exposed to the pressure and material of the potting material with the effect that the plastic body and termination is possibly damaged by this pressure or the chemically reaction and so the electrical as well as the mechanical characteristics and the life time are in danger to be affected. After the potting material is cured, the plastic body and termination of the product have to be checked if any reduced electrical or mechanical functions or destructions have occurred.

The responsibility for the applicability of customer specific products and use in a particular customer design is always within the authority of the customer. All technical specifications for standard products do also apply for customer specific products.

Cleaning agents that are used to clean the application might damage or change the characteristics of the component, body, pins or termination and might reduce the life time.

Direct mechanical impact to the product shall be prevented as the ceramic material of the ceramic body could flake or in the worst case it could break.

Signals operated continuously with a high ratio of direct-current voltage might have an influence on the product life time.

Product specific:

Follow all instructions mentioned in the data sheet, especially:

- The solder profile has to be complied with according to the technical reflow soldering specification, otherwise no warranty will be sustained.
- All products shall be used before the end of the period of 12 months based on the product date-code, if not a 100% solderability can't be warranted.

- Violation of the technical product specifications such as exceeding the nominal rated voltage will result in the loss of warranty.

The general and product specific cautions comply with the state of the scientific and technical knowledge and are believed to be accurate and reliable; however, no responsibility is assumed for inaccuracies or incompleteness.

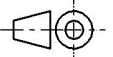
Würth Elektronik eiSos GmbH & Co. KG EMC & Inductive Solutions Max-Eyth-Str. 1 74638 Waldenburg Germany Tel. +49 (0) 79 42 945 - 0 www.we-online.com eiSos@we-online.com		CREATED KaS	CHECKED RoD	GENERAL TOLERANCE DIN ISO 2768-1m	PROJECTION METHOD 
DESCRIPTION WE-TVS TVS Diode – Super Speed Series			ORDER CODE 824014881		
SIZE DFN3810-9L	REVISION 001.000	STATUS Valid	DATE (YYYY-MM-DD) 2017-07-13	BUSINESS UNIT eiSos	PAGE 7/8

Important Notes

The following conditions apply to all goods within the product range of Würth Elektronik eiSos GmbH & Co. KG:

1. General Customer Responsibility

Some goods within the product range of Würth Elektronik eiSos GmbH & Co. KG contain statements regarding general suitability for certain application areas. These statements about suitability are based on our knowledge and experience of typical requirements concerning the areas, serve as general guidance and cannot be estimated as binding statements about the suitability for a customer application. The responsibility for the applicability and use in a particular customer design is always solely within the authority of the customer. Due to this fact it is up to the customer to evaluate, where appropriate to investigate and decide whether the device with the specific product characteristics described in the product specification is valid and suitable for the respective customer application or not.

2. Customer Responsibility related to Specific, in particular Safety-Relevant Applications

It has to be clearly pointed out that the possibility of a malfunction of electronic components or failure before the end of the usual lifetime cannot be completely eliminated in the current state of the art, even if the products are operated within the range of the specifications. In certain customer applications requiring a very high level of safety and especially in customer applications in which the malfunction or failure of an electronic component could endanger human life or health it must be ensured by most advanced technological aid of suitable design of the customer application that no injury or damage is caused to third parties in the event of malfunction or failure of an electronic component. Therefore, customer is cautioned to verify that data sheets are current before placing orders. The current data sheets can be downloaded at www.we-online.com.

3. Best Care and Attention

Any product-specific notes, cautions and warnings must be strictly observed. Any disregard will result in the loss of warranty.

4. Customer Support for Product Specifications

Some products within the product range may contain substances which are subject to restrictions in certain jurisdictions in order to serve specific technical requirements. Necessary information is available on request. In this case the field sales engineer or the internal sales person in charge should be contacted who will be happy to support in this matter.

5. Product R&D

Due to constant product improvement product specifications may change from time to time. As a standard reporting procedure of the Product Change Notification (PCN) according to the JEDEC-Standard inform about minor and major changes. In case of further queries regarding the PCN, the field sales engineer or the internal sales person in charge should be contacted. The basic responsibility of the customer as per Section 1 and 2 remains unaffected.

6. Product Life Cycle



Due to technical progress and economical evaluation we also reserve the right to discontinue production and delivery of products. As a standard reporting procedure of the Product Termination Notification (PTN) according to the JEDEC-Standard we will inform at an early stage about inevitable product discontinuance. According to this we cannot guarantee that all products within our product range will always be available. Therefore it needs to be verified with the field sales engineer or the internal sales person in charge about the current product availability expectancy before or when the product for application design-in disposal is considered. The approach named above does not apply in the case of individual agreements deviating from the foregoing for customer-specific products.

7. Property Rights

All the rights for contractual products produced by Würth Elektronik eiSos GmbH & Co. KG on the basis of ideas, development contracts as well as models or templates that are subject to copyright, patent or commercial protection supplied to the customer will remain with Würth Elektronik eiSos GmbH & Co. KG. Würth Elektronik eiSos GmbH & Co. KG does not warrant or represent that any license, either expressed or implied, is granted under any patent right, copyright, mask work right, or other intellectual property right relating to any combination, application, or process in which Würth Elektronik eiSos GmbH & Co. KG components or services are used.

8. General Terms and Conditions

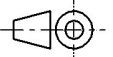
Unless otherwise agreed in individual contracts, all orders are subject to the current version of the "General Terms and Conditions of Würth Elektronik eiSos Group", last version available at www.we-online.com.

Würth Elektronik eiSos GmbH & Co. KG EMC & Inductive Solutions Max-Eyth-Str. 1 74638 Waldenburg Germany Tel. +49 (0) 79 42 945 - 0 www.we-online.com eiSos@we-online.com		CREATED KaS	CHECKED RoD	GENERAL TOLERANCE DIN ISO 2768-1m	PROJECTION METHOD 	
		DESCRIPTION WE-TVS TVS Diode – Super Speed Series			ORDER CODE 824014881	
		SIZE DFN3810-9L	REVISION 001.000	STATUS Valid	DATE (YYYY-MM-DD) 2017-07-13	BUSINESS UNIT eiSos



Компания «ЭлектроПласт» предлагает заключение долгосрочных отношений при поставках импортных электронных компонентов на взаимовыгодных условиях!

Наши преимущества:

- Оперативные поставки широкого спектра электронных компонентов отечественного и импортного производства напрямую от производителей и с крупнейших мировых складов;
- Поставка более 17-ти миллионов наименований электронных компонентов;
- Поставка сложных, дефицитных, либо снятых с производства позиций;
- Оперативные сроки поставки под заказ (от 5 рабочих дней);
- Экспресс доставка в любую точку России;
- Техническая поддержка проекта, помощь в подборе аналогов, поставка прототипов;
- Система менеджмента качества сертифицирована по Международному стандарту ISO 9001;
- Лицензия ФСБ на осуществление работ с использованием сведений, составляющих государственную тайну;
- Поставка специализированных компонентов (Xilinx, Altera, Analog Devices, Intersil, Interpoint, Microsemi, Aeroflex, Peregrine, Syfer, Eurofarad, Texas Instrument, Miteq, Cobham, E2V, MA-COM, Hittite, Mini-Circuits, General Dynamics и др.);

Помимо этого, одним из направлений компании «ЭлектроПласт» является направление «Источники питания». Мы предлагаем Вам помощь Конструкторского отдела:

- Подбор оптимального решения, техническое обоснование при выборе компонента;
- Подбор аналогов;
- Консультации по применению компонента;
- Поставка образцов и прототипов;
- Техническая поддержка проекта;
- Защита от снятия компонента с производства.



Как с нами связаться

Телефон: 8 (812) 309 58 32 (многоканальный)

Факс: 8 (812) 320-02-42

Электронная почта: org@eplast1.ru

Адрес: 198099, г. Санкт-Петербург, ул. Калинина, дом 2, корпус 4, литера А.