

## 75 dB, FAST SETTLING, LOGARITHMIC DETECTOR / CONTROLLER 10 - 4000 MHz



### Typical Applications

The HMC601LP4(E) is ideal for IF and RF applications in:

- Cellular/PCS/3G
- WiMAX, WiBro & Fixed Wireless
- Power Monitoring & Control Circuitry
- Receiver Signal Strength Indication (RSSI)
- Automatic Gain & Power Control Circuits

### Features

- Wide Dynamic Range: up to 75 dB
- Fast Pulse Response: 15/34ns (Rise/Fall Time)
- Flexible Supply Voltage: +2.7V to +5.5V
- Power-Down Mode
- Excellent Stability over Temperature
- Compact 4x4mm Leadless SMT Package

### Functional Diagram

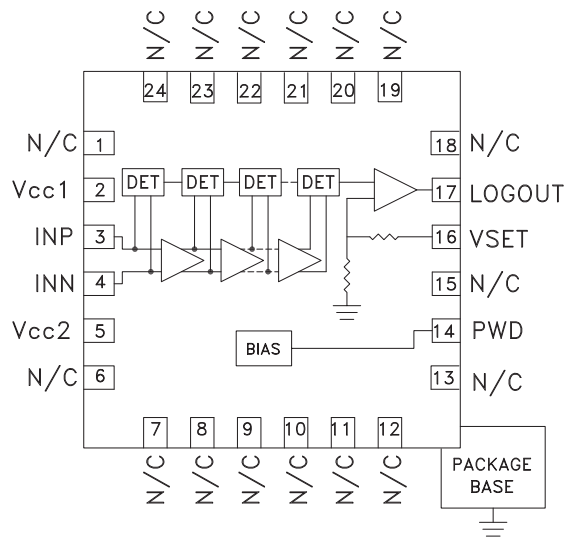

### General Description

The HMC601LP4(E) Logarithmic Detector/Controller converts RF signals at its input, to a proportional DC voltage at its output. The HMC601LP4(E) employ a successive compression topology which delivers extremely high dynamic range and conversion accuracy over a wide input frequency range. As the input power is increased, successive amplifiers move into saturation one by one creating an accurate approximation of the logarithm function. The output of a series of square law detectors is summed, converted into voltage domain and buffered to drive the LOGOUT output. For detection mode, the LOGOUT pin is shorted to the VSET input, and will provide a nominal logarithmic slope of 19mV/dB and an intercept of -100dBm. The HMC601LP4(E) can also be used in the controller mode where an external voltage is applied to the VSET pin, to create an AGC or APC feedback loop. The HMC601LP4(E) provides a 15/34ns (rise/fall time) response time enabling RF burst detection to a pulse rate beyond 20 MHz.

### Electrical Specifications, $T_A = +25C$ , $PWD = 0V$ , $V_{cc1}$ , $V_{cc2} = +3.3V$ [1]

Parameter	Typ.	Typ.	Typ.	Typ.	Typ.	Typ.	Typ.	Typ.	Units
Input Frequency	50	100	500	900	1900	2500	3500	4000	MHz
$\pm 3$ dB Dynamic Range	74	74	74	74	70	68	54	52	dB
$\pm 3$ dB Dynamic Range Center	-31	-31	-31	-31	-31.5	-31.5	-27	-23	dBm
$\pm 1$ dB Dynamic Range	68	68	69	69	67	65	47	46	dB
Output Slope	19.5	19.4	19.2	19.1	19.0	19.4	20.9	19.6	mV/dB
Output Intercept	-99	-99	-100	-100	-98	-96	-85	-79	dBm
Temperature Sensitivity @ -10 dBm Input [2]	-4.2	-3.8	-3.5	-2.4	-0.8	-0.8	-4.4	-3.5	mdB/ $^{\circ}C$

[1] Detector mode measurements; LOGOUT (Pin 17) is shorted to VSET (Pin 16).

[2] Measured from  $T_A = -40C$  to  $T_A = +85C$

Parameter	Conditions	Min.	Typ.	Max.	Units
<b>RF Input (INP)</b>					
Return Loss	F = 10 - 4000 MHz, $Z_o = 50\Omega$ , See plot		10		dB
<b>LOGOUT Interface</b>					
Open Loop Impedance	(Simulated)		12		k $\Omega$

Information furnished by Analog Devices is believed to be accurate and reliable. However, no responsibility is assumed by Analog Devices for its use, nor for any infringements of patents or other rights of third parties that may result from its use. Specifications subject to change without notice. No license is granted by implication or otherwise under any patent or patent rights of Analog Devices. Trademarks and registered trademarks are the property of their respective owners.

For price, delivery, and to place orders: Analog Devices, Inc., One Technology Way, P.O. Box 9106, Norwood, MA 02062-9106 Phone: 781-329-4700 • Order online at [www.analog.com](http://www.analog.com) Application Support: Phone: 1-800-ANALOG-D

## 75 dB, FAST SETTLING, LOGARITHMIC DETECTOR / CONTROLLER 10 - 4000 MHz



### Electrical Specifications, (continued)

Parameter	Conditions	Min.	Typ.	Max.	Units
Current Drive (Source)			0.55		mA
Current Drive (Sink)	For 1% change in the output voltage		4.8		mA
Output Voltage Range		0		V <sub>CC</sub> -0.13	V
Small Signal Response Time (10% to 90%)	Pin = -60 to -57 dBm		8		ns
Large Signal Response Time (±0.5 dB Settling)	Pin = No Signal to 0 dBm		50		ns
Output Rise Time	From 0% to 90%		15		ns
Ripple	Fin = 100 MHz		<4		mVpp
<b>VSET Interface</b>					
Input Impedance			30		kΩ
Input Voltage Range			0.6 to 1.9		V
Low Frequency Gain	VSET to LOGOUT		75		dB
Open Loop Corner Frequency			4.4		kHz
<b>Power Down (PWD) Interface</b>					
Voltage Range for Normal Mode		0		0.2 x V <sub>CC</sub>	V
Voltage Range for Shutdown Mode		0.8 x V <sub>CC</sub>		V <sub>CC</sub>	V
Threshold Voltage			V <sub>CC</sub> /2		V
Power-up Response Time	50% PWD to ±0.5 dB Settling of LOGOUT		19.9		μs
Power-Down Response Time	50% PWD to 10% I <sub>CC</sub>		2.2		μs
<b>Power Supply (V<sub>CC1</sub>, V<sub>CC2</sub>)</b>					
Operating Voltage Range		2.7		5.5	V
Supply Current in Normal Mode	V <sub>CC</sub> = +3.3V, PWD = 0V		30	36	mA
Supply Current in Power Down Mode	V <sub>CC</sub> = +3.3V, PWD = V <sub>CC</sub>		1		mA

### Test Conditions

Parameter	Condition
V <sub>CC1</sub> , V <sub>CC2</sub>	+3.3V
Input Z <sub>o</sub>	50Ω
T <sub>A</sub>	+25°C
Fin	900 MHz

INN Port connected to ground through a 1000pF capacitor

**LOGOUT Voltage & Error vs. Input Power, Fin = 10 MHz**

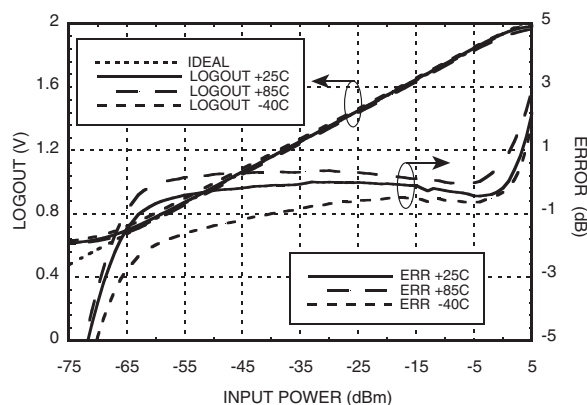

**LOGOUT Voltage & Error vs. Input Power, Fin = 50 MHz**

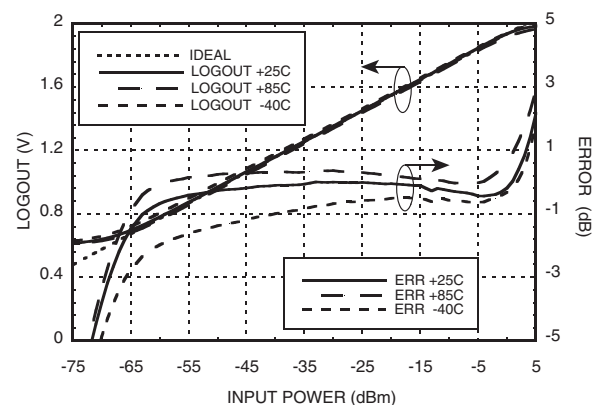

Unless otherwise noted: V<sub>CC1</sub>, V<sub>CC2</sub> = +3.3V, T<sub>A</sub> = +25°C

Information furnished by Analog Devices is believed to be accurate and reliable. However, no responsibility is assumed by Analog Devices for its use, nor for any infringements of patents or other rights of third parties that may result from its use. Specifications subject to change without notice. No license is granted by implication or otherwise under any patent or patent rights of Analog Devices. Trademarks and registered trademarks are the property of their respective owners.

For price, delivery, and to place orders: Analog Devices, Inc., One Technology Way, P.O. Box 9106, Norwood, MA 02062-9106 Phone: 781-329-4700 • Order online at [www.analog.com](http://www.analog.com) Application Support: Phone: 1-800-ANALOG-D

**75 dB, FAST SETTLING, LOGARITHMIC DETECTOR / CONTROLLER 10 - 4000 MHz**



**LOGOUT Voltage & Error vs. Input Power,  $f_{in} = 100$  MHz**

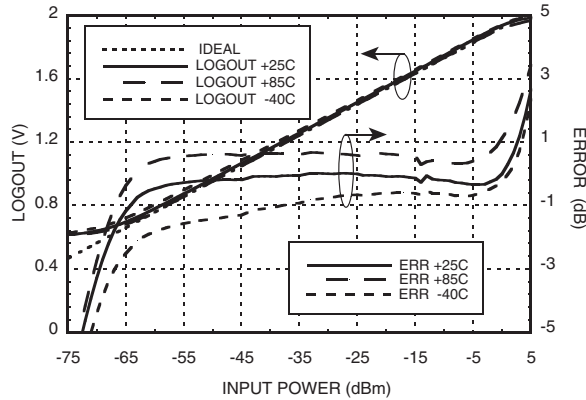

**LOGOUT Voltage & Error vs. Input Power,  $f_{in} = 500$  MHz**

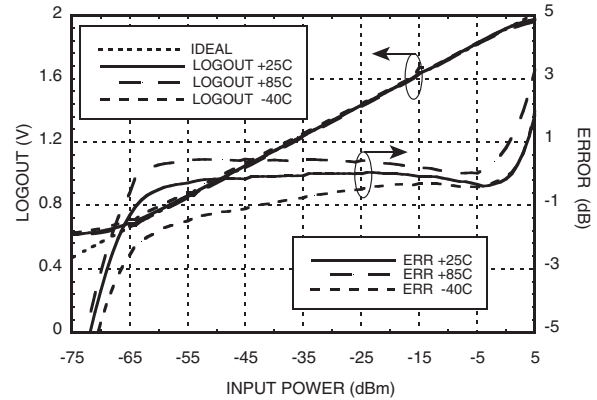

**LOGOUT Voltage & Error vs. Input Power,  $f_{in} = 900$  MHz**

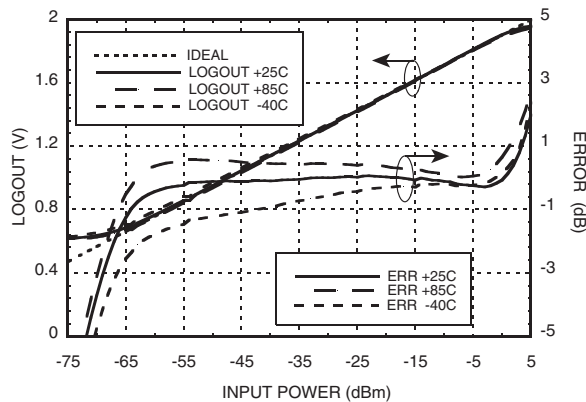

**LOGOUT Voltage & Error vs. Input Power,  $f_{in} = 1900$  MHz**

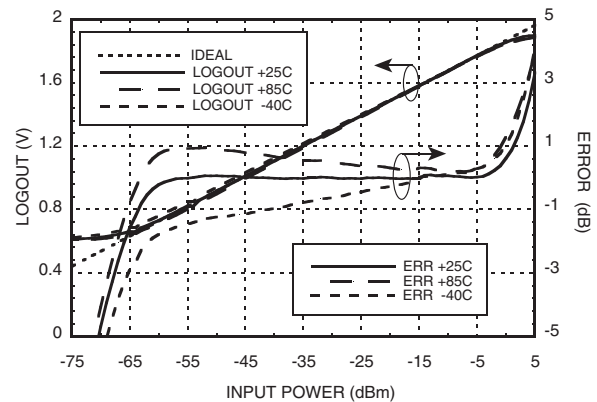

**LOGOUT Voltage & Error vs. Input Power,  $f_{in} = 2500$  MHz**

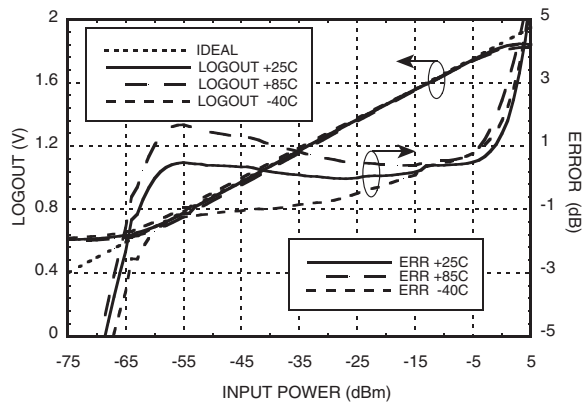

**LOGOUT Voltage & Error vs. Input Power,  $f_{in} = 3500$  MHz**

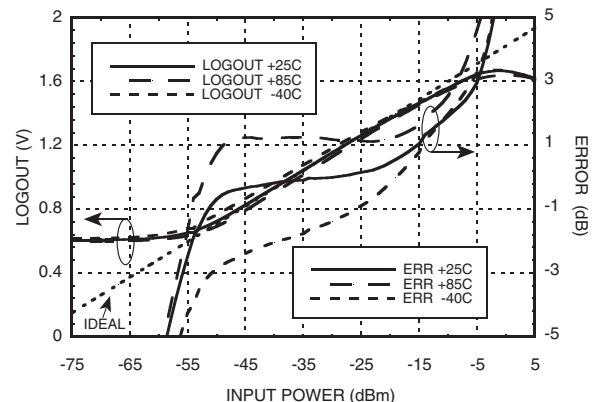

Unless otherwise noted:  $V_{cc1}, V_{cc2} = +3.3V, T_A = +25C$

Information furnished by Analog Devices is believed to be accurate and reliable. However, no responsibility is assumed by Analog Devices for its use, nor for any infringements of patents or other rights of third parties that may result from its use. Specifications subject to change without notice. No license is granted by implication or otherwise under any patent or patent rights of Analog Devices. Trademarks and registered trademarks are the property of their respective owners.

For price, delivery, and to place orders: Analog Devices, Inc., One Technology Way, P.O. Box 9106, Norwood, MA 02062-9106 Phone: 781-329-4700 • Order online at [www.analog.com](http://www.analog.com) Application Support: Phone: 1-800-ANALOG-D

**75 dB, FAST SETTLING, LOGARITHMIC DETECTOR / CONTROLLER 10 - 4000 MHz**



**LOGOUT Voltage & Error vs. Input Power,  $F_{in} = 4000$  MHz**

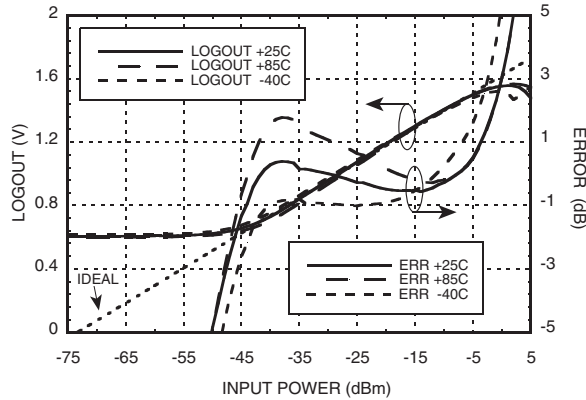

**LOGOUT Slope vs. Frequency,  $V_{cc} = 3.3V$**

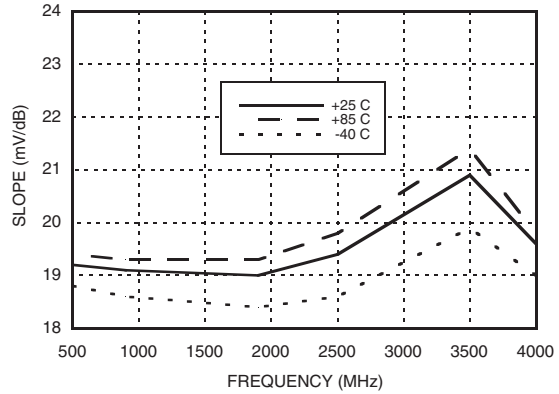

**LOGOUT Slope vs. Supply Voltage,  $T_A = +25C$**

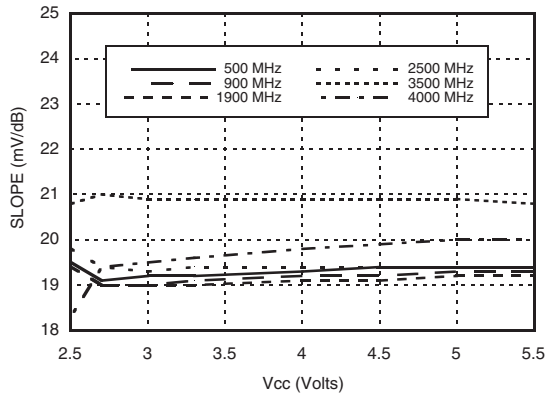

**LOGOUT Intercept vs. Frequency,  $V_{cc} = 3.3V$**

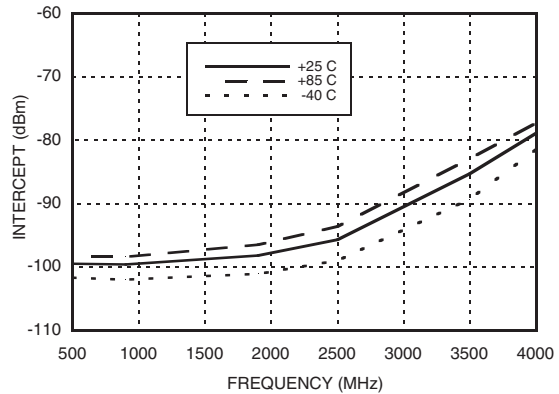

**LOGOUT Intercept vs. Supply Voltage  $T_A = +25C$**

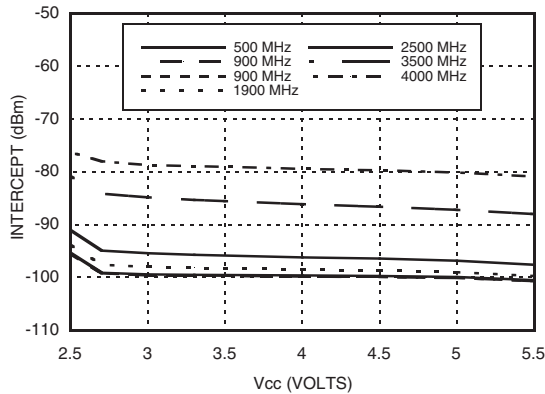

**LOGOUT Error vs. Input Power, Normalized [2],  $F_{in} = 1900$  MHz**

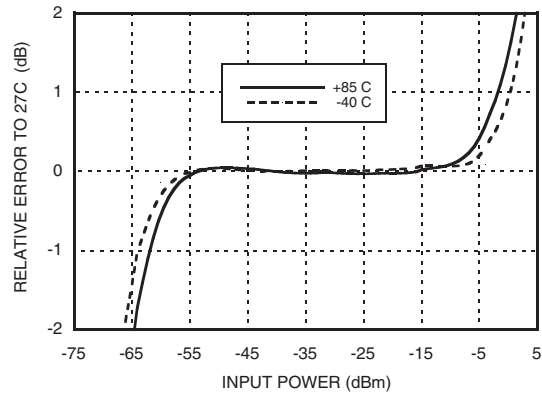

Unless otherwise noted:  $V_{cc1}, V_{cc2} = +3.3V, T_A = +25C$

Information furnished by Analog Devices is believed to be accurate and reliable. However, no responsibility is assumed by Analog Devices for its use, nor for any infringements of patents or other rights of third parties that may result from its use. Specifications subject to change without notice. No license is granted by implication or otherwise under any patent or patent rights of Analog Devices. Trademarks and registered trademarks are the property of their respective owners.

For price, delivery, and to place orders: Analog Devices, Inc., One Technology Way, P.O. Box 9106, Norwood, MA 02062-9106 Phone: 781-329-4700 • Order online at [www.analog.com](http://www.analog.com) Application Support: Phone: 1-800-ANALOG-D



**75 dB, FAST SETTLING, LOGARITHMIC DETECTOR / CONTROLLER 10 - 4000 MHz**

**Input Return Loss vs. Frequency**

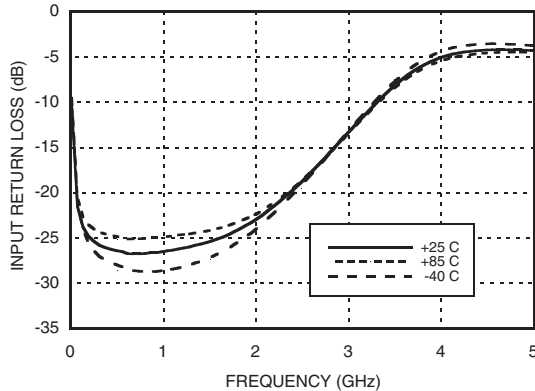

**LOGOUT Voltage vs. Input Power & Frequency, T<sub>A</sub> = +25C**

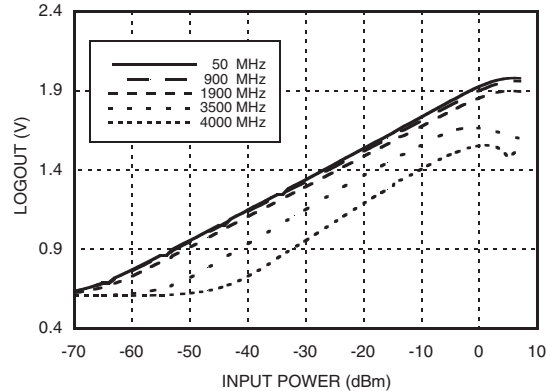

**Absolute Maximum Ratings**

Vcc1, Vcc2	0V to +5.5V
PWD	0V to +5.5V
VSET Input Voltage	0V to +5.5V
LOGOUT Output Current	3 mA
RF Input Power	+12 dBm
Junction Temperature	125 °C
Continuous Pdiss (T = 85°C) (Derate 7.95 mW/°C above 85°C)	0.32 Watts
Thermal Resistance (R <sub>th</sub> ) (junction to lead)	126 °C/W
Storage Temperature	-65 to +150 °C
Operating Temperature	-40 to +85 °C
ESD Sensitivity (HBM)	Class 1C



**ELECTROSTATIC SENSITIVE DEVICE  
OBSERVE HANDLING PRECAUTIONS**

[1] Unless otherwise noted: Vcc1, Vcc2 = +3.3V, T<sub>A</sub> = +25C  
[2] This data is relative to the room temperature performance of the HMC601LP4

**Outline Drawing**

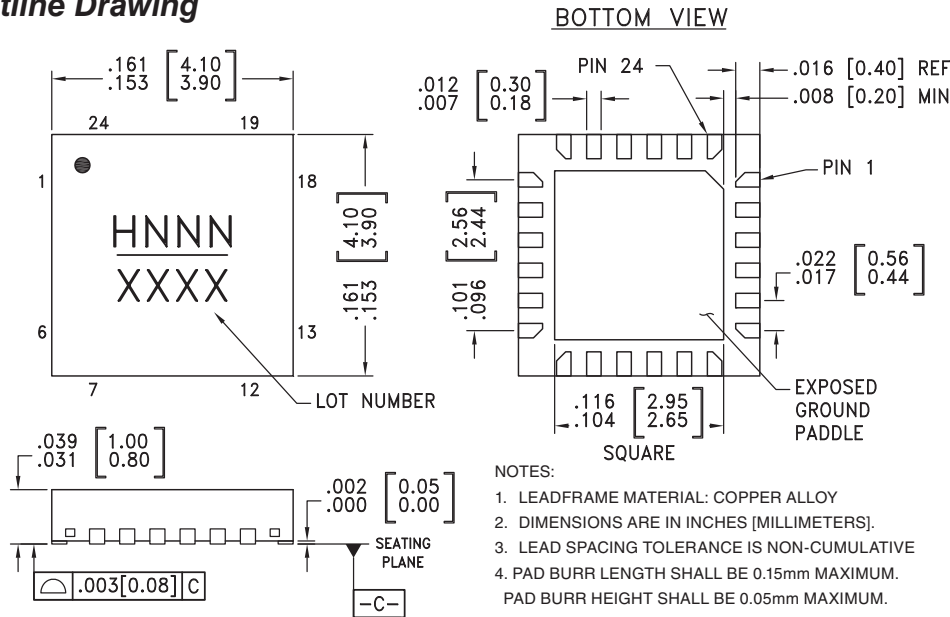

**NOTES:**

- LEADFRAME MATERIAL: COPPER ALLOY
- DIMENSIONS ARE IN INCHES [MILLIMETERS].
- LEAD SPACING TOLERANCE IS NON-CUMULATIVE
- PAD BURR LENGTH SHALL BE 0.15mm MAXIMUM.  
PAD BURR HEIGHT SHALL BE 0.05mm MAXIMUM.
- PACKAGE WARP SHALL NOT EXCEED 0.05mm.
- ALL GROUND LEADS AND GROUND PADDLE MUST BE SOLDERED TO PCB RF GROUND.
- REFER TO HITTITE APPLICATION NOTE FOR SUGGESTED PCB LAND PATTERN.



### Package Information



Part Number	Package Body Material	Lead Finish	MSL Rating	Package Marking <sup>[3]</sup>
HMC601LP4	Low Stress Injection Molded Plastic	Sn/Pb Solder	MSL1 <sup>[1]</sup>	H601 XXXX
HMC601LP4E	RoHS-compliant Low Stress Injection Molded Plastic	100% matte Sn	MSL1 <sup>[2]</sup>	H601 XXXX

[1] Max peak reflow temperature of 235 °C

[2] Max peak reflow temperature of 260 °C

[3] 4-Digit lot number XXXX

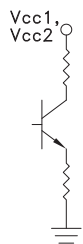
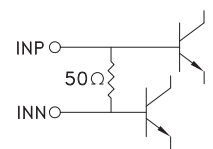
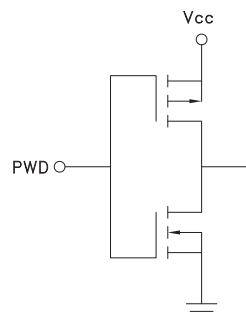
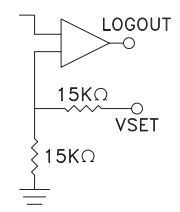
### Pin Descriptions

Pin Number	Function	Description	Interface Schematic
1, 6, 7-13, 15, 18-24	N/C	These pins are not connected internally; however, this product is specified with these pins connected to RF/DC ground.	
2, 5	Vcc1, Vcc2	Bias supply. Connect supply voltage to both pins.	
3, 4	INP, INN	RF Input pins. Connect RF to INP, and AC couple INN to ground for single-ended operation.	
14	PWD	Apply PWD >0.8xVcc to initiate a power saving shutdown mode.  To ensure proper start-up apply the power-up sequence shown in the "Power-Up Timing Diagram" attached to the application circuit.	
16	VSET	VSET input in controller mode. Short this pin to LOGOUT for detector mode.	
17	LOGOUT	Logarithmic output that converts the input power to a DC level in detector mode. Short this pin to VSET for detector mode.	
Package Base	GND	Exposed paddle must be connected to RF and DC ground.	

Information furnished by Analog Devices is believed to be accurate and reliable. However, no responsibility is assumed by Analog Devices for its use, nor for any infringements of patents or other rights of third parties that may result from its use. Specifications subject to change without notice. No license is granted by implication or otherwise under any patent or patent rights of Analog Devices. Trademarks and registered trademarks are the property of their respective owners.

For price, delivery, and to place orders: Analog Devices, Inc.,  
One Technology Way, P.O. Box 9106, Norwood, MA 02062-9106  
Phone: 781-329-4700 • Order online at [www.analog.com](http://www.analog.com)  
Application Support: Phone: 1-800-ANALOG-D

**75 dB, FAST SETTLING, LOGARITHMIC DETECTOR / CONTROLLER 10 - 4000 MHz**



**Evaluation PCB**

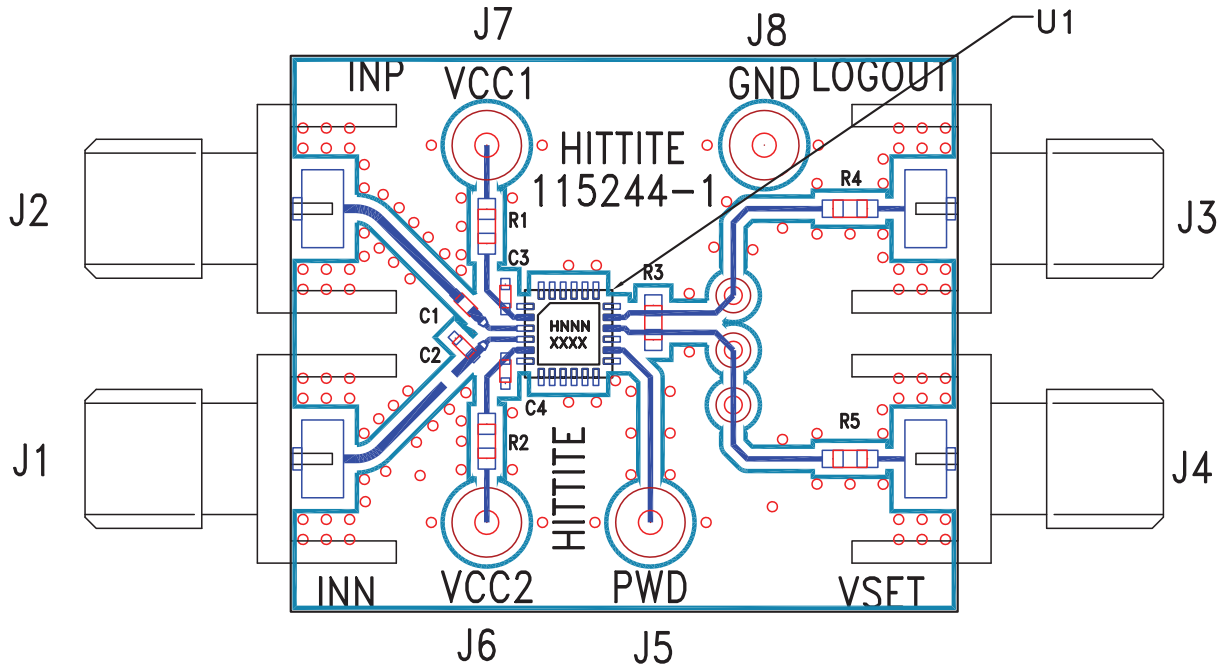

**List of Materials for Evaluation PCB 115242 [1]**

Item	Description
J1 - J4	PC Mount SMA Connector
J5 - J8	DC Pin
C1, C2	1000 pF Capacitor, 0402 Pkg.
C3, C4	0.1µF Capacitor, 0402 Pkg.
R1, R2	5.6Ω Resistor, 0603 Pkg.
R3-R5	0Ω Resistor, 0603 Pkg.
U1	HMC601LP4 / HMC601LP4E Logarithmic Detector / Controller
PCB [2]	115244 Evaluation PCB

The circuit board used in the final application should use RF circuit design techniques. Signal lines should have 50 ohm impedance while the package ground leads and exposed paddle should be connected directly to the ground plane similar to that shown. A sufficient number of via holes should be used to connect the top and bottom ground planes. The evaluation circuit board shown is available from Hittite upon request.

[1] Reference this number when ordering complete evaluation PCB

[2] Circuit Board Material: Rogers 4350





**Application & Evaluation PCB Schematic**

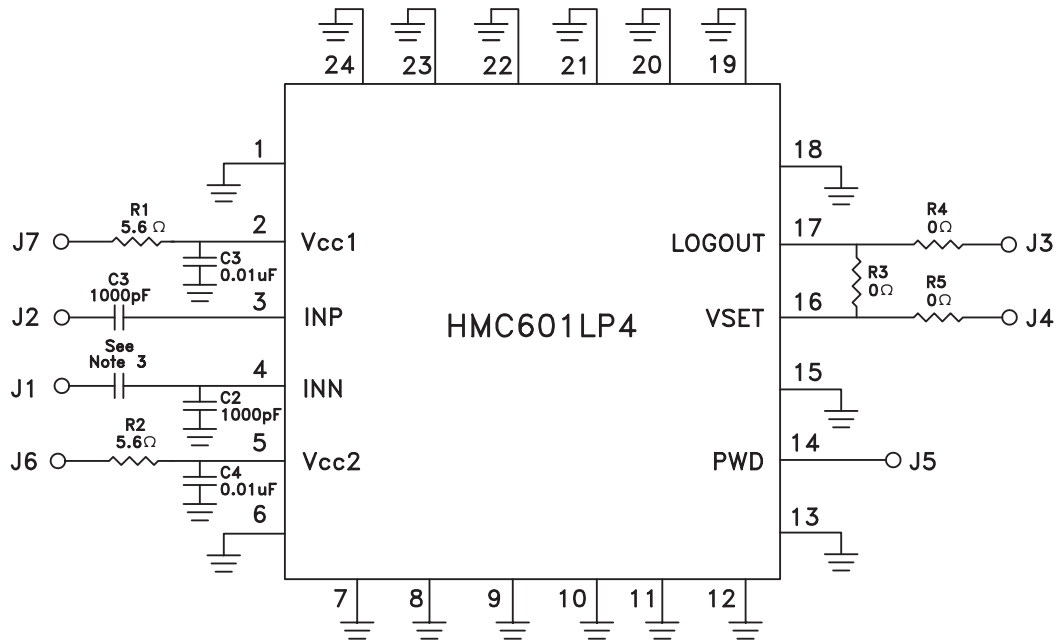

**Notes**

- Note 1: The HMC601LP4 & HMC601LP4E evaluation boards are pre-assembled for single-ended input, and detector/RSSI mode.
- Note 2: For single-ended input operation, use the INP port and make no connection to INN. INN is AC coupled to ground by C2
- Note 3: For differential input, remove C2, and install a 1000pF capacitor in series with INN at location shown.
- Note 4: For detector mode, connect high impedance volt meter to the LOGOUT port, and make no connection to VSET. LOGOUT is shorted to VSET by R3, as required for detector mode.
- Note 5: For controller mode, remove R3 and make appropriate connection to LOGOUT and VSET. In controller mode, the LOGOUT output can be used to drive a variable gain amplifier, or a variable attenuator, either directly or through a buffer or microcontroller. VSET should be connected to an external supply, typically between +0.6 and +1.9V.

**Power-Up Timing Diagram**

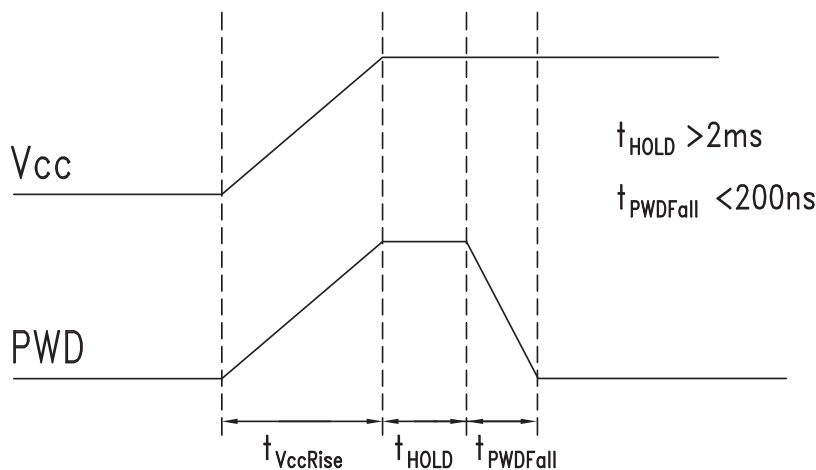

Information furnished by Analog Devices is believed to be accurate and reliable. However, no responsibility is assumed by Analog Devices for its use, nor for any infringements of patents or other rights of third parties that may result from its use. Specifications subject to change without notice. No license is granted by implication or otherwise under any patent or patent rights of Analog Devices. Trademarks and registered trademarks are the property of their respective owners.

For price, delivery, and to place orders: Analog Devices, Inc., One Technology Way, P.O. Box 9106, Norwood, MA 02062-9106 Phone: 781-329-4700 • Order online at [www.analog.com](http://www.analog.com) Application Support: Phone: 1-800-ANALOG-D





Компания «ЭлектроПласт» предлагает заключение долгосрочных отношений при поставках импортных электронных компонентов на взаимовыгодных условиях!

Наши преимущества:

- Оперативные поставки широкого спектра электронных компонентов отечественного и импортного производства напрямую от производителей и с крупнейших мировых складов;
- Поставка более 17-ти миллионов наименований электронных компонентов;
- Поставка сложных, дефицитных, либо снятых с производства позиций;
- Оперативные сроки поставки под заказ (от 5 рабочих дней);
- Экспресс доставка в любую точку России;
- Техническая поддержка проекта, помощь в подборе аналогов, поставка прототипов;
- Система менеджмента качества сертифицирована по Международному стандарту ISO 9001;
- Лицензия ФСБ на осуществление работ с использованием сведений, составляющих государственную тайну;
- Поставка специализированных компонентов (Xilinx, Altera, Analog Devices, Intersil, Interpoint, Microsemi, Aeroflex, Peregrine, Syfer, Eurofarad, Texas Instrument, Miteq, Cobham, E2V, MA-COM, Hittite, Mini-Circuits, General Dynamics и др.);

Помимо этого, одним из направлений компании «ЭлектроПласт» является направление «Источники питания». Мы предлагаем Вам помощь Конструкторского отдела:

- Подбор оптимального решения, техническое обоснование при выборе компонента;
- Подбор аналогов;
- Консультации по применению компонента;
- Поставка образцов и прототипов;
- Техническая поддержка проекта;
- Защита от снятия компонента с производства.



#### Как с нами связаться

**Телефон:** 8 (812) 309 58 32 (многоканальный)

**Факс:** 8 (812) 320-02-42

**Электронная почта:** [org@eplast1.ru](mailto:org@eplast1.ru)

**Адрес:** 198099, г. Санкт-Петербург, ул. Калинина, дом 2, корпус 4, литера А.