

## GaAs MMIC 5 WATT T/R SWITCH DC - 3 GHz

### Typical Applications

The HMC574AMS8E is ideal for:

- Cellular/3G Infrastructure
- Private Mobile Radio Handsets
- WLAN, WiMAX & WiBro
- Automotive Telematics
- Test Equipment

### Features

- Low Insertion Loss: 0.3 dB
- High Third Order Intercept: +63 dBm
- Isolation: 30 dB
- Single Positive Supply: +3 to +8V
- SMT Package: MSOP8

### Functional Diagram

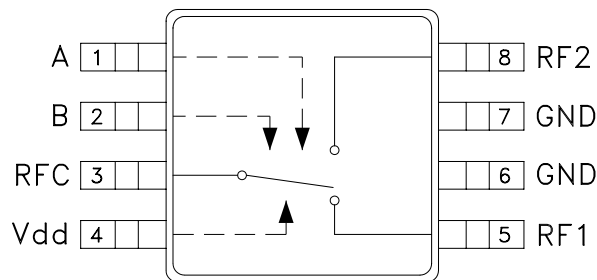

### General Description

The HMC574AMS8E is low-cost SPDT switch in 8-lead MSOP packages for use in transmit/receive applications which requires very low distortion at high incident power levels. The device can control signals from DC to 3 GHz and is especially suited for Cellular/3G infrastructure, WiMAX and WiBro applications with only 0.3 dB typical insertion loss. The design provides 5 watt power handling performance and +63 dBm third order intercept at +8 Volt bias. RF1 and RF2 are reflective shorts when "Off".

### Electrical Specifications,

$T_A = +25^\circ \text{C}$ ,  $V_{ctl} = 0/+5 \text{ Vdc}$ ,  $V_{dd} = +5 \text{ Vdc}$  (Unless Otherwise Stated), 50 Ohm System

Parameter	Frequency	Min.	Typ.	Max.	Units
Insertion Loss	DC - 1.0 GHz		0.25	0.5	dB
	DC - 2.0 GHz		0.3	0.6	dB
	DC - 2.5 GHz		0.4	0.7	dB
	DC - 3.0 GHz		0.5	0.8	dB
Isolation	DC - 1.0 GHz	26	30		dB
	DC - 2.0 GHz	24	28		dB
	DC - 2.5 GHz	21	25		dB
	DC - 3.0 GHz	16	20		dB
Return Loss	DC - 1.0 GHz		35		dB
	DC - 2.0 GHz		30		dB
	DC - 2.5 GHz		25		dB
	DC - 3.0 GHz		22		dB
Input Power for 1dB Compression	0.5 - 3.0 GHz	$V_{ctl} = 0/+3V$	31	34	dBm
		$V_{ctl} = 0/+5V$	35	38	dBm
		$V_{ctl} = 0/+8V$	37	39	dBm
Input Third Order Intercept $P_{tone}$ = Two-tone Input Power (Each Tone)	0.5 - 3.0 GHz	$V_{ctl} = 0/+3V$ , $P_{tone} = +23 \text{ dBm}$		63	dBm
		$V_{ctl} = 0/+5V$ , $P_{tone} = +27 \text{ dBm}$		63	dBm
		$V_{ctl} = 0/+8V$ , $P_{tone} = +27 \text{ dBm}$		63	dBm
Switching Characteristics	DC - 3.0 GHz	$t_{RISE}, t_{FALL}$ (10/90% RF)		40	ns
		$t_{ON}, t_{OFF}$ (50% CTL to 10/90% RF)		70	ns

**GaAs MMIC 5 WATT T/R SWITCH  
DC - 3 GHz**

**Insertion Loss**

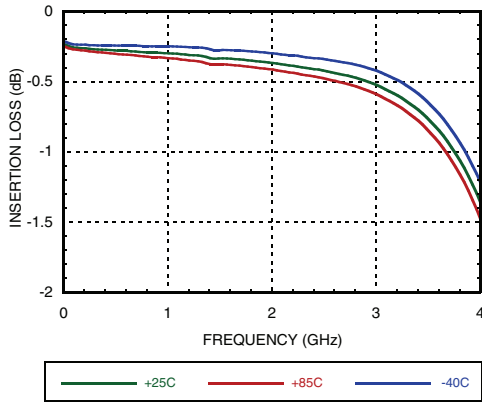

**Isolation Between RFC & RF1/RF2**

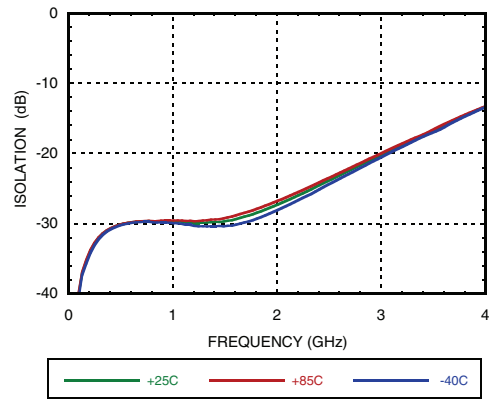

**RF1 to RF2 Isolation**

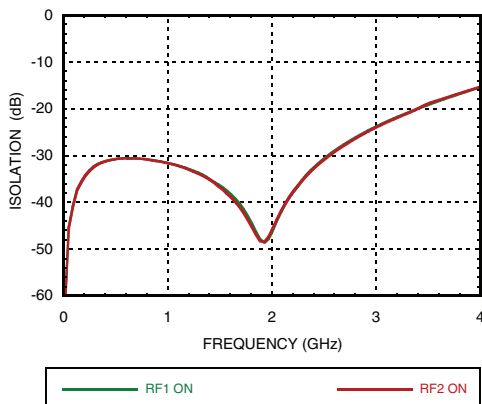

**Return Loss**

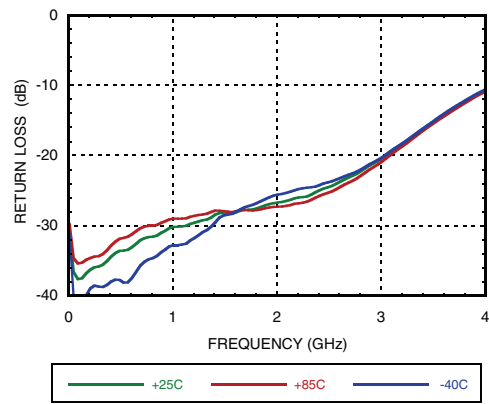

**Input P0.1dB vs. Vdd**

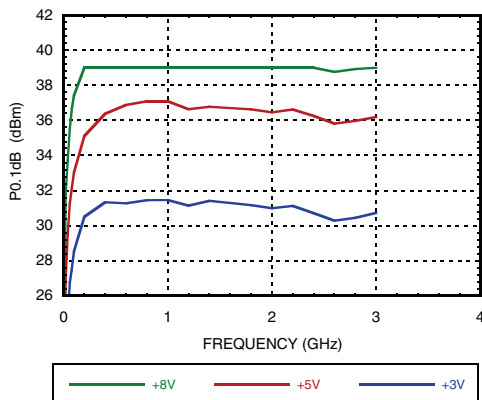

**Input P1dB vs. Vdd**

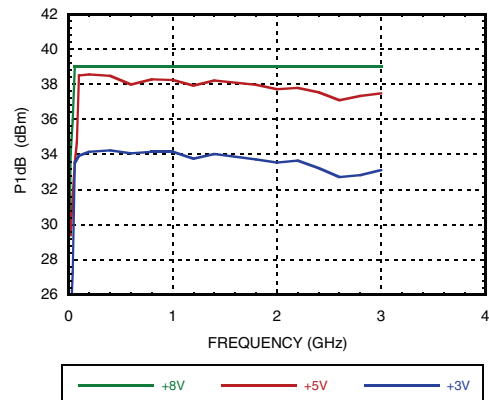

**GaAs MMIC 5 WATT T/R SWITCH  
DC - 3 GHz**

**Input IP3 vs. Input Power @ 900 MHz**

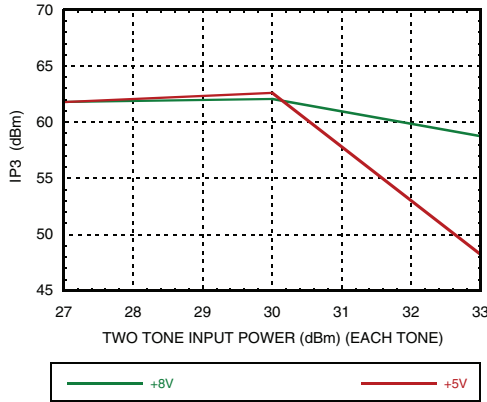

**Input IP3 vs. Input Power @ 1900 MHz**

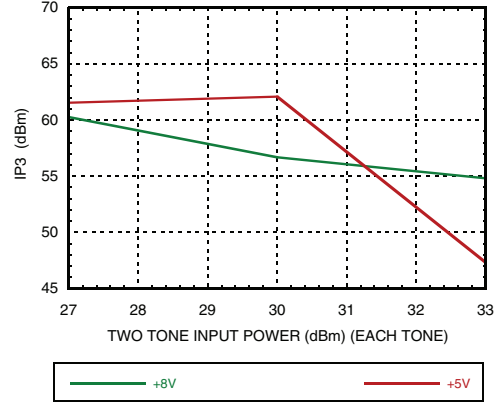

**Input Third Order Intercept**

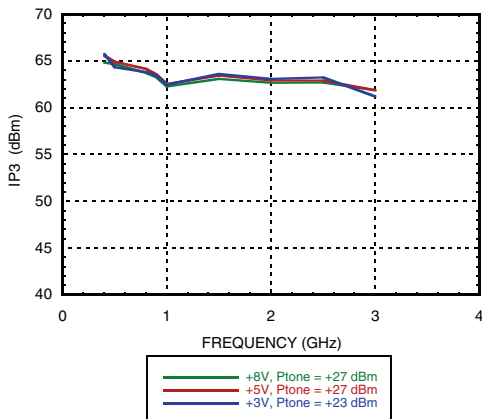

**2nd & 3rd Harmonics @ 900 MHz  
Vdd = +3 Volts**

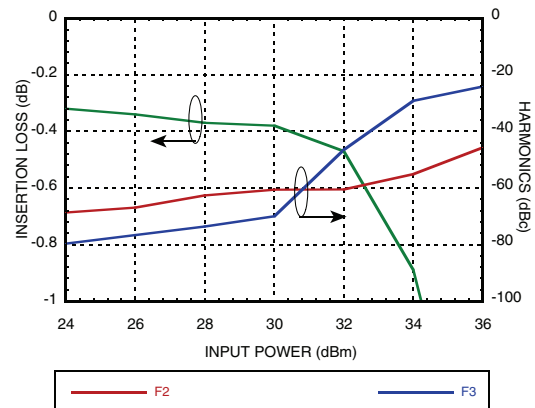

**2nd & 3rd Harmonics @ 900 MHz  
Vdd = +5 Volts**

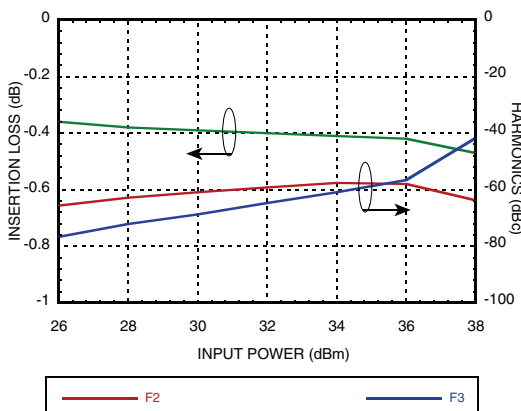

**2nd & 3rd Harmonics @ 900 MHz  
Vdd = +8 Volts**

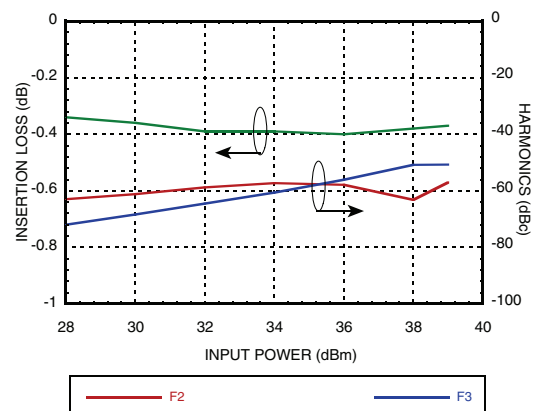

## GaAs MMIC 5 WATT T/R SWITCH DC - 3 GHz

**Input P0.1dB vs. Vdd**

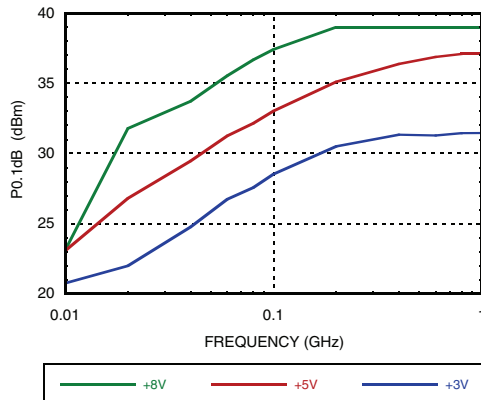

**Input P1dB vs. Vdd**

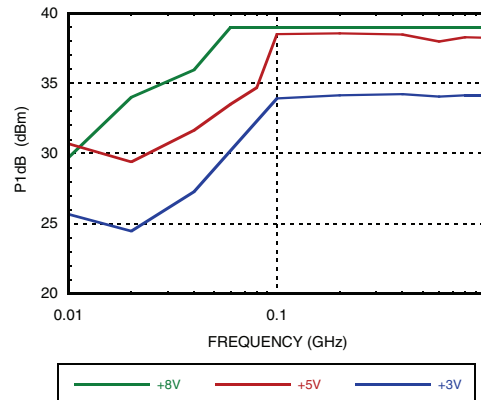

### Absolute Maximum Ratings

Max. Input Power $V_{dd} = 0/+8V$	0.5 - 2.5 GHz	39 dBm
Bias Voltage Range (Vdd)		-0.2 to +10 Vdc
Control Voltage Range (A & B)		-0.2 to +Vdd Vdc
Channel Temperature		150 °C
Continuous P <sub>diss</sub> ( T= + 85 °C) (derate 10 mW/°C above 85 °C)		0.775W
Thermal Resistance		83.9 °C/W
Storage Temperature		-65 to +150 °C
Operating Temperature		-40 to +85 °C
ESD Sensitivity (HBM)		Class 1A

DC Blocks are required at ports RFC, RF1 and RF2

### Bias Voltage & Current

Vdd (Vdc)	Typical I <sub>dd</sub> (µA)
+3	0.5
+5	1
+8	20

### Control Voltages

State	Bias Condition
Low	0 to +0.2 Vdc @ 1 µA Typical
High	Vdd ± 0.2 Vdc @ 1 µA Typical



**ELECTROSTATIC SENSITIVE DEVICE  
OBSERVE HANDLING PRECAUTIONS**

### Truth Table

Control Input (Vctl)		Signal Path State	
A	B	RFC to RF1	RFC to RF2
High	Low	Off	On
Low	High	On	Off

## GaAs MMIC 5 WATT T/R SWITCH DC - 3 GHz

### Outline Drawing

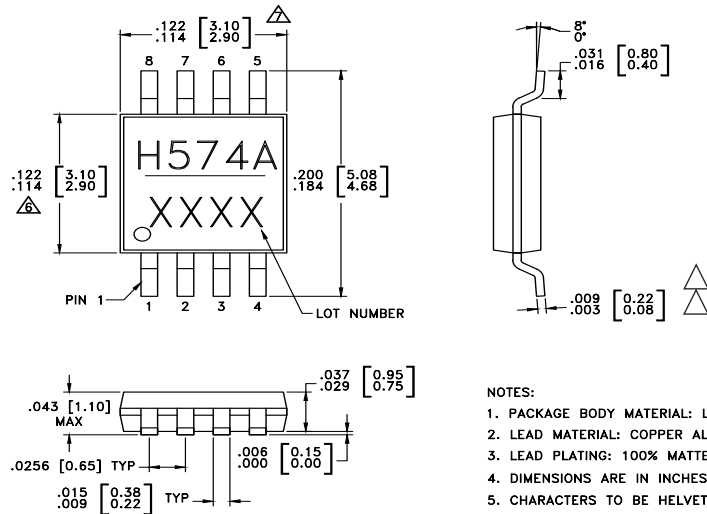

**NOTES:**

1. PACKAGE BODY MATERIAL: LOW STRESS INJECTION MOLDED PLASTIC SILICA AND SILICON IMPREGNATED.
2. LEAD MATERIAL: COPPER ALLOY.
3. LEAD PLATING: 100% MATTE TIN.
4. DIMENSIONS ARE IN INCHES [MILLIMETERS].
5. CHARACTERS TO BE HELVETICA MEDIUM, .030 HIGH, LASER OR WHITE INK, LOCATED APPROXIMATELY AS SHOWN.
6. DIMENSION DOES NOT INCLUDE MOLDFLASH OF 0.15mm PER SIDE.
7. DIMENSION DOES NOT INCLUDE MOLDFLASH OF 0.25mm PER SIDE.
8. ALL GROUND LEADS AND GROUND PADDLE MUST BE SOLDERED TO PCB RF GROUND

### Package Information

Part Number	Package Body Material	Lead Finish	MSL Rating	Package Marking <sup>[2]</sup>
HMC574AMS8E	RoHS-compliant Low Stress Injection Molded Plastic	100% matte Sn	MSL1 <sup>[1]</sup>	H574A XXXX

[1] Max peak reflow temperature of 260 °C

[2] 4-Digit lot number XXXX

### Pin Descriptions

Pin Number	Function	Description	Interface Schematic
1	A	See truth table and control voltage table.	
2	B	See truth table and control voltage table.	
3, 5, 8	RFC, RF1, RF2	This pin is DC coupled and matched to 50 Ohm. Blocking capacitors are required.	
4	Vdd	Supply Voltage.	
6, 7	GND	This pin must be connected to RF/DC ground.	

**GaAs MMIC 5 WATT T/R SWITCH  
DC - 3 GHz**

**Typical Application Circuit**

Notes:

1. Set logic gate and switch Vdd = +3V to +5V and use HCT series logic to provide a TTL driver interface.
2. Control inputs A/B can be driven directly with CMOS logic (HC) with Vdd of +3 to +8 Volts applied to the CMOS logic gates and to pin 4 of the RF switch.
3. DC Blocking capacitors are required for each RF port as shown. Capacitor value determines lowest frequency of operation.
4. Highest RF signal power capability is achieved with Vdd set to +8V. The switch will operate properly (but at lower RF power capability) at bias voltages down to +3V.

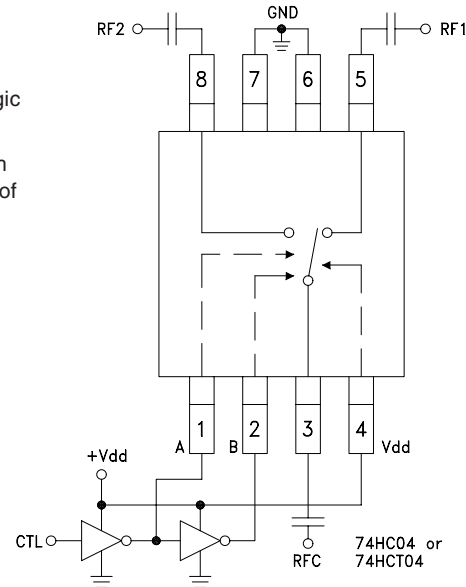

**Evaluation Circuit Board**

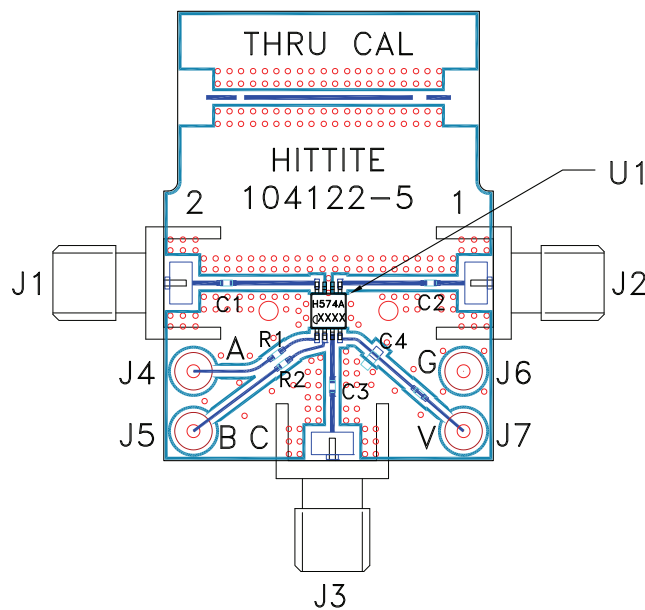

**List of Materials for  
Evaluation PCB**

**EV1HMC574AMS8 [1]**

Item	Description
J1 - J3	PCB Mount SMA RF Connector
J4 - J7	DC Pin
C1 - C3	100 pF capacitor, 0402 Pkg.
C4	10,000 pF capacitor, 0603 Pkg.
R1, R2	100 Ohm resistor, 0402 Pkg.
U1	HMC574AMS8E T/R Switch
PCB [2]	104122 Evaluation PCB

[1] Reference this number when ordering complete evaluation PCB

[2] Circuit Board Material: Rogers 4350

The circuit board used in the application should be generated with proper RF circuit design techniques. Signal lines at the RF port should have 50 Ohm impedance and the package ground leads and package bottom should be connected directly to the ground plane similar to that shown above. The evaluation circuit board shown above is available from Analog Devices Inc upon request.



Компания «ЭлектроПласт» предлагает заключение долгосрочных отношений при поставках импортных электронных компонентов на взаимовыгодных условиях!

Наши преимущества:

- Оперативные поставки широкого спектра электронных компонентов отечественного и импортного производства напрямую от производителей и с крупнейших мировых складов;
- Поставка более 17-ти миллионов наименований электронных компонентов;
- Поставка сложных, дефицитных, либо снятых с производства позиций;
- Оперативные сроки поставки под заказ (от 5 рабочих дней);
- Экспресс доставка в любую точку России;
- Техническая поддержка проекта, помощь в подборе аналогов, поставка прототипов;
- Система менеджмента качества сертифицирована по Международному стандарту ISO 9001;
- Лицензия ФСБ на осуществление работ с использованием сведений, составляющих государственную тайну;
- Поставка специализированных компонентов (Xilinx, Altera, Analog Devices, Intersil, Interpoint, Microsemi, Aeroflex, Peregrine, Syfer, Eurofarad, Texas Instrument, Miteq, Cobham, E2V, MA-COM, Hittite, Mini-Circuits, General Dynamics и др.);

Помимо этого, одним из направлений компании «ЭлектроПласт» является направление «Источники питания». Мы предлагаем Вам помощь Конструкторского отдела:

- Подбор оптимального решения, техническое обоснование при выборе компонента;
- Подбор аналогов;
- Консультации по применению компонента;
- Поставка образцов и прототипов;
- Техническая поддержка проекта;
- Защита от снятия компонента с производства.



#### Как с нами связаться

**Телефон:** 8 (812) 309 58 32 (многоканальный)

**Факс:** 8 (812) 320-02-42

**Электронная почта:** [org@eplast1.ru](mailto:org@eplast1.ru)

**Адрес:** 198099, г. Санкт-Петербург, ул. Калинина, дом 2, корпус 4, литера А.