

Optocoupler, Phototransistor Output, AC Input

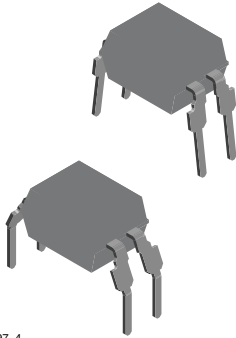

17197_4

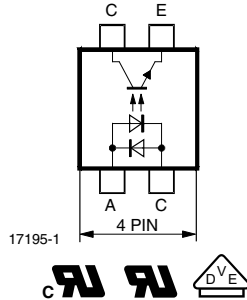

DESCRIPTION

The TCET1600, TCET1600G consists of a phototransistor optically coupled to 2 gallium arsenide infrared-emitting diodes in a single (4 pin) package.

VDE STANDARDS

These couplers perform safety functions according to the following equipment standards:

- **DIN EN 60747-5-2 (VDE 0884)**
Optocoupler for electrical safety requirements
- **IEC 60950/EN 60950**
Office machines (applied for reinforced isolation for mains voltage $\leq 400 V_{RMS}$)
- **VDE 0804**
Telecommunication apparatus and data processing
- **IEC 60065**
Safety for mains-operated electronic and related household apparatus
- **VDE 0700/IEC 335**
Household equipment
- **VDE 0160**
Electronic equipment for electrical power installation
- **VDE 0750/IEC 60601**
Medical equipment

FEATURES

- Isolation materials according to UL94 V-O
- Pollution degree 2 (DIN/VDE 0110 /resp. IEC 60664)
- Climatic classification 55/100/21 (IEC 60068 part 1)
- Special construction: therefore, extra low coupling capacity of typical 0.2 pF, high common mode rejection
- Low temperature coefficient of CTR
- Rated impulse voltage (transient overvoltage) $V_{IOTM} = 10 \text{ kV peak}$
- Isolation test voltage (partial discharge test voltage) $V_{pd} = 1.6 \text{ kV peak}$
- Rated isolation voltage (RMS includes DC) $V_{IOWM} = 600 V_{RMS}$
- Rated recurring peak voltage (repetitive) $V_{IORM} = 890 V_{peak}$
- Thickness though insulation $\geq 0.75 \text{ mm}$
- Creepage current resistance according to VDE 0303/ IEC 60112 comparative tracking index: $CTI \geq 175$
- Compliant to RoHS Directive 2002/95/EC and in accordance to WEEE 2002/96/EC



RoHS
COMPLIANT

AGENCY APPROVALS

- UL1577, file no. E52744 system code H, double protection
- CSA 22.2 bulletin 5A
- DIN EN 60747-5-2 (VDE 0884)
- DIN EN 60747-5-5 (pending)
- FIMKO

ORDERING INFORMATION

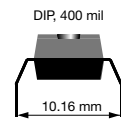
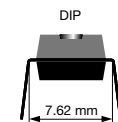
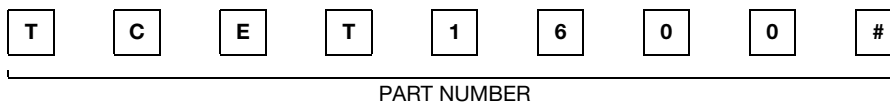

AGENCY CERTIFIED/PACKAGE	CTR (%)
	± 5 mA
UL, cUL, VDE, FIMKO	20 to 300
DIP-4, single channel	TCET1600
DIP-4, single channel, 400 mil	TCET1600G

Note

- G = leadform 10.16 mm; G is not marked on the body.

ABSOLUTE MAXIMUM RATINGS ⁽¹⁾ ($T_{amb} = 25\text{ }^{\circ}\text{C}$, unless otherwise specified)				
PARAMETER	TEST CONDITION	SYMBOL	VALUE	UNIT
INPUT				
Reverse voltage		V_R	6	V
Forward current		I_F	± 60	mA
Forward surge current	$t_p \leq 10\text{ }\mu\text{s}$	I_{FSM}	± 1.5	A
Power dissipation		P_{diss}	100	mW
Junction temperature		T_j	125	$^{\circ}\text{C}$
OUTPUT				
Collector emitter voltage		V_{CEO}	70	V
Emitter collector voltage		V_{ECO}	7	V
Collector current		I_C	50	mA
Collector peak current	$t_p/T = 0.5, t_p \leq 10\text{ ms}$	I_{CM}	100	mA
Power dissipation		P_{diss}	150	mW
Junction temperature		T_j	125	$^{\circ}\text{C}$
COUPLER				
Isolation test voltage (RMS)	$t = 1\text{ s}$	V_{ISO}	5300	V_{RMS}
Isolation voltage		V_{IORM}	890	V_P
Total power dissipation		P_{tot}	250	mW
Operating ambient temperature range		T_{amb}	- 55 to + 100	$^{\circ}\text{C}$
Storage temperature range		T_{stg}	- 55 to + 150	$^{\circ}\text{C}$
Soldering temperature ⁽²⁾	2 mm from case, $t \leq 10\text{ s}$	T_{sld}	260	$^{\circ}\text{C}$

Notes

- ⁽¹⁾ Stresses in excess of the absolute maximum ratings can cause permanent damage to the device. Functional operation of the device is not implied at these or any other conditions in excess of those given in the operational sections of this document. Exposure to absolute maximum ratings for extended periods of the time can adversely affect reliability.
- ⁽²⁾ Refer to wave profile for soldering conditions for through hole devices (DIP).

ELECTRICAL CHARACTERISTICS ($T_{amb} = 25\text{ }^{\circ}\text{C}$, unless otherwise specified)						
PARAMETER	TEST CONDITION	SYMBOL	MIN.	TYP.	MAX.	UNIT
INPUT						
Forward voltage	$I_F = \pm 50\text{ mA}$	V_F		1.25	1.6	V
Junction capacitance	$V_R = 0\text{ V}, f = 1\text{ MHz}$	C_j		50		pF
OUTPUT						
Collector emitter voltage	$I_C = 100\text{ }\mu\text{A}$	V_{CEO}	70			V
Emitter collector voltage	$I_E = 100\text{ }\mu\text{A}$	V_{ECO}	7			V
Collector dark current	$V_{CE} = 20\text{ V}, I_F = 0, E = 0$	I_{CEO}			100	nA
COUPLER						
Collector emitter saturation voltage	$I_F = 10\text{ mA}, I_C = 1\text{ mA}$	V_{CEsat}			0.3	V
Cut-off frequency	$V_{CE} = 5\text{ V}, I_F = 10\text{ mA}, R_L = 100\text{ }\Omega$	f_c		100		kHz
Coupling capacitance	$f = 1\text{ MHz}$	C_k		0.3		pF

Note

- Minimum and maximum values were tested requirements. Typical values are characteristics of the device and are the result of engineering evaluations. Typical values are for information only and are not part of the testing requirements.



CURRENT TRANSFER RATIO						
PARAMETER	TEST CONDITION	SYMBOL	MIN.	TYP.	MAX.	UNIT
I_C/I_F	$V_{CE} = 5\text{ V}$, $I_F = \pm 5\text{ mA}$	CTR	20		300	%

MAXIMUM SAFETY RATINGS						
PARAMETER	TEST CONDITION	SYMBOL	MIN.	TYP.	MAX.	UNIT
INPUT						
Forward current		I_F			275	mA
OUTPUT						
Power dissipation		P_{diss}			400	mW
COUPLER						
Rated impulse voltage		V_{IOTM}			10	kV
Safety temperature		T_{si}			175	°C

Note

- According to DIN EN 60747-5-2 (VDE 0884) (see figure 1). This optocoupler is suitable for safe electrical isolation only within the safety ratings. Compliance with the safety ratings shall be ensured by means of suitable protective circuits.

INSULATION RATED PARAMETERS						
PARAMETER	TEST CONDITION	SYMBOL	MIN.	TYP.	MAX.	UNIT
Partial discharge test voltage - routine test	100 %, $t_{test} = 1\text{ s}$	V_{pd}	1.669			kV
Partial discharge test voltage - lot test (sample test)	$t_{Tr} = 60\text{ s}$, $t_{test} = 10\text{ s}$, (see figure 2)	V_{IOTM}	10			kV
		V_{pd}	1.424			kV
Insulation resistance	$V_{IO} = 500\text{ V}$	R_{IO}	10^{12}			Ω
	$V_{IO} = 500\text{ V}$, $T_{amb} = 100\text{ °C}$	R_{IO}	10^{11}			Ω
	$V_{IO} = 500\text{ V}$, $T_{amb} = 150\text{ °C}$ (construction test only)	R_{IO}	10^9			Ω

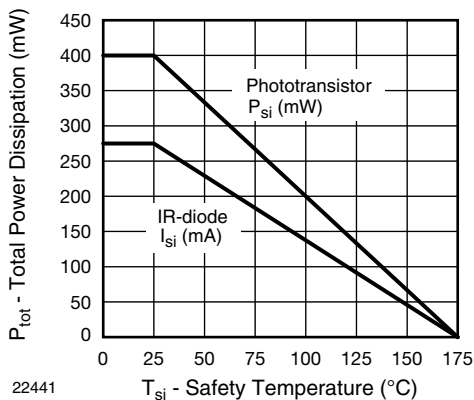

Fig. 1 - Derating Diagram

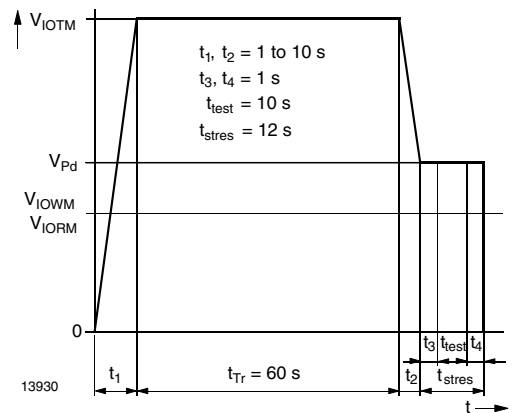

Fig. 2 - Test Pulse Diagram for Sample Test acc. to DIN EN 60747-5-2 (VDE 0884); IEC60747-5-5

SWITCHING CHARACTERISTICS						
PARAMETER	TEST CONDITION	SYMBOL	MIN.	TYP.	MAX.	UNIT
Delay time	$V_S = 5\text{ V}$, $I_C = 2\text{ mA}$, $R_L = 100\ \Omega$, (see figure 3)	t_d		3		μs
Rise time	$V_S = 5\text{ V}$, $I_C = 2\text{ mA}$, $R_L = 100\ \Omega$, (see figure 3)	t_r		3		μs
Turn-on time	$V_S = 5\text{ V}$, $I_C = 2\text{ mA}$, $R_L = 100\ \Omega$, (see figure 3)	t_{on}		6		μs
Storage time	$V_S = 5\text{ V}$, $I_C = 2\text{ mA}$, $R_L = 100\ \Omega$, (see figure 3)	t_s		0.3		μs
Fall time	$V_S = 5\text{ V}$, $I_C = 2\text{ mA}$, $R_L = 100\ \Omega$, (see figure 3)	t_f		4.7		μs
Turn-off time	$V_S = 5\text{ V}$, $I_C = 2\text{ mA}$, $R_L = 100\ \Omega$, (see figure 3)	t_{off}		5		μs
Turn-on time	$V_S = 5\text{ V}$, $I_F = 10\text{ mA}$, $R_L = 1\text{ k}\Omega$, (see figure 4)	t_{on}		9		μs
Turn-off time	$V_S = 5\text{ V}$, $I_F = 10\text{ mA}$, $R_L = 1\text{ k}\Omega$, (see figure 4)	t_{off}		10		μs

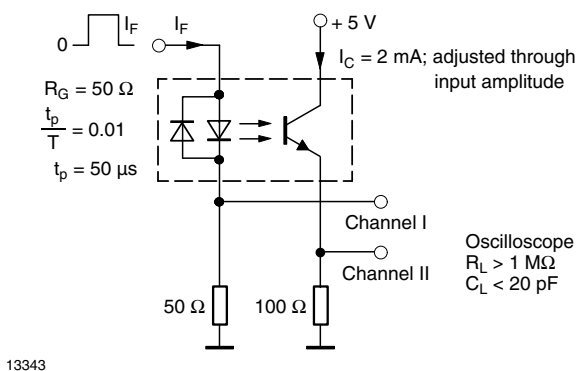

Fig. 3 - Test Circuit, Non-Saturated Operation

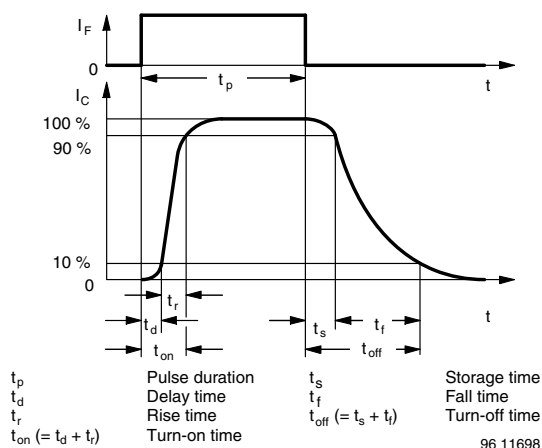

Fig. 5 - Switching Times

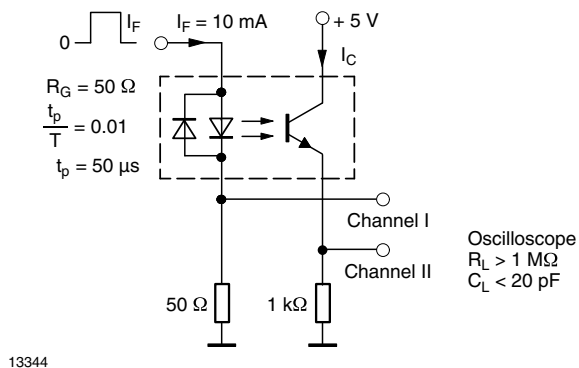

Fig. 4 - Test Circuit, Saturated Operation

TYPICAL CHARACTERISTICS ($T_{amb} = 25\text{ }^{\circ}\text{C}$, unless otherwise specified)

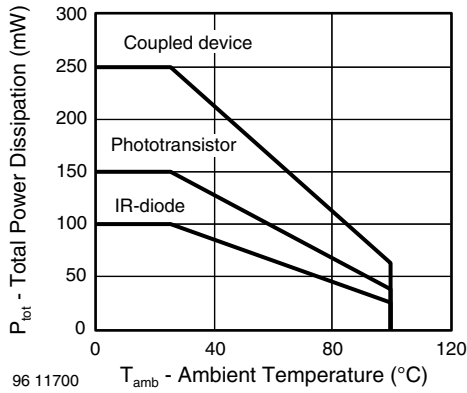

Fig. 6 - Total Power Dissipation vs. Ambient Temperature

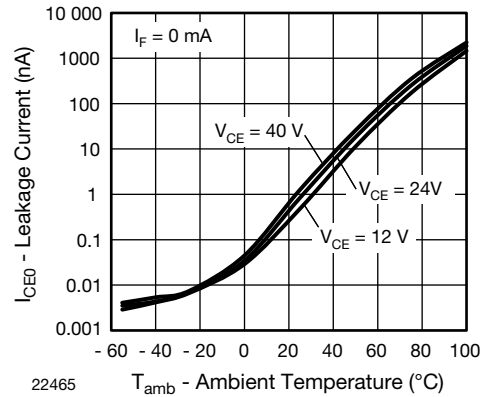

Fig. 9 - Leakage Current vs. Ambient Temperature

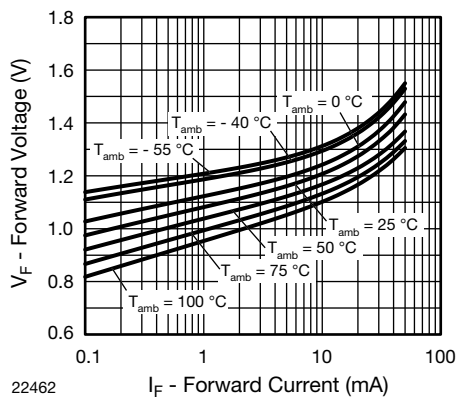

Fig. 7 - Forward Current vs. Forward Voltage

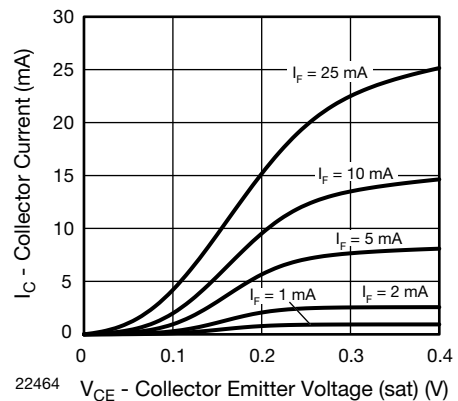

Fig. 10 - Collector Current vs. Collector Emitter Voltage (sat)

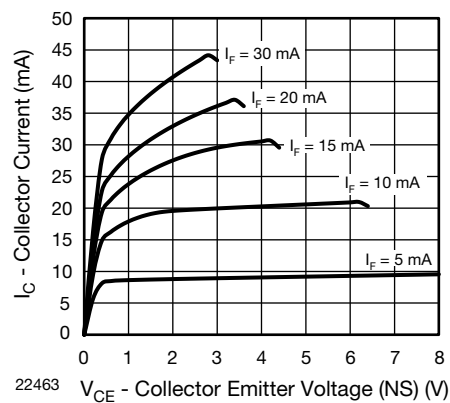

Fig. 8 - Collector Current vs. Collector Emitter Voltage (NS)

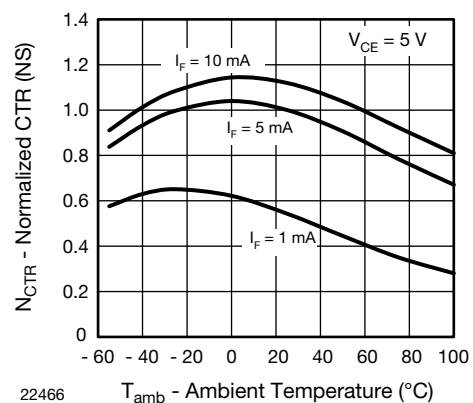

Fig. 11 - Normalized CTR (NS) vs. Ambient Temperature

TCET1600, TCET1600G



Vishay Semiconductors Optocoupler, Phototransistor Output,
AC Input

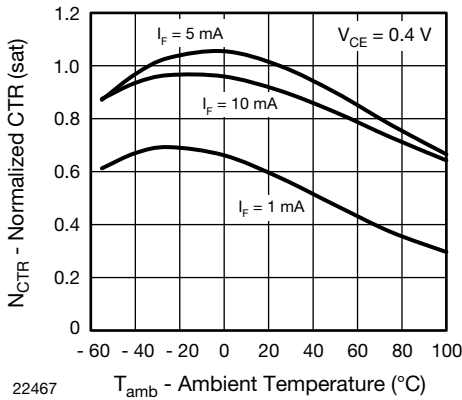

Fig. 12 - Normalized CTR (sat) vs. Ambient Temperature

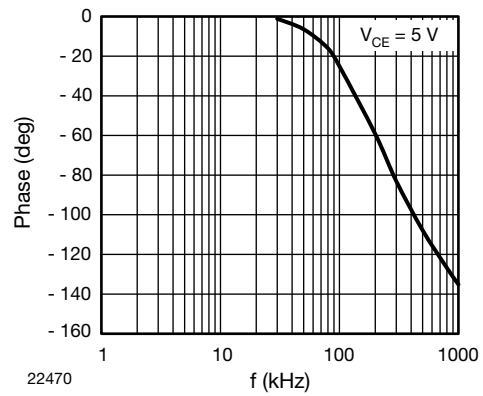

Fig. 15 - F_{CTR} vs. Phase Angle

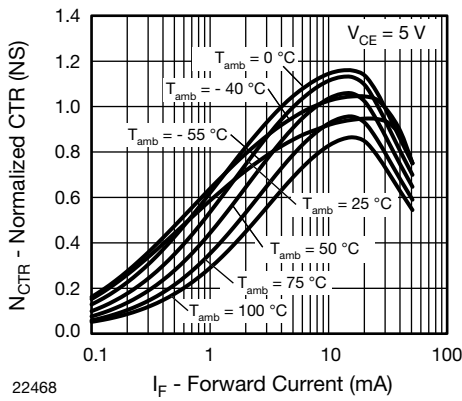

Fig. 13 - Normalized CTR (NS) vs. Forward Current

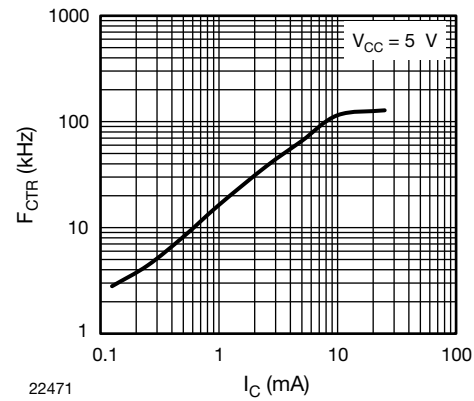

Fig. 16 - F_{CTR} vs. I_C

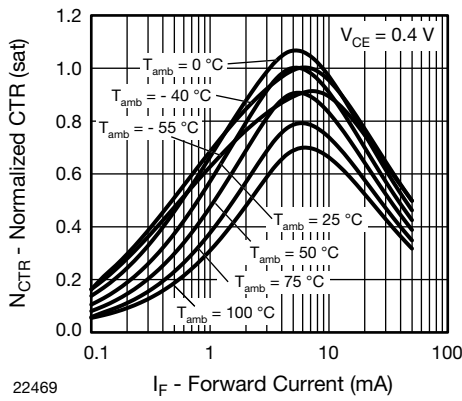

Fig. 14 - Normalized CTR (sat) vs. Forward Current

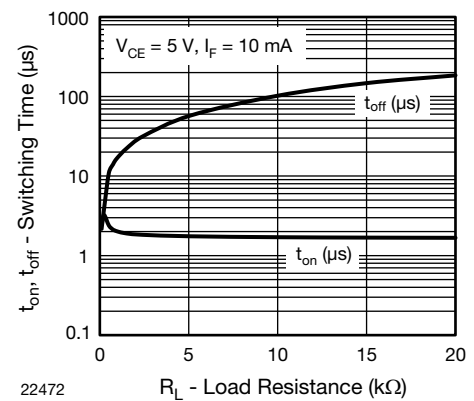

Fig. 17 - Switching Time vs. Load Resistance



TCET1600, TCET1600G

Optocoupler, Phototransistor Output, Vishay Semiconductors
AC Input

PACKAGE DIMENSIONS in millimeters

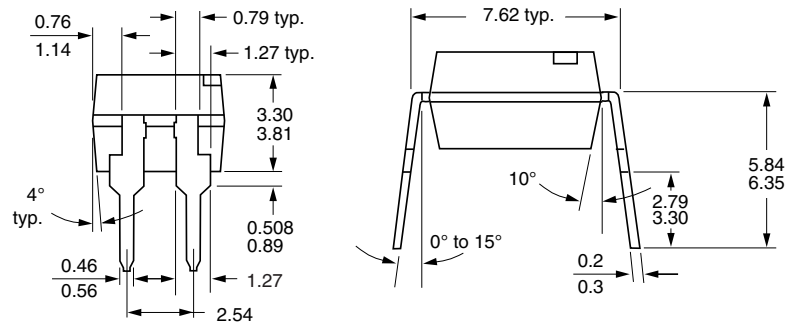
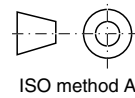
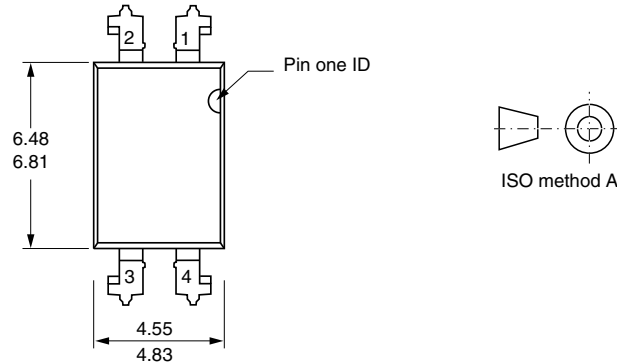

i178027

Option 6

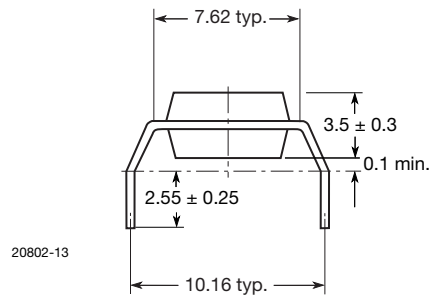

20802-13

PACKAGE MARKING (example)

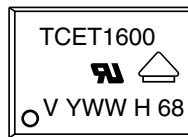

21764-93



Disclaimer

ALL PRODUCT, PRODUCT SPECIFICATIONS AND DATA ARE SUBJECT TO CHANGE WITHOUT NOTICE TO IMPROVE RELIABILITY, FUNCTION OR DESIGN OR OTHERWISE.

Vishay Intertechnology, Inc., its affiliates, agents, and employees, and all persons acting on its or their behalf (collectively, "Vishay"), disclaim any and all liability for any errors, inaccuracies or incompleteness contained in any datasheet or in any other disclosure relating to any product.

Vishay makes no warranty, representation or guarantee regarding the suitability of the products for any particular purpose or the continuing production of any product. To the maximum extent permitted by applicable law, Vishay disclaims (i) any and all liability arising out of the application or use of any product, (ii) any and all liability, including without limitation special, consequential or incidental damages, and (iii) any and all implied warranties, including warranties of fitness for particular purpose, non-infringement and merchantability.

Statements regarding the suitability of products for certain types of applications are based on Vishay's knowledge of typical requirements that are often placed on Vishay products in generic applications. Such statements are not binding statements about the suitability of products for a particular application. It is the customer's responsibility to validate that a particular product with the properties described in the product specification is suitable for use in a particular application. Parameters provided in datasheets and/or specifications may vary in different applications and performance may vary over time. All operating parameters, including typical parameters, must be validated for each customer application by the customer's technical experts. Product specifications do not expand or otherwise modify Vishay's terms and conditions of purchase, including but not limited to the warranty expressed therein.

Except as expressly indicated in writing, Vishay products are not designed for use in medical, life-saving, or life-sustaining applications or for any other application in which the failure of the Vishay product could result in personal injury or death. Customers using or selling Vishay products not expressly indicated for use in such applications do so at their own risk. Please contact authorized Vishay personnel to obtain written terms and conditions regarding products designed for such applications.

No license, express or implied, by estoppel or otherwise, to any intellectual property rights is granted by this document or by any conduct of Vishay. Product names and markings noted herein may be trademarks of their respective owners.

Material Category Policy

Vishay Intertechnology, Inc. hereby certifies that all its products that are identified as RoHS-Compliant fulfill the definitions and restrictions defined under Directive 2011/65/EU of The European Parliament and of the Council of June 8, 2011 on the restriction of the use of certain hazardous substances in electrical and electronic equipment (EEE) - recast, unless otherwise specified as non-compliant.

Please note that some Vishay documentation may still make reference to RoHS Directive 2002/95/EC. We confirm that all the products identified as being compliant to Directive 2002/95/EC conform to Directive 2011/65/EU.

Vishay Intertechnology, Inc. hereby certifies that all its products that are identified as Halogen-Free follow Halogen-Free requirements as per JEDEC JS709A standards. Please note that some Vishay documentation may still make reference to the IEC 61249-2-21 definition. We confirm that all the products identified as being compliant to IEC 61249-2-21 conform to JEDEC JS709A standards.



Компания «ЭлектроПласт» предлагает заключение долгосрочных отношений при поставках импортных электронных компонентов на взаимовыгодных условиях!

Наши преимущества:

- Оперативные поставки широкого спектра электронных компонентов отечественного и импортного производства напрямую от производителей и с крупнейших мировых складов;
- Поставка более 17-ти миллионов наименований электронных компонентов;
- Поставка сложных, дефицитных, либо снятых с производства позиций;
- Оперативные сроки поставки под заказ (от 5 рабочих дней);
- Экспресс доставка в любую точку России;
- Техническая поддержка проекта, помощь в подборе аналогов, поставка прототипов;
- Система менеджмента качества сертифицирована по Международному стандарту ISO 9001;
- Лицензия ФСБ на осуществление работ с использованием сведений, составляющих государственную тайну;
- Поставка специализированных компонентов (Xilinx, Altera, Analog Devices, Intersil, Interpoint, Microsemi, Aeroflex, Peregrine, Syfer, Eurofarad, Texas Instrument, Miteq, Cobham, E2V, MA-COM, Hittite, Mini-Circuits, General Dynamics и др.);

Помимо этого, одним из направлений компании «ЭлектроПласт» является направление «Источники питания». Мы предлагаем Вам помощь Конструкторского отдела:

- Подбор оптимального решения, техническое обоснование при выборе компонента;
- Подбор аналогов;
- Консультации по применению компонента;
- Поставка образцов и прототипов;
- Техническая поддержка проекта;
- Защита от снятия компонента с производства.



Как с нами связаться

Телефон: 8 (812) 309 58 32 (многоканальный)

Факс: 8 (812) 320-02-42

Электронная почта: org@eplast1.ru

Адрес: 198099, г. Санкт-Петербург, ул. Калинина, дом 2, корпус 4, литера А.