

15.5kV E-Rated

Medium voltage fuses for feeder circuit, switchgear and transformer protection



Description:

- The Bussmann® series of E-Rated, current-limiting, medium voltage fuses are for feeder circuit, switchgear and transformer protection.

Features and benefits:

- Current-limiting E-Rated medium voltage fuses are defined by their melting time-current characteristic that permit their electrical interchangeability with other fuses of the same E Rating.
- E-Rated fuses must have a defined current response time specified by ANSI C37.46. E-Rated fuse of 100 amps and below must melt in 300 seconds at an RMS current within the range of 200% to 240% of the fuse's nameplate current rating. E-Rated fuses greater than 100 amps must melt in 600 seconds at an RMS current within the range of 220% to 264% of the fuse's nameplate current rating.
- E-Rated fuses are physically dimensioned for easy installation in existing hardware.
- Current-limiting fuses provide positive interruption even on low fault currents. The fuse limits the magnitude of electromechanical stresses in the protected apparatus.
- Constructions available in ferrule, bolt-on and clip-lock, and specialty mount fuses for AMPGARD™ motor starters
- Outdoor rating available on select catalog numbers (requires installation in a suitable enclosure).
- Open fuse indicator easily integrates into automation schemes and speeds troubleshooting by providing a positive visual indication of fuse operation.
- 50/60Hz operating frequency for worldwide application.
- Mountings are available in disconnect and non-disconnect versions with porcelain or glass polyester insulators.
- Live parts and end fittings available.

Typical applications:

- Medium voltage transformer primary protection
- Medium voltage feeder circuit protection
- Medium voltage switches
- Medium voltage metal-enclosed switchgear



Powering Business Worldwide

E-Rated medium voltage ferrule fuses

Catalog symbols:

- General purpose
 - 15CLE-_E-D (long construction, 10-25A)
 - 15CLE-_E (long construction, 15-300A)
 - 15HLE-_E (short construction, 10-250A)
 - 15LHLE-_E (intermediate construction, 65-300A)
- Full range (per ANSI C37.40)
 - MV155F_

Ratings*:

- Volts — 15.5kV
 - Amps — 10 to 300A
 - Interrupting ratings — 31.5 to 63kA RMS Sym.
- * See catalog number tables for voltages, ampacities and interrupting ratings by catalog number.

Agency information:

- E-Rated fuses meet the performance characteristics of ANSI C37.46
- UL® Listed, Guide JEEG, File E240398. See catalog numbers.

Dimensions (see catalog number tables for values)



Recommended fuseclips and holders:

		Catalog number							
		Approximate dimensions - in (mm)				Mounting (including live parts, end fittings)**			
Amp rating	Fuse mounting type*	Voltage BIL (kV)	Diameter	Clip center	Length	Porcelain insulator	Glass-polyester insulator	Live parts (including end fittings)	End fittings (disconnect only)
CLE			A	B	C				
15E-25E Single barrel	Non-disconnect	95	2 (51)	20 (508)	21.5 (546)	15CLE-PNM-C	15CLE-GNM-C	CLE-NL-C	—
		110				15CLE-HPNM-C	—	CLE-NL-C	—
	Disconnect†	95				15CLE-PDM-C	15CLE-GDM-C	CLE-DL-C	CLE-DF-C
		110				15CLE-HPDM-C	—	CLE-DL-C	CLE-DF-C
10E-D-25E-D 30E-150E Single barrel	Non-disconnect	95	3 (76)	20 (508)	23.9 (607)	15CLE-PNM-D	15CLE-GNM-D	CLE-NL-D	—
		110				15CLE-HPM-D	—	CLE-NL-D	—
	Disconnect†	95				15CLE-PDM-D	15CLE-GNM-D	CLE-DL-D	CLE-DF-D
		110				15CLE-HPDM-D	—	CLE-DL-D	CLE-DF-D
175E-300E Double barrel	Non-disconnect	110	3 (76)	20 (508)	23.9 (607)	15CLE-PNM-E	—	CLE-NL-E	—
	Disconnect†	110				15CLE-PDM-E	—	CLE-DL-E	CLE-DF-E
HLE									
10E-125E Single barrel	Non-disconnect	95	3 (76)	15 (381)	18.9 (480)	15HLE-PNM-D	15HLE-GNM-D	CLE-NL-D	—
	Disconnect†	95				15HLE-PDM-D	15HLE-GDM-D	CLE-DL-D	CLE-DF-D
150E-250E Double barrel	Non-disconnect	95	3 (76)	15 (381)	18.9 (480)	15HLE-PNM-E	—	CLE-NL-E	—
	Disconnect†	95				15HLE-PDM-E	—	CLE-DL-E	CLE-DF-E
LHLE									
65E-150E Single barrel	Non-disconnect	—	3 (76)	18 (457)	20.53 (521)	Not available	Not available	CLE-NL-D	—
	Disconnect†	—				Not available	Not available	CLE-DL-D	CLE-DF-D
175E-300E Double barrel	Non-disconnect	—	3 (76)	18 (457)	20.53 (521)	Not available	Not available	CLE-NL-E	—
	Disconnect†	—				Not available	Not available	CLE-DL-E	CLE-DF-E

* See page 10 for illustrations and dimensions

** End fittings supplied only when required.

† Disconnect mountings provide a means for fuse extraction only. Do not use a disconnect mounting for load switching or fuse removal while energized.

CLE, HLE and LHLE type general purpose fuses

Amp rating	Dimensions - in (mm)			Interrupting rating kA (RMS Sym.)	Number of barrels	Installation location	Catalog number
	Length A	Diameter B	Clip centers C				
CLE Long construction							
10	23.9 (607)	3 (76)	20 (508)	63	1	Indoor/outdoor	15CLE-10E-D
15	21.5 (546)	2 (51)	20 (508)	31.5	1	Indoor	15CLE-15E*
15	23.9 (607)	3 (76)	20 (508)	63	1	Indoor/outdoor	15CLE-15E-D
20	21.5 (546)	2 (51)	20 (508)	31.5	1	Indoor	15CLE-20E*
20	23.9 (607)	3 (76)	20 (508)	63	1	Indoor/outdoor	15CLE-20E-D
25	21.5 (546)	2 (51)	20 (508)	31.5	1	Indoor	15CLE-25E*
25	23.9 (607)	3 (76)	20 (508)	63	1	Indoor/outdoor	15CLE-25E-D
30	23.9 (607)	3 (76)	20 (508)	63	1	Indoor/outdoor	15CLE-30E
40	23.9 (607)	3 (76)	20 (508)	63	1	Indoor/outdoor	15CLE-40E†
50	23.9 (607)	3 (76)	20 (508)	63	1	Indoor/outdoor	15CLE-50E†
65	23.9 (607)	3 (76)	20 (508)	63	1	Indoor/outdoor	15CLE-65E†
80	23.9 (607)	3 (76)	20 (508)	63	1	Indoor/outdoor	15CLE-80E†
100	23.9 (607)	3 (76)	20 (508)	63	1	Indoor/outdoor	15CLE-100E†
125	23.9 (607)	3 (76)	20 (508)	63	1	Indoor/outdoor	15CLE-125E†
150	23.9 (607)	3 (76)	20 (508)	63	1	Indoor/outdoor	15CLE-150E†
175	23.9 (607)	3 (76)	20 (508)	63	2	Indoor/outdoor	15CLE-175E†
200	23.9 (607)	3 (76)	20 (508)	63	2	Indoor/outdoor	15CLE-200E†
250	23.9 (607)	3 (76)	20 (508)	63	2	Indoor/outdoor	15CLE-250E†
300	23.9 (607)	3 (76)	20 (508)	63	2	Indoor/outdoor	15CLE-300E†
HLE Short construction							
10	18.9 (480)	3 (76)	15 (381)	63	1	Indoor/outdoor	15HLE-10E
15	18.9 (480)	3 (76)	15 (381)	63	1	Indoor/outdoor	15HLE-15E
20	18.9 (480)	3 (76)	15 (381)	63	1	Indoor/outdoor	15HLE-20E
25	18.9 (480)	3 (76)	15 (381)	63	1	Indoor/outdoor	15HLE-25E
30	18.9 (480)	3 (76)	15 (381)	63	1	Indoor/outdoor	15HLE-30E
40	18.9 (480)	3 (76)	15 (381)	63	1	Indoor/outdoor	15HLE-40E†
50	18.9 (480)	3 (76)	15 (381)	63	1	Indoor/outdoor	15HLE-50E†
65	18.9 (480)	3 (76)	15 (381)	63	1	Indoor/outdoor	15HLE-65E†
80	18.9 (480)	3 (76)	15 (381)	63	1	Indoor/outdoor	15HLE-80E†
100	18.9 (480)	3 (76)	15 (381)	63	1	Indoor/outdoor	15HLE-100E†
125	18.9 (480)	3 (76)	15 (381)	63	1	Indoor/outdoor	15HLE-125E†
150	18.9 (480)	3 (76)	15 (381)	63	2	Indoor/outdoor	15HLE-150E†
175	18.9 (480)	3 (76)	15 (381)	63	2	Indoor/outdoor	15HLE-175E†
200	18.9 (480)	3 (76)	15 (381)	63	2	Indoor/outdoor	15HLE-200E†
250	18.9 (480)	3 (76)	15 (381)	63	2	Indoor/outdoor	15HLE-250E†
LHLE							
65	20.5 (521)	3 (76)	18 (457)	50	1	Indoor/outdoor	15LHLE-65E
80	20.5 (521)	3 (76)	18 (457)	50	1	Indoor/outdoor	15LHLE-80E
100	20.5 (521)	3 (76)	18 (457)	50	1	Indoor/outdoor	15LHLE-100E
125	20.5 (521)	3 (76)	18 (457)	50	1	Indoor/outdoor	15LHLE-125E
150	20.5 (521)	3 (76)	18 (457)	50	1	Indoor/outdoor	15LHLE-150E
175	20.5 (521)	3 (76)	18 (457)	50	2	Indoor/outdoor	15LHLE-175E
200	20.5 (521)	3 (76)	18 (457)	50	2	Indoor/outdoor	15LHLE-200E
250	20.5 (521)	3 (76)	18 (457)	50	2	Indoor/outdoor	15LHLE-250E
300	20.5 (521)	3 (76)	18 (457)	50	2	Indoor/outdoor	15LHLE-300E

* Fuses conform to dimensional standards established by Westinghouse.

† UL Listed, Guide JEEG, File E240398.

MV155F_ full range

Amp rating	Dimensions - in (mm)			Interrupting rating kA (RMS Sym.)	Number of barrels	Installation location	Catalog number
	Length A	Diameter B	Clip centers C				
5	18.7 (475)	2 (51)	15 (381)	50	1	Indoor	MV155F1CBX5E
7	18.7 (475)	2 (51)	15 (381)	50	1	Indoor	MV155F1CBX7E
10	18.7 (475)	2 (51)	15 (381)	50	1	Indoor	MV155F1CBX10E
10	18.7 (475)	3 (76)	15 (381)	50	1	Indoor	MV155F1DBX10E
15	18.7 (475)	2 (51)	15 (381)	50	1	Indoor	MV155F1CBX15E
15	18.7 (475)	3 (76)	15 (381)	50	1	Indoor	MV155F1DBX15E
20	18.7 (475)	2 (51)	15 (381)	50	1	Indoor	MV155F1CBX20E
20	18.7 (475)	3 (76)	15 (381)	50	1	Indoor	MV155F1DBX20E
25	18.7 (475)	2 (51)	15 (381)	50	1	Indoor	MV155F1CBX25E
25	18.7 (475)	3 (76)	15 (381)	50	1	Indoor	MV155F1DBX25E
30	18.7 (475)	2 (51)	15 (381)	50	1	Indoor	MV155F1CBX30E
30	18.7 (475)	3 (76)	15 (381)	50	1	Indoor	MV155F1DBX30E
40	18.7 (475)	3 (76)	15 (381)	50	1	Indoor	MV155F1DBX40E
50	18.7 (475)	3 (76)	15 (381)	50	1	Indoor	MV155F1DBX50E
65	18.7 (475)	3 (76)	15 (381)	50	1	Indoor	MV155F1DBX65E
65	21.7 (551)	3 (76)	18 (457)	50	1	Indoor	MV155F1DCX65E
80	18.7 (475)	3 (76)	15 (381)	50	1	Indoor	MV155F1DBX80E
80	21.7 (551)	3 (76)	18 (457)	50	1	Indoor	MV155F1DCX80E
100	18.7 (475)	3 (76)	15 (381)	50	1	Indoor	MV155F1DBX100E
100	21.7 (551)	3 (76)	18 (457)	50	1	Indoor	MV155F1DCX100E
125	18.7 (475)	3 (76)	15 (381)	50	2	Indoor	MV155F2DBX125E
125	21.7 (551)	3 (76)	18 (457)	50	2	Indoor	MV155F2DCX125E
150	18.7 (475)	3 (76)	15 (381)	50	2	Indoor	MV155F2DBX150E
150	21.7 (551)	3 (76)	18 (457)	50	2	Indoor	MV155F2DCX150E
175	18.7 (475)	3 (76)	15 (381)	50	2	Indoor	MV155F2DBX175E
175	21.7 (551)	3 (76)	18 (457)	50	2	Indoor	MV155F2DCX175E
200	18.7 (475)	3 (76)	15 (381)	50	2	Indoor	MV155F2DBX200E
200	21.7 (551)	3 (76)	18 (457)	50	2	Indoor	MV155F2DCX200E

Recommended MV155 fuseclips:

Description	Fuse diameter - in (mm)	Figure	Clip dimensions - in (mm)							Catalog number
			A	B	C	D	E	F	G	
Enclosed fuseclip	2 (51)	1	3.75 (95)	1.98 (50)	2.01 (51)	1.19 (30)	4.54 (115)	1.51 (38)	0.4 (10)	A3354710*
Enclosed fuseclip	3 (76)	1	4.14 (105)	2.45 (62)	3.01 (76)	1.19 (30)	5.64 (143)	1.51 (38)	0.4 (10)	A3354730*
Open fuseclip	3 (76)	2	See dimensions drawing							1A0065
Spring loaded open fuse-clip	3 (76)	3	See dimensions drawing							9078A67G04

*For single barrel applications only. Not sold in pairs.

Figure 1

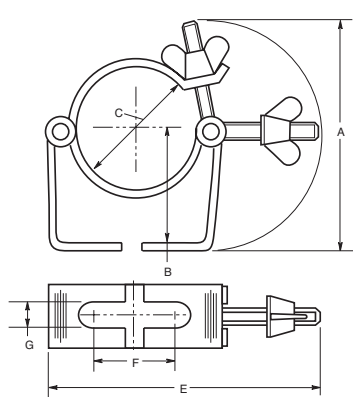

Figure 2

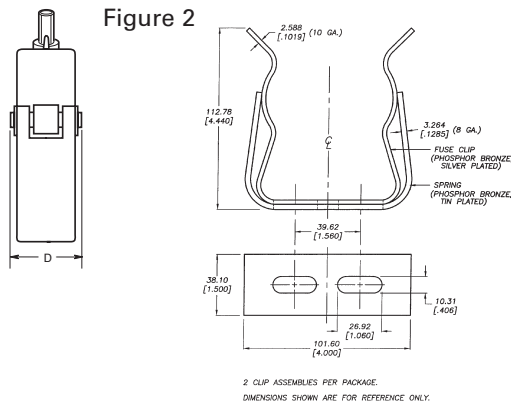
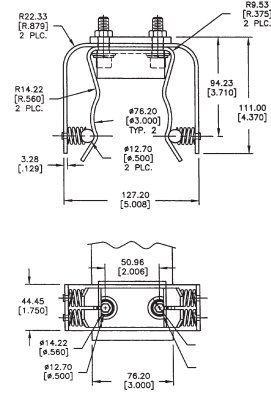

Figure 3



15.5kV Time-current curves – minimum melt for MV155 2 inch diameter fuses



MV155_ (2 inch diameter)

15.5kV time-current curves — total clear for MV155_ 2 inch diameter fuses



MV155_ (2 inch diameter)

15.5kV time-current curves – minimum melt for MV155_ 3 inch diameter fuses



15.5kV time-current curves — total clear for MV155_ 3 inch diameter fuses



MV155_ (3 inch diameter)

15.5kV peak let-through for MV155_ 2 and 3 inch diameter fuses



MV155_ (2 and 3 inch diameter)

15.5kV time-current curves — minimum melt for 15LHLE_ 3 inch diameter fuses

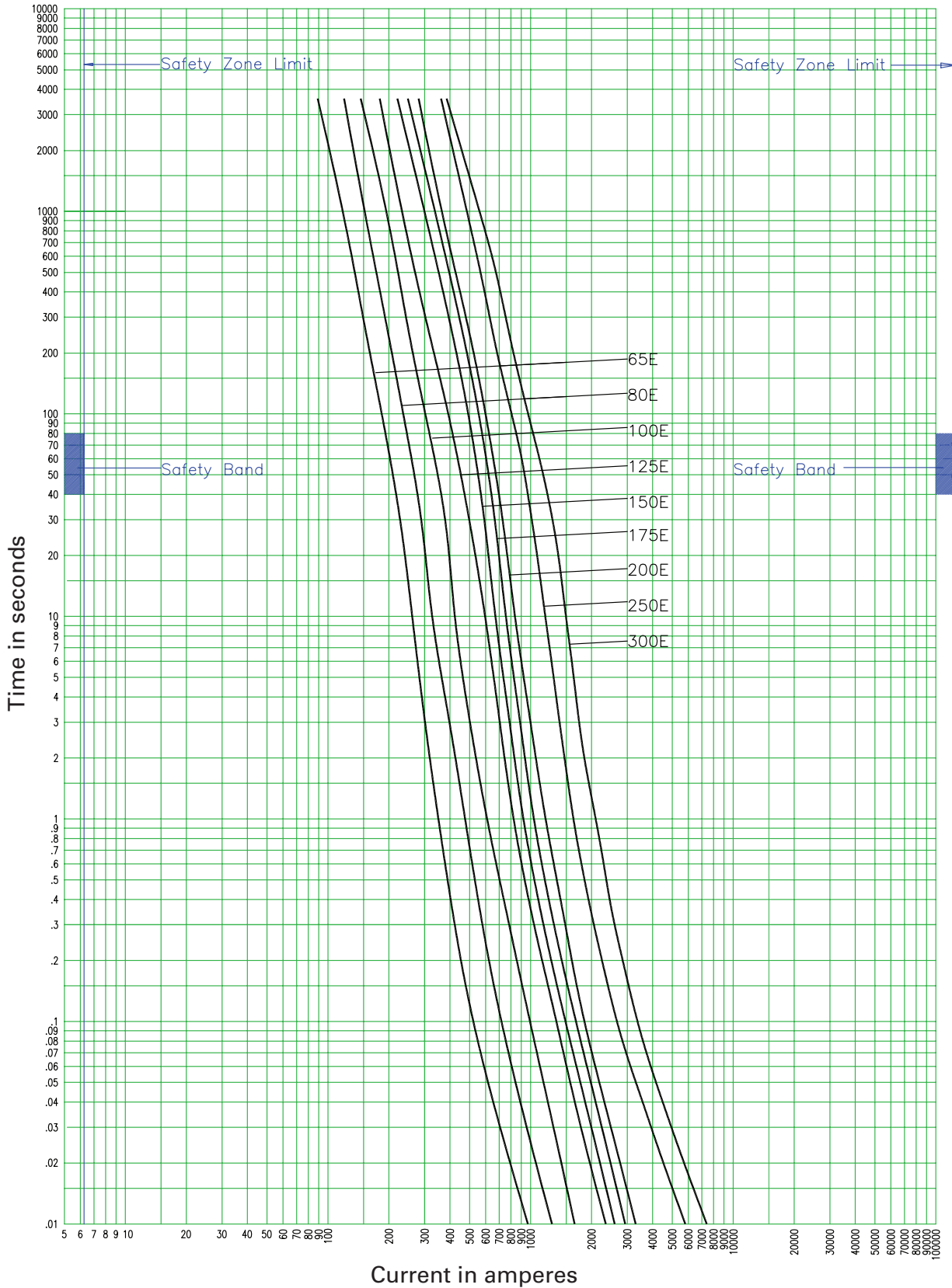

15LHLE_ (3 inch diameter)

Curve TC66703203
April 2011

15.5kV time-current curves – total clear for 15LHLE_ 3 inch diameter fuses

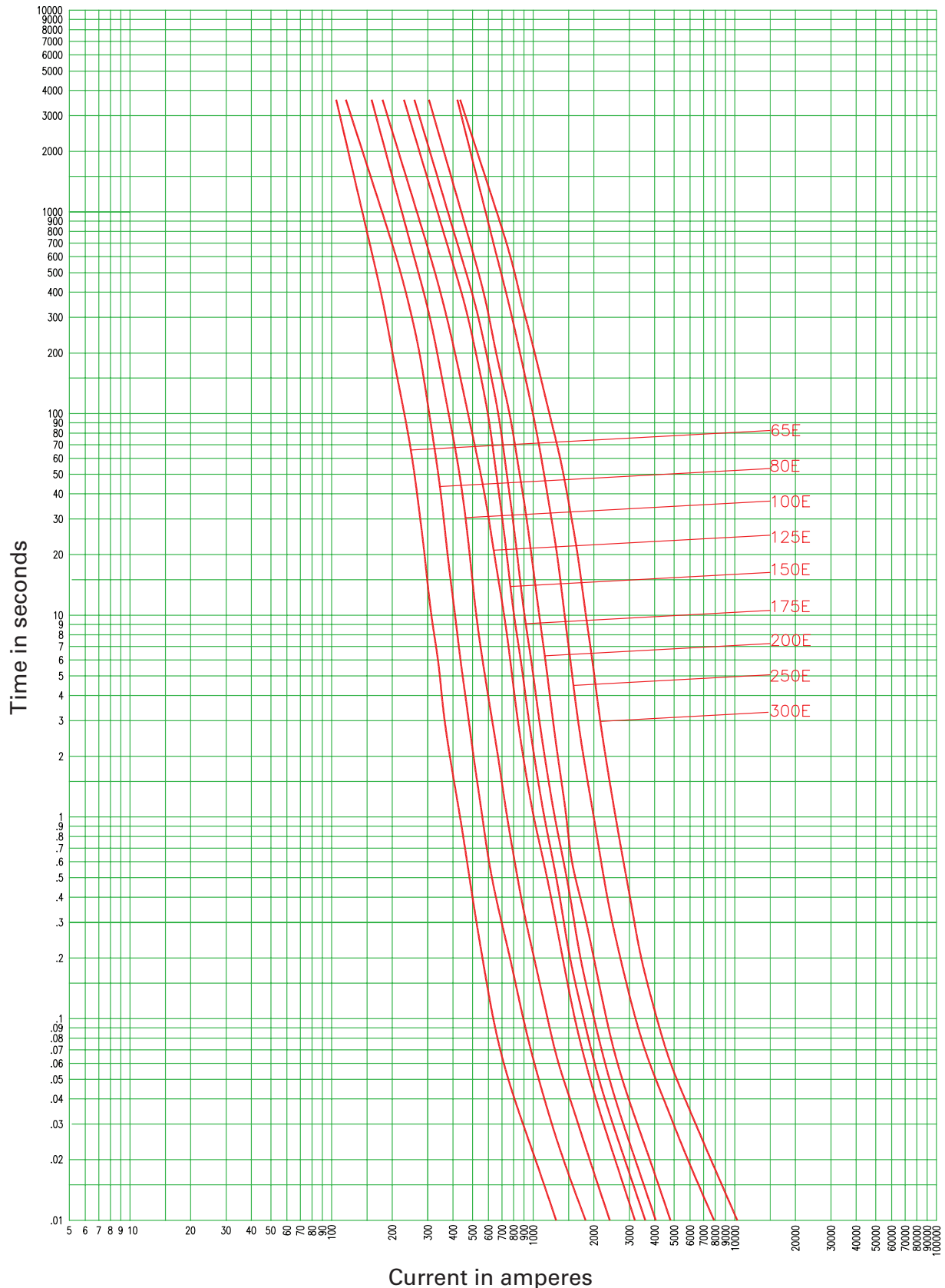

15LHLE_ (3 inch diameter)

Curve TC66703303
April 2011

15.5kV peak let-through for 15LHLE_ 3 inch diameter fuses



15LHLE_ (3 inch diameter)

Curve TC70547404
April 2011

CLE and HLE type mountings - in (mm)

Catalog number	Hole centers		Overall length C	Hole Inset D	Hole centers E	Contact height F	Overall height G	BIL kV
	A	B						
Disconnect single barrel†								
15CLE-GDM-C	21.24 (539.5)	6 (152.4)	34 (863.6)	0.75 (19.0)	1.75 (44.4)	7 (177.8)	12.25 (311.1)	95
15CLE-GDM-D	21.15 (537.2)	6 (152.4)	31 (787.4)	0.62 (15.7)	1.75 (44.4)	7 (177.8)	14.22 (361.2)	95
15CLE-PDM-C	21.24 (539.5)	6 (152.4)	34 (863.6)	0.75 (19.0)	1.75 (44.4)	7 (177.8)	12.25 (311.1)	95
15CLE-PDM-D	21.15 (537.2)	6 (152.4)	31 (787.4)	0.62 (15.7)	1.75 (44.4)	7 (177.8)	14.22 (361.2)	95
15CLE-HPDM-C	21.24 (539.5)	6 (152.4)	34 (863.6)	0.75 (19.0)	1.75 (44.4)	8.5 (215.9)	13.75 (349.2)	110
15CLE-HPDM-D	21.15 (537.2)	6 (152.4)	31 (787.4)	0.62 (15.7)	1.75 (44.4)	8.5 (215.9)	15.72 (399.3)	110
15HLE-GDM-D	16.25 (412.8)	6 (152.4)	25 (647.7)	0.62 (15.7)	1.75 (44.4)	7 (177.8)	14.22 (361.2)	95
15HLE-PDM-D	16.25 (412.8)	6 (152.4)	25 (647.7)	0.62 (15.7)	1.75 (44.4)	7 (177.8)	14.22 (361.2)	95
Disconnect double barrel†								
15CLE-PDM-E	21.15 (537.2)	6 (152.4)	31 (787.4)	0.62 (15.7)	1.75 (44.4)	8.5 (215.9)	19.28 (489.7)	95
15HLE-GDM-E	16.25 (412.8)	6 (152.4)	25 (635)	0.62 (15.7)	1.75 (44.4)	7 (177.8)	17.78 (451.6)	95
15HLE-PDM-E	16.25 (412.8)	6 (152.4)	25 (635)	0.62 (15.7)	1.75 (44.4)	7 (177.8)	17.78 (451.6)	95
Non-disconnect single barrel								
15CLE-GNM-C	21.25 (539.7)	6 (152.4)	30.5 (774.7)	0.75 (19.0)	1.75 (44.4)	7 (177.8)	9.75 (247.6)	95
15CLE-PNM-C	21.25 (539.7)	6 (152.4)	30.5 (774.7)	0.75 (19.0)	1.75 (44.4)	7 (177.8)	9.75 (247.6)	95
15CLE-HPNM-C	21.25 (539.7)	6 (152.4)	30.5 (774.7)	0.75 (19.0)	1.75 (44.4)	8.5 (215.9)	11.25 (285.7)	110
15CLE-GNM-D	21.15 (539.7)	6 (152.4)	31 (787.4)	0.62 (15.7)	1.75 (44.4)	7 (177.8)	11.29 (286.7)	95
15CLE-PNM-D	21.15 (539.7)	6 (152.4)	31 (787.4)	0.62 (15.7)	1.75 (44.4)	7 (177.8)	11.29 (286.7)	95
15CLE-HPNM-D	21.15 (539.7)	6 (152.4)	31 (787.4)	0.62 (15.7)	1.75 (44.4)	8.5 (215.9)	12.79 (286.7)	110
15HLE-GNM-D	16.25 (412.7)	6 (152.4)	25 (635)	0.62 (15.7)	1.75 (44.4)	7 (177.8)	11.29 (286.7)	95
15HLE-PNM-D	16.25 (412.7)	6 (152.4)	25 (635)	0.62 (15.7)	1.75 (44.4)	7 (177.8)	11.29 (286.7)	95
Non-disconnect double barrel								
15CLE-PNM-E	21.15 (539.7)	6 (152.4)	31 (787.4)	0.62 (15.7)	1.75 (44.4)	8.5 (215.9)	14.98 (380.5)	95
15HLE-GNM-E	16.25 (412.7)	6 (152.4)	25 (635)	0.62 (15.7)	1.75 (44.4)	7 (177.8)	14.98 (380.5)	95
15HLE-PNM-E	16.25 (412.7)	6 (152.4)	25 (635)	0.62 (15.7)	1.75 (44.4)	7 (177.8)	14.98 (380.5)	95

CLE and HLE type disconnect mounting†



CLE and HLE type non-disconnect mounting



† Disconnect mountings provide a means for fuse extraction only. Do not use a disconnect mounting for load switching or fuse removal while energized.

E-Rated medium voltage specialty mount fuses

Catalog symbols:

- 15BHLE_E (bolt-on version)
- 15HCL_E (clip-lock version)

Ratings*:

- Volts
 - 15.5kV
- Amps
 - 10 to 300A
- Interrupting ratings
 - 50 to 63kA RMS Sym

* See catalog number tables for voltages, ampacities and interrupting ratings by catalog number.

Agency information:

- E-Rated fuses meet the performance characteristics of ANSI C37.46

Recommended live parts for clip-lock fuses

- Catalog number HCL-NL-1

HCL

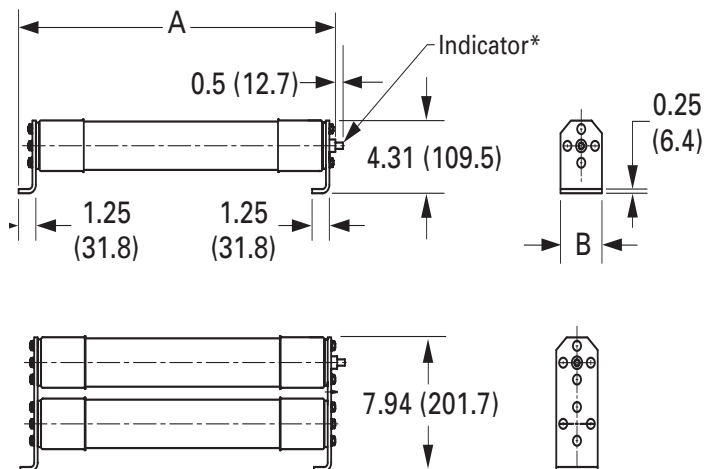

Dimensions - in (mm)

BHLE

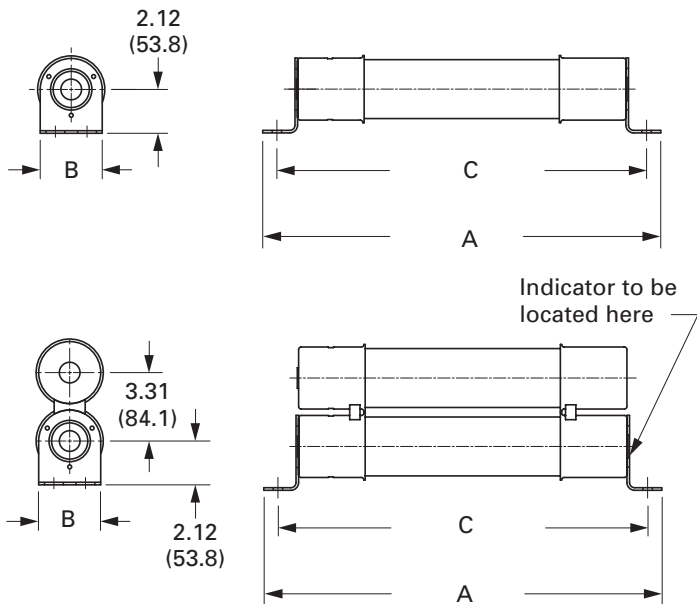

BHCL, BHLE and HCL Type fuses

Amp rating	Dimensions - in (mm)			Interrupting rating kA (RMS Sym.)	Number of barrels	Installation location	Catalog number
	Length A	Diameter B	Hole centers C				
BHCL and BHLE bolt-on							
10	22.2 (563)	3 (76)	20.9 (531)	63	1	Indoor/outdoor	15BHLE-10E
15	22.2 (563)	3 (76)	20.9 (531)	63	1	Indoor/outdoor	15BHLE-15E
20	22.2 (563)	3 (76)	20.9 (531)	63	1	Indoor/outdoor	15BHLE-20E
25	22.2 (563)	3 (76)	20.9 (531)	63	1	Indoor/outdoor	15BHLE-25E
30	22.2 (563)	3 (76)	20.9 (531)	63	1	Indoor/outdoor	15BHLE-30E
40	22.2 (563)	3 (76)	20.9 (531)	63	1	Indoor/outdoor	15BHLE-40E†
50	22.2 (563)	3 (76)	20.9 (531)	63	1	Indoor/outdoor	15BHLE-50E†
65	22.2 (563)	3 (76)	20.9 (531)	63	1	Indoor/outdoor	15BHLE-65E†
80	22.2 (563)	3 (76)	20.9 (531)	63	1	Indoor/outdoor	15BHLE-80E†
100	22.2 (563)	3 (76)	20.9 (531)	63	1	Indoor/outdoor	15BHLE-100E†
125	22.2 (563)	3 (76)	20.9 (531)	63	1	Indoor/outdoor	15BHLE-125E†
150	22.2 (563)	3 (76)	20.9 (531)	63	2	Indoor/outdoor	15BHLE-150E†
175	22.2 (563)	3 (76)	20.9 (531)	63	2	Indoor/outdoor	15BHLE-175E†
200	22.2 (563)	3 (76)	20.9 (531)	63	2	Indoor/outdoor	15BHLE-200E†
250	22.2 (563)	3 (76)	20.9 (531)	63	2	Indoor/outdoor	15BHLE-250E†
300	25.1 (637)	3 (76)	23.7 (602)	50	2	Indoor	15BHCL-300E
400	25.1 (637)	3 (76)	23.7 (602)	50	3	Indoor	15BHCL-400E
HCL clip-lock							
10	22.8 (579)	3 (76)	N/A	63	1	Indoor	15HCL-10E
15	22.8 (579)	3 (76)	N/A	63	1	Indoor	15HCL-15E
20	22.8 (579)	3 (76)	N/A	63	1	Indoor	15HCL-20E
25	22.8 (579)	3 (76)	N/A	63	1	Indoor	15HCL-25E
30	22.8 (579)	3 (76)	N/A	63	1	Indoor	15HCL-30E
40	22.8 (579)	3 (76)	N/A	63	1	Indoor	15HCL-40E†
50	22.8 (579)	3 (76)	N/A	63	1	Indoor	15HCL-50E†
65	22.8 (579)	3 (76)	N/A	50	1	Indoor	15HCL-65E†
80	22.8 (579)	3 (76)	N/A	50	1	Indoor	15HCL-80E†
100	22.8 (579)	3 (76)	N/A	50	1	Indoor	15HCL-100E†
125	22.8 (579)	3 (76)	N/A	50	1	Indoor	15HCL-125E†
150	22.8 (579)	3 (76)	N/A	50	2	Indoor	15HCL-150E†
200	22.8 (579)	3 (76)	N/A	50	2	Indoor	15HCL-200E†
250	22.8 (579)	3 (76)	N/A	50	2	Indoor	15HCL-250E†
300	22.8 (579)	3 (76)	N/A	50	2	Indoor	15HCL-300E†

† UL Listed, Guide JEEG, File E240398.

15.5kV time-current curves — minimum melt for 15CLE-_E and 15CLE_-_D



15CLE-_

Curve 70548501	Curve 70546801	Curve 70547001
April 16, 1999	April 1999	April 1999
Reference # 563532	Reference # 705468	Reference # 705470

15.5kV time-current curves — total clear for 15CLE-_E and 15CLE_-_D



15CLE-_

Current in amperes

Curve 70548601

April 16, 1999

Reference # 563533

Curve 70546901

April 1999

Reference # 705469

Curve 70547101

April 1999

Reference # 705471

15.5kV peak let-through for 15CLE-_E and 15CLE-_D

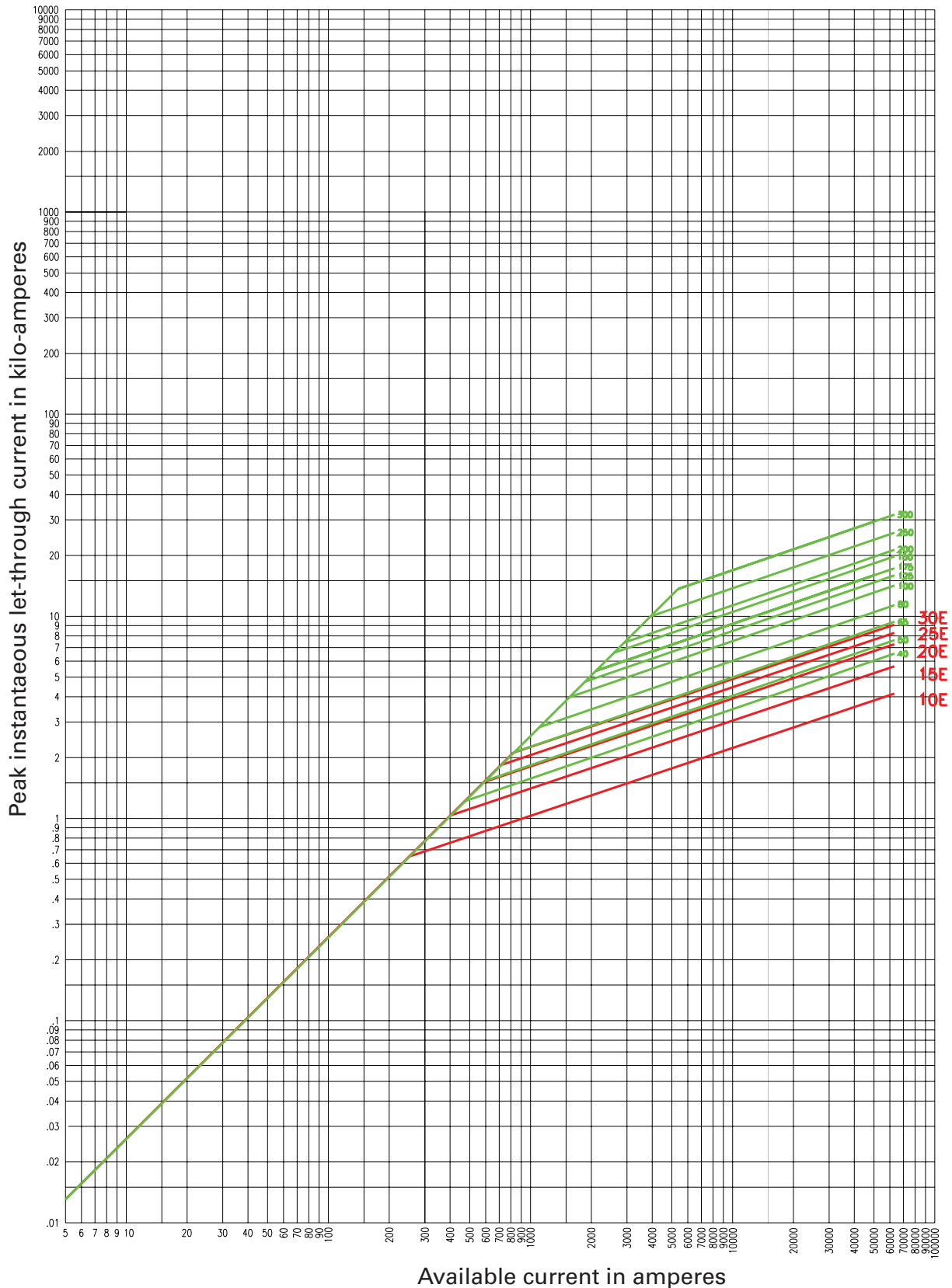

15CLE-_

Curve 70548802 Curve 70547501
 September 1999 September 1999
 Reference # 705488 Reference # 705475

15.5kV time-current curves – minimum melt for 15HLE-_E and 15BHLE-_E



15HLE-_E, 15BHLE-_E

Curve 70548507
April 16, 1999
Reference # 563532

Curve 70546601
April 1999
Reference # 705466

15.5kV time-current curves — total clear for 15HLE-_E and 15BHLE-_E

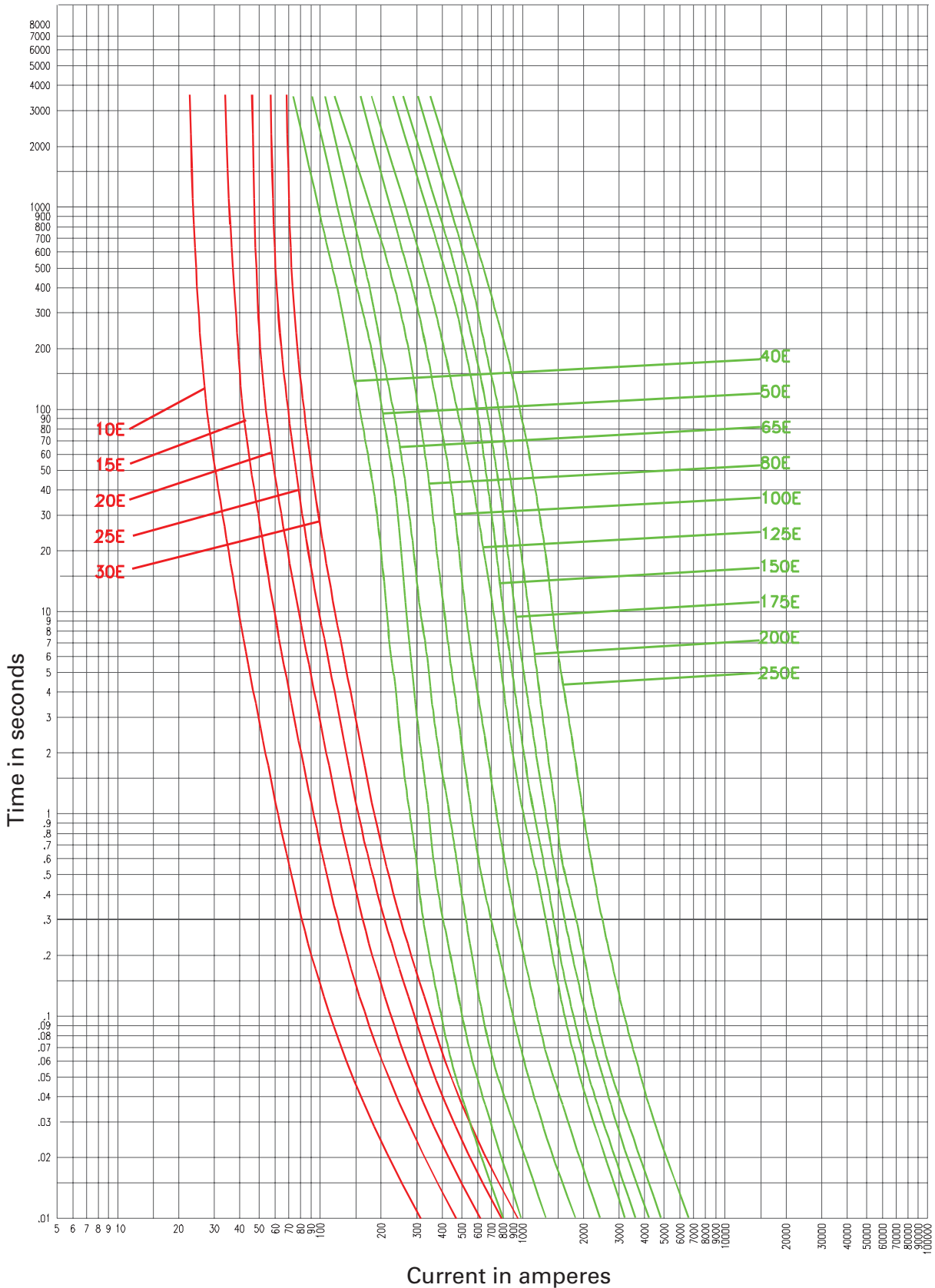

15HLE-_, 15BHLE-_

Curve 70548607 Curve 70546701
April 16, 1999 April 1999
Reference # 563533 Reference # 705467

15.5kV peak let-through for 15HLE-_E and 15BHLE-_E



15HLE-_, 15BHLE-_

Curve 70548805 Curve 70547401
September 1999 September 1999
Reference # 705488 Reference # 705474

15.5kV time-current curves – minimum melt for 15HCL_E



15HCL_

Curve 70548503 January 2001 Curve 66703201 January 2001

15.5kV time-current curves — total clear for 15HCL_E



15HCL_

Curve 70548603 Curve 66703301
January 2001 January 2001

15.5kV peak let-through for 15HCL_E

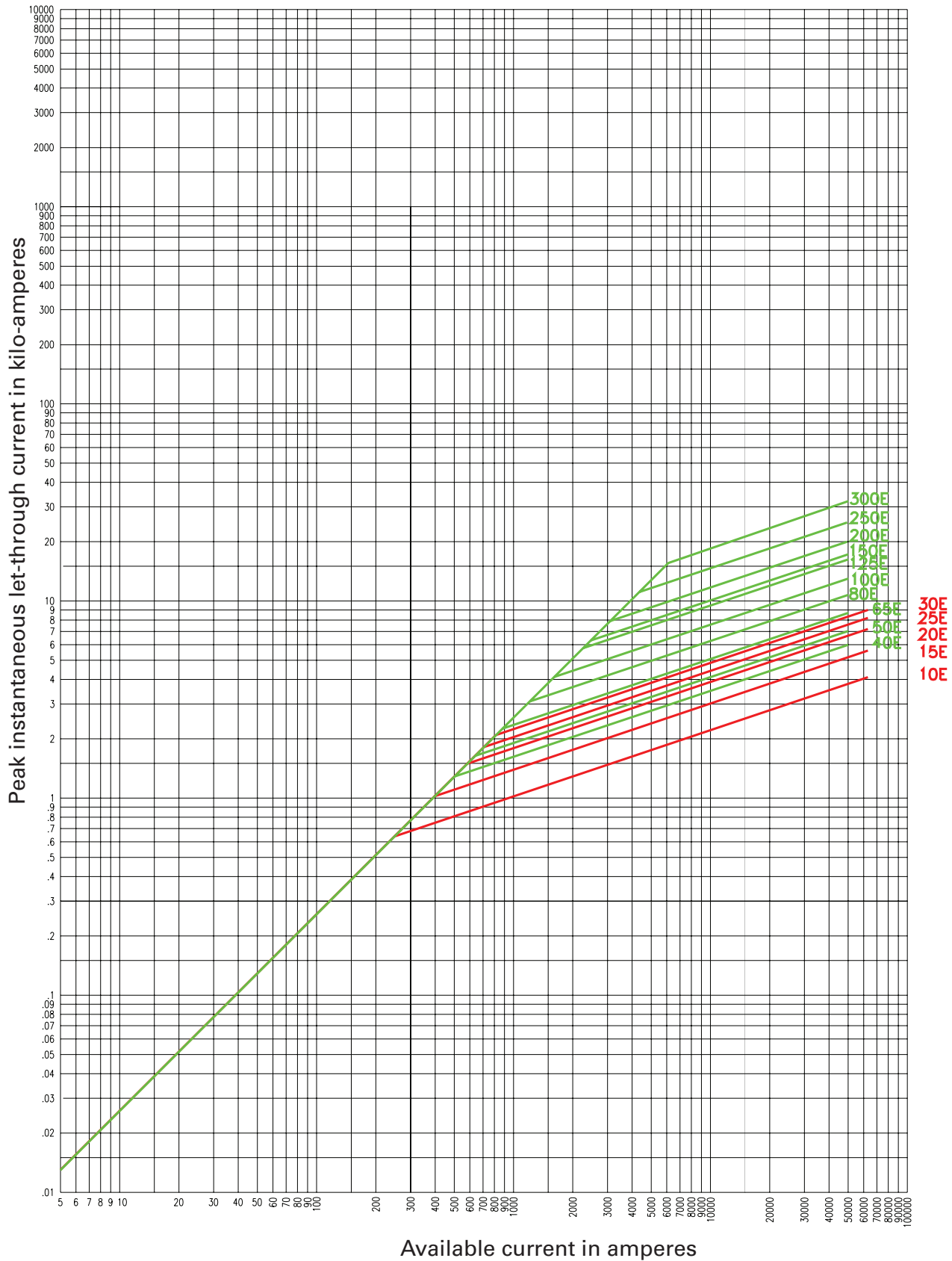

15HCL_

Curve 70548803 January 2001
 Curve 70547402 January 2001

The only controlled copy of this data sheet is the electronic read-only version located on the Eaton network drive. All other copies of this document are by definition uncontrolled. This bulletin is intended to clearly present comprehensive product data and provide technical information that will help the end user with design applications. Eaton reserves the right, without notice, to change design or construction of any products and to discontinue or limit distribution of any products. Eaton also reserves the right to change or update, without notice, any technical information contained in this bulletin. Once a product has been selected, it should be tested by the user in all possible applications.

Eaton
1000 Eaton Boulevard
Cleveland, OH 44122
United States
Eaton.com

Bussmann Division
114 Old State Road
Ellisville, MO 63021
United States
Eaton.com/bussmannseries

© 2015 Eaton
All Rights Reserved
Printed in USA
Publication No. 10353 – BU-SB15153
December 2015

Eaton, Bussmann, AMPGARD are valuable trademarks of Eaton in the US and other countries. You are not permitted to use the Eaton trademarks without prior written consent of Eaton.

UL is a registered trademark of the Underwriters Laboratories, Inc.

For Eaton's Bussmann series
product information,
call **1-855-287-7626** or visit:
Eaton.com/bussmannseries

Follow us on social media to get the latest product and support information.





Компания «ЭлектроПласт» предлагает заключение долгосрочных отношений при поставках импортных электронных компонентов на взаимовыгодных условиях!

Наши преимущества:

- Оперативные поставки широкого спектра электронных компонентов отечественного и импортного производства напрямую от производителей и с крупнейших мировых складов;
- Поставка более 17-ти миллионов наименований электронных компонентов;
- Поставка сложных, дефицитных, либо снятых с производства позиций;
- Оперативные сроки поставки под заказ (от 5 рабочих дней);
- Экспресс доставка в любую точку России;
- Техническая поддержка проекта, помощь в подборе аналогов, поставка прототипов;
- Система менеджмента качества сертифицирована по Международному стандарту ISO 9001;
- Лицензия ФСБ на осуществление работ с использованием сведений, составляющих государственную тайну;
- Поставка специализированных компонентов (Xilinx, Altera, Analog Devices, Intersil, Interpoint, Microsemi, Aeroflex, Peregrine, Syfer, Eurofarad, Texas Instrument, Miteq, Cobham, E2V, MA-COM, Hittite, Mini-Circuits, General Dynamics и др.);

Помимо этого, одним из направлений компании «ЭлектроПласт» является направление «Источники питания». Мы предлагаем Вам помощь Конструкторского отдела:

- Подбор оптимального решения, техническое обоснование при выборе компонента;
- Подбор аналогов;
- Консультации по применению компонента;
- Поставка образцов и прототипов;
- Техническая поддержка проекта;
- Защита от снятия компонента с производства.



Как с нами связаться

Телефон: 8 (812) 309 58 32 (многоканальный)

Факс: 8 (812) 320-02-42

Электронная почта: org@eplast1.ru

Адрес: 198099, г. Санкт-Петербург, ул. Калинина, дом 2, корпус 4, литера А.