

GENERAL DESCRIPTION

The SP7652 is a synchronous voltage mode PWM step down (buck) regulator capable of a constant output current up to 6Amps. A wide 2.5V to 28V power input voltage range, with the required 5V biasing voltage, allows conversions from industry standard 5V, 12V, 18V and 24V power rails.

With a 600kHz constant operating frequency and integrated high and low side switch, the SP7652 reduces the overall component count and solution footprint. In addition to a 1% output setpoint accuracy, this device provides high efficiency, low ripple and excellent line and load regulation. An enable function and soft start feature allow for controlled power up sequencing implementation.

Built-in Under voltage lockout (VLO) on both V_{CC} and V_{IN} , outputs short-circuit and over temperature protection insure safe operation under abnormal operating conditions.

The SP7652 is offered in a RoHS compliant, lead free 26-pin 7mmx4mm DFN package.

APPLICATIONS

- **Distributed Power Architectures**
- **Point of Load Converters**
- **Power Supply Modules**
- **FPGAs, DSPs and Processors Supplies**

FEATURES

- **6A Continuous Current**
- **2.5V-28V Power Input Voltage Rail**
 - 5V Biasing voltage
 - 0.8V Min. Output Voltage – 1% Accuracy
- **PWM Voltage Mode Control**
 - 600kHz Fixed Synchronous Operations
 - Low RDS(on) Power Switches
 - Greater than 92% Efficiency
- **Type II & III Compensations Support**
- **Programmable Soft Start**
- **UVLO on both V_{IN} and V_{CC}**
- **Pre-biased Output Start-Up**
- **Over Temperature & Short Circuit Protection/Auto-Restart**
- **RoHS Compliant Lead Free 26-Pin DFN**
- **US Patent #6,922,041**

TYPICAL APPLICATION DIAGRAM

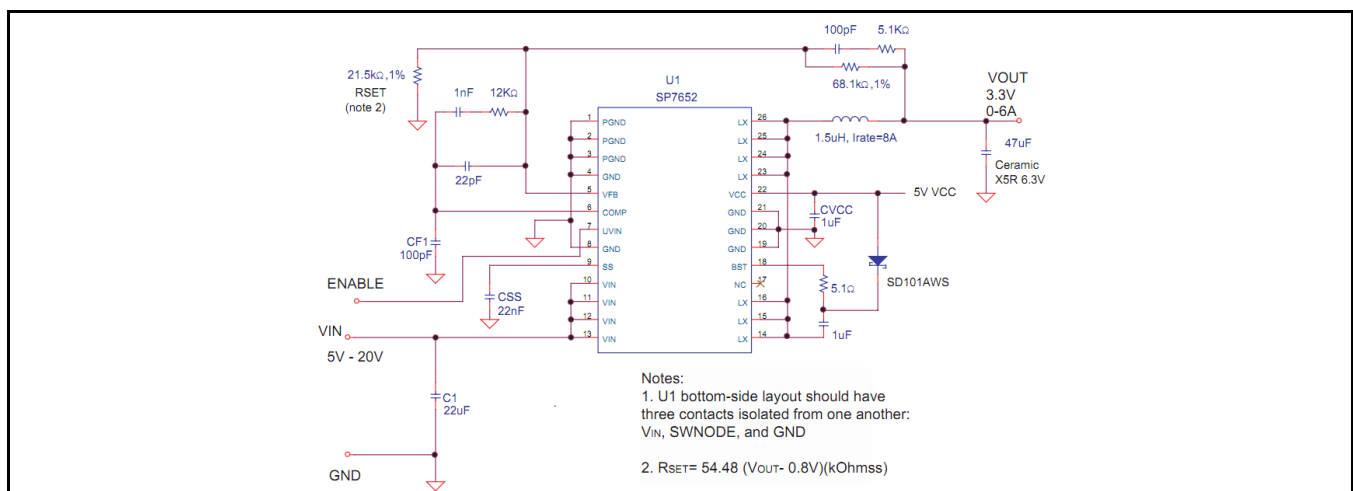

Fig. 1: SP7652 Application Diagram



6A 28V 600KHz Synchronous Step Down Regulator

ABSOLUTE MAXIMUM RATINGS

These are stress ratings only and functional operation of the device at these ratings or any other above those indicated in the operation sections of the specifications below is not implied. Exposure to absolute maximum rating conditions for extended periods of time may affect reliability.

- V_{IN} 30V
- V_{CC} 7V
- I_{LX} 10A
- BST 35V
- LX-BST..... -0.3V to 7V
- LX -1V to 30V
- All other pins -0.3V to (V_{CC}+0.3)V
- Storage Temperature -65°C to 150°C
- Power Dissipation Internally Limited
- Lead Temperature (Soldering, 10 sec)..... 300°C
- ESD Rating (HBM - Human Body Model) 2kV HBM

OPERATING RATINGS

- Input Voltage Range V_{CC}4.5V to 5.5V
- Input Voltage Range V_{IN}..... 3V to 28V
- Junction Temperature Range -40°C to +125°C
- Thermal Resistance θ_{JC} 5°C/W
- Thermal Resistance θ_{JA} 36°C/W

ELECTRICAL SPECIFICATIONS

Specifications with standard type are for an Operating Junction Temperature of T_J = T_A = 25°C only; limits applying over the full Operating Junction Temperature range are denoted by a “•”. Minimum and Maximum limits are guaranteed through test, design, or statistical correlation. Typical values represent the most likely parametric norm at T_J = T_A = 25°C, and are provided for reference purposes only. Unless otherwise indicated, V_{CC} = 4.5V to 5.5V, V_{IN} = 3.0V to 28V, BST = LX + 5V, LX = GND = 0V, UVIN = 3V, CV_{CC} = 1µF, C_{COMP} = 0.1µF, C_{SS} = 50nF, T_A = -40°C to 85°C, T_J = -40°C to 125°C.

Parameter	Min.	Typ.	Max.	Units	Conditions
Quiescent Current					
V _{CC} Supply Current (No Switching)		1.5	3	mA	V _{FB} = 0.9V
V _{CC} Supply Current (Switching)		11	15	mA	•
BST Supply Current (No Switching)		0.2	0.4	mA	V _{FB} = 0.9V
BST Supply Current (Switching)		8	12	mA	•
Protection: UVLO					
V _{CC} UVLO Start Threshold	4.00	4.25	4.5	v	
V _{CC} UVLO Hysteresis	100	200	300	mV	
UVIN Start Threshold	2.3	2.5	2.65	V	•
UVIN Hysteresis	200	300	400	mV	
UVIN Input Current			1	µA	UVIN = 3.0V
Error Amplifier Reference					
Error Amplifier Reference	0.792	0.800	0.808	V	2x Gain Config., Measure V _{FB} ; V _{CC} =5V, T=25°C
Error Amplifier Reference Over Line and Temperature	0.788	0.800	0.812	V	•
Error Amplifier Transconductance		6		mA/V	
Error Amplifier Gain		60		dB	No Load
COMP Sink Current		150		µA	V _{FB} = 0.9V, COMP = 0.9V
COMP Source Current		150		µA	V _{FB} = 0.7V, COMP = 2.2V
V _{FB} Input Bias Current		50	200	nA	V _{FB} = 0.8V
Internal Pole		4		MHz	
COMP Clamp		2.5		V	V _{FB} = 0.7V, T _A =25°C
COMP Clamp Temp. Coefficient		-2		mV/°C	



6A 28V 600KHz Synchronous Step Down Regulator

Parameter	Min.	Typ.	Max.	Units	Conditions
Control Loop: PWM Comparator, Ramp & Loop Delay Path					
Ramp Amplitude	0.92	1.1	1.28	V	
Ramp Offset		1.1		V	• $T_A=25^\circ\text{C}$, Ramp COMP
Ramp Offset Temp. Coefficient		-2		mV/°C	
GH Minimum Pulse width		90	180	ns	•
Maximum Controllable Duty Ratio	92	97		%	Maximum Duty Ratio measured just before pulsing begins
Maximum Duty Ratio	100			%	Valid for 20 cycles
Internal Oscillator Ratio	420	600	720	kHz	•
Timers: Soft Start					
SS Charge Current		10		μA	
SS Discharge Current	1			mA	• Fault Present, SS = 0.2V
Protection: Short Circuit & Thermal					
Short Circuit Threshold Voltage	0.2	0.25	0.3	V	• Measured ($V_{\text{REF}}(0.8\text{V})-V_{\text{FB}}$)
Hiccup Timeout		200		ms	$V_{\text{FB}} = 0.5\text{V}$
Number of Allowable Clock Cycles at 100% Duty Cycle		20		Cycles	
Minimum GL Pulse After 20 Cycles		0.5		Cycles	$V_{\text{FB}} = 0.7\text{V}$
Thermal Shutdown Temperature		145		°C	$V_{\text{FB}} = 0.7\text{V}$
Thermal Recovery Temperature		135		°C	
Thermal Hysteresis		10		°C	
Output: Power Stage					
High Side RDS _{ON}		15		m Ω	$V_{\text{CC}} = 5\text{V}$; $I_{\text{OUT}} = 6\text{A}$, $T_A = 25^\circ\text{C}$
Synchronous FET RDS _{ON}		15		m Ω	$V_{\text{CC}} = 5\text{V}$; $I_{\text{OUT}} = 6\text{A}$, $T_A = 25^\circ\text{C}$
Maximum Output Current	6			A	

PIN ASSIGNMENT

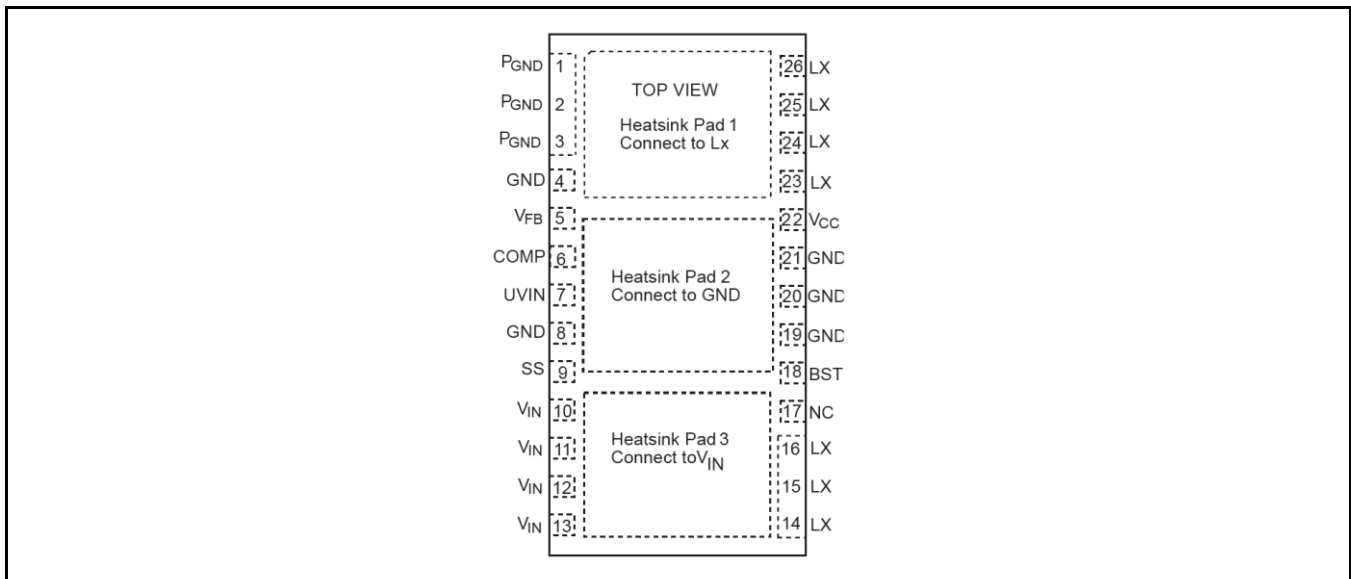

Fig. 2: SP7652 Pin Assignment



PIN DESCRIPTION

Name	Pin Number	Description
P _{GND}	1, 2, 3	Ground connection for the synchronous rectifier.
GND	4, 8, 19, 20, 21	Ground Pin. The control circuitry of the IC and lower power driver are referenced to this pin. Return separately from other ground traces to the (-) terminal of C _{OUT} .
V _{FB}	5	Feedback Voltage and Short Circuit Detection pin. The inverting input of the Error Amplifier and serves as the output voltage feedback point for the Buck Converter. The output voltage is sensed and can be adjusted through an external resistor divider. Whenever V _{FB} drops 0.25V below the positive reference, a short circuit fault is detected and the IC enters hiccup mode.
COMP	6	Output of the Error Amplifier. Internally connected to the inverting input of the PWM comparator. An optimal filter combination is chosen and connected to this pin and either ground or V _{FB} to stabilize the voltage mode loop.
UVIN	7	UVLO input for V _{IN} voltage. Connect a resistor divider between V _{IN} and UV _{IN} to set minimum operating voltage.
SS	9	Soft Start. Connect an external capacitor between SS and GND to set the soft start rate based on the 10µA source current. The SS pin is held low via a 1mA (min.) current during all fault conditions.
V _{IN}	10, 11, 12, 13	Input connection to the high-side N-channel MOSFET. Place a decoupling capacitor between this pin and P _{GND} .
LX	14, 15, 16, 23, 24, 25, 26	Connect an inductor between this pin and V _{OUT} .
NC	17	No Connect.
BST	18	High-side driver supply pin. Connect BST to the external boost diode and capacitor as shown in the Typical Application Circuit on page one. High-side driver is connected between BST and SWN pin.
V _{CC}	22	Input for external 5V bias supply
-	Exposed Pad 1	Exposed Pad 1 Connect to LX through PCB.
-	Exposed Pad 2	Exposed Pad 1 Connect to GND through PCB.
-	Exposed Pad 3	Exposed Pad 1 Connect to V _{IN} through PCB.

ORDERING INFORMATION

Part Number	Junction Temperature Range	Marking	Package	Packing Quantity	Note 1	Note 2
SP7652ER-L	-40°C ≤ T _J ≤ +125°C	SP7652ER YYWWL X	7mm x 4mm 26-pin DFN	Bulk	Lead Free	
SP7652ER-L/TR				3K/Tape & Reel	Lead Free	
SP7662EB	SP7652 Evaluation Board					

“YY” = Year - “WW” = Work Week - “X” = Lot Number; when applicable.

TYPICAL PERFORMANCE CHARACTERISTICS

All data taken at $V_{IN} = 2.7V$ to $5.5V$, $T_J = T_A = 25^\circ C$, unless otherwise specified - Schematic and BOM from Application Information section of this datasheet.

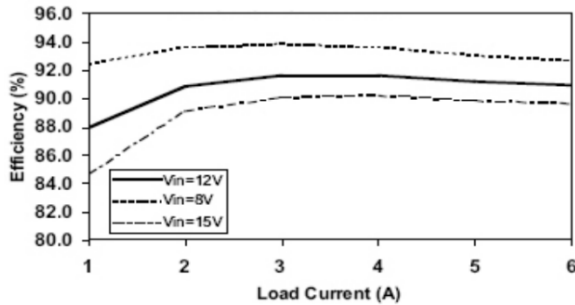

Fig. 3: Efficiency versus Output Current
 $V_{IN}=8V, 12V$ and $15V$, $V_{OUT}=5V$

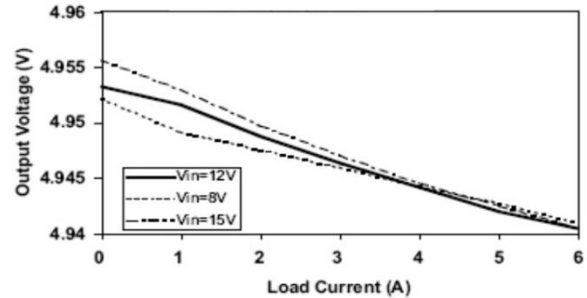

Fig. 4: Output Voltage versus Output Current
 $V_{IN}=8V, 12V$ and $15V$

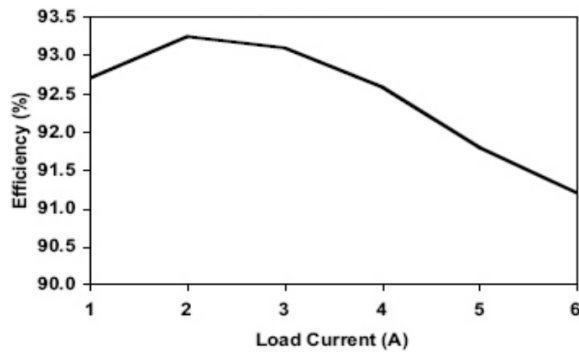

Fig. 5: Efficiency versus Output Current
 $V_{IN}=5V, V_{OUT}=3.3V$

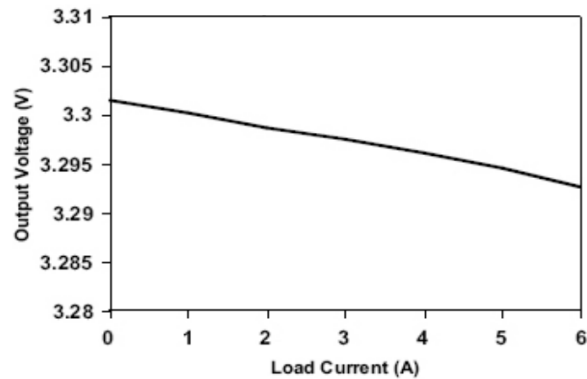

Fig. 6: Output Voltage versus Output Current
 $V_{IN}=5V, V_{OUT}=3.3V$

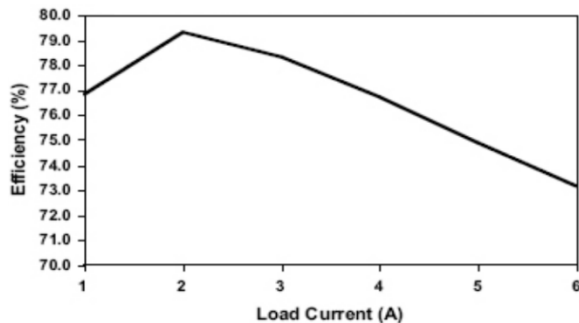

Fig. 7: Efficiency versus Output Current
 $V_{IN}=3.3V, V_{OUT}=0.8V$

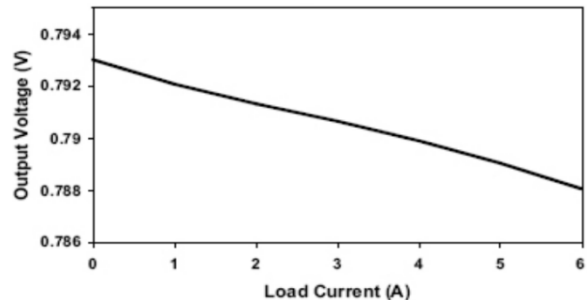

Fig. 8: Output Voltage versus Output Current
 $V_{IN}=3.3V, V_{OUT}=0.8V$

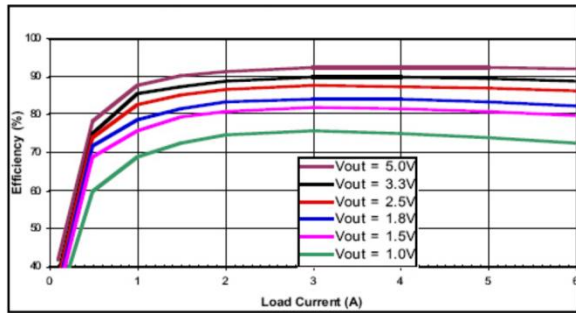

Fig. 9: Efficiency versus Output Current
 $V_{IN}=12V$

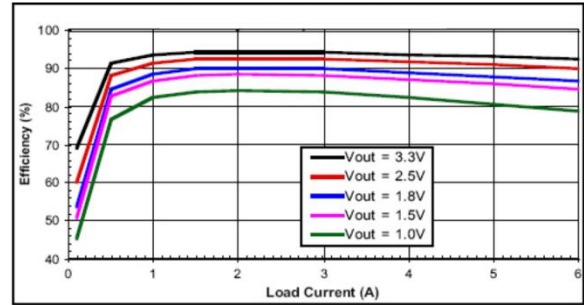

Fig. 10: Efficiency versus Output Current
 $V_{IN}=5V$

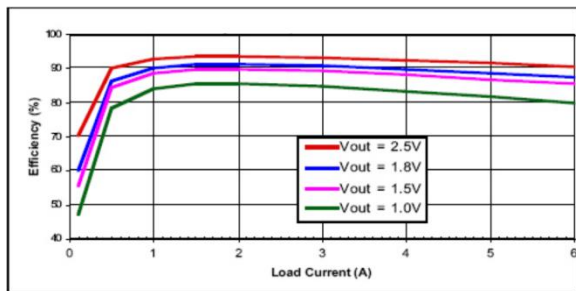

Fig. 11: Efficiency versus Output Current
 $V_{IN}=3.3V$



THEORY OF OPERATION

GENERAL OVERVIEW

The SP7652 is a fixed frequency, voltage mode, synchronous PWM regulator optimized for high efficiency. The part has been designed to be especially attractive for split plane applications utilizing 5V to power the controller and 3V to 20V for step down conversion.

The heart of the SP7652 is a wide bandwidth transconductance amplifier designed to accommodate Type II and Type III compensation schemes. A precision 0.8V reference, present on the positive terminal of the error amplifier, permits the programming of the output voltage down to 0.8V via the V_{FB} pin. The output of the error amplifier, COMP, which is compared to a 1.1V peak-to-peak ramp, is responsible for trailing edge PWM control. This voltage ramp and PWM control logic are governed by the internal oscillator that accurately sets the PWM frequency to 600kHz.

The SP7652 contains two unique control features that are very powerful in distributed applications. First, asynchronous driver control is enabled during start up, to prohibit the low side NFET from pulling down the output until the high side NFET has attempted to turn on. Second, a 100% duty cycle timeout ensures that the low side NFET is periodically enhanced during extended periods at 100% duty cycle. This guarantees the synchronized refreshing of the BST capacitor during very large duty cycle ratios.

The SP7652 also contains a number of valuable protection features. Programmable UVLO allows the user to set the exact V_{IN} value at which the conversion voltage can safely begin down conversion, and an internal V_{CC} UVLO ensures that the controller itself has enough voltage to operate properly. Other protection features include thermal shutdown and short-circuit detection. In the event that either a thermal, short-circuit, or UVLO fault is detected, the SP7652 is forced into an idle state where the output drivers are held off for a finite period before a re-start is attempted.

SOFT START

Soft start is achieved when a power converter ramps up the output voltage while controlling the magnitude of the input supply source current. In a modern step down converter, ramping up the positive terminal of the error amplifier controls soft start. As a result, excess source current can be defined as the current required to charge the output capacitor.

$$I_{VIN} = C_{OUT} * (\Delta V_{OUT} / \Delta T_{SOFT-START})$$

The SP7652 provides the user with the option to program the soft start rate by tying a capacitor from the SS pin to GND. The selection of this capacitor is based on the 10 μ A pull up current present at the SS pin and the 0.8V reference voltage. Therefore, the excess source can be redefined as:

$$I_{VIN} = C_{OUT} * (\Delta V_{OUT} * 10\mu A / (C_{SS} * 0.8V))$$

UNDER VOLTAGE LOCK OUT (UVLO)

The SP7652 contains two separate UVLO comparators to monitor the internal bias (V_{CC}) and conversion (V_{IN}) voltages independently. The V_{CC} UVLO threshold is internally set to 4.25V, whereas the V_{IN} UVLO threshold is programmable through the UVIN pin. When the UVIN pin is greater than 2.5V, the SP7652 is permitted to start up pending the removal of all other faults. Both the V_{CC} and V_{IN} UVLO comparators have been designed with hysteresis to prevent noise from resetting a fault.

THERMAL AND SHORT-CIRCUIT PROTECTION

Because the SP7652 is designed to drive large output current, there is a chance that the power converter will become too hot. Therefore, an internal thermal shutdown (145°C) has been included to prevent the IC from malfunctioning at extreme temperatures.

A short-circuit detection comparator has also been included in the SP7652 to protect against an accidental short at the output of the power converter. This comparator constantly monitors the positive and negative terminals of the error amplifier, and if the V_{FB} pin falls more than 250mV (typical) below the positive



6A 28V 600KHz Synchronous Step Down Regulator

reference, a short-circuit fault is set. Because the SS pin overrides the internal 0.8V reference during soft start, the SP7652 is capable of detecting short-circuit faults throughout the duration of soft start as well as in regular operation.

HANDLING OF FAULTS

Upon the detection of power (UVLO), thermal, or short-circuit faults, the SP7652 is forced into an idle state where the SS and COMP pins are pulled low and the NFETS are held off. In the event of UVLO fault, the SP7652 remains in this idle state until the UVLO fault is removed. Upon the detection of a thermal or short-circuit fault, an internal 200ms timer is activated. In the event of a short-circuit fault, a re-start is attempted immediately after the 200ms timeout expires. Whereas, when a thermal fault is detected, the 200ms delay continuously recycles and a re-start cannot be attempted until the thermal fault is removed and the timer expires.

ERROR AMPLIFIER AND VOLTAGE LOOP

Since the heart of the SP7652 voltage error loop is a high performance, wide bandwidth transconductance amplifier, great care should be taken to select the optimal compensation network. Because of the amplifier's current limited ($\pm 150\mu\text{A}$) transconductance, there are many ways to compensate the voltage loop or to control the COMP pin externally. If a simple, single-pole, single-zero response is desired, then compensation can be as simple as an RC circuit to Ground. If a more complex compensation is required, then the amplifier has enough bandwidth (45°C at 4MHz) and enough gain (60dB) to run Type III compensation schemes with adequate gain and phase margins at cross over frequencies greater than 50kHz.

The common mode output of the error amplifier is 0.9V to 2.2V. Therefore, the PWM voltage ramp has been set between 1.1V and 2.2V to ensure proper 0% to 100% duty cycle capability. The voltage loop also includes two other very important features. One is an asynchronous startup mode. Basically, the synchronous rectifier cannot turn on unless the high-side NFET has attempted to turn on

or the SS pin has exceeded 1.7V. This feature prevents the controller from "dragging down" the output voltage during startup or in fault modes. The second feature is a 100% duty cycle timeout that ensures synchronized refreshing of the BST capacitor at very high duty ratios. In the event that the high-side NFET is on for 20 continuous clock cycles, a reset is given to the PWM flip-flop half way through the 21st cycle. This forces GL to rise for the cycle, in turn refreshing the BST capacitor.

POWER MOSFETS

The SP7652 contains a pair of integrated low resistance N-MOSFETs designed to drive up to 6A of output current. Maximum output current could be limited by thermal limitations of a particular application. The SP7652 incorporates a built-in over-temperature protection to prevent internal overheating.

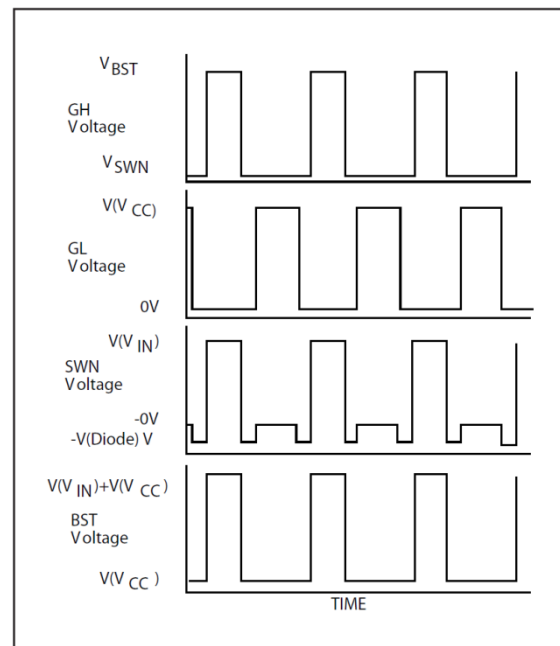

SETTING OUTPUT VOLTAGES

The SP7652 can be set to different output voltages. The relationship in the following formula is based on a voltage divider from the output to the feedback pin V_{FB} , which is set to an internal reference voltage of 0.80V.



6A 28V 600KHz Synchronous Step Down Regulator

Standard 1% metal film resistors of surface mount size 0603 are recommended.

$$V_{OUT} = 0.80V (R1/R2+1)$$
$$\Rightarrow R2 = \frac{R1}{\{(V_{OUT} / 0.8V) - 1\}}$$

Where R1 = 68.1kΩ and for V_{OUT} = 0.80V setting, simply remove R2 from the board.

APPLICATION INFORMATION

INDUCTOR SELECTION

There are many factors to consider in selecting the inductor including core material, inductance vs. frequency, current handling capability, efficiency, size and EMI. In a typical SP7652 circuit, the inductor is chosen primarily by operating frequency, saturation current and DC resistance. Increasing the inductor value will decrease output voltage ripple, but degrade transient response. Low inductor values provide the smallest size, but cause large ripple currents, poor efficiency and require more output capacitance to smooth out the larger ripple current. The inductor must be able to handle the peak current at the switching frequency without saturating, and the copper resistance in the winding should be kept as low as possible to minimize resistive power loss. A good compromise between size, loss and cost is to set the inductor ripple current to be within 20% to 40% of the maximum output current.

The switching frequency and the inductor operating point determine the inductor value as follows:

$$L = \frac{V_{OUT}(V_{IN(MAX)} - V_{OUT})}{V_{IN(MAX)}F_s \cdot K_R \cdot I_{OUT(MAX)}}$$

where:

F_s = switching frequency

K_R = ratio of the AC inductor ripple current to the maximum output current.

Furthermore, one could select the value of the R1 and R2 combination to meet the exact output voltage setting by restricting R1 resistance range such that 50kΩ < R1 < 100kΩ for overall system loop stability.

The peak to peak inductor ripple current is:

$$I_{PP} = \frac{V_{OUT} (V_{IN(MAX)} - V_{OUT})}{V_{IN(MAX)} \cdot F_s \cdot L}$$

Once the required inductor value is selected, the proper selection of core material is based on peak inductor current and efficiency requirements.

The core must be large enough not to saturate at the peak inductor current

$$I_{PEAK} = I_{OUT(MAX)} + \frac{I_{PP}}{2}$$

and provide low core loss at the high switching frequency. Low cost powdered-iron cores are inappropriate for 900kHz operation. Gapped ferrite inductors are widely available for consideration. Select devices that have operating data shown up to 1 MHz. Ferrite materials, on the other hand, are more expensive and have an abrupt saturation characteristic with the inductance dropping sharply when the peak design current is exceeded. Nevertheless, they are preferred at high switching frequencies because they present very low core loss and the design only needs to prevent saturation. In general, ferrite or molypermalloy materials are better choice for all but the most cost sensitive applications.

OPTIMIZING EFFICIENCY

The power dissipated in the inductor is equal to the sum of the core and copper losses. To minimize copper losses, the winding resistance needs to be minimized, but this usually comes at the expense of a larger inductor. Core losses have a more significant contribution at low output current where the copper losses are at a minimum, and can typically be



6A 28V 600KHz Synchronous Step Down Regulator

neglected at higher output currents where the copper losses dominate. Core loss information is usually available from the magnetics vendor. Proper inductor selection can affect the resulting power supply efficiency by more than 15-20%!

The copper loss in the inductor can be calculated

using the following equation:

$$P_{L(CU)} = I_{L(RMS)}^2 R_{WINDING}$$

where $I_{L(RMS)}$ is the RMS inductor current that can be calculated as follows:

$$I_{L(RMS)} = I_{OUT(MAX)} \sqrt{1 + \frac{1}{3} \left(\frac{I_{PP}}{I_{OUT(MAX)}} \right)^2}$$

OUTPUT CAPACITOR SELECTION

The required ESR (Equivalent Series Resistance) and capacitance drive the selection of the type and quantity of the output capacitors. The ESR must be small enough that both the resistive voltage deviation due to a step change in the load current and the output ripple voltage do not exceed the tolerance limits expected on the output voltage. During an output load transient, the output capacitor must supply all the additional current demanded by the load until the SP7652 adjusts the inductor current to the new value.

In order to maintain V_{OUT} , the capacitance must be large enough so that the output voltage is held up while the inductor current ramps up or down to the value corresponding to the new load current. Additionally, the ESR in the output capacitor causes a step in the output voltage equal to the current. Because of the fast transient response and inherent 100% to 0% duty cycle capability provided by the SP7652 when exposed to output load transient, the output capacitor is typically chosen for ESR, not for capacitance value.

The ESR of the output capacitor, combined with the inductor ripple current, is typically the main contributor to output voltage ripple. The maximum allowable ESR required to maintain a specified output voltage ripple can be calculated by:

$$R_{ESR} \leq \frac{\Delta V_{OUT}}{I_{PK-PK}}$$

where:

ΔV_{OUT} = Peak-to-Peak Output Voltage Ripple

I_{PK-PK} = Peak-to-Peak Inductor Current

The total output ripple is a combination of the ESR and the output capacitance value and can be calculated as follows:

$$\Delta V_{OUT} = \sqrt{\left(\frac{I_{PP}(1-D)}{C_{OUT}F_S} \right)^2 + (I_{PP}R_{ESR})^2}$$

F_S = Switching Frequency

D = Duty Cycle

C_{OUT} = Output Capacitance Value

INPUT CAPACITOR SELECTION

The input capacitor should be selected for ripple current rating, capacitance and voltage rating. The input capacitor must meet the ripple current requirement imposed by the switching current. In continuous conduction mode, the source current of the high-side MOSFET is approximately a square wave of duty cycle V_{OUT}/V_{IN} . Most of this current is supplied by the input bypass capacitors. The RMS value of input capacitor current is determined at the maximum output current and under the assumption that the peak to peak inductor ripple current is low; it is given by:

$$I_{CIN(RMS)} = I_{OUT(MAX)} \sqrt{D(1-D)}$$

The worse case occurs when the duty cycle D is 50% and gives an RMS current value equal to $I_{OUT}/2$.

Select input capacitors with adequate ripple current rating to ensure reliable operation.

The power dissipated in the input capacitor is:

$$P_{CIN} = I_{CIN(RMS)}^2 R_{ESR(CIN)}$$

This can become a significant part of power losses in a converter and hurt the overall energy transfer efficiency. The input voltage ripple primarily depends on the input capacitor ESR and capacitance. Ignoring the inductor

6A 28V 600KHz Synchronous Step Down Regulator

ripple current, the input voltage ripple can be determined by:

$$\Delta V_{IN} = I_{OUT(MAX)} R_{ESR(CIN)} + \frac{I_{OUT(MAX)} V_{OUT} (V_{IN} - V_{OUT})}{F_S C_{IN} V_{IN}^2}$$

The capacitor type suitable for the output capacitors can also be used for the input capacitors. However, exercise additional caution when tantalum capacitors are used. Tantalum capacitors are known for catastrophic failure when exposed to surge current, and input capacitors are prone to such surge current when power supplies are connected "live" to low impedance power sources.

LOOP COMPENSATION DESIGN

The open loop gain of the whole system can be divided into the gain of the error amplifier, PWM modulator, buck converter output stage, and feedback resistor divider. In order to cross over at the selected frequency f_{CO} , the gain of the error amplifier compensates for the attenuation caused by the rest of the loop at this frequency.

The goal of loop compensation is to manipulate loop frequency response such that its gain crosses over 0db at a slope of -20db/dec. The first step of compensation design is to pick the loop crossover frequency.

High crossover frequency is desirable for fast transient response, but often jeopardizes the system stability. Crossover frequency should be higher than the ESR zero but less than 1/5 of the switching frequency. The ESR zero is contributed by the ESR associated with the output capacitors and can be determined by:

$$f_{Z(ESR)} = \frac{1}{2\pi C_{OUT} R_{ESR}}$$

The next step is to calculate the complex conjugate poles contributed by the LC output filter,

$$f_{P(LC)} = \frac{1}{2\pi \sqrt{L C_{OUT}}}$$

When the output capacitors are of a Ceramic Type, the SP7652 Evaluation Board requires a Type III compensation circuit to give a phase boost of 180° in order to counteract the effects of an underdamped resonance of the output filter at the double pole frequency

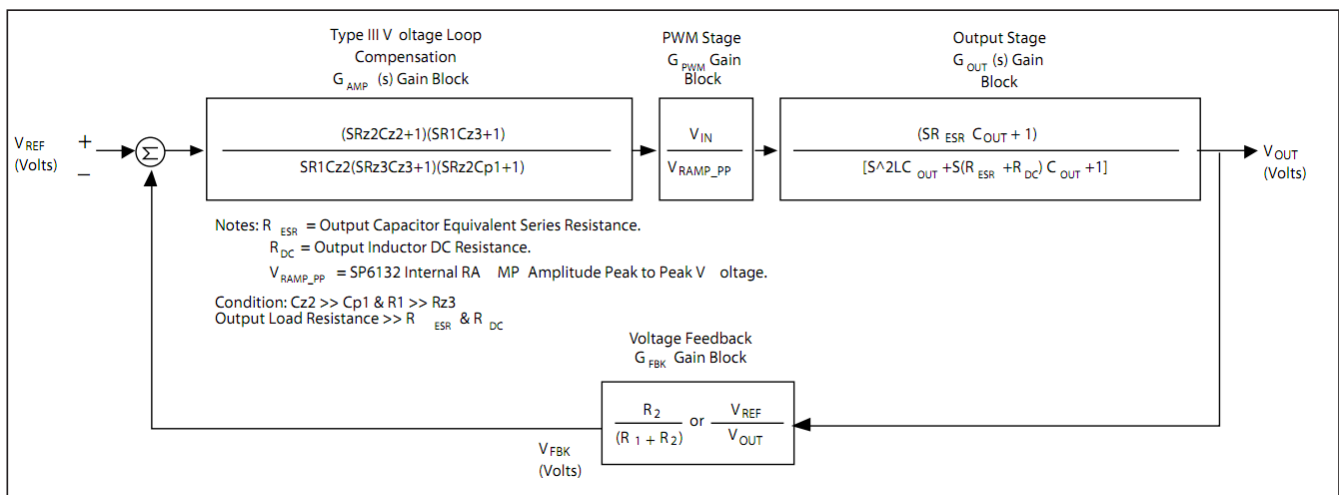

Fig. 12: SP7652 Voltage Mode Control Loop

Definitions:

R_{ESR} = Output Capacitor Equivalent Series Resistance

R_{DC} = Output Inductor DC Resistance

R_{RAMP_PP} = SP7652 internal Ramp Amplitude Peak to Peak Voltage

Conditions:

$C_{Z2} \gg C_{p1}$ and $R1 \gg R_{Z3}$

Output Load Resistance \gg RESR and RDC

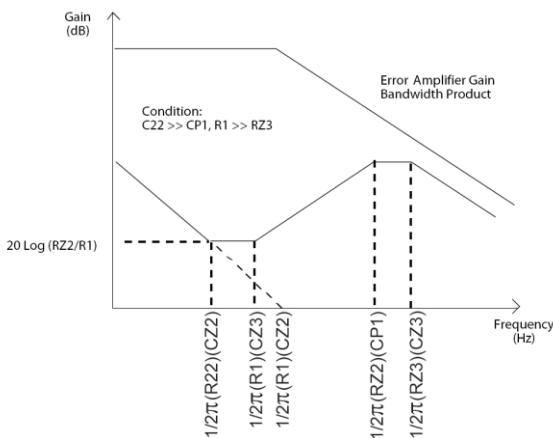

Fig. 13: Bode Plot of Type III Error Amplifier Compensation

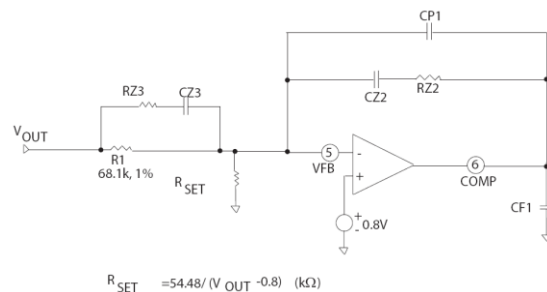

Fig. 14: Type III Error Amplifier Compensation Circuit

SP765X THERMAL RESISTANCE

The SP765X family has been tested with a variety of footprint layouts along with different copper area and thermal resistance has been measured. The layouts were done on 4 layer FR4 PCB with the top and bottom layers using 3oz copper and the power and ground layers using 1oz copper.

For the Minimum footprint, only about 0.1 square inch (of 3 ounces of) Copper was used on the top or footprint layer, and this layer had no vias to connect to the 3 other layers. For the Medium footprint, about 0.7 square inches (of 3 ounces of) Copper was used on the top layer, but vias were used to connect to the other 3 layers. For the Maximum footprint, about .0 square inch (of 3 ounces of) Copper was used on the top layer and many vias were used to connect to the 3 other layers.

The results show that only about 0.7 square inches (of 3 ounces of) Copper on the top layer and vias connecting to the 3 other layers are needed to get the best thermal resistance of 36°C/W. Adding area on the top beyond the 0.7 square inches did not reduce thermal resistance.

Using a minimum of 0.1 square inches (3 ounces of) Copper on the top layer with no vias connecting to the 3 other layers produced a thermal resistance of 44°C/W. This thermal impedance is only 22% higher than the medium and large footprint layouts, indicating that space constrained designs can still benefit thermally from the Powerblox family of ICs. This indicates that a minimum footprint of 0.1 square inch, if used on a 4 layer board, can produce 44°C/W thermal resistance. This approach is still very worthwhile if used in a space constrained design.

6A 28V 600KHz Synchronous Step Down Regulator

The following figures show the footprint layouts from an ORCAD file. The thermal data was taken for still air, not with forced air. If forced air is used, some improvement in thermal resistance would be seen.

SP765X THERMAL RESISTANCE

4 Layer Board:

- Top Layer 3ounces Copper
- GND Layer 1ounce Copper
- Power Layer ounce Copper
- Bottom Layer 3ounces Copper

Minimum Footprint: 44°C/W

Top Layer: 0.1 square inch
No Vias to other 3 Layers

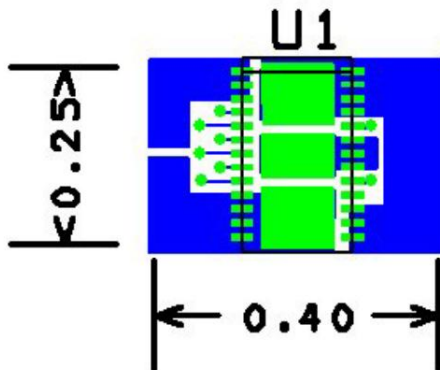

Fig. 15: Minimum Footprint = 0.10in²

Medium Footprint: 36°C/W

Top Layer: 0.7 square inch
Vias to other 3 Layers

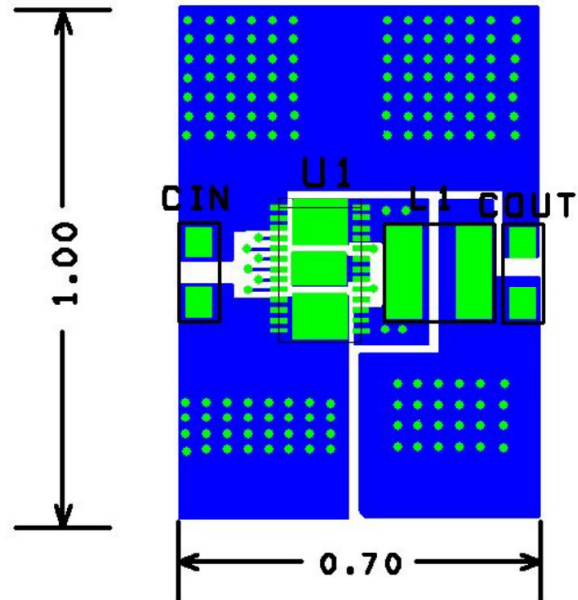

Fig. 16: Medium Footprint = 0.70in²

Maximum Footprint: 36°C/W

Top Layer: .0 square inch
Vias to other 3 Layers

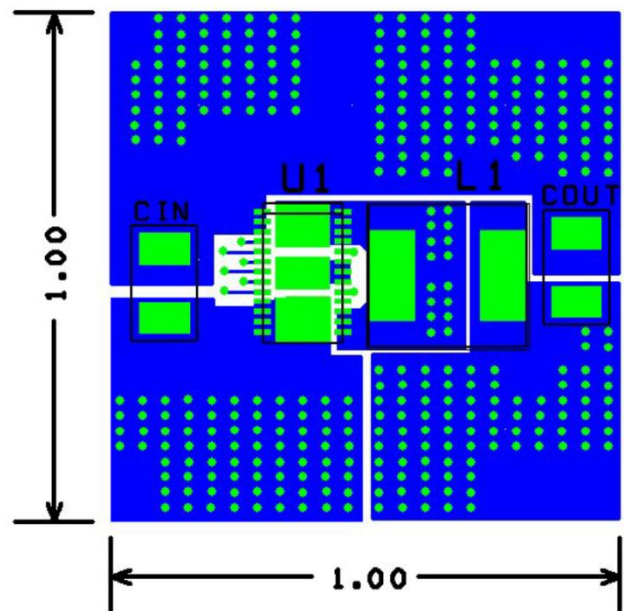

Fig. 17: Maximum Footprint = 1.0in²



SP7652 Powerblox™ 6A 28V 600KHz Synchronous Step Down Regulator

PACKAGE SPECIFICATION

26 PIN DFN

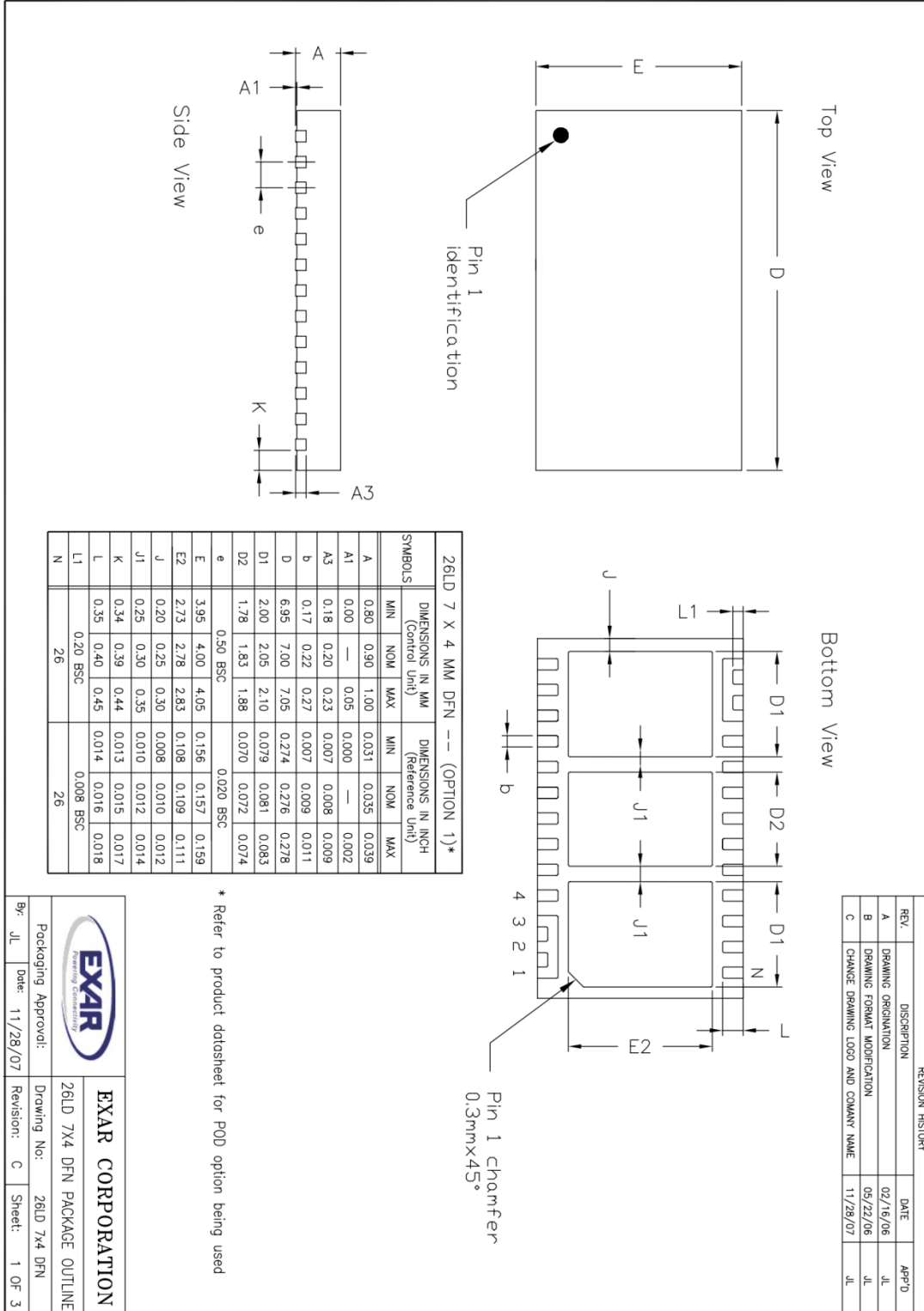



REVISION HISTORY

Revision	Date	Description
2.0.0	07/15/16/2012	Reformat of Datasheet

FOR FURTHER ASSISTANCE

Email:

customersupport@exar.com

Exar Technical Documentation:

<http://www.exar.com/TechDoc/default.aspx?>

EXAR CORPORATION

HEADQUARTERS AND SALES OFFICES

48720 Kato Road

Fremont, CA 94538 – USA

Tel.: +1 (510) 668-7000

Fax: +1 (510) 668-7030

www.exar.com



NOTICE

EXAR Corporation reserves the right to make changes to the products contained in this publication in order to improve design, performance or reliability. EXAR Corporation assumes no responsibility for the use of any circuits described herein, conveys no license under any patent or other right, and makes no representation that the circuits are free of patent infringement. Charts and schedules contained here in are only for illustration purposes and may vary depending upon a user's specific application. While the information in this publication has been carefully checked; no responsibility, however, is assumed for inaccuracies.

EXAR Corporation does not recommend the use of any of its products in life support applications where the failure or malfunction of the product can reasonably be expected to cause failure of the life support system or to significantly affect its safety or effectiveness. Products are not authorized for use in such applications unless EXAR Corporation receives, in writing, assurances to its satisfaction that: (a) the risk of injury or damage has been minimized; (b) the user assumes all such risks; (c) potential liability of EXAR Corporation is adequately protected under the circumstances.

Reproduction, in part or whole, without the prior written consent of EXAR Corporation is prohibited.



Компания «ЭлектроПласт» предлагает заключение долгосрочных отношений при поставках импортных электронных компонентов на взаимовыгодных условиях!

Наши преимущества:

- Оперативные поставки широкого спектра электронных компонентов отечественного и импортного производства напрямую от производителей и с крупнейших мировых складов;
- Поставка более 17-ти миллионов наименований электронных компонентов;
- Поставка сложных, дефицитных, либо снятых с производства позиций;
- Оперативные сроки поставки под заказ (от 5 рабочих дней);
- Экспресс доставка в любую точку России;
- Техническая поддержка проекта, помощь в подборе аналогов, поставка прототипов;
- Система менеджмента качества сертифицирована по Международному стандарту ISO 9001;
- Лицензия ФСБ на осуществление работ с использованием сведений, составляющих государственную тайну;
- Поставка специализированных компонентов (Xilinx, Altera, Analog Devices, Intersil, Interpoint, Microsemi, Aeroflex, Peregrine, Syfer, Eurofarad, Texas Instrument, Miteq, Cobham, E2V, MA-COM, Hittite, Mini-Circuits, General Dynamics и др.);

Помимо этого, одним из направлений компании «ЭлектроПласт» является направление «Источники питания». Мы предлагаем Вам помощь Конструкторского отдела:

- Подбор оптимального решения, техническое обоснование при выборе компонента;
- Подбор аналогов;
- Консультации по применению компонента;
- Поставка образцов и прототипов;
- Техническая поддержка проекта;
- Защита от снятия компонента с производства.



Как с нами связаться

Телефон: 8 (812) 309 58 32 (многоканальный)

Факс: 8 (812) 320-02-42

Электронная почта: org@eplast1.ru

Адрес: 198099, г. Санкт-Петербург, ул. Калинина, дом 2, корпус 4, литера А.