

Distinctive Characteristics

Top or side actuation permits flexible board design.

Bright, LED illumination at tip of actuator.

Compact dimensions and low profile allow high density mounting and close stacking of PC boards.

Crisp actuation positively indicates circuit status.

Double molded thermoset base and thermoplastic housing prevent loosening of terminals due to high soldering temperatures.

Sliding twin contact mechanism with self-cleaning action provides smooth actuation and produces high contact reliability.

Insert molded terminals lock out flux, solvents, and other contaminants.

Inch terminal spacing for standard PC board grid (.100" x .100").

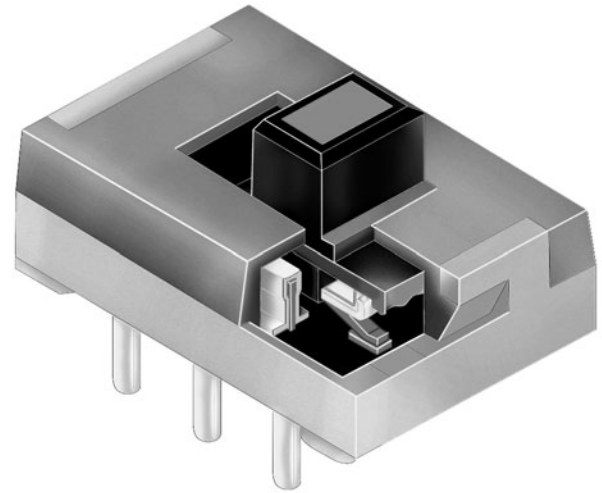

Actual Size

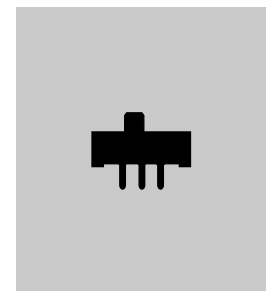

General Specifications

Electrical Capacity (Resistive Load)

Power Level: 0.1A @ 30V DC

Other Ratings

Contact Resistance:	20 milliohms maximum
Insulation Resistance:	100 megohms minimum @ 500V DC
Dielectric Strength:	500V AC minimum 1 minute minimum
Mechanical Life:	10,000 operations minimum
Electrical Life:	10,000 operations minimum
Contact Timing:	Shorting (make-before-break)
Total Travel:	.079" (2.0mm)

Materials & Finishes

Actuator:	Polyacetal
Upper Case:	Polyacetal
Lower Case:	Glass fiber reinforced polyester
Movable Contactor:	Phosphor bronze with silver plating
Interior Base:	Phenolic resin (thermoset)
Terminals:	Brass with silver plating over copper plating

Environmental Data

Operating Temp Range:	-15°C through +60°C (+5°F through +140°F)
Humidity:	90 ~ 95% humidity for 96 hours @ 40°C (104°F)
Vibration:	10 ~ 55Hz with peak-to-peak amplitude of 1.5mm traversing the frequency range & returning in 1 minute; 3 right angled directions for 2 hours
Shock:	50G (490m/s ²) acceleration (tested in 6 right angled directions, with 5 shocks in each direction)

PCB Processing

Soldering:	Wave Soldering: For non-supported through-hole, see Profile B in Supplement section. For supported through-hole, 5 seconds maximum @ 250°C maximum. Manual Soldering: See Profile B in Supplement section.
Cleaning:	These devices are not process sealed. Hand clean locally using alcohol based solution.

Standards & Certifications

The SS series devices have not been tested for UL recognition and CSA certification. These switches are designed for use in a low-voltage, low-current circuit. When used as intended in a low-voltage, low-current circuit, the results do not produce hazardous energy.

TYPICAL SWITCH ORDERING EXAMPLE

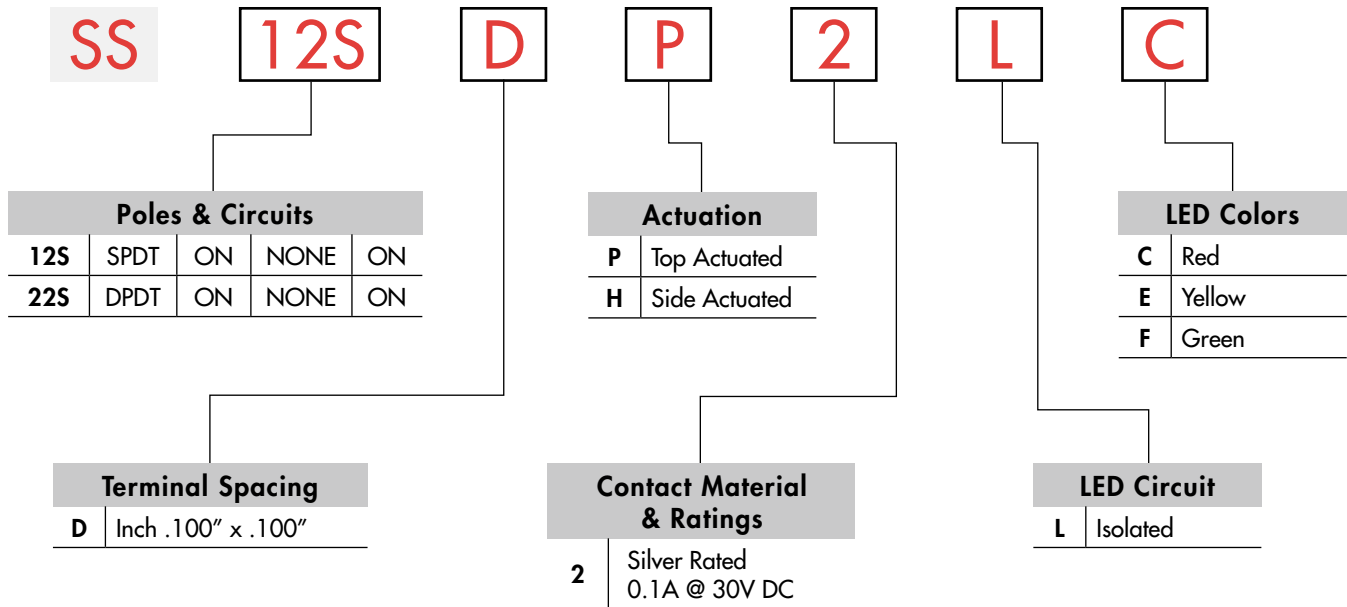

DESCRIPTION FOR TYPICAL ORDERING EXAMPLE

SS12SDP2LC

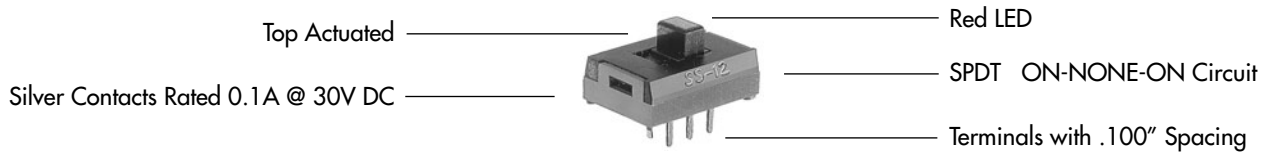

POLES & CIRCUITS

Pole	Model	Slide Position			Connected Terminals			Throw & Schematics
		Right	Center	Left	Right	Center	Left	
SP	SS12S	ON	NONE	ON	2-1	NONE	2-3	SPDT
DP	SS22S	ON	NONE	ON	2-1 5-4	NONE	2-3 5-6	DPDT

Note: Terminal numbers are not actually on switch. Isolated LED circuit requires external power source.

TERMINAL SPACING

D Inch .100" x .100"

Single Pole Models

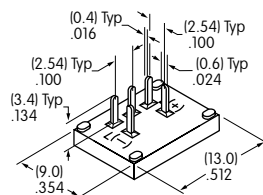

Double Pole Models

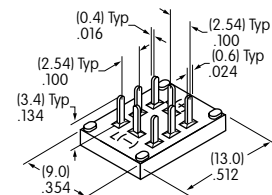

CONTACT MATERIALS & RATINGS

2

Silver over Phosphor Bronze

Power Level

0.1A @ 30V DC

TYPICAL SWITCH DIMENSIONS

Single & Double Pole

Top Actuated

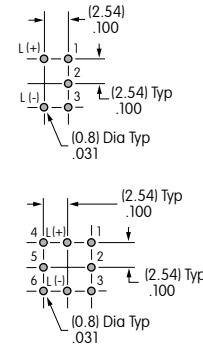
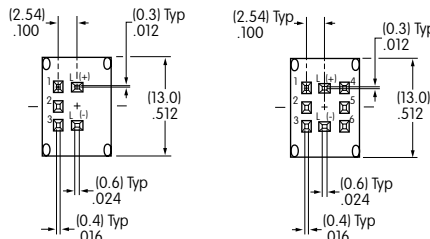
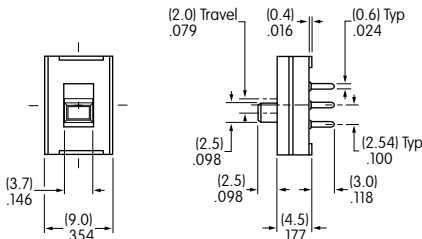

SS22SDP2LC

Single & Double Pole

Side Actuated

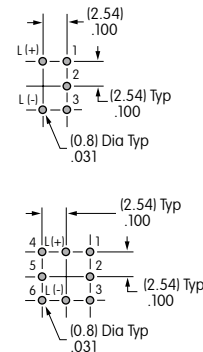
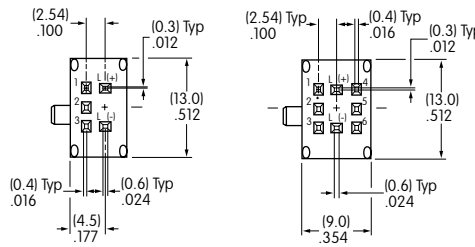
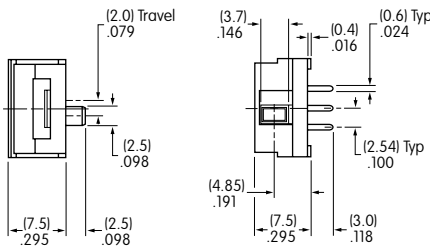

SS12SDH2LC

LED COLORS & SPECIFICATIONS

LEDs are supplied as an integral part of the switch (not available separately). The lamp circuit is independent of switch operation. Electrical specifications shown are determined at a basic temperature of 25°C. If the source voltage exceeds the rated voltage, a ballast resistor is required. The resistor value can be calculated by using the formula given in the Supplement.

<div style="border: 1px solid black; padding: 2px;">L</div> Isolated, 1-element		Color	<div style="border: 1px solid black; padding: 2px;">C</div> Red	<div style="border: 1px solid black; padding: 2px;">E</div> Yellow	<div style="border: 1px solid black; padding: 2px;">F</div> Green
			Forward Peak Current	I_{FM}	30mA
Typical Forward Current	I_F	16mA	16mA	16mA	
Forward Voltage	V_F	1.98V	2.06V	2.16V	
Reverse Peak Voltage	V_{RM}	5V	5V	5V	
Current Reduction Rate Above 25°C	ΔI_F	0.40mA/°C	0.42mA/°C	0.33mA/°C	
Ambient Temperature Range		-15° ~ +60°C			

OPTIONAL CAP

AT4065 Slide Cap

Material: Polycarbonate

Cap can be assembled on request

Cap Color: Black only

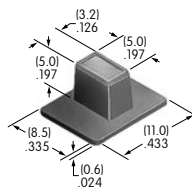

Window color should match LED color.

Colors Available:

C Red E Yellow F Green

Toggles
 Rockers
 Pushbuttons
 Illuminated PB
 Programmable
 Keylocks
 Rotaries
 Slides
 Tactiles
 Tilt
 Touch
 Indicators
 Accessories
 Supplement



Компания «ЭлектроПласт» предлагает заключение долгосрочных отношений при поставках импортных электронных компонентов на взаимовыгодных условиях!

Наши преимущества:

- Оперативные поставки широкого спектра электронных компонентов отечественного и импортного производства напрямую от производителей и с крупнейших мировых складов;
- Поставка более 17-ти миллионов наименований электронных компонентов;
- Поставка сложных, дефицитных, либо снятых с производства позиций;
- Оперативные сроки поставки под заказ (от 5 рабочих дней);
- Экспресс доставка в любую точку России;
- Техническая поддержка проекта, помощь в подборе аналогов, поставка прототипов;
- Система менеджмента качества сертифицирована по Международному стандарту ISO 9001;
- Лицензия ФСБ на осуществление работ с использованием сведений, составляющих государственную тайну;
- Поставка специализированных компонентов (Xilinx, Altera, Analog Devices, Intersil, Interpoint, Microsemi, Aeroflex, Peregrine, Syfer, Eurofarad, Texas Instrument, Miteq, Cobham, E2V, MA-COM, Hittite, Mini-Circuits, General Dynamics и др.);

Помимо этого, одним из направлений компании «ЭлектроПласт» является направление «Источники питания». Мы предлагаем Вам помощь Конструкторского отдела:

- Подбор оптимального решения, техническое обоснование при выборе компонента;
- Подбор аналогов;
- Консультации по применению компонента;
- Поставка образцов и прототипов;
- Техническая поддержка проекта;
- Защита от снятия компонента с производства.



Как с нами связаться

Телефон: 8 (812) 309 58 32 (многоканальный)

Факс: 8 (812) 320-02-42

Электронная почта: org@eplast1.ru

Адрес: 198099, г. Санкт-Петербург, ул. Калинина, дом 2, корпус 4, литера А.