



SANYO Semiconductors

# DATA SHEET

An ON Semiconductor Company

## LA4815VH — Monolithic Linear IC Monaural Power Amplifier

### Overview

The LA4815VH incorporates a 1-channel power amplifier with a wide operating supply voltage range built into a surface-mounted package. This IC also has a mute function and requires only a few external components, making it suitable for low-cost set design. There is also a MFP8 package type which incorporates the same chip (LA4815M).

### Applications

Intercoms, door phones, transceivers, radios, toys, home appliances with voice guidance, etc.

### Features

- Built-in 1-channel power amplifier
  - Output power 1 = 1.84W typ. ( $V_{CC} = 12V$ ,  $R_L = 8\Omega$ , THD = 10%)
  - Output power 2 = 1.55W typ. ( $V_{CC} = 9V$ ,  $R_L = 4\Omega$ , THD = 10%)
  - Output power 3 = 0.36W typ. ( $V_{CC} = 6V$ ,  $R_L = 8\Omega$ , THD = 10%)
  - Output power 4 = 0.23W typ. ( $V_{CC} = 5V$ ,  $R_L = 8\Omega$ , THD = 10%)
- Mute function
- Selectable voltage gain : 2 types
  - 26dB/40dB
  - \* Gain values between 26 and 40dB can also be set by adding external components (two resistors).
- Only a few external components
  - 4 components/total
- Wide supply voltage range
  - 4 to 16V

■ Any and all SANYO Semiconductor Co.,Ltd. products described or contained herein are, with regard to "standard application", intended for the use as general electronics equipment (home appliances, AV equipment, communication device, office equipment, industrial equipment etc.). The products mentioned herein shall not be intended for use for any "special application" (medical equipment whose purpose is to sustain life, aerospace instrument, nuclear control device, burning appliances, transportation machine, traffic signal system, safety equipment etc.) that shall require extremely high level of reliability and can directly threaten human lives in case of failure or malfunction of the product or may cause harm to human bodies, nor shall they grant any guarantee thereof. If you should intend to use our products for applications outside the standard applications of our customer who is considering such use and/or outside the scope of our intended standard applications, please consult with us prior to the intended use. If there is no consultation or inquiry before the intended use, our customer shall be solely responsible for the use.

■ Specifications of any and all SANYO Semiconductor Co.,Ltd. products described or contained herein stipulate the performance, characteristics, and functions of the described products in the independent state, and are not guarantees of the performance, characteristics, and functions of the described products as mounted in the customer's products or equipment. To verify symptoms and states that cannot be evaluated in an independent device, the customer should always evaluate and test devices mounted in the customer's products or equipment.

# LA4815VH

## Specifications

### Maximum Ratings at $T_a = 25^\circ\text{C}$

| Parameter                    | Symbol       | Conditions             | Ratings     | Unit             |
|------------------------------|--------------|------------------------|-------------|------------------|
| Maximum power supply voltage | $V_{CC}$ max |                        | 18          | V                |
| Allowable power dissipation  | $P_d$ max    | * Mounted on the board | 1.5         | W                |
| Operating temperature        | $T_{opr}$    |                        | -30 to +75  | $^\circ\text{C}$ |
| Storage temperature          | $T_{stg}$    |                        | -40 to +150 | $^\circ\text{C}$ |

\* Mounted on SANYO evaluation board : Double-sided board with dimensions of 50mm  $\times$  50mm  $\times$  1.6mm (glass epoxy)

### Operating Conditions at $T_a = 25^\circ\text{C}$

| Parameter                                | Symbol      | Conditions | Ratings | Unit     |
|--|-------------|------------|---------|----------|
| Recommended power supply voltage         | $V_{CC}$    |            | 12      | V        |
| Recommended load resistance              | $R_L$       |            | 4 to 32 | $\Omega$ |
| Allowable operating supply voltage range | $V_{CC}$ op |            | 4 to 16 | V        |

\* The supply voltage level to be used must be determined with due consideration given to the allowable power dissipation of the IC.

### Electrical Characteristics at $T_a = 25^\circ\text{C}$ , $V_{CC} = 12\text{V}$ , $R_L = 8\Omega$ , $f_{in} = 1\text{kHz}$

| Parameter                  | Symbol      | Conditions   | Ratings |       |      | Unit                |
|----------------------------|-------------|--|---------|-------|------|---------------------|
|                            |             |  | min     | typ   | max  |                     |
| Quiescent current drain-1  | $I_{CCOP1}$ | No signal  |         | 5.3   | 9.5  | mA                  |
| Quiescent current drain-2  | $I_{CCOP2}$ | No signal, pin 3 = LOW   |         | 2.4   |      | mA                  |
| Maximum output power-1     | POMAX1      | THD = 10%  | 1.2     | 1.84  |      | W                   |
| Maximum output power-2     | POMAX2      | THD = 10%, $V_{CC} = 9\text{V}$ , $R_L = 4\Omega$                |         | 1.55  |      | W                   |
| Voltage gain-1             | VG1         | $V_{IN} = -30\text{dBV}$   | 23.9    | 25.9  | 27.9 | dB                  |
| Voltage gain-2             | VG2         | $V_{IN} = -40\text{dBV}$ , pin 4/pin11 = GND                     | 37      | 39.5  | 42   | dB                  |
| Total harmonic distortion  | THD         | $V_{IN} = -30\text{dBV}$   |         | 0.125 | 0.7  | %                   |
| Mute attenuation           | MT          | $V_{IN} = -10\text{dBV}$ , pin 3 = LOW                           | -90     | -115  |      | dBV                 |
| Output noise voltage       | $V_{NOUT}$  | $R_g = 620\Omega$ , 20 to 20kHz                                  |         | 40    | 100  | $\mu\text{V}_{rms}$ |
| Ripple rejection ratio     | SVRR        | $R_g = 620\Omega$ , $f_r = 100\text{Hz}$ , $V_r = -20\text{dBV}$ |         | 44    |      | dB                  |
| Mute control voltage-LOW   | V3cntL      | Mute mode  |         |       | 0.3  | V                   |
| Mute control voltage-HIGH1 | V3cntH1     | Mute released, $V_{CC} = 6.5\text{V}$ or lower                   | 1.8     |       |      | V                   |
| Mute control voltage-HIGH2 | V3cntH2     | Mute released, $V_{CC} = 6.5\text{V}$ or higher                  | 2.4     |       |      | V                   |
| Input resistance           | $R_i$       |  |         | 100   |      | $\text{k}\Omega$    |

**Package Dimensions**

unit : mm (typ)  
3313

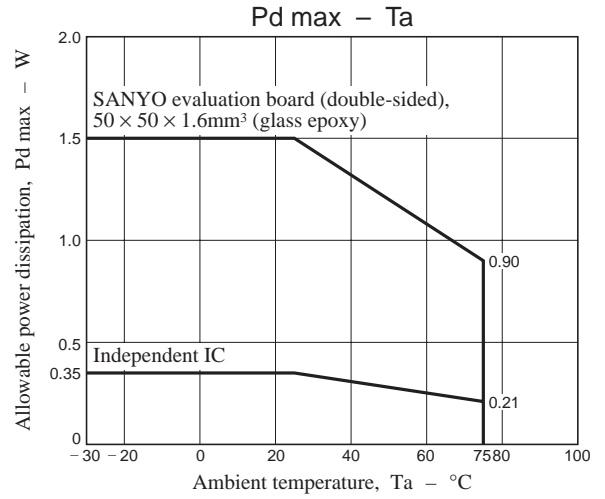
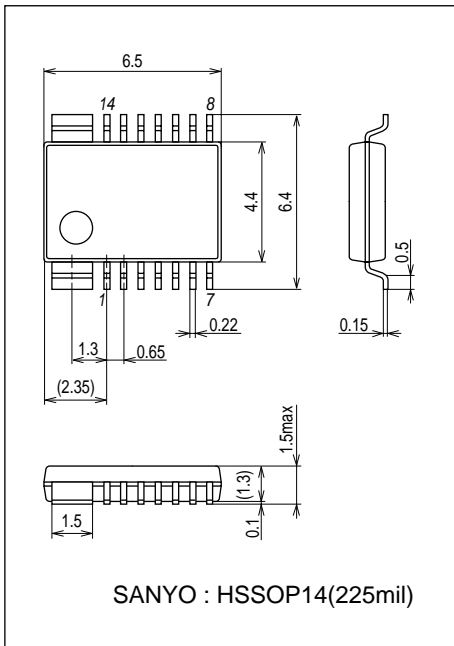

**Evaluation board**

1. Double-sided circuit board  
Dimensions : 50mm × 50mm × 1.6mm  
Top Layer (Top view)

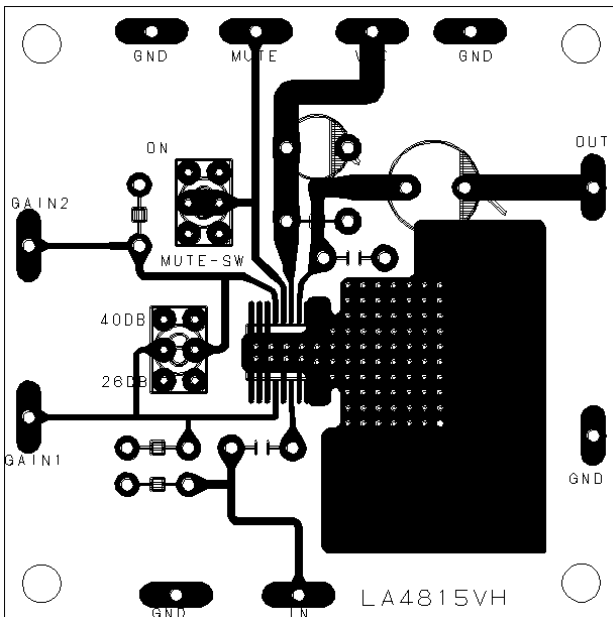

Bottom Layer (Top view)

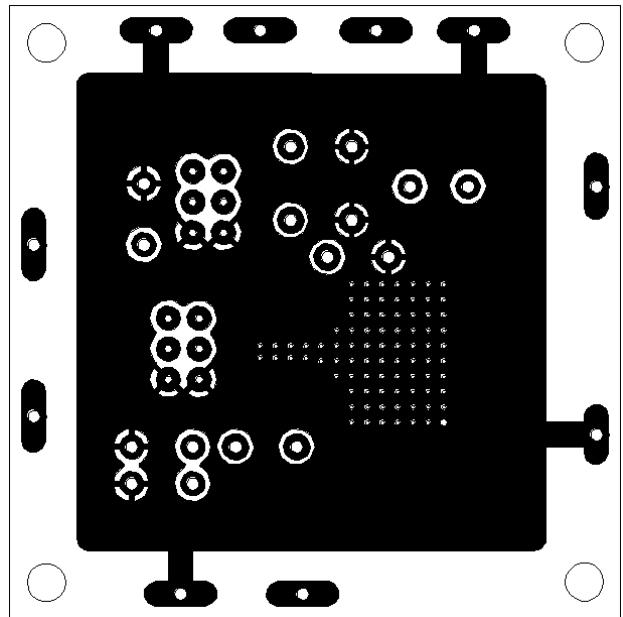

# LA4815VH

## Block Diagram and Sample Application Circuit

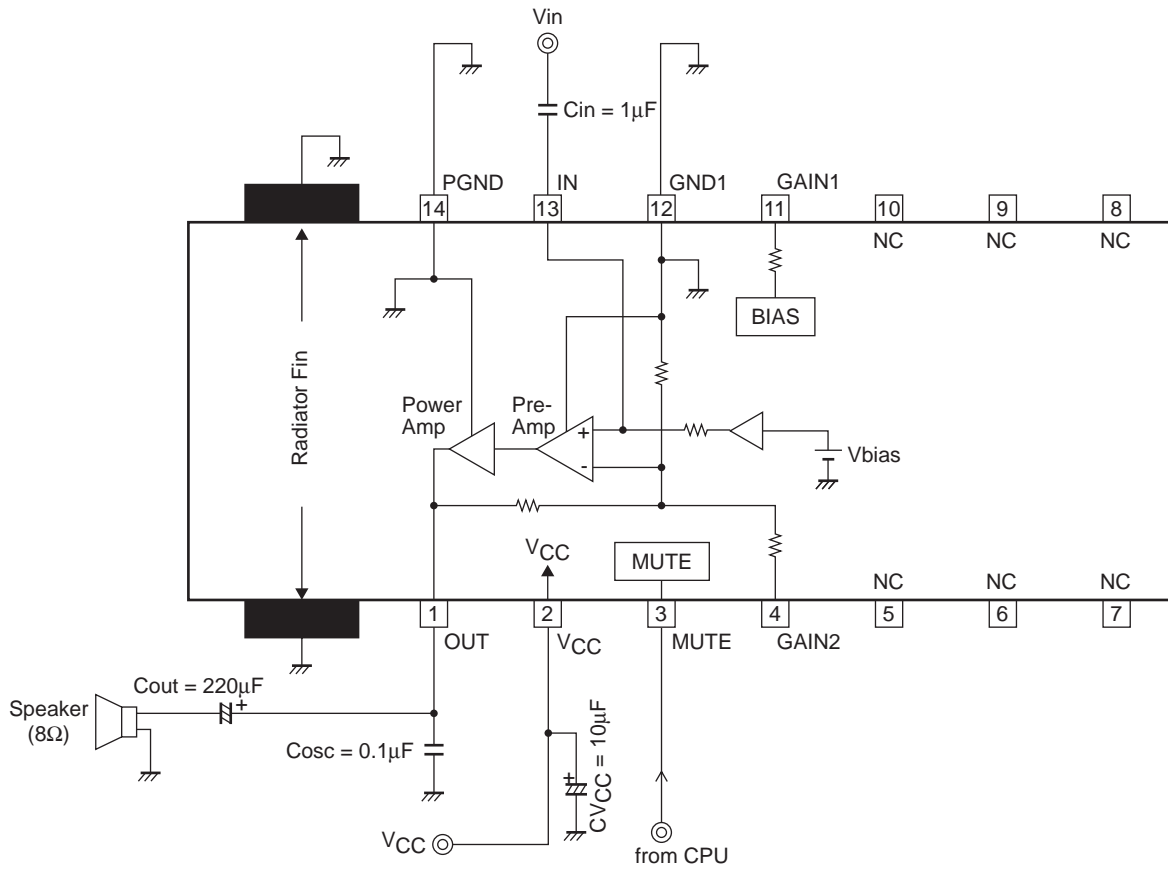

## Test Circuit

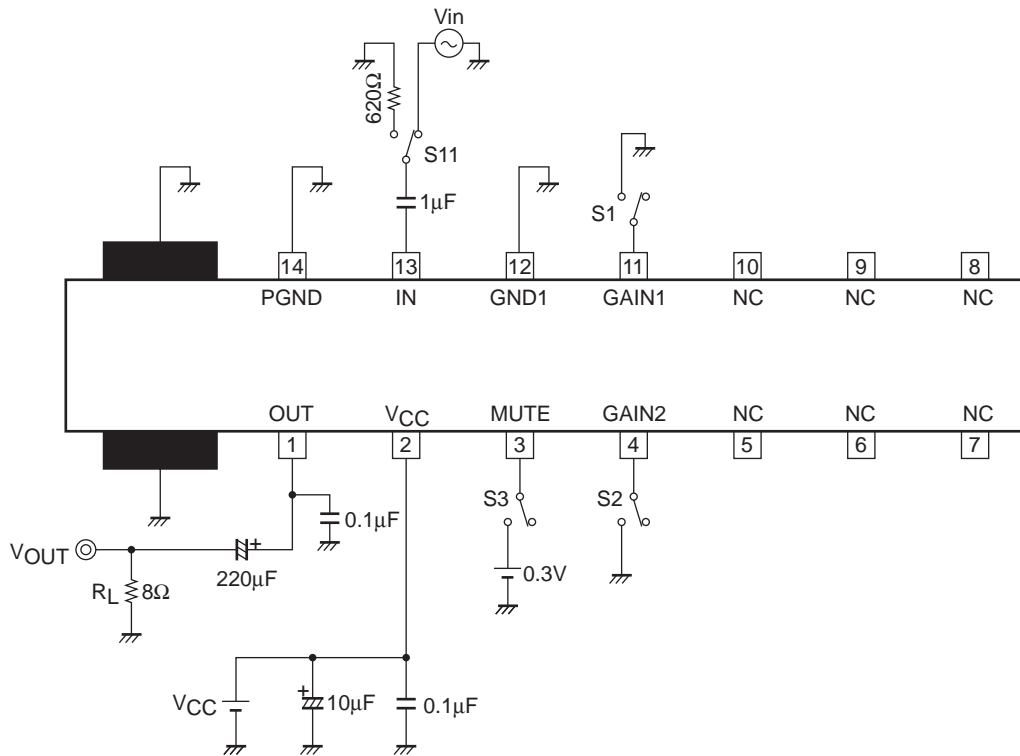

# LA4815VH

## Pin Functions

| Pin No. | Pin Name | Pin Voltage    | Description   | Equivalent Circuit |
|---------|----------|----------------|---|--------------------|
|         |          | $V_{CC} = 12V$ |   |                    |
| 11      | GAIN1    | 0.35           | Gain switching pin.<br><ul style="list-style-type: none"> <li>• 26dB mode when left open.</li> <li>• 40dB mode when connected to ground.</li> </ul> (Both pins 11 and 4 must be reconfigured at the same time.) |                    |
| 12      | GND1     | 0              | Preamplifier system ground pin.   |                    |
| 13      | IN       | 1.7            | Input pin.  |                    |
| 14      | PGND     | 0              | Power amplifier ground pin.   |                    |
| 1       | OUT      | 5.9            | Power amplifier output pin.   |                    |
| 2       | $V_{CC}$ | 12             | Power supply pin.   |                    |
| 3       | MUTE     | 4.9            | Mute control pin.<br><ul style="list-style-type: none"> <li>• Mute ON <math>\Rightarrow</math> Low</li> <li>• Mute OFF <math>\Rightarrow</math> High</li> </ul>   |                    |
| 4       | GAIN2    | 0.35           | Gain switching pin.<br><ul style="list-style-type: none"> <li>• 26dB mode when left open.</li> <li>• 40dB mode when connected to ground.</li> </ul> (Both pins 11 and 4 must be reconfigured at the same time.) |                    |

## Notes on Using the IC

### 1. Voltage gain settings (Pins 4 and 11)

The voltage gain of the power amplifier is fixed by the internal resistors.

- Pins 4 and 11 be left open : Approximately 26dB
- Pins 4 and 11 connected to GND : Approximately 39.5dB

Note that the voltage gain can be changed using two resistors. (See Fig. 1)

- Voltage gain setting : According to the resistor connected between Pin 4 and Pin 12 (GND1)
  - \* Voltage gain =  $20\log(20 \times (625 + R_{vg1}) / (125 + R_{vg1}))$
- Output DC voltage setting : According to the resistor connected between Pin 11 and Pin 12 (GND1)
  - \*  $R_{vg1} = R_{vg2}$  must be satisfied.

In addition, the voltage gain can also be lowered to approximately 20dB (when using 5V or 6V power supply) by an application such as shown in Fig. 2 below.

- Voltage gain setting : According to the resistor connected between Pin 4 and Pin 1 (OUT)
  - \* Voltage gain =  $20\log(20 \times (125 + R_{vg3}) / (10,125 + R_{vg3}))$
- Output DC voltage setting : According to the resistor connected between Pin 11 and Pin 2 (V<sub>CC</sub>)
  - \* Set the resistor values so that the Pin 5 (OUT) DC voltage is approximately half the supply voltage.

Example : When  $R_{vg3} = 10k\Omega$ ,  $R_{vg4} = 22k\Omega$  (when  $V_{CC} = 6V$ )

However, note that using this method to greatly lower the voltage gain deteriorates the characteristics, so the voltage gain should be lowered only to approximately 20dB. In addition, when using a high supply voltage (7V or more), the clipped waveform may invert, so this voltage gain reduction method must not be used in these cases.

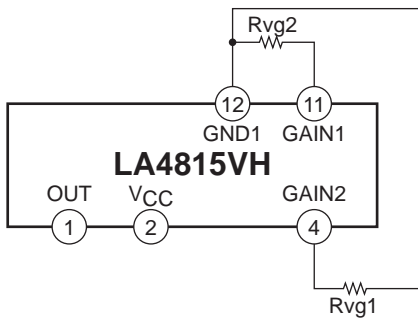

Figure 1

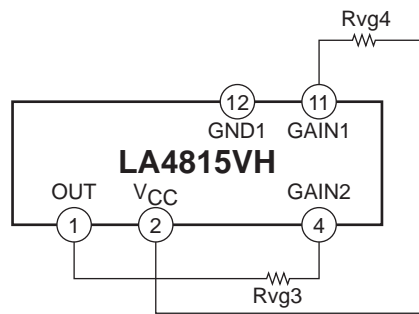

Figure 2

### 2. Signal source impedance : rg

As mentioned above, since the input coupling capacitor  $C_{in}$  affects the ripple rejection ratio, the signal source impedance value  $r_g$ , which is associated with this capacitor, also affects the ripple rejection ratio, so  $r_g$  should be as small as possible. Therefore, when attenuating the signal at the  $C_{in}$  front end as shown in Fig. 4, the constants should be set in consideration of these characteristics. Using the smallest resistor  $R_{g1}$  value possible is recommended.

In addition, when setting the signal level, the voltage gain should be set on the LA4815VH side and the input front-end should be configured using only the input coupling capacitor,  $C_{in}$ , as shown in Fig. 5 in order to maximize the ripple rejection ratio.

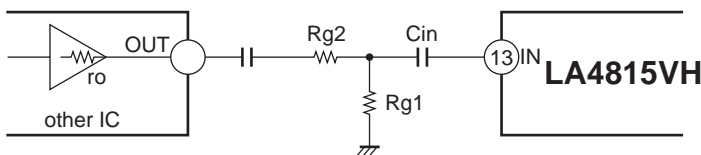

Figure 4

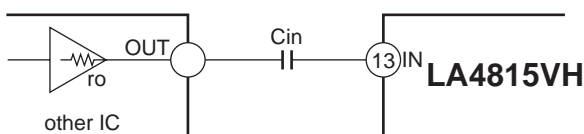

Figure 5

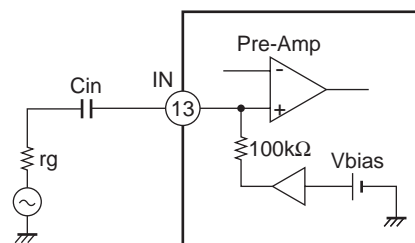

Figure 3

# LA4815VH

### 3. Mute control pin (Pin 3)

The internal power amplifier circuit can be disabled and audio mute is turned on by controlling the voltage applied to Pin 3. Control can be performed directly using the CPU output port, but digital noise from the CPU may worsen the LA4815VH noise floor. Therefore, inserting a series resistor, Rm1 (1 to 2.2kΩ) as shown in Fig. 6, is recommended.

- Mute ON : Low
- Mute OFF : High or open

In addition, the Pin 3 DC voltage is dependent on the supply voltage, so a reverse current flows to the CPU power supply line when the Pin 3 voltage is higher than the CPU supply voltage. In these cases, connect a resistor, Rm2 (see Fig. 7) between Pin 3 and GND to lower the Pin 3 DC voltage as shown in Fig. 6.

Note that when not using the mute function, Pin 3 must be left open.

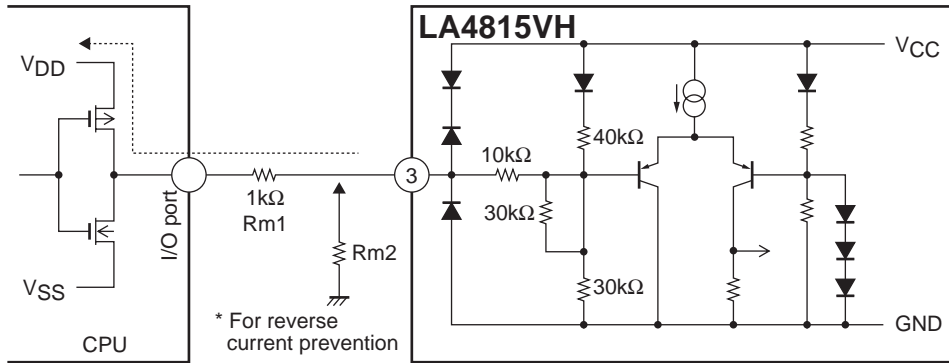

Figure 6

Reverse current prevention resistor value : Rm2 (reference value) ← When V3 is set to approximately 2.5V

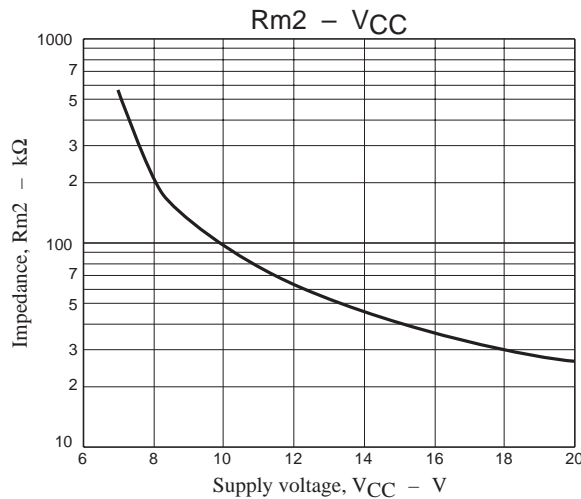

Figure 7

### 4. Mute control timing

When performing mute control, exercise control at the timing shown in Fig. 8.

During power-on : Twu = 0 to 50ms

\* Pins 2 and 3 can also rise simultaneously.

During power-off : Twd = 100 to 200ms

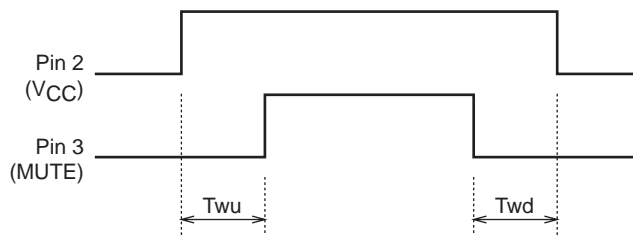

Figure 8

## LA4815VH

### 5. Popping noise reduction during power-off

The power supply line can be directly controlled ON and OFF without using the mute function. However, when using a high supply voltage, the shock noise and aftersound during power-off tends to worsen. One method of coping with this is to connect a capacitor between Pin 2 (V<sub>CC</sub>) and Pin 3 (MUTE) so that the auto mute function operates during power-off.

Recommended value = 1μF

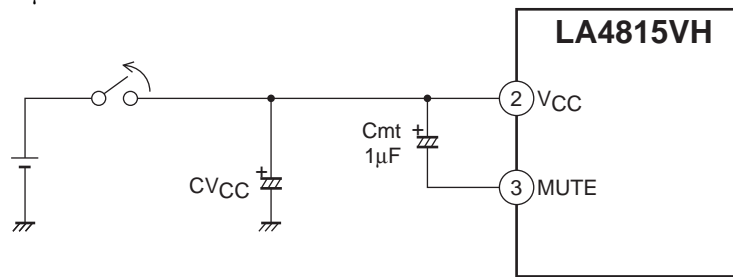

Figure 9

### 6. Input coupling capacitor (C<sub>in</sub>)

C<sub>in</sub> is an input coupling capacitor, and is used for DC cutting. However, this capacitor is also used to improve the ripple rejection ratio, which changes according to the capacitance value (recommended value = 1μF). In addition, this capacitor also affects the transient response characteristics during power-on and when mute is canceled, so the constant should be set in consideration of these characteristics.

Design reference value = approximately 0.33 to 3.3μF

- Ripple rejection ratio : Increasing the capacitance value increases the rate, and reducing the value reduces the rate.
- Rise response speed : Increasing the capacitance value reduces the speed, and reducing the value increases the speed.
- Popping noise : Increasing the capacitance value reduces the noise, and reducing the value increases the noise.

### 7. Output coupling capacitor (C<sub>out</sub>)

C<sub>out</sub> is an output coupling capacitor used for DC cutting. However, this capacitor, C<sub>out</sub>, in combination with load impedance R<sub>L</sub> forms a high-pass filter and attenuates the low frequency signals. Take into account the cutoff frequency when determining the capacitance value. In addition, normally a chemical capacitor is used for this capacitor, but the capacitance value of chemical capacitors decreases at low temperatures, so the value should be set in accordance with this characteristic.

The cutoff frequency is expressed by the following formula.

$$f_c = 1/(2\pi \times R_L \times C_{out})$$

### 8. Output phase compensation capacitor (C<sub>osc</sub>)

The C<sub>osc</sub> capacitor is used to prevent output oscillation. Use a ceramic capacitor (recommended value = 0.1μF) with good high frequency characteristics, and locate this capacitor as close to the IC as possible.

### 9. Power supply capacitor (CV<sub>CC</sub>)

The CV<sub>CC</sub> capacitor is used to suppress the ripple component of the power supply line. Normally a chemical capacitor (recommended value = 10μF) is used for this capacitor. However, chemical capacitors have poor high frequency characteristics, so when using a CPU, DSP or other IC that generates digital noise in the set, it is recommended that a power supply bypass capacitor (ceramic capacitor, recommended value = approximately 0.1μF) be added to reject high-frequency components. Locate this bypass capacitor as close to the IC as possible.

### 10. NC pin treatment

Since the NC pins (pins 5 to 10) are connected to nothing internally, they may be left open. To increase the heat dissipation efficiency, however, it is recommended that the NC pins should be connected to the GND line.



## 11. Signal mixing methods

The following methods can be used to mix a beep, key tone or other signal into the audio signal. Note that when input to Pin 4 is selected, amplification of signals input from Pin 4 changes according to impedance Z4 connected to Pin 13.

### 11-1. Mixing method using resistors in the Pin 13 input front end

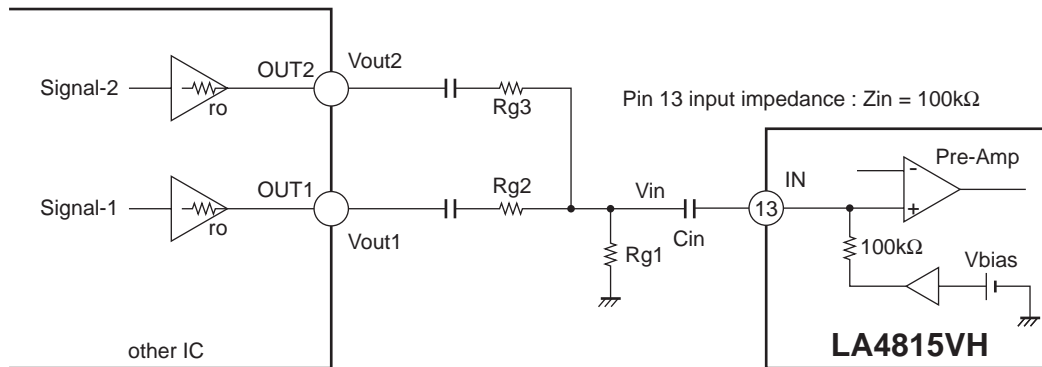

Figure 10

### 11-2. Method using input to Pin 4

- First signal system (Signal-1) voltage gain : Vg1  

$$Vg1 = 20 \log (Vout/Vin1) = 20 \log (4 \times (125 + Z4) (500 + (125 \times Z4/(125 + Z4)))/(25 \times Z4))$$

\*  $Z4 = R1 + ro$
- Second signal system (Signal-2) voltage gain : Vg2  

$$Vg2 = 20 \log (Vout/Vin2) = 20 \log (10000/(125 + R1))$$

\*  $fc2 = 1/(2\pi \times Cin2 \times (R1 + 125))$

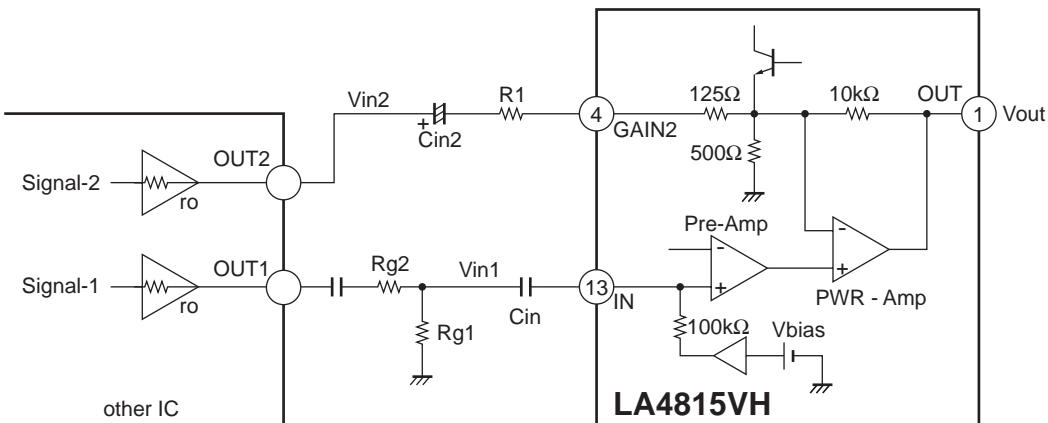

Figure 11

## 12. Short-circuit between pins

Turning on the power supply with some pins short-circuited may cause deterioration or breakdown. Therefore, when mounting the IC on a board, check to make sure that no short-circuit is formed between pins by solder or other foreign substances before turning on the power supply.

## 13. Load short circuit

Leaving the IC for a long time in the condition with a load short circuit may cause deterioration or breakdown. Therefore, never short-circuit the load.

## 14. Maximum ratings

When used under conditions near the maximum ratings, even a slight fluctuation in the conditions may cause the maximum ratings to be exceeded, possibly resulting in a breakdown or other accidents. Therefore, always provide enough margin for fluctuations in the supply voltage and other conditions, and use within a range not exceeding the maximum ratings.

# LA4815VH

## General characteristics (1)

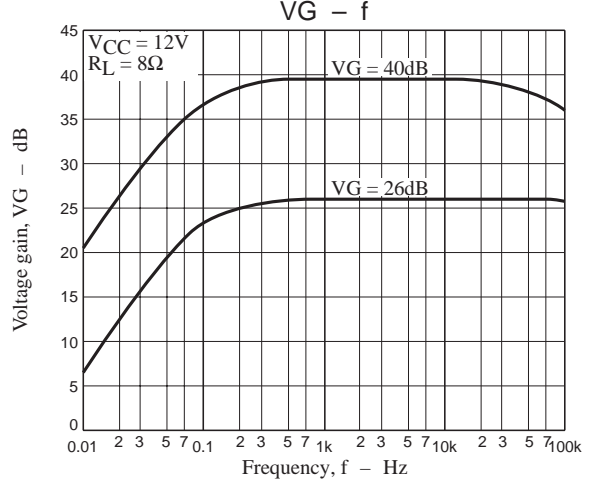
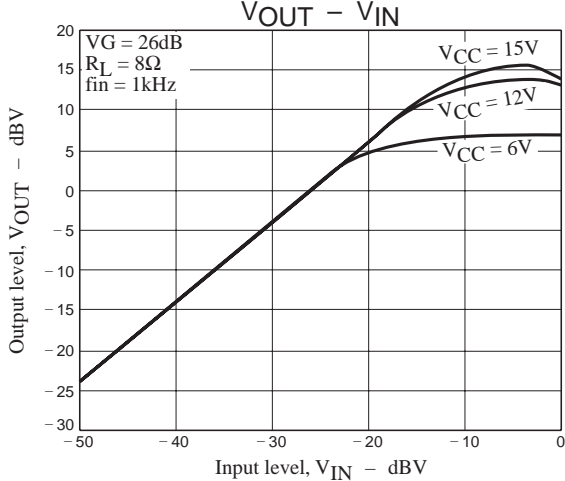
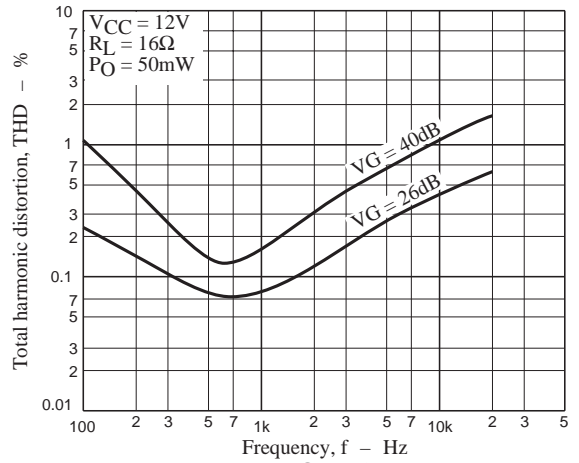
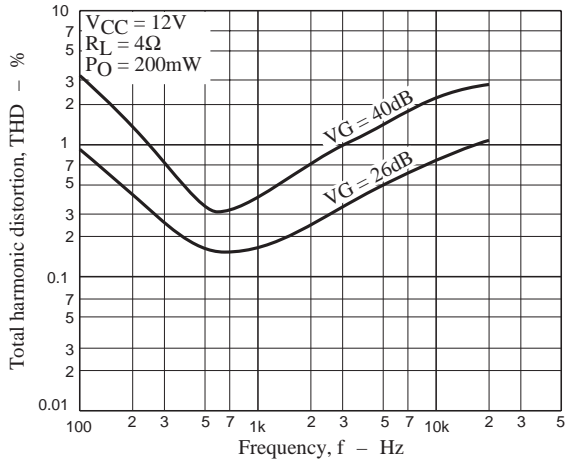
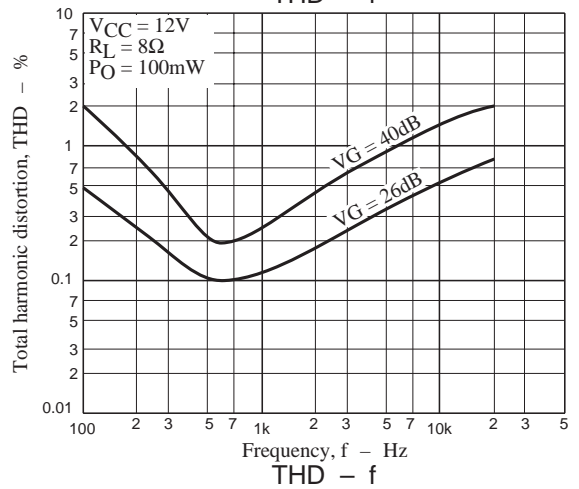
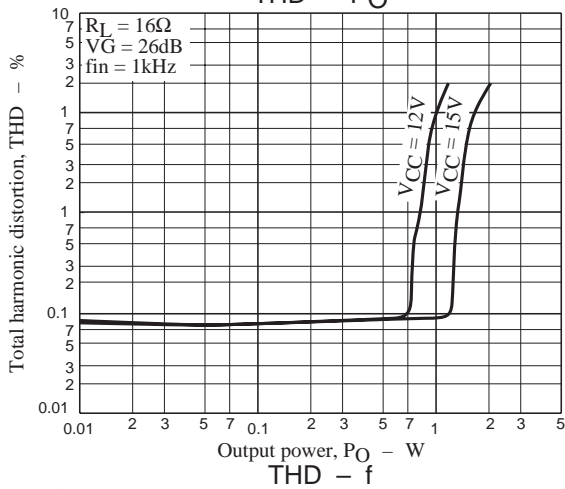
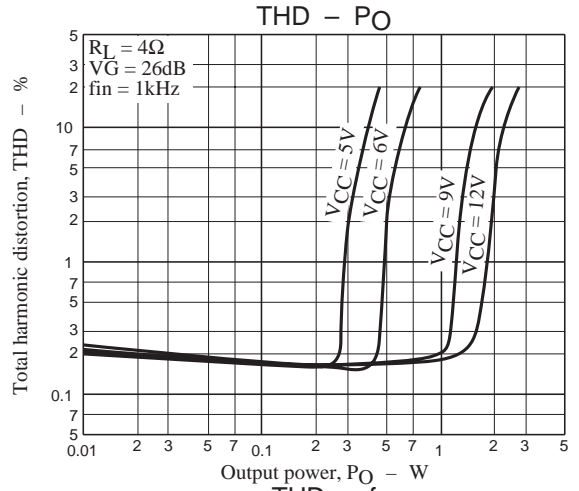
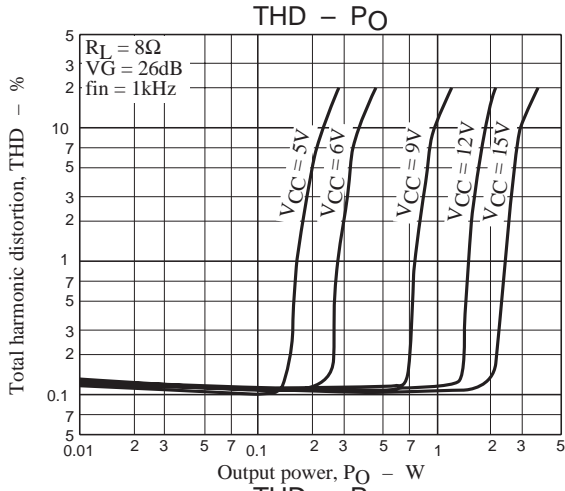

# LA4815VH

## General characteristics (2)

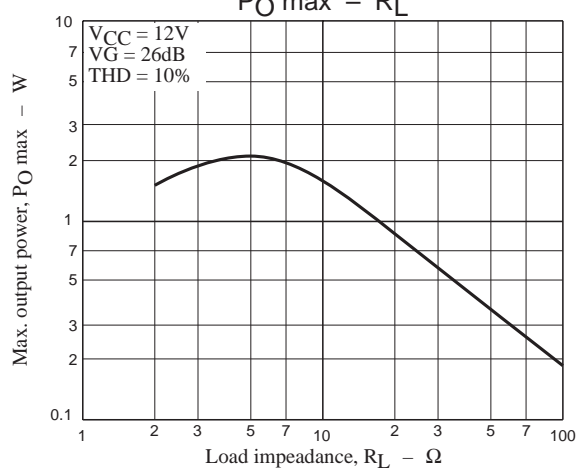
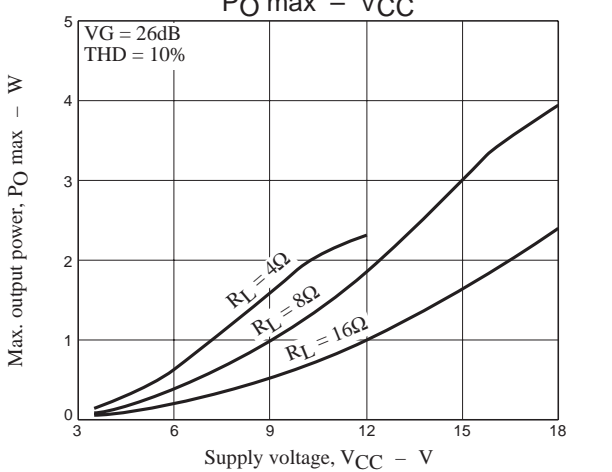
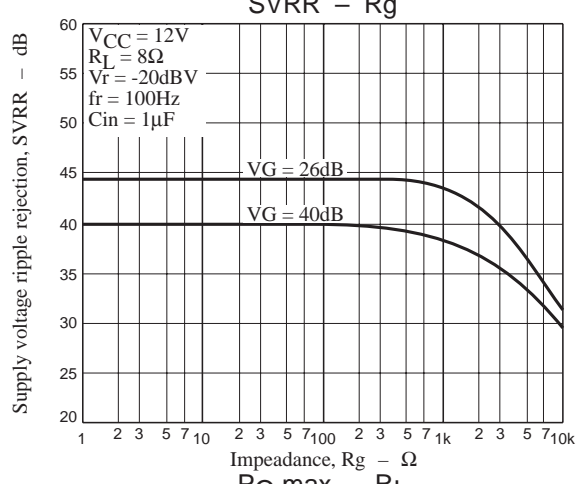
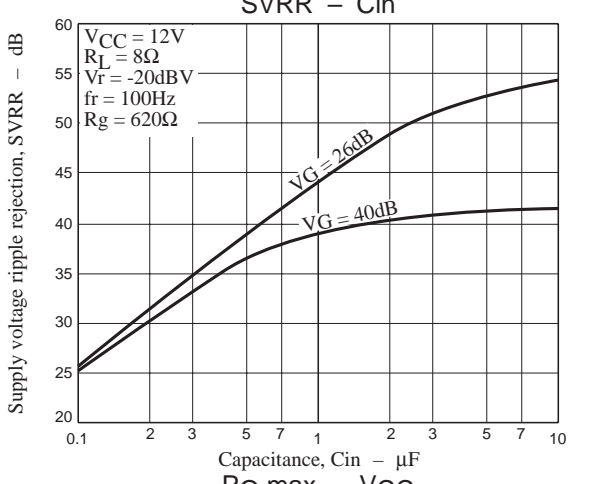
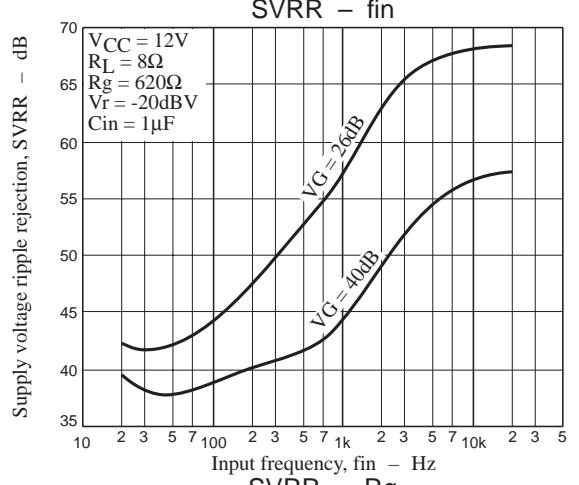
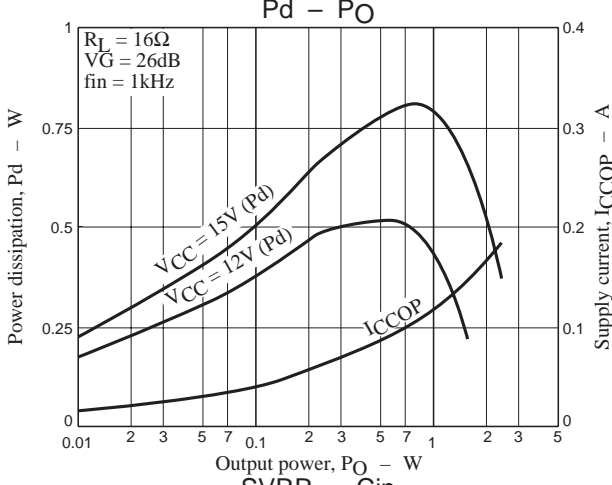
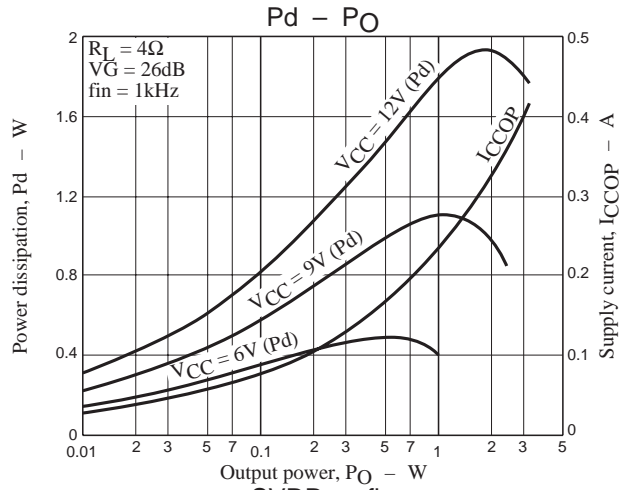
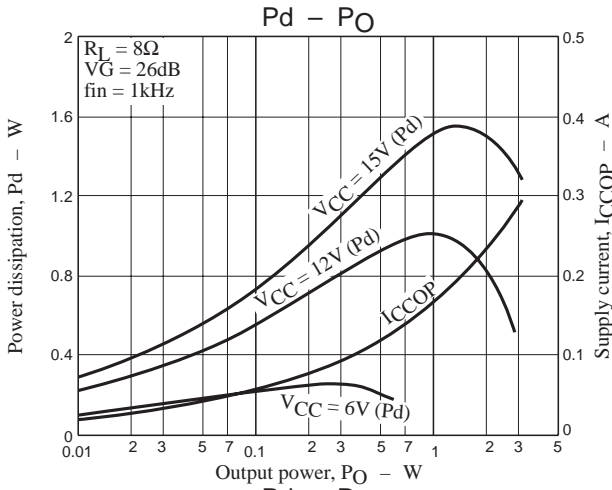

# LA4815VH

## General characteristics (3)

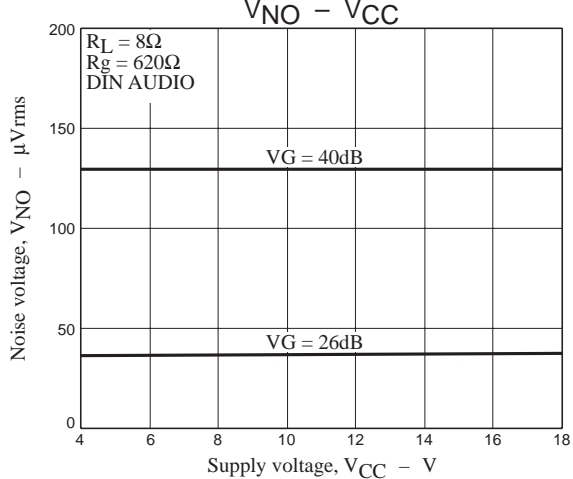
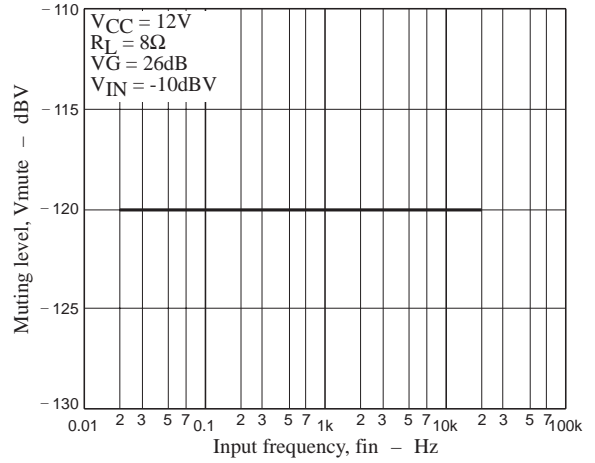
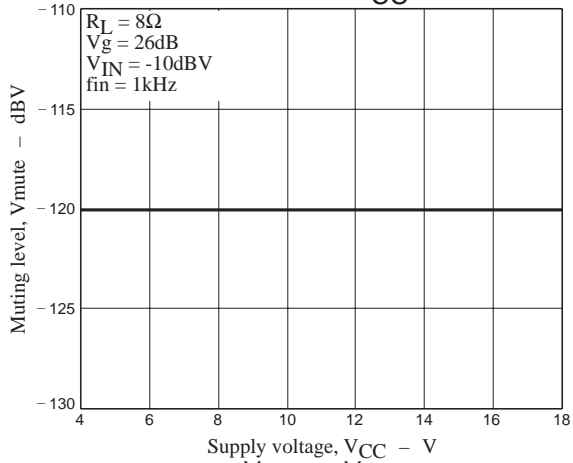
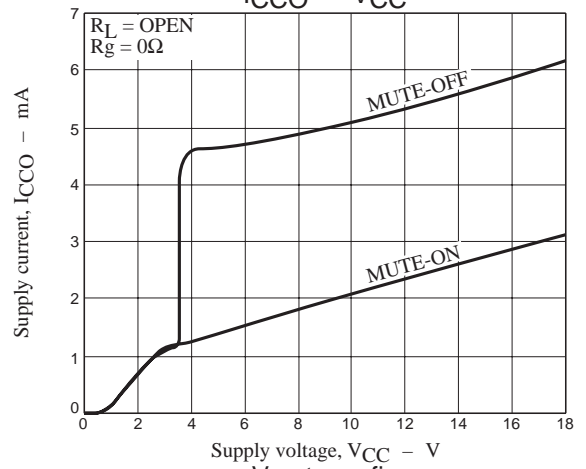
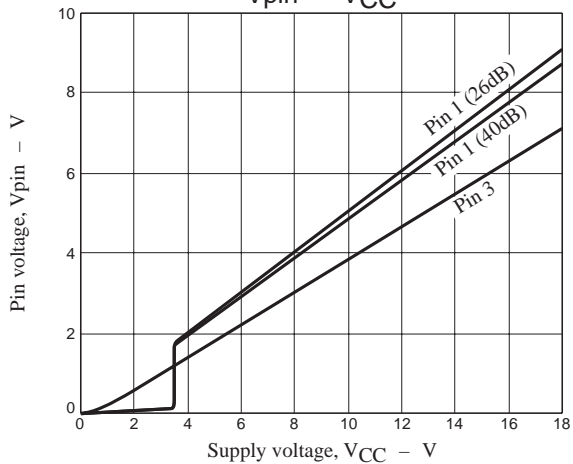
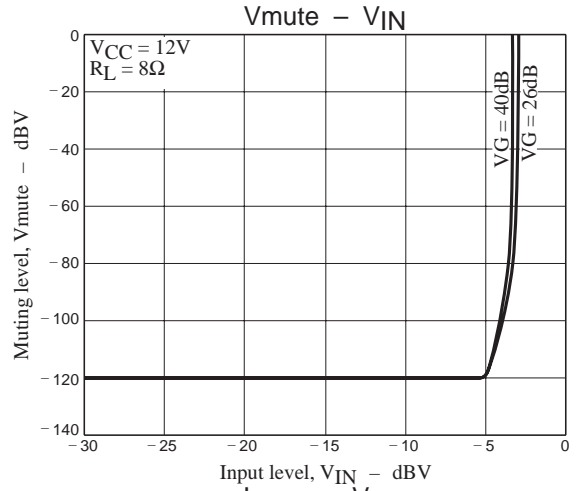
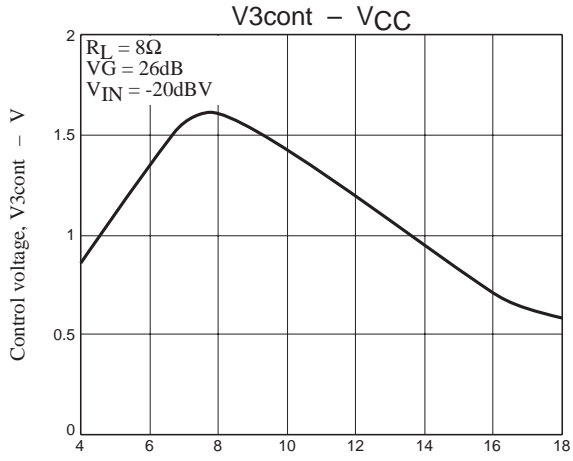

# LA4815VH

## Temperature characteristics (1)

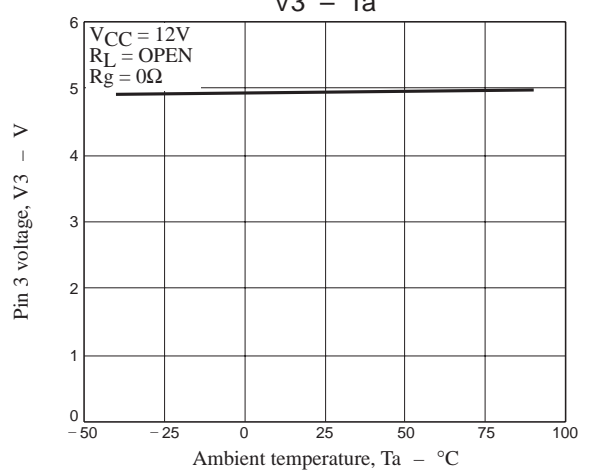
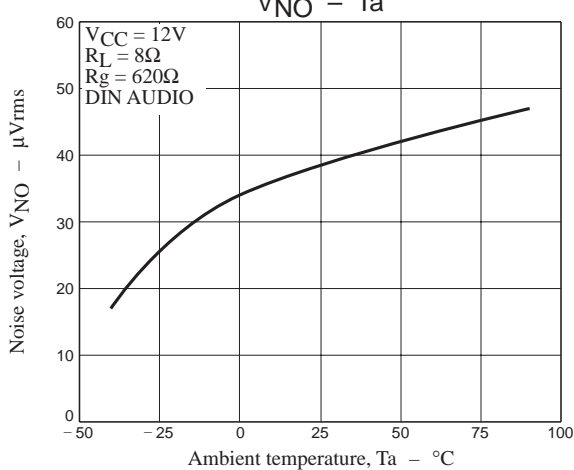
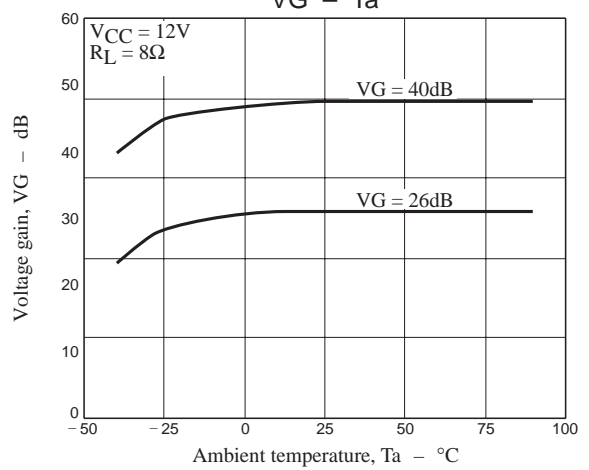
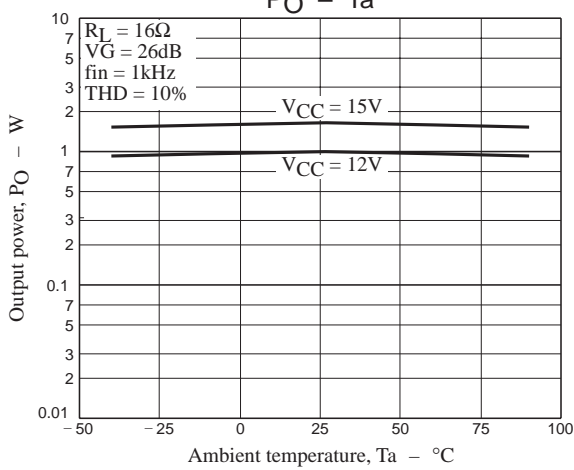
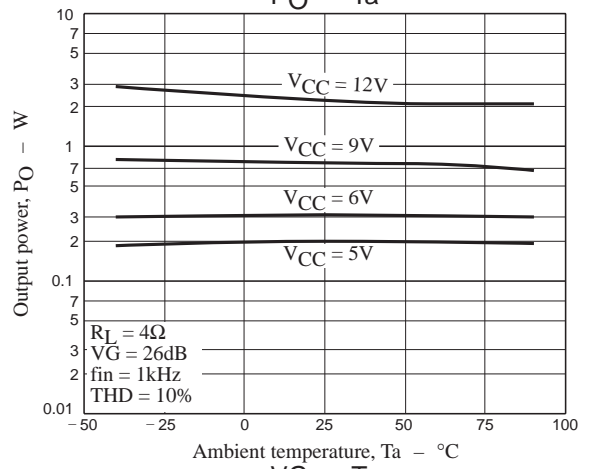
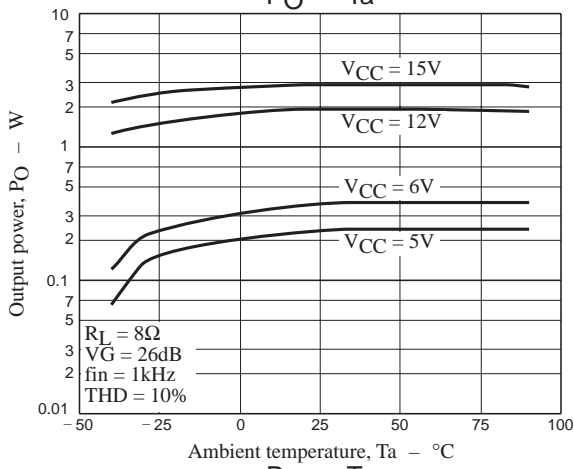
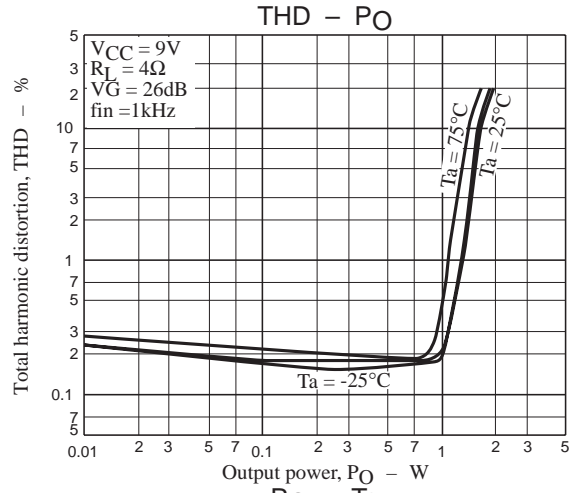
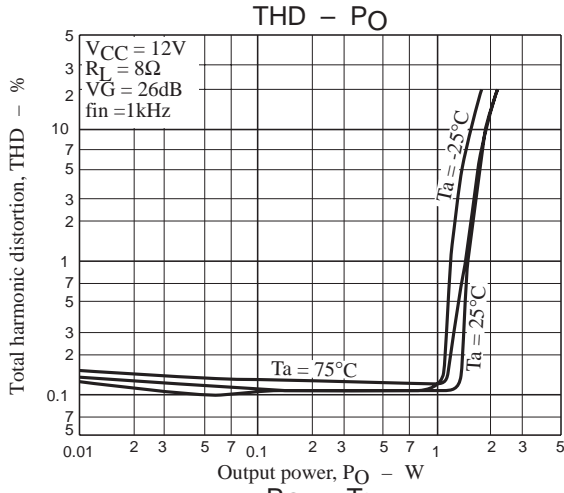

# LA4815VH

## Temperature characteristics (2)

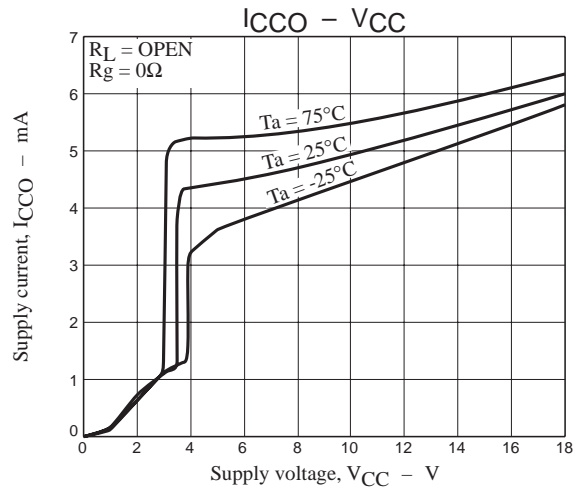
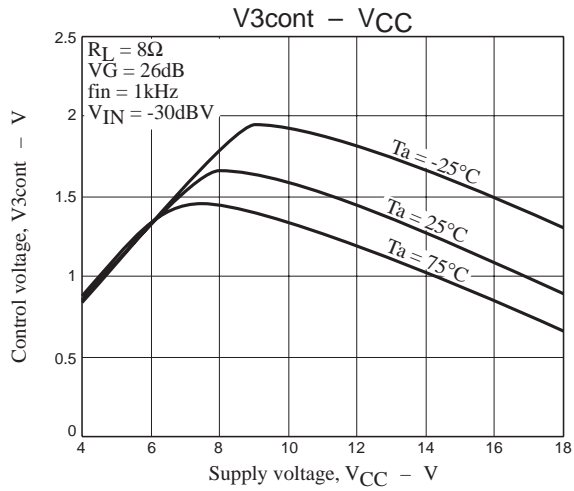

## Muting on and off transient characteristics

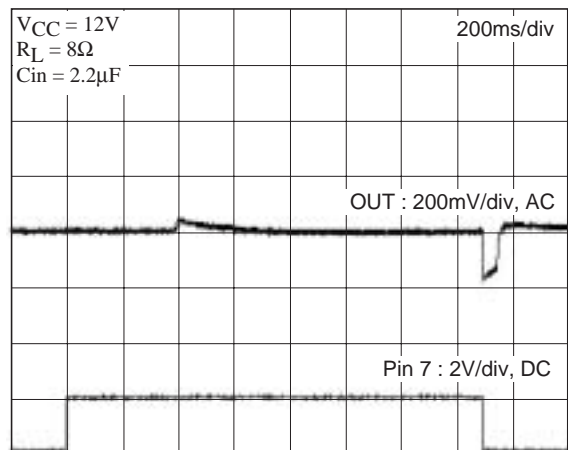
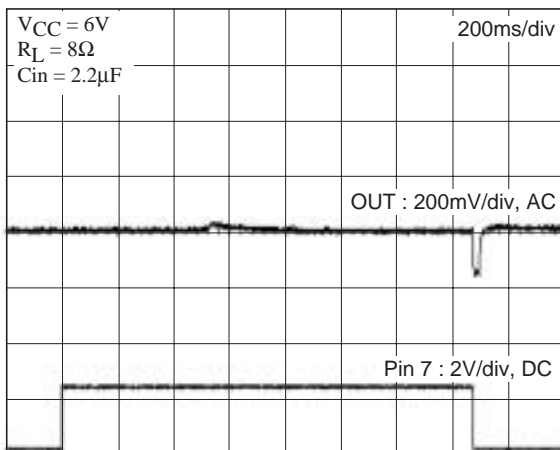
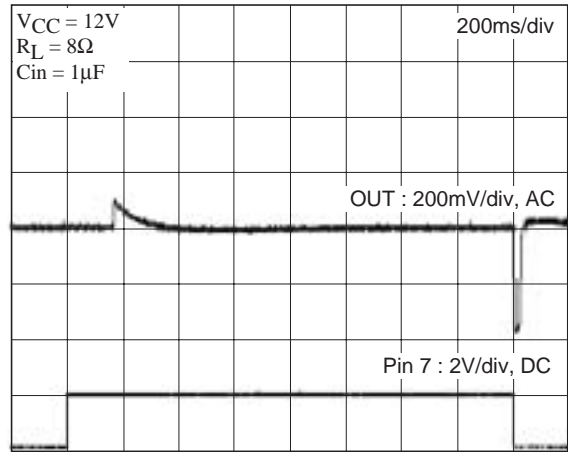
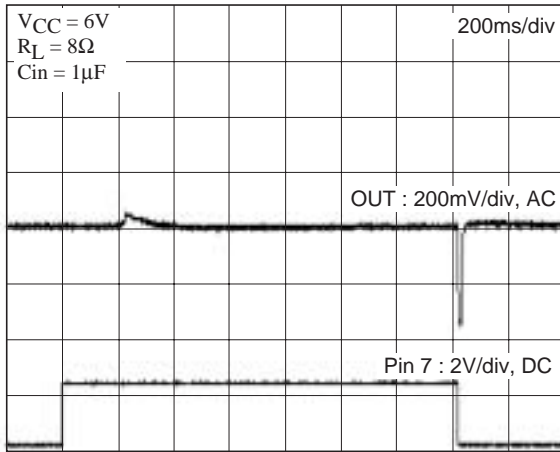

- SANYO Semiconductor Co.,Ltd. assumes no responsibility for equipment failures that result from using products at values that exceed, even momentarily, rated values (such as maximum ratings, operating condition ranges, or other parameters) listed in products specifications of any and all SANYO Semiconductor Co.,Ltd. products described or contained herein.
- SANYO Semiconductor Co.,Ltd. strives to supply high-quality high-reliability products, however, any and all semiconductor products fail or malfunction with some probability. It is possible that these probabilistic failures or malfunction could give rise to accidents or events that could endanger human lives, trouble that could give rise to smoke or fire, or accidents that could cause damage to other property. When designing equipment, adopt safety measures so that these kinds of accidents or events cannot occur. Such measures include but are not limited to protective circuits and error prevention circuits for safe design, redundant design, and structural design.
- In the event that any or all SANYO Semiconductor Co.,Ltd. products described or contained herein are controlled under any of applicable local export control laws and regulations, such products may require the export license from the authorities concerned in accordance with the above law.
- No part of this publication may be reproduced or transmitted in any form or by any means, electronic or mechanical, including photocopying and recording, or any information storage or retrieval system, or otherwise, without the prior written consent of SANYO Semiconductor Co.,Ltd.
- Any and all information described or contained herein are subject to change without notice due to product/technology improvement, etc. When designing equipment, refer to the "Delivery Specification" for the SANYO Semiconductor Co.,Ltd. product that you intend to use.
- Information (including circuit diagrams and circuit parameters) herein is for example only; it is not guaranteed for volume production.
- Upon using the technical information or products described herein, neither warranty nor license shall be granted with regard to intellectual property rights or any other rights of SANYO Semiconductor Co.,Ltd. or any third party. SANYO Semiconductor Co.,Ltd. shall not be liable for any claim or suits with regard to a third party's intellectual property rights which has resulted from the use of the technical information and products mentioned above.

This catalog provides information as of March, 2009. Specifications and information herein are subject to change without notice.



Компания «ЭлектроПласт» предлагает заключение долгосрочных отношений при поставках импортных электронных компонентов на взаимовыгодных условиях!

Наши преимущества:

- Оперативные поставки широкого спектра электронных компонентов отечественного и импортного производства напрямую от производителей и с крупнейших мировых складов;
- Поставка более 17-ти миллионов наименований электронных компонентов;
- Поставка сложных, дефицитных, либо снятых с производства позиций;
- Оперативные сроки поставки под заказ (от 5 рабочих дней);
- Экспресс доставка в любую точку России;
- Техническая поддержка проекта, помощь в подборе аналогов, поставка прототипов;
- Система менеджмента качества сертифицирована по Международному стандарту ISO 9001;
- Лицензия ФСБ на осуществление работ с использованием сведений, составляющих государственную тайну;
- Поставка специализированных компонентов (Xilinx, Altera, Analog Devices, Intersil, Interpoint, Microsemi, Aeroflex, Peregrine, Syfer, Eurofarad, Texas Instrument, Miteq, Cobham, E2V, MA-COM, Hittite, Mini-Circuits, General Dynamics и др.);

Помимо этого, одним из направлений компании «ЭлектроПласт» является направление «Источники питания». Мы предлагаем Вам помощь Конструкторского отдела:

- Подбор оптимального решения, техническое обоснование при выборе компонента;
- Подбор аналогов;
- Консультации по применению компонента;
- Поставка образцов и прототипов;
- Техническая поддержка проекта;
- Защита от снятия компонента с производства.



#### Как с нами связаться

**Телефон:** 8 (812) 309 58 32 (многоканальный)

**Факс:** 8 (812) 320-02-42

**Электронная почта:** [org@eplast1.ru](mailto:org@eplast1.ru)

**Адрес:** 198099, г. Санкт-Петербург, ул. Калинина, дом 2, корпус 4, литера А.