Amphenol Pcd

Connecting People & Technology

System Attachments



System Attachments

Designed to secure, guide and manage cable harnesses and pipes through aircraft and vehicles, Amphenol Pcd's System Attachments are engineered with strength, stability and weight reduction in mind. Designed for lean manufacturing, our System Attachments are rugged – able to withstand high vibration and shock, and non-conductive/non-corrosive – able to withstand many harsh environments for the lifetime of the aircraft. Based on the requirement, there are many styles and materials to choose from, and customization is always an option.

Amphenol Pcd

Connecting People & Technology

www.amphenolpcd.com

info@amphenolpcd.com

• 978.624.3400 •

SUPPORT CLAMPS

High Performance P-Clamps	5
High Performance OMEGA Clamps	6
High Performance LDG P-Clamps	7
High Performance C-Clamps	8

WIRING ACCESSORIES

Hat Supports	9
Harness Supports	10-12
Cable Supports	13-17
Cable Separators	18
Lightening Hole Bushing	19
Conduits	20

STANDOFFS

Standoffs	21
Amphenol Air LB France Standoffs	22

BRACKETS

Amphenol Air LB France Brackets	23-24
---------------------------------	-------

RACEWAYS

Accessories, ABS 2225	25
-----------------------	----

CUSTOM SOLUTIONS

Power Feeder Spacer & CRN Bracket	26
Fairlead Blocks	27
Jig Board Clamps	28



Engineered for lean manufacturing, the high performance P-Clamps were developed to replace and out perform traditional P-Clamps and Saddle Clamps. Featuring an overmold silicone cushion with PEEK polymer, our clamps are completely non-conductive/non-corrosive, lightweight, and very durable.

Specifications

Materials:

Plastic (Glass-Reinforced): Polyetheretherketone per MIL-P-46183
Elastomer protection: Silicone Rubber per ASTM-D-2000

Temperature Limits:

Operating temperature: -65°F to 350°F (-54°C to +107°C)
Excursions: Up to 500°F

Flammability:

UL94, VO; FAR25.853



Part Number	Size Number	Inner Cushion Diameter (ØD)		F		L		H		T		Weight	
		Inch	mm	Inch	mm	Inch	mm	Inch	mm	Inch	mm	Ounces	Grams
PCL150101	101	0.12	3.0	0.59	15.1	1.18	29.9	0.64	16.2	0.18	4.6	0.14	4.08
PCL150102	102	0.22	5.6	0.64	16.3	1.27	32.2	0.71	18.0	0.18	4.6	0.16	4.54
PCL150103	103	0.31	7.9	0.71	18.1	1.41	35.9	0.81	20.6	0.24	6.1	0.22	6.35
PCL150104	104	0.41	10.3	0.76	19.3	1.51	38.3	0.88	22.5	0.24	6.1	0.24	6.80
PCL150105	105	0.50	12.7	0.81	20.5	1.60	40.7	0.96	24.4	0.24	6.1	0.27	7.71
PCL150106	106	0.59	15.1	0.85	21.7	1.70	43.2	1.05	26.8	0.24	6.1	0.29	8.16
PCL150107	107	0.69	17.5	0.93	23.5	1.84	46.7	1.20	30.5	0.30	7.6	0.38	10.89
PCL150108	108	0.78	19.9	0.97	24.7	1.93	49.1	1.32	33.5	0.30	7.6	0.43	12.25
PCL150109	109	0.88	22.2	1.02	25.9	2.03	51.5	1.39	35.3	0.30	7.6	0.45	12.70
PCL150110	110	0.97	24.6	1.07	27.1	2.12	53.8	1.48	37.6	0.30	7.6	0.48	13.61
PCL150111	111	1.06	27.0	1.14	28.9	2.26	57.5	1.62	41.2	0.36	9.1	0.59	16.78
PCL150112	112	1.16	29.4	1.18	30.1	2.36	59.9	1.76	44.7	0.36	9.1	0.64	18.14
PCL150113	113	1.25	31.8	1.23	31.3	2.45	62.3	1.82	46.3	0.36	9.1	0.67	19.05
PCL150114	114	1.34	34.1	1.29	32.8	2.58	65.5	1.93	49.1	0.40	10.0	0.75	21.32
PCL150115	115	1.44	36.5	1.35	34.3	2.69	68.3	2.05	52.0	0.42	10.7	0.85	24.04

HIGH PERFORMANCE OMEGA CLAMPS



Engineered for lean manufacturing, the high performance Omega Clamps were developed to replace and out perform traditional P-Clamps and Saddle Clamps. Featuring an overmold silicone cushion with PEEK polymer, our clamps are completely non-conductive/non-corrosive, lightweight, and very durable.

Specifications

Materials:

Plastic (Glass-Reinforced): Polyetheretherketone per MIL-P-46183
 Elastomer protection: Silicone Rubber per ASTM-D-2000

Temperature Limits:

Operating temperature: -65°F to 350°F (-54°C to +107°C)
 Excursions: Up to 500°F

Flammability:

UL94, VO; FAR25.853



Part Number	Size Number	Inner Cushion Diameter (ØD)		F		L		H		E		C		Weight	
		Inch	mm	Inch	mm	Inch	mm	Inch	mm	Inch	mm	Inch	mm	Ounces	Grams
PCL250008	08	0.45	11.4	0.78	19.8	2.19	55.6	0.91	23.1	0.20	5.1	1.56	39.6	0.32	9.07
PCL250010	10	0.57	14.5	0.84	21.3	2.31	58.7	1.03	26.2	0.20	5.1	1.68	42.7	0.35	9.98
PCL250011	11	0.63	16.0	0.89	22.6	2.42	61.5	1.14	29.0	0.25	6.4	1.79	45.5	0.43	12.32
PCL250012	12	0.70	17.8	0.93	23.6	2.49	63.2	1.21	30.7	0.25	6.4	1.86	47.2	0.46	12.94
PCL250013	13	0.77	19.6	0.96	24.4	2.56	65.0	1.28	32.5	0.25	6.4	1.93	49.0	0.48	13.61
PCL250014	14	0.83	21.1	1.00	25.4	2.62	66.5	1.34	34.0	0.25	6.4	1.99	50.5	0.50	14.06
PCL250015	15	0.89	22.6	1.03	26.2	2.68	68.1	1.40	35.6	0.25	6.4	2.05	52.1	0.53	14.95
PCL250016	16	0.95	24.1	1.08	27.4	2.79	70.9	1.51	38.4	0.30	7.6	2.16	54.9	0.67	19.05
PCL250017	17	1.01	25.7	1.11	28.2	2.85	72.4	1.57	39.9	0.30	7.6	2.22	56.4	0.70	19.96
PCL250018	18	1.07	27.2	1.14	29.0	2.91	73.9	1.63	41.4	0.30	7.6	2.28	57.9	0.72	20.41
PCL250019	19	1.13	28.7	1.17	29.7	2.97	75.4	1.69	42.9	0.30	7.6	2.34	59.4	0.75	21.32
PCL250020	20	1.20	30.5	1.22	31.0	3.07	78.0	1.79	45.5	0.33	8.4	2.44	62.0	0.80	22.68
PCL250021	21	1.26	32.0	1.24	31.5	3.10	78.7	1.82	46.2	0.30	7.6	2.47	62.7	0.80	22.68
PCL250022	22	1.33	33.8	1.27	32.3	3.17	80.5	1.89	48.0	0.30	7.6	2.54	64.5	0.82	23.13
PCL250024	24	1.45	36.8	1.33	33.8	3.29	83.6	2.01	51.1	0.30	7.6	2.66	67.6	0.84	23.80
PCL250025	25	1.51	38.4	1.36	34.5	3.35	85.1	2.07	52.6	0.30	7.6	2.72	69.1	0.90	25.40
PCL250026	26	1.57	39.9	1.39	35.3	3.41	86.6	2.13	54.1	0.30	7.6	2.78	70.6	0.91	25.85
PCL250028	28	1.70	43.2	1.46	37.1	3.57	90.7	2.29	58.2	0.33	8.4	2.91	73.9	1.06	30.16
PCL250032	32	1.95	49.5	1.58	40.2	3.82	97.0	2.54	64.5	0.33	8.4	3.16	80.3	1.17	33.11

HIGH PERFORMANCE LDG P-CLAMPS



Amphenol Pcd's LDG P-Clamps use a soft rubber for clamp cushioning, thereby reducing wear and tear on mission-critical cable harnesses without compromising the strength and performance of the clamp itself. Specifically designed for high performance aerospace cables, such as the MT/MTL product lines, they are easy to use, simple to maintain, and available in 17 different sizes.

Specifications

Materials:

Plastic (Glass-Reinforced): Polyetheretherketone per MIL-P-46183; Black Elastomer protection: Silicone Rubber; 20 durometer Shore A; Light Green

Temperature Limits:

Operating temperature: -65°F to 350°F (-54°C to +107°C)
Excursions: Up to 500°F

Flammability:

Clamp base: UL94, VO; FAR25.853
Cushion: Meets UL94, HB



Part Number	Size Number	Inner Cushion dia. (ØD)		MIN. Cable Size		MAX. Cable Size		F		L		H		T		Weight	
		Inch	mm	Inch	mm	Inch	mm	Inch	mm	Inch	mm	Inch	mm	Inch	mm	Ounces	Grams
PCL400100	100	0.030	.76	0.060	1.52	0.190	4.83	0.59	15.1	1.18	29.9	0.64	16.2	0.18	4.6	0.15	4.30
PCL400101	101	0.125	3.18	0.155	3.94	0.248	6.30	0.59	15.1	1.18	29.9	0.64	16.2	0.18	4.6	0.14	4.08
PCL400102	102	0.219	5.56	0.249	6.32	0.342	8.69	0.64	16.3	1.27	32.2	0.71	18.0	0.18	4.6	0.16	4.54
PCL400103	103	0.313	7.95	0.343	8.71	0.436	11.07	0.71	18.1	1.41	35.9	0.81	20.6	0.24	6.1	0.22	6.35
PCL400104	104	0.407	10.34	0.437	11.1	0.530	13.46	0.76	19.3	1.51	38.3	0.88	22.5	0.24	6.1	0.24	6.80
PCL400105	105	0.501	12.73	0.531	13.49	0.623	15.82	0.81	20.5	1.60	40.7	0.96	24.4	0.24	6.1	0.27	7.71
PCL400106	106	0.594	15.09	0.624	15.85	0.718	18.24	0.85	21.7	1.70	43.2	1.05	26.8	0.24	6.1	0.29	8.16
PCL400107	107	0.689	17.5	0.719	18.26	0.811	20.60	0.93	23.5	1.84	46.7	1.20	30.5	0.30	7.6	0.38	10.89
PCL400108	108	0.782	19.86	0.812	20.62	0.905	22.99	0.97	24.7	1.93	49.1	1.32	33.5	0.30	7.6	0.43	12.25
PCL400109	109	0.876	22.25	0.906	23.01	0.998	25.35	1.02	25.9	2.03	51.5	1.39	35.3	0.30	7.6	0.45	12.70
PCL400110	110	0.969	24.61	0.999	25.37	1.092	27.74	1.07	27.1	2.12	53.8	1.48	37.6	0.30	7.6	0.48	13.61
PCL400111	111	1.063	27.00	1.093	27.76	1.186	30.12	1.14	28.9	2.26	57.5	1.62	41.2	0.36	9.1	0.59	16.78
PCL400112	112	1.157	29.39	1.187	30.15	1.280	32.51	1.18	30.1	2.36	59.9	1.76	44.7	0.36	9.1	0.64	18.14
PCL400113	113	1.251	31.78	1.281	32.54	1.373	34.87	1.23	31.3	2.45	62.3	1.82	46.3	0.36	9.1	0.67	19.05
PCL400114	114	1.344	34.14	1.374	34.9	1.467	37.26	1.29	32.8	2.58	65.5	1.93	49.1	0.40	10.0	0.75	21.32
PCL400115	115	1.438	36.53	1.468	37.29	1.561	39.65	1.35	34.3	2.69	68.3	2.05	52.0	0.42	10.7	0.85	24.04
PCL400116	116	1.532	38.91	1.562	39.67	1.655	42.04	1.39	35.3	2.78	70.6	2.14	54.3	0.42	10.7	0.92	26.04

HIGH PERFORMANCE C-CLAMPS

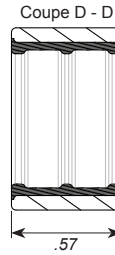
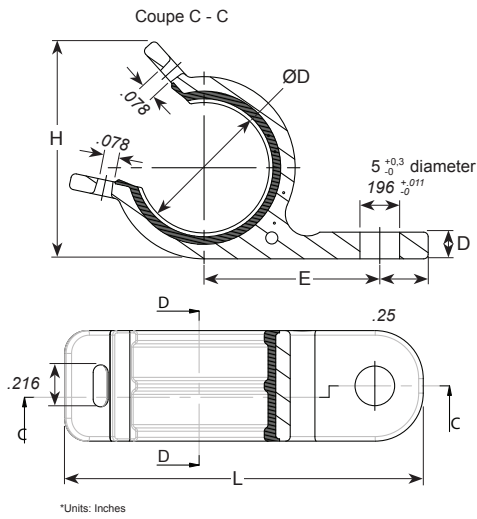

Amphenol Pcd's C-Clamps (Cable Clamps) provide routing, support and fixing for cable harnesses of various diameters. They are used in the wing sections of aircrafts, in the fuselage for power and electrical cables, as well as inside the cabin for in-flight entertainment or cabin service systems. Different materials and configurations are available depending on the temperature and routing of the conduits (including versions for use inside the fuel tank).

Specifications

Materials:

- Plastic: Black Polyamide
- Elastomer protection: Brown Silicon or Blue Fluorosilicone

Temperature Limits:

Operating temperature: -65°F to 350°F (-54°C to +107°C)

Flammability:

Conforms to ABD031 standard

Fluid Resistance:

- Brown version: NATO F44, AS 1241, MIL PRF 680 (type 1), 5606,7870, 23699, 87937 (diluted), 87252 and AMS1428
- Blue version: Resistant in complete immersion during 96h

AALBF PN	Cushion Color	Size	Diameter (ØD)	E (Inch)	L (Inch)	H (Inch)	D (Inch)	Weight
								Grams
003262 101 00	Brown	01	0.2-0.28	0.67	1.37	0.61	.14	2.1
003262 111 00	Blue							
003262 102 00	Brown	02	0.28-0.4	0.73	1.49	0.74	.14	2.5
003262 112 00	Blue							
003262 103 00	Brown	03	0.4-0.55	0.80	1.63	0.91	.14	3.2
003262 113 00	Blue							
003262 104 00	Brown	04	0.55-0.77	0.91	1.87	1.14	.14	4.0
003262 114 00	Blue							
003262 105 00	Brown	05	0.77-1.05	1.05	2.14	1.42	.14	5.3
003262 115 00	Blue							
003262 106 00	Brown	06	1.05-1.38	1.22	2.47	1.77	.23	8.3
003262 116 00	Blue							
003262 107 00	Brown	07	1.38-1.77	1.42	2.85	2.16	.33	11.5
003262 117 00	Blue							
003262 108 00	Brown	08	1.55-1.88	1.57	2.86	2.50	.32	14.6
003262 118 00	Blue							

Specifications

Materials:

Nylon per ASTM-D-4066 PA0121
 Elastomer protection: Brown Silicon or Blue Fluorosilicone

Temperature Limits:

Long-term exposure: 167°F (75°C)
 Short-term exposure: 248°F (120°C)

Flammability:

FAR 25.853

Designed to secure and guide wire bundles throughout an aircraft, Amphenol Pcd's Harness and Hat Supports were designed for lean manufacturing and durability. Built in a one-piece, lightweight design with multiple fixing points, the high performance products are strong, durable and make wire bundle installation and maintenance easy. They are able to support large bundles and high stress requirements.

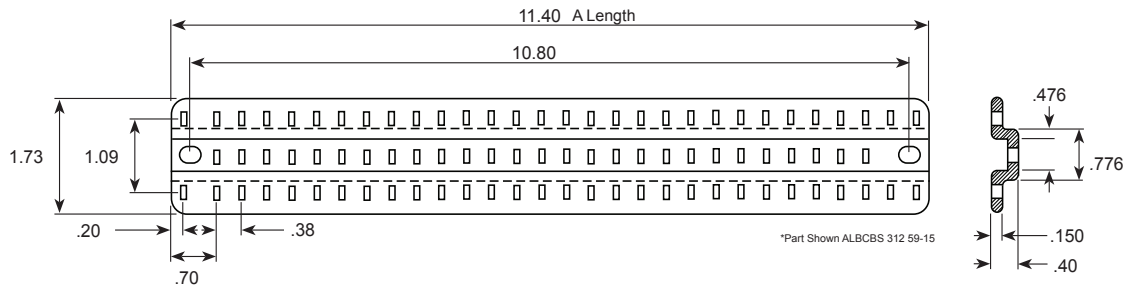

Part Number	A Length (* .040 inch)	Weight (g)
ALBCBS 312 59-01	8.90	45.8
ALBCBS 312 59-02	9.15	47.1
ALBCBS 312 59-03	9.90	50.9
ALBCBS 312 59-04	5.40	27.8
ALBCBS 312 59-05	8.40	43.2
ALBCBS 312 59-06	9.53	49.0
ALBCBS 312 59-07	8.00	41.2
ALBCBS 312 59-08	7.65	39.4
ALBCBS 312 59-09	6.90	35.5
ALBCBS 312 59-10	6.10	31.4
ALBCBS 312 59-11	12.90	66.4
ALBCBS 312 59-12	8.10	41.7
ALBCBS 312 59-13	7.70	39.6
ALBCBS 312 59-14	12.78	65.7
ALBCBS 312 59-15	11.40	58.6
ALBCBS 312 59-16	6.90	35.5
ALBCBS 312 59-17	4.54	23.4
ALBCBS 312 59-18	8.40	43.2
ALBCBS 312 59-19	7.19	37.0
ALBCBS 312 59-21	10.40	53.5
ALBCBS 312 59-23	11.30	58.1
ALBCBS 312 59-25	7.38	38.0
ALBCBS 312 59-27	6.20	31.9
ALBCBS 312 59-29	9.37	48.2
ALBCBS 312 59-31	8.10	41.7
ALBCBS 312 59-35	6.40	32.9





Part Number	A Length (Inch)	Maximum Weight (g)	Fixing Points
ALBCBS 303 59-1	1.30	1.08	1
ALBCBS 303 59-3	2.30	1.86	2
ALBCBS 303 59-5	3.30	2.63	3
ALBCBS 303 59-7	4.30	3.90	4
ALBCBS 303 59-9	5.30	4.17	5
ALBCBS 303 59-11	6.30	4.99	6
ALBCBS 303 59-13	7.30	5.80	7
ALBCBS 303 59-15	8.30	6.58	8
ALBCBS 303 59-17	9.30	7.39	9
ALBCBS 303 59-19	10.30	8.16	10
ALBCBS 303 59-21	11.30	8.98	11
ALBCBS 303 59-23	12.30	9.80	12

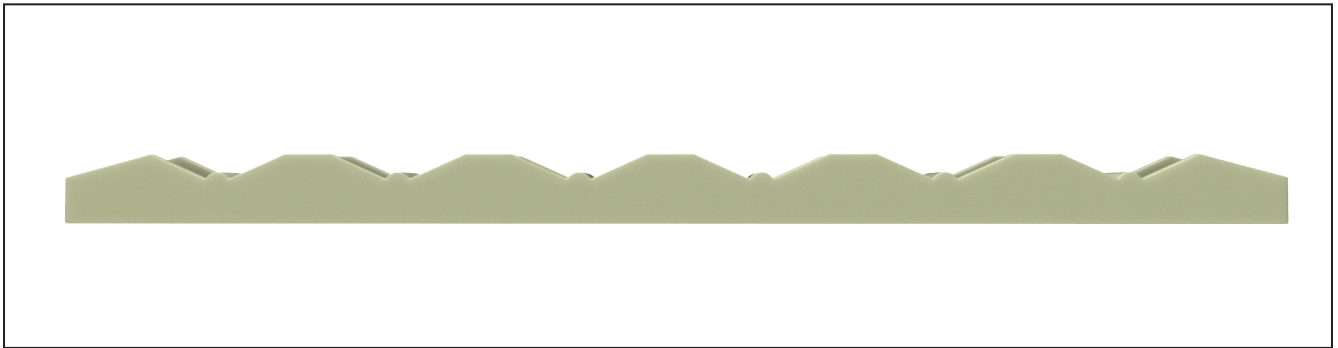

Part Number	A Length (Inch)	Maximum Weight (g)	E Fixing (Inch)	@ Fixing Points
ALBCBS 020 59-11	13.05	72.6	11.59	8
ALBCBS 020 59-13	11.55	63.5	10.09	7
ALBCBS 020 59-15	10.05	54.4	8.59	6
ALBCBS 020 59-17	8.55	45.4	7.09	5
ALBCBS 020 59-19	7.05	36.3	5.59	4

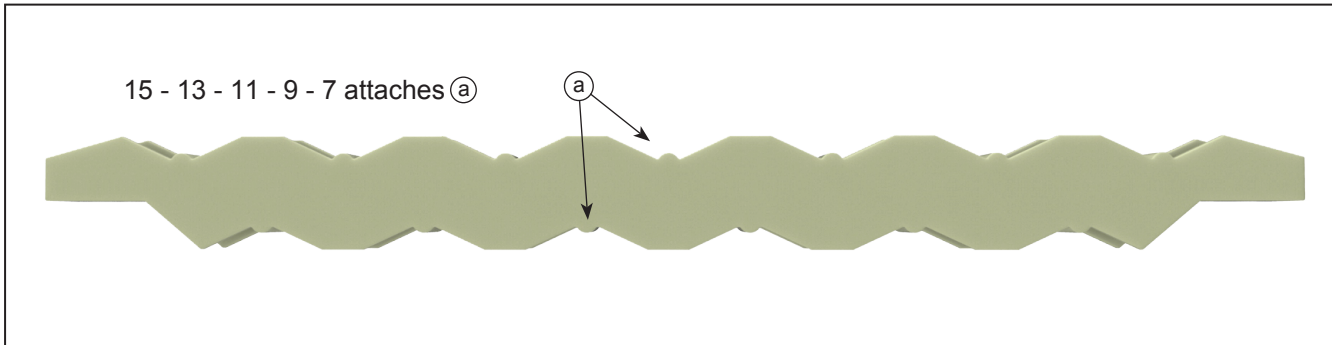
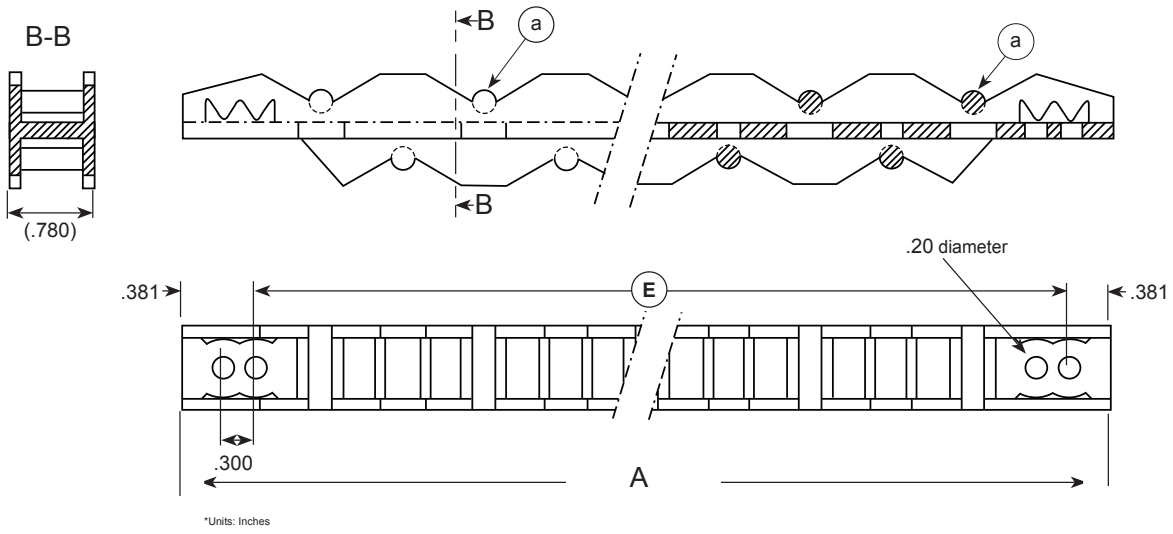

Part Number	A Length (Inch)	Maximum Weight (g)	E Fixing (Inch)	(a) Fixing Points
ALBCBS 030 59-21	13.05	59.0	11.59	15
ALBCBS 030 59-23	11.55	49.9	10.09	13
ALBCBS 030 59-25	10.05	45.4	8.59	11
ALBCBS 030 59-27	8.55	36.3	7.09	9
ALBCBS 030 59-29	7.05	27.3	5.59	7

Specifications

Materials:

Nylon per ASTM-D-4066 PA0121
 Elastomer protection: Brown Silicon or Blue Fluorosilicone

Environment:

Operating temperature: -67°F to +275°F
 (-55°C to +135°C)

Flammability:

To meet FAR 25.853 amtd 25-853 (a) and ADB031

Fluid Resistance:

ASTM D 543, MIL-T-81533, TT-T-266, TT-M-261, ASTM D 1635,
 MIL-T-5624, MIL-T-83133

Amphenol Pcd's Cable Supports are made to fix on an aircraft's airframe, helping to secure and manage cable harnesses as they run throughout the aircraft body. They are offered in nylon and are designed for use in airframe, fuel tank, and engine applications. Available in various standard configurations and sizes, Amphenol Pcd also offers customized products to help meet specific customer requirements.

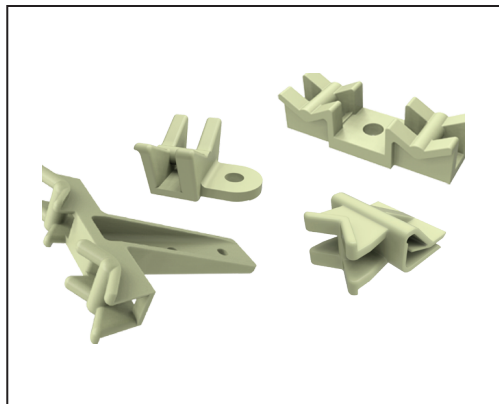

Application

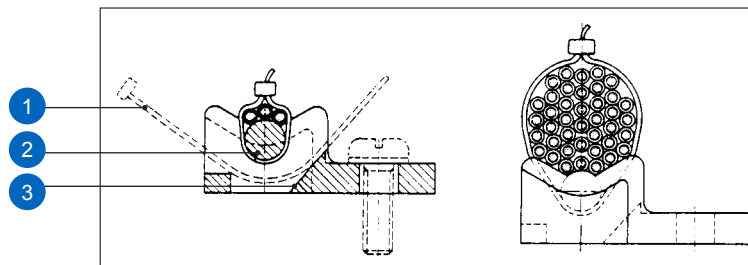







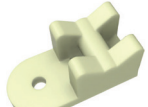
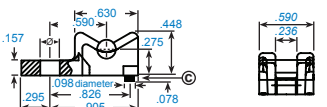
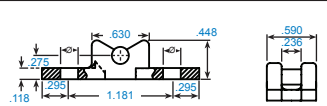

- 1 Cable tie
- 2 Cylindrical support: guides the cables, ensures optimal fixing
- 3 Ramp: to ease quick feed-in of cable tie

User Warning

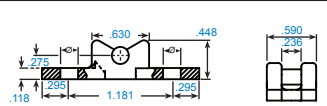
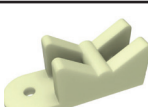
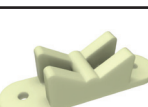
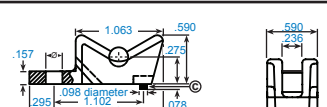
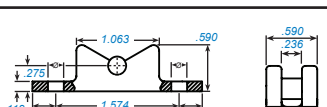
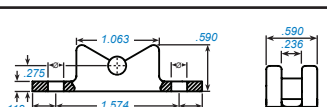
- Eliminates any dehydration agent in storage.
- If the piece regains its humidity, this may cause a coloration of the material.
- Surface coloration does not affect technical properties of the material.
- Wiring accessories conform to ROHS and REACH requirements.

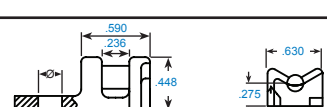
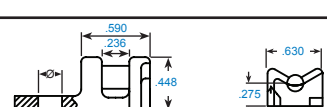
STRAIGHT SUPPORTS

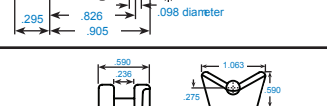
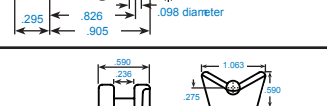
Single

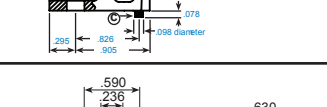
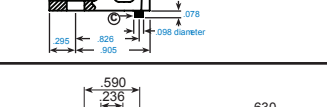
	Ø Wiring Minimum-Maximum (Inch)	Part Number Without Block (C)	Part Number With Block (C)	Weight (g)	Hole Ø (Inch)	
	0.08-0.59	003261 100 59	003261 150 59	2.2	0.2	
		003261 200 59	003261 250 59	2.2	0.13	
	0.08-0.59	ALBCBS 001 05	-	3	0.13	
		0.08-1.18	003261 102 59	003261 152 59	2.2	0.2
	0.08-1.18	003261 202 59	003261 252 59	2.2	0.13	
		003261 127 59	-	4.5	0.2	
		003261 227 59	-		0.13	
	0.08-0.59	003261 114 59	003261 164 59	2.2	0.2	
		003261 113 59	003261 163 59		0.13	
	0.08-1.18	003261 118 59	003261 168 59	3.2	0.2	
		003461 117 59	003261 167 59		0.13	
	0.08-0.59	003261 173 59	-	3	0.13	
		003261 203 59	-	4.2	0.13	

Double

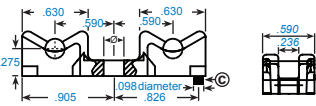
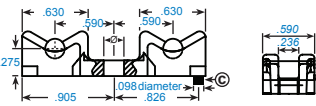
	Ø Wiring Minimum-Maximum (Inch)	Part Number Without Block (C)	Part Number With Block (C)	Weight (g)	Hole Ø (Inch)	
	0.08-0.59	003261 101 59	003261 151 59	3.7	0.2	
		003261 201 59	003261 251 59		0.13	

ANGLED SUPPORTS

Single

	Part Number	Ø Wiring Minimum-Maximum (Inch)	Weight (g)	Hole Ø (Inch)	X (Inch)	
	003261 501 59	0.08-0.59	3.64	.125	-	
	003261 511 59		3.62	.137	-	
	003261 115 59	0.08-0.59	1.7	0.13	-	
	003261 116 59	0.08-1.18	2.4		-	
	003261 111 59	0.08-0.59	1.8	.129	.724	
	003261 109 59		2		.941	
	003261 131 59		1.8		.767	
	003261 129 59		2		.984	
	003261 121 59		1.8		.767	
	003261 119 59		2		.984	
	003261 210 59	0.08-1.18	3	.129	.866	
	003261 110 59		3.3		1.102	
	003261 230 59		3		.866	
	003261 130 59		3.3		1.102	
	003261 220 59		3		.866	
	003261 120 59		3.3		1.102	

ANGLED SUPPORTS

Double

	Part Number	Ø Wiring Minimum-Maximum (Inch)	Weight (g)	Hole Ø (Inch)	
	003261 503 59	0.08-1.18	6.14	.125	
	003261 513 59		6.13	.137	
	003261 515 59	0.08-0.787	6.10	0.14	
	003261 502 59	0.08-0.59	4.92	.125	
	003261 512 59		4.9	.137	

Heavy Duty Supports



	Part Number	Ø Wiring Minimum-Maximum (Inch)	Weight (g)	Hole Ø (Inch)	
	ALBCBS 308 59	0.08-0.59	8.17	0.129	



STRINGER SUPPORTS FOR SPECIFIC APPLICATIONS

	Part Number	Ø Wiring Minimum-Maximum (Inch)	Weight (g)	Hole Ø (Inch)	
	ALBCBS 307 59 01	0.08-0.59	3.63	0.129	
	ALBCBS 307 59 02				

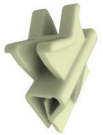
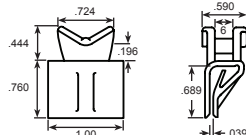
STRINGER SUPPORTS

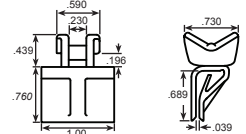
Clamping Supports

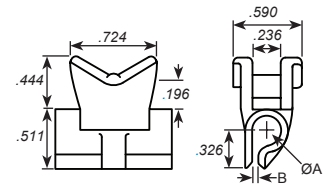
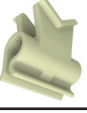
	Part Number	Ø Wiring Minimum-Maximum (Inch)	Weight (g)	
	ALBCBS 310 59-01	0.08-0.59	3.4	
	ALBCBS 310 59-02			

	Part Number	Ø Wiring Minimum-Maximum (Inch)	Color	Weight (g)	Ø A (Inch)	B (Inch)	
	ALBCBS 304 59-01	0.08-0.59	Green	2.86	0.200	0.2	
	ALBCBS 304 59-03		White	2.99	0.250	0.13	
	ALBCBS 304 59-07		Grey	3.44	0.280		

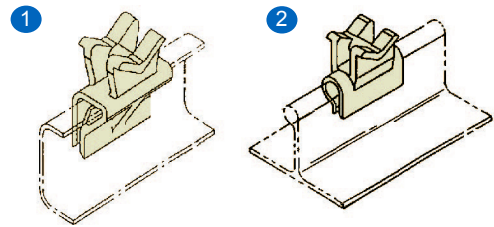

- 1 Angled Support
- 2 Straight Support

CABLE SEPARATORS



Amphenol Pcd's Cable Separators are used to help separate cable harnesses from one another, aiding in organizing cable routing throughout the aircraft. Available in either Nylon or PEEK, they maintain clearance between two parallel or crossing cable harnesses preventing wire abrasion. Nine different versions are available and they are qualified to Airbus standard ABS1144.



Air LB P/N	Airbus P/N	Number of Parts					Max Bundle Diameter (Inch)	Length (Inch)	Weight (+/- 10%) (g)
		Head 1	Head 2	Tube 1	Tube 2	Tube 3			
3308 8301 000	ABS1144A25A	2	-	1	-	-	0.63	0.98	4.65
3308 8302 000	ABS1144A50A	2	-	-	1	-		1.97	6.33
3308 8303 000	ABS1144A75A	2	-	-	-	1		2.95	7.81
3308 8304 000	ABS1144B25A	-	2	1	-	-	1.77	0.98	6.96
3308 8305 000	ABS1144B50A	-	2	-	1	-		1.97	8.63
3308 8306 000	ABS1144B75A	-	2	-	-	1		2.95	10.11
3308 8307 000	ABS1144C25A	1	1	1	-	-	1.77	0.98	5.81
3308 8308 000	ABS1144C50A	1	1	-	1	-		1.97	7.48
3308 8309 000	ABS1144C75A	1	1	-	-	1		2.95	8.96

Amphenol P/N	Ø D (Inch)	Weight (g)	Color
ALBCBS 350-0A	0.76	0.18	White
ALBCBS 351-0A	0.85	0.18	Blue
ALBCBS 352-0A	1.10	0.18	Yellow
ALBCBS 353-0A	1.39	0.17	Natural
ALBCBS 360-05	1.33	0.13	Yellow
ALBCBS 360-06	1.77	0.13	White
ALBCBS 360-07	1.49	0.25	Blue
ALBCBS 360-08	0.99	0.18	Green
ALBCBS 360-10	1.36	0.25	Green
ALBCBS 360-11	1.35	0.18	Black
ALBCBS 360-12	1.49	0.18	Green
ALBCBS 360-13	1.38	0.16	White
ALBCBS 360-14	0.98	0.04	Black
ALBCBS 360-15	1.23	0.04	Blue
ALBCBS 360-17	1.48	0.06	Yellow
ALBCBS 360-19	0.79	0.06	White
ALBCBS 360-21	0.79	0.10	Green
ALBCBS 360-25	0.76	0.04	Black
ALBCBS 360-26	0.88	0.04	Natural
ALBCBS 360-27	0.88	0.01	Yellow
ALBCBS 361-01	0.98	0.035	Natural
ALBCBS 365-01	1.50	0.05	Natural
ALBCBS 366-01	1.50	0.02	Natural

Additional sizes available upon request

Amphenol Pcd's QuickSNAP Lightening Bushings are made to help guide wired bundles through the aircraft's frame and stringers. Unlike traditional lightening bushings, our products significantly reduce installation times and reduce the amount of foreign object debris (FOD). The lightweight QuickSNAP's are made with smooth edges in order to reduce wire chaffing, and although they are available in various standard configurations and sizes, customization is always an option.

Specifications

Materials:

Nylon per ASTM-D-4066 PA0121

Elastomer protection: Brown Silicon or Blue Fluorosilicone

Environment:

Operating temperature: -67°F to 302°F (-55°C to 150°C)

Flammability:

FAR 25.853



Traditional Lightening Hole Bushing



15 Minutes to Install

6 part installation

- 3 Rivets
- 1 Nylon part
- 1 Caterpillar
- 1 Sheet Metal part

QuickSNAP Lightening Hole Bushing



15 Seconds to Install

1 part installation

- 1 Amphenol QuickSNAP Lightening Hole Bushing



Our high performance Conduits are intended to be supported by Amphenol Pcd P-Clamps. Conduits provide support for wire bundles where separation or protection from other systems or structures is necessary. Conduits can be installed anywhere in the aircraft, including the wings. Although Amphenol Pcd Conduits are available in various standard configurations and sizes, we offer custom products as well.



Amphenol P/N	DIM "A"	Ø B (Inch)
ALBFTD 002-00	5.50	1.06
ALBFTD 003-00	7.25	1.06
ALBFTD 004-00	5.50	0.38
ALBFTD 005-00	7.25	0.69
ALBFTD 007-00	7.63	0.38
ALBFTD 008-00	5.50	0.51
ALBFTD 009-00	8.00	0.44

TOLERANCES: .XX ± .03, ±.XXX .010



Amphenol P/N	DIM "A"	Ø B (Inch)	Ø C (Inch)
ALBFTD 001-00	0.50	1.85	0.375
ALBFTD 006-00	1.25	2.81	0.625

TOLERANCES: .XX ± .03, ±.XXX .010

Specifications

Materials:

Glass-Reinforced PEEK Per MIL-P-46183 with metallic threaded insert

Environment:

Operating temperature: -67°F to +266°F (-55°C to +130°C)

Flammability:

UL94, VO; FAR25.853

Made to help guide wire bundles through the aircraft, Amphenol Pcd's High Performance Standoffs are very strong, durable, and lightweight. Our Standoffs are made with glass-reinforced PEEK a very robust, non-conductive/non-corrosive, and lightweight material with excellent chemical resistance. They come with a locking feature for security, are designed with ribs to provide additional strength, and support a wide range of clamp sizes and harness supports for added convenience.



90 Degree

Amphenol P/N	A Length (Inch)	B Thickness (Inch)
ALBSTO 002-02	0.54	0.16
ALBSTO 002-04	0.74	
ALBSTO 002-06	0.94	
ALBSTO 002-08	1.14	
ALBSTO 003-10	1.34	
ALBSTO 003-12	1.54	0.175
ALBSTO 003-14	1.74	
ALBSTO 003-16	1.94	
ALBSTO 003-18	2.14	
ALBSTO 003-20	2.34	
ALBSTO 003-22	2.54	
ALBSTO 003-24	2.74	



Straight

Amphenol P/N	A Height (Inch)
ALBSTO 051-03	0.30
ALBSTO 051-04	0.40
ALBSTO 051-06	0.60
ALBSTO 051-08	0.80
ALBSTO 051-10	1.00
ALBSTO 051-12	1.20
ALBSTO 051-14	1.40
ALBSTO 051-16	1.60
ALBSTO 051-18	1.80
ALBSTO 051-20	2.00

Specifications

Materials:

Black thermoplastic with metallic threaded insert

Environment:

Operating temperature : Type 1: -67°F to +266°F (-55°C to +130°C)
Type 2: -67°F to +185°F (-55°C to +85°C)

Flammability:

Conform to ABD031 standard

Fluid Resistance:

NATO F44, AS 1241, MIL PRF 680 (type 1), 5606, 7870, 23699, 87937 (diluted), 87252 and ASM 1428



Support Type I

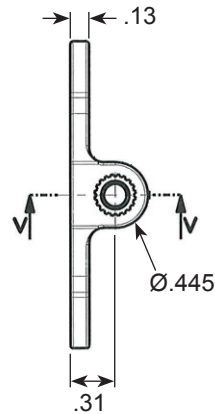
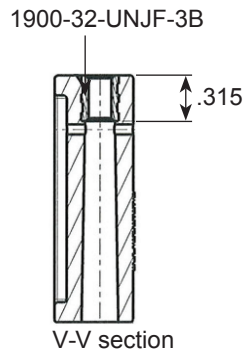
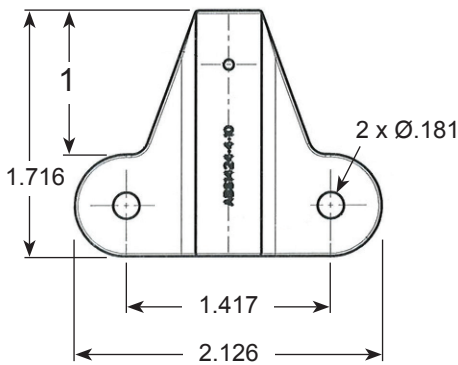

Type	1
Amphenol P/N	3450 0031 313
Weight (g)	14

Support Type II

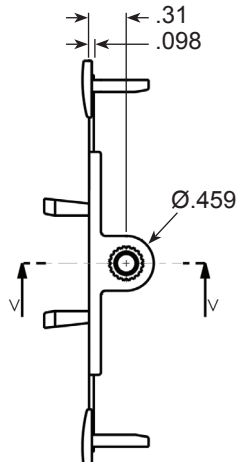
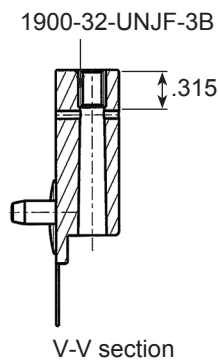
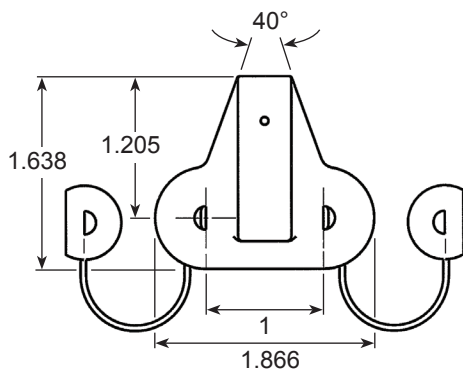

Type	2
Amphenol P/N	3540 0034 356
Weight (g)	9.2

ABS 1694

Specifications

Materials:

Black thermoplastic
Shocks: RTCA/DO-160G cat. E

Environment:

Operating temperature: -67°F to +185°F (-55°C to +85°C)

Flammability:

Conform to ABD031 standard

Fluid Resistance:

N, O, P and R types: NATO F44, AS 1241, MIL PRF 680 (type 1), 5606, 7870, 23699, 87937 (diluted), 87252 and AMS 1428
S type: Resistant in complete immersion during 24h

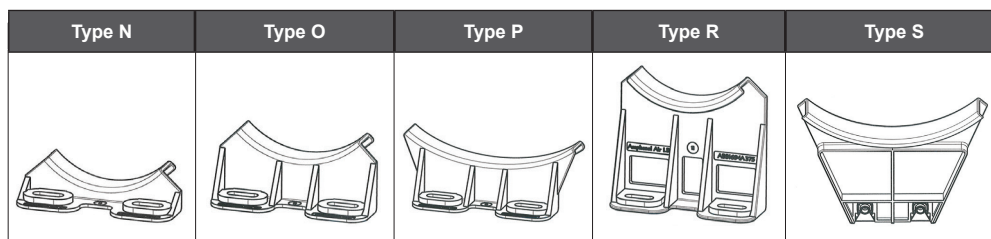

*ABS 1694 & 1695 conform to ROHS and REACH Requirements

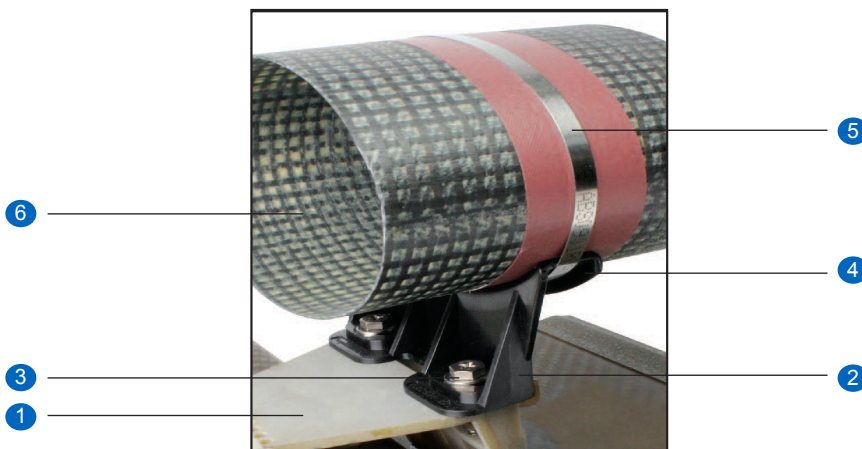

- 1 Panel
- 2 ABS1694 fixing system
- 3 Panel mounting system (screw + washer not supplied)
- 4 Spout for ring clamp
- 5 Ring clamp
- 6 Pipe clamp

ABS 1695

Specifications

Materials:

Black thermoplastic

Environment:

Operating temperature: -67°F to +185°F (-55°C to +85°C)

Flammability:

Conform to ABD031 standard

Fluid Resistance:

NATO F44, AS 1241, MIL PRF 680 (type 1), 5606,7870, 23699, 87937 (diluted), 87252 and ASM 1428



*ABS 1694 & 1695 conform to ROHS and REACH Requirements



- ① Pipe Clamp
- ② ABS1695 fixing system
- ③ Fixing system for pipe clamps (screw and nut not supplied)
- ④ ABS 1339 cable clamp
- ⑤ Locking system for fixing system on panel with integrated locking pin

ACCESSORIES, ABS 2225

Specifications

Materials:

Black thermoplastic

Environment:

Operating temperature: -67°F to +185°F (-55°C to +85°C)

Flammability:

Conform to ABD031 standard

Fluid Resistance:

NATO F44, AS 1241, Mil PRF 680 (type 1), 5606, 7870, 23699, 87937 (diluted), 87252 and ASM 1428

This accessory is a bar of various lengths which allows the user to fix Cable Clamps ABS1339 on up to three sides. The adapter on each end of the bar allows the user to select the desired position for the panel mounting 0°, 90°, 180°, 270°.

ABS 2225 Systems- Adapter



AALBF P/N	Weight (g)	A (Inch)	B (Inch)	C (Inch)
3540 0131 000	11.7	.591	1.142	1.378
3540 0132 000	13.2	.945	1.496	1.732
3540 0133 000	14.7	1.299	1.850	2.086

Pin for ABS 2225 Body



AALBF P/N	Weight (g)
3540 0042 356 SCS	11.7



AALBF P/N	H (Inch)	L (Inch)	Weight (g)
3540 8201 000	-	1.279	11
3540 8202 000	.984	2.264	17
3540 8203 000	1.968	3.248	23
3540 8204 000	2.953	4.232	29
3540 8205 000	3.937	5.216	34
3540 8206 000	4.921	6.200	39
3540 8207 000	5.905	7.185	46
3540 8208 000	6.889	8.169	52
3540 8209 000	7.874	9.153	58
3540 8210 000	8.858	10.137	63
3540 8211 000	9.842	11.122	69
3540 8212 000	10.826	12.106	75
3540 8213 000	11.811	13.090	81
3540 8214 000	12.795	14.074	87
3540 8215 000	13.779	15.059	93
3540 8216 000	14.763	16.043	98
3540 8217 000	15.747	17.027	104
3540 8218 000	16.732	18.011	110
3540 8219 000	17.716	18.995	116
3540 8220 000	18.700	19.980	122
3540 8221 000	19.684	20.964	127
3540 8222 000	20.669	21.948	133
3540 8223 000	21.653	22.932	140
3540 8224 000	22.637	23.917	145



POWER FEEDER SPACER & CRN BRACKET

Power Feeder Spacer

Power Feeder Spacers provide a constant spacing between the power feeder. The custom design of this product allows a six degree rotation on the power feeder bundle and doesn't fight against the natural flow of the cable. It is designed to sit within Omega Clamps used as anchor points.



CRN Bracket

The CRN Bracket is custom made to hold the "Current Return Network" in place inside a composite aircraft. Very easy to install with a bolt, the CRN system is fixed in place by hand with an integrated snap system on the bracket. The bracket is made of PEEK material, and silicone is compression overmolded onto the bracket.



Designed to ensure that pipes and tubes are properly secured throughout their entire length, Amphenol Pcd's Fairlead Blocks provide stability against surges and vibration and are available in multiple materials depending on required chemical environment. Our blocks accommodate a wide range of tube diameters and the products can be supplied with all-captive components, eliminating loose parts and potential FOD.

Specifications

- High Performance Materials: Strong, Durable & Lightweight
- All-Captive Components: Lean manufacturing; reduces costs
- Design & Engineering: Prevents wire and tube chaffing; protects against surges and harsh vibration
- Fairlead blocks are custom-built to order. Contact Amphenol Pcd with required dimensions

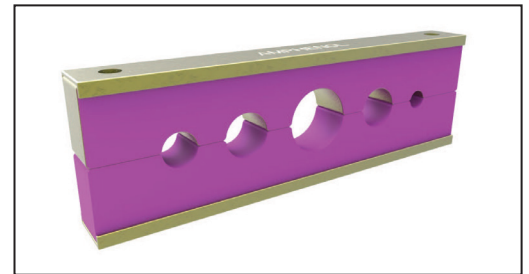

Rails/Spacers Specifications		
Materials	Coating	Application
Aluminum Alloy 6061-T6 or 2024-T3	Chemical Conversion Coating per MIL-C-5541 Class 1A	Light Duty
Stainless Steel per ASTM A109	Cadmium Plate per QQ-P416, TYPE II Class I	High Performance
Carbon Fiber Composite	Contact Amphenol Pcd for availability and information	

Cushion Block Specifications				
Materials	Specifications			
	Temperature Range	Chemical Resistance	Color	Duro
Ethylene Propylene Rubber (EPR)	-65°F to 275°F (-54°C to 135°C)	Areas exposed to Skydrol	Purple	55-75
Nitrile Butadiene (Buna-N)		Fuel Tank Application	Yellow	
Silicone		Fire Resistant, Low smoke, Low toxicity requirements	-	
Fluorosilicone	-65°F to 500°F (-54°C to 260°C)	High temperature areas; Engine Applications	-	

Custom Fairlead Blocks



Amphenol Pcd's Jig Board Clamps are made for pre-installation wire harness assembly. Made of Acetal, our durable clamps maintain their original shape after continuous use and their smooth edges diminish wear on the harnesses as they are being assembled. Developed in multiple sizes, Amphenol Pcd's Jig Board Clamps can accommodate a wide range of cable diameters, while the one-piece design enables efficient inventory management.



Specifications

- Designed with Acetal: Strong durable; long life-time
- Various Sizes: Accommodates wide range of wire diameters
- One-Piece Design: Simple and easy to use
- Smooth Edges: Limits wire chaffing and reduces wear and tear
- No elastic band or straps required: Minimizes installation time

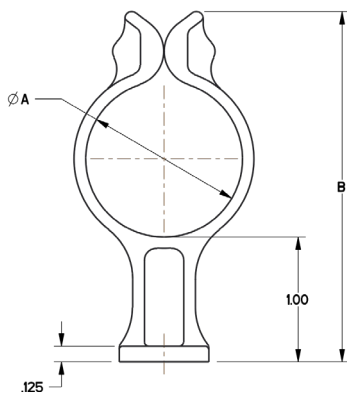

Amphenol P/N	Ø A (Inch)	B (Inch)	C (Inch)
ALBCLP 001 01	0.50	1.85	0.375
ALBCLP 001 02	1.25	2.81	0.625
ALBCLP 001 03	2.00	3.80	0.625
ALBCLP 001 04	0.88	2.36	0.500

Material: Acetal

AMPHENOL PCD PRODUCTS



Backshells



Cable Solutions & Cable Adapters
NEW



Relay Sockets & Junction Modules



System Attachments



Luminus Series, Pegasus Series
NEW



Terminal Blocks



SIM



Rectangular



Circular



Waterproof Solutions



Field Bus



Military Audio /Power

Amphenol Pcd

Amphenol Pcd, a subsidiary of Amphenol Corporation, is one of the world's leading suppliers of interconnect products for Military, Commercial Aerospace and Industrial applications. Located north of Boston in Beverly, Massachusetts, the company designs and manufactures a wide range of products - System Attachments, Junction Modules, Relay Sockets, Terminal Blocks, Rectangular & Circular connectors, and Cable Assemblies & Adapters.

Each product is made and engineered with the highest quality standards in the industry. With facilities in North America and Asia, Amphenol Pcd products are chosen by hundreds of OEMs around the world, reliant on Amphenol's technical excellence, global network of distributors, and cost-effective solutions for custom systems.

Amphenol Pcd

Connecting People & Technology

Notice: Specifications are subject to change without notice. Contact your nearest Amphenol Corporation Sales Office for the latest specifications. All statements, information and data given herein are believed to be accurate and reliable, but are presented without guarantee, warranty, or responsibility of any kind expressed or implied. Statements or suggestions concerning possible use of our products are made without representation or warranty that any such use is free of patent infringement and are not recommendations to infringe any patent. The user should not assume that all safety measures are indicated or that other measures may not be required. Specifications are typical and may not apply to all connectors.

© 2015 Amphenol Pcd

Amphenol Pcd

72 Cherry Hill Dr. Beverly , MA. 01915

info@amphenolpcd.com • (978) 624.3400

www.amphenolpcd.com

FOLLOW US





Компания «ЭлектроПласт» предлагает заключение долгосрочных отношений при поставках импортных электронных компонентов на взаимовыгодных условиях!

Наши преимущества:

- Оперативные поставки широкого спектра электронных компонентов отечественного и импортного производства напрямую от производителей и с крупнейших мировых складов;
- Поставка более 17-ти миллионов наименований электронных компонентов;
- Поставка сложных, дефицитных, либо снятых с производства позиций;
- Оперативные сроки поставки под заказ (от 5 рабочих дней);
- Экспресс доставка в любую точку России;
- Техническая поддержка проекта, помощь в подборе аналогов, поставка прототипов;
- Система менеджмента качества сертифицирована по Международному стандарту ISO 9001;
- Лицензия ФСБ на осуществление работ с использованием сведений, составляющих государственную тайну;
- Поставка специализированных компонентов (Xilinx, Altera, Analog Devices, Intersil, Interpoint, Microsemi, Aeroflex, Peregrine, Syfer, Eurofarad, Texas Instrument, Miteq, Cobham, E2V, MA-COM, Hittite, Mini-Circuits, General Dynamics и др.);

Помимо этого, одним из направлений компании «ЭлектроПласт» является направление «Источники питания». Мы предлагаем Вам помощь Конструкторского отдела:

- Подбор оптимального решения, техническое обоснование при выборе компонента;
- Подбор аналогов;
- Консультации по применению компонента;
- Поставка образцов и прототипов;
- Техническая поддержка проекта;
- Защита от снятия компонента с производства.



Как с нами связаться

Телефон: 8 (812) 309 58 32 (многоканальный)

Факс: 8 (812) 320-02-42

Электронная почта: org@eplast1.ru

Адрес: 198099, г. Санкт-Петербург, ул. Калинина, дом 2, корпус 4, литера А.