

500 mA Synchronous BUCK Regulator

Features

- Input Range of 2.7V to 5.5V
- 3 Operating Modes: PWM, PFM and LDO
- Integrated BUCK and Synchronous Switches
- Ceramic or Electrolytic Input/Output Filtering Capacitors
- 750 kHz Fixed Switching Frequency
- Oscillator Synchronization to 1 MHz PWM Mode
- Auto-Switching from PWM/PFM Operation
- 100% Duty Cycle Capable for Low Input Voltage
- 500 mA Continuous Output Current Capability
- Integrated Under-Voltage Lock-Out Protection
- Integrated Over-Temperature Protection
- Integrated Soft Start Circuitry
- Low Output Voltage Capability to 0.9V
- Temperature Range: -40°C to +85°C
- Small 8-Pin MSOP Package

Applications

- Low Power Handheld CPUs and DSPs
- Cellular Phones
- Organizers and PDAs
- Digital Cameras
- +5V or +3.3V Distributed Voltages
- USB Powered Devices

Package Type

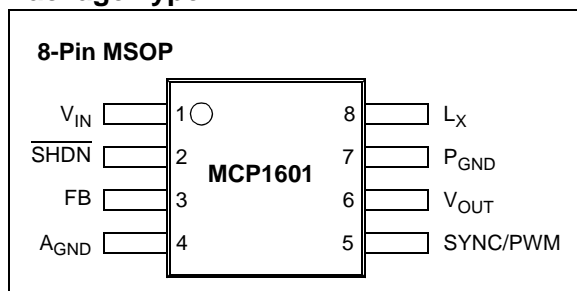

Description

The MCP1601 is a fully integrated synchronous BUCK (step down) DC/DC converter for battery powered systems. With an input operating range of 2.7V to 5.5V, the MCP1601 is ideal for applications being powered by one single cell Li-Ion, 2 to 3 cell NiMH, NiCd or alkaline sources. Output voltages can range from 0.9V to V_{IN} to accommodate a wide range of applications. Efficiency can exceed 92% while operating at 750 kHz with load current capability up to 500 mA. The MCP1601 is used to minimize space, cost and wasted energy.

The PWM mode switching frequency is internally set to a fixed 750 kHz allowing the use of low profile, surface mount inductors and ceramic capacitors while maintaining a typical efficiency of 92%.

The MCP1601 is capable of three distinct operating modes: PWM, PFM and Low Drop Out.

When operating in PWM (pulse width modulation) mode, the DC/DC converter switches at a single high frequency determined by either the internal 750 kHz oscillator or external synchronization frequency.

For applications that operate at very light to no load for extended periods of time, the MCP1601 is capable of operating in PFM (pulse frequency modulation mode) to reduce the number of switching cycles/sec and consume less energy.

The third mode of operation (LDO mode) occurs when the input voltage approaches the output voltage and the BUCK duty cycle approaches 100%. The MCP1601 will enter a low drop out mode and the high-side P-Channel BUCK switch will saturate, providing the output with the maximum voltage possible.

The MCP1601 has integrated over-current protection, over-temperature protection and UVLO (Under Voltage Lockout) to provide for a fail safe solution with no external components.

The MCP1601 is available in the 8-pin MSOP package, with an operating temperature range of -40°C to +85°C.

MCP1601

Typical Application

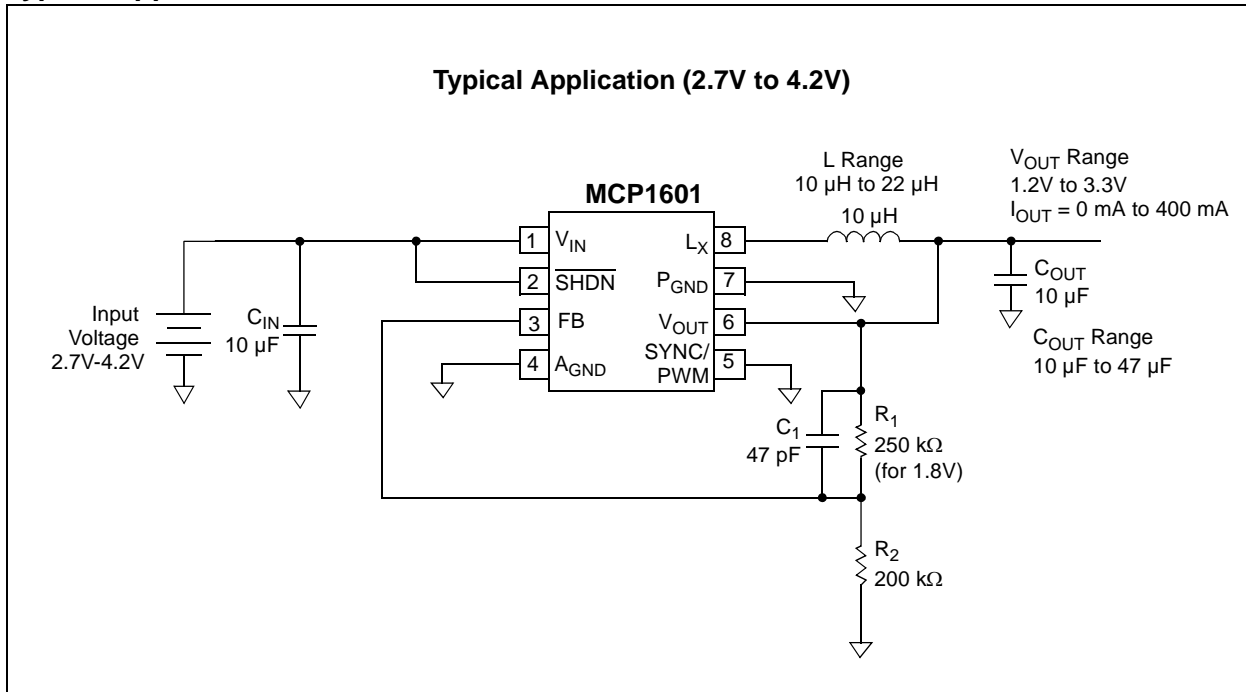

Functional Block Diagram

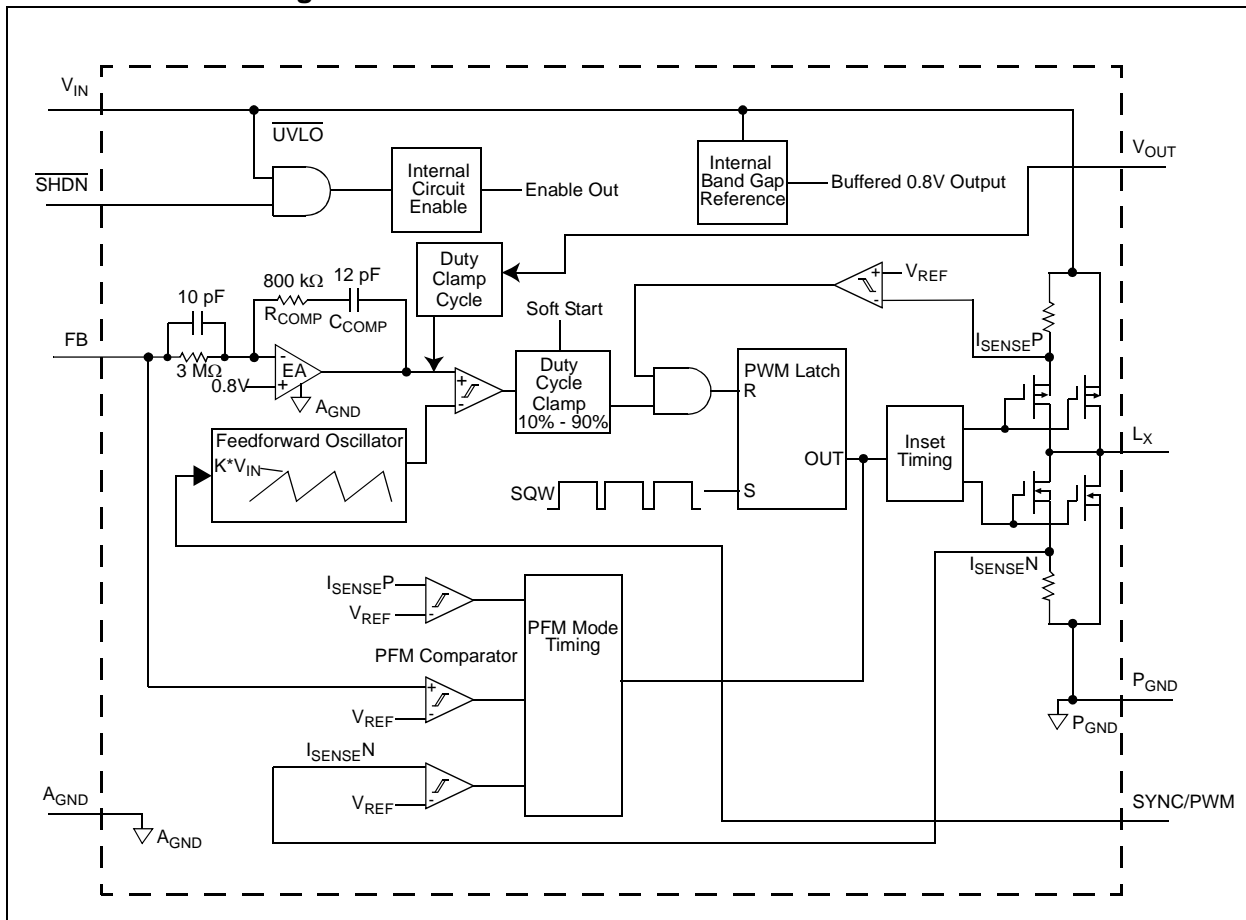

1.0 ELECTRICAL CHARACTERISTICS

Absolute Maximum Ratings †

$V_{IN} - A_{GND}$	6.0V
SHDN, FB, SYNC/PWM, V_{OUT} ($A_{GND}-0.3V$) to ($V_{IN}+0.3V$)	
L_X to P_{GND}	-0.3V to ($V_{IN}+0.3V$)
P_{GND} to A_{GND}	-0.3V to +0.3V
Output Short Circuit Current	continuous
Storage temperature	-65°C to +150°C
Ambient Temp. with Power Applied	-40°C to +85°C
Operating Junction Temperature.....	-40°C to +125°C
ESD protection on all pins.....	≥ 4 kV

† **Notice:** Stresses above those listed under "Maximum ratings" may cause permanent damage to the device. This is a stress rating only and functional operation of the device at those or any other conditions above those indicated in the operational listings of this specification is not implied. Exposure to maximum rating conditions for extended periods may affect device reliability.

PIN FUNCTION TABLE

NAME	FUNCTION
V_{IN}	Input Source Voltage
SHDN	Device Shutdown Pin
FB	Output Voltage Feedback Input
A_{GND}	Analog Ground
V_{OUT}	Sensed Output Voltage
SYNC/PWM	Synchronous Clock input or PWM/PFM select
P_{GND}	Power Ground
L_X	Output Inductor Node

ELECTRICAL SPECIFICATIONS

Electrical Specifications: Unless otherwise indicated, $V_{IN}=4.2V$, $V_{OUT}=1.8V$, $I_{LOAD} = 10$ mA, $T_A=-40^\circ C$ to $+85^\circ C$.						
Parameters	Sym	Min	Typ	Max	Units	Conditions
Power Input Requirements						
Voltage	V_{IN}	2.7	—	5.5	V	$I_{LOAD} = 0$ mA to 500 mA
Shutdown Current	$I(V_{IN})$	—	0.05	1.0	μA	Shutdown Mode ($\overline{SHDN} = GND$)
PFM Mode Current	$I(V_{IN})$	—	119	180	μA	SYNC/PWM = GND, PFM Mode ($I_{LOAD} = 0$ mA)
Oscillator Section						
Internal Oscillator Frequency	F_{OSC}	650	750	850	kHz	SYNC/PWM = V_{IN}
External Oscillator Capture Range	F_{SYNC}	850	—	1000	kHz	$F_{SYNC} > F_{OSC}$
External Oscillator Duty Cycle	$F_{SYN-FALL}$	10	—	90	%	$F_{SYNC} = 1$ MHz
Internal Power Switches						
R_{DSon} P-CHANNEL	R_{DSon-P}	—	500	—	m Ω	$I_P=100$ mA, $T_A=+25^\circ C$, $V_{IN}=4.2V$
R_{DSon} N-CHANNEL	R_{DSon-N}	—	500	—	m Ω	$I_N=100$ mA, $T_A=+25^\circ C$, $V_{IN}=4.2V$
Dropout Voltage	$V_{DROPOUT}$	—	250	—	mV	$V_{OUT} = 2.7V$, $I_{LOAD} = 300$ mA, $T_A=+25^\circ C$, $V_{DROPOUT}=97\%V_{OUT}$
Pin Leakage Current	I_{LX}	-1.0	—	1.0	μA	$\overline{SHDN} = 0V$, $V_{IN} = 5.5V$, $L_X = 0V$, $L_X = 5.5V$
Output PWM Mode						
Peak Current Limit	$I_{PEAK-PWM}$	—	1.0	—	A	PWM Mode, SYNC/PWM = V_{IN} , $T_A = +25^\circ C$
Output Voltage						
Output Voltage Range	V_{OUT}	0.9	—	V_{IN}	V	
Reference Feedback Voltage	V_{FB}	0.78	0.8	0.82	V	
Feedback Input Bias Current	I_{VFB}	—	0.1	—	nA	
Line Regulation	$V_{LINE-REG}$	—	0.1	—	%/V	$V_{IN}=2.7V$ to $5.5V$, $I_{LOAD}=10$ mA
Load Regulation	$V_{LOAD-REG}$	—	1.5	—	%	$V_{IN} = 3.6V$, $I_{LOAD} = 0$ mA to 300 mA
Start-Up Time	T_{START}	—	0.5	—	ms	PWM Mode, SYNC/PWM= V_{IN}

MCP1601

ELECTRICAL SPECIFICATIONS (CONTINUED)

Electrical Specifications: Unless otherwise indicated, $V_{IN}=4.2V$, $V_{OUT}=1.8V$, $I_{LOAD} = 10\text{ mA}$, $T_A=-40^{\circ}\text{C}$ to $+85^{\circ}\text{C}$.						
Parameters	Sym	Min	Typ	Max	Units	Conditions
Protection Features						
Average Short Circuit Current		—	890	—	mA	$R_{LOAD} < 1\text{ ohm}$
Under-Voltage Lockout	UVLO	2.4	—	2.7	V	For V_{IN} decreasing
Under-Voltage Lockout Hysteresis	UVLO _{HYS}	—	190	—	mV	
Thermal Shutdown	T_{SHD}	—	160	—	$^{\circ}\text{C}$	
Thermal Shutdown Hysteresis	$T_{SHD-HYS}$	—	10	—	$^{\circ}\text{C}$	
Interface Signals (SHDN, SYNC/PWM)						
Logic Low Input	$V_{IN-HIGH}$	—	—	15	% of V_{IN}	
Logic High Input	$V_{IN-HIGH}$	45	—	—	% of V_{IN}	
Input Leakage Current	I_{IN-LK}	—	—	0.1	μA	

TEMPERATURE SPECIFICATIONS

Electrical Specifications: Unless otherwise noted, all parameters apply at $V_{DD} = 2.7V$ to $5.5V$						
Parameters	Symbol	Min	Typ	Max	Units	Conditions
Temperature Ranges						
Specified Temperature Range	T_A	-40	—	+85	$^{\circ}\text{C}$	
Operating Junction Temperature Range	T_J	-40	—	+125	$^{\circ}\text{C}$	
Storage Temperature Range	T_A	-65	—	+150	$^{\circ}\text{C}$	
Thermal Package Resistances						
Thermal Resistance, 8 Pin MSOP	θ_{JA}	—	208	—	$^{\circ}\text{C/W}$	Single-Layer SEMI G42-88 Board, Natural Convection

2.0 TYPICAL PERFORMANCE CURVES

Note: The graphs and tables provided following this note are a statistical summary based on a limited number of samples and are provided for informational purposes only. The performance characteristics listed herein are not tested or guaranteed. In some graphs or tables, the data presented may be outside the specified operating range (e.g., outside specified power supply range) and therefore outside the warranted range.

Note: Unless otherwise indicated, $V_{IN} = 4.2V$, $V_{OUT} = 1.8V$, $L = 10 \mu H$, $C_{OUT} = 10 \mu F$ (X5R Ceramic), $C_{IN} = 10 \mu F$ (X5R Ceramic), $SYNC/PWM = V_{IN}$.

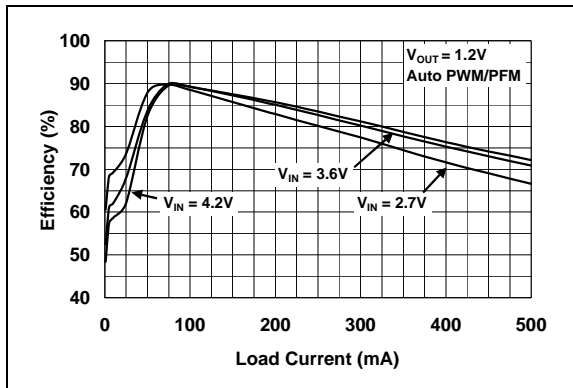

FIGURE 2-1: Efficiency vs. Load Current ($V_{OUT} = 1.2V$).

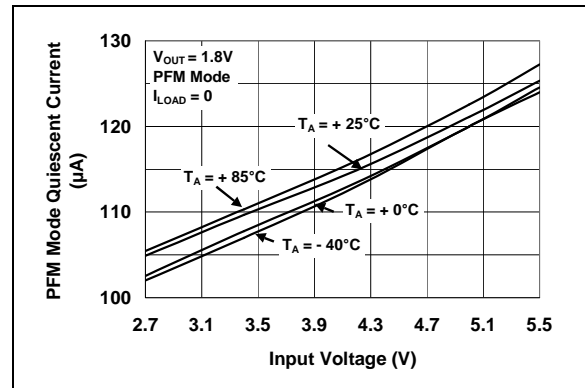

FIGURE 2-4: PFM Mode Quiescent Current vs. Input Voltage.

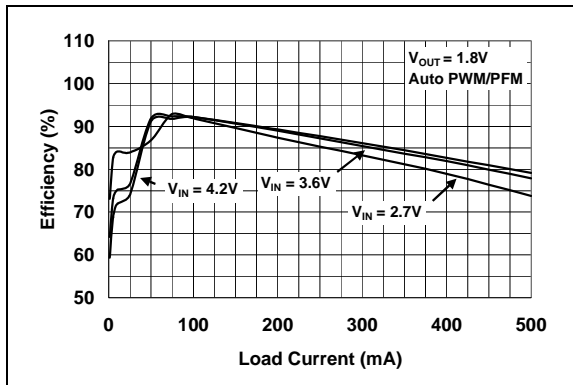

FIGURE 2-2: Efficiency vs. Load Current ($V_{OUT} = 1.8V$).

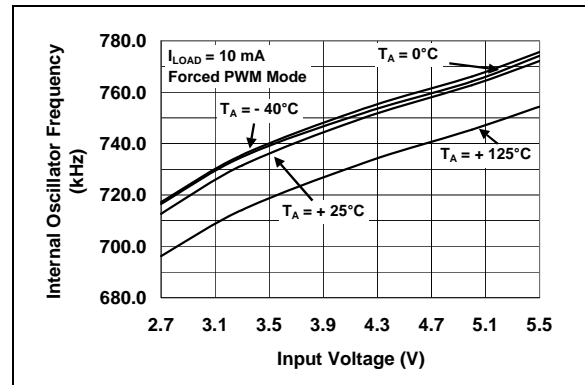

FIGURE 2-5: Oscillator Frequency vs. Input Voltage.

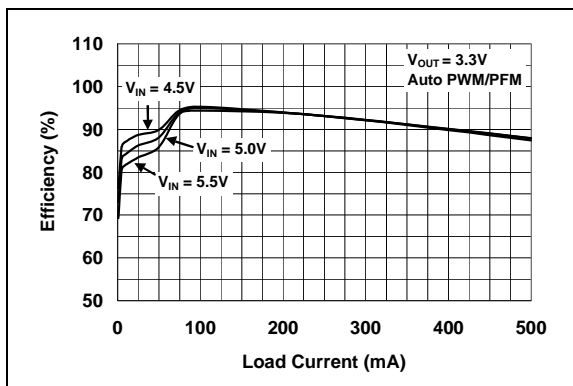

FIGURE 2-3: Efficiency vs. Load Current ($V_{OUT} = 3.3V$).

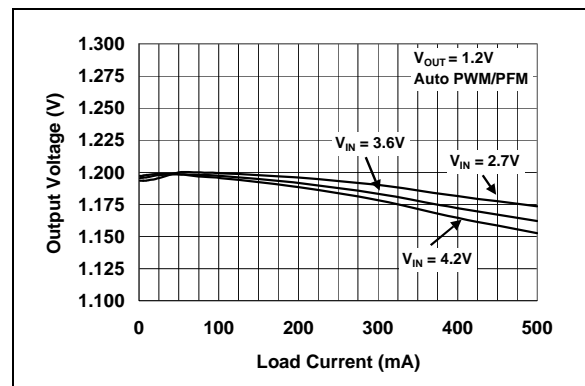

FIGURE 2-6: Output Voltage vs. Load Current.

MCP1601

Note: Unless otherwise indicated, $V_{IN} = 4.2V$, $V_{OUT} = 1.8V$, $L = 10 \mu H$, $C_{OUT} = 10 \mu F$ (X5R Ceramic), $C_{IN} = 10 \mu F$ (X5R Ceramic), $SYNC/PWM = V_{IN}$.

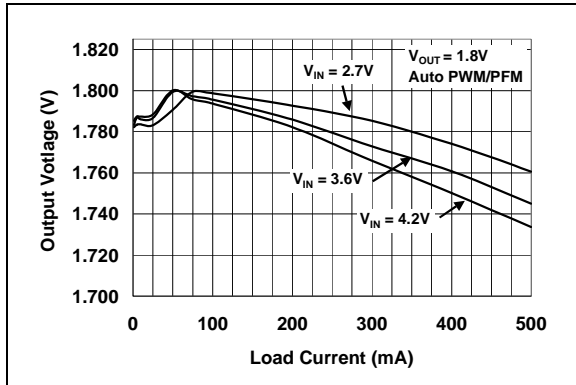

FIGURE 2-7: Output Voltage vs. Load Current.

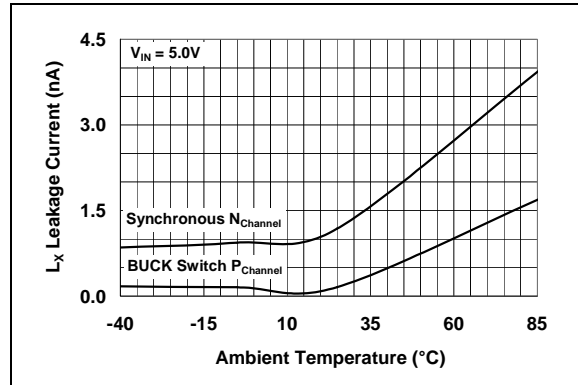

FIGURE 2-10: Switch Leakage vs. Temperature.

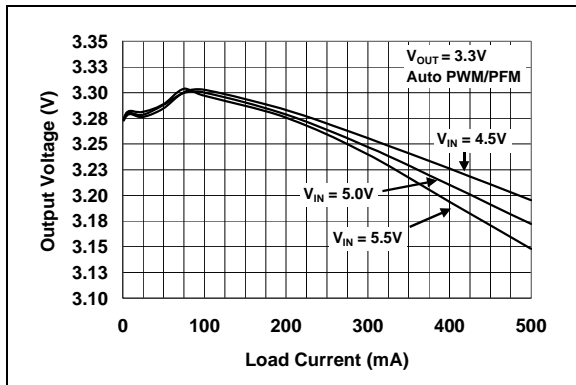

FIGURE 2-8: Output Voltage vs. Load Current.

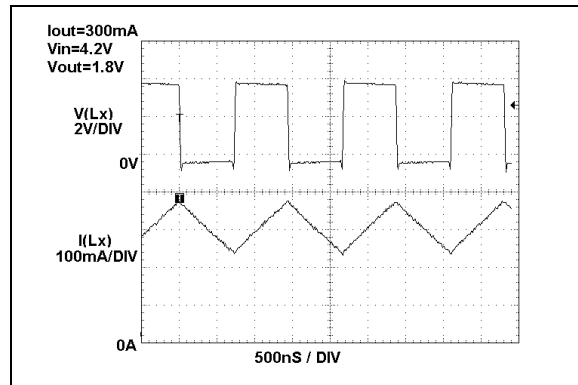

FIGURE 2-11: Typical PWM Mode of Operation Waveforms.

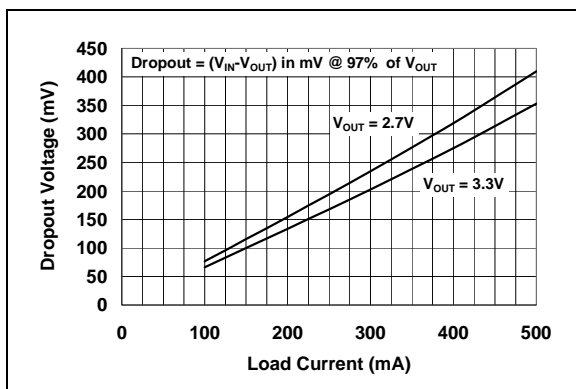

FIGURE 2-9: Input to Output Voltage Differential for 100% Duty Cycle vs. Load Current.

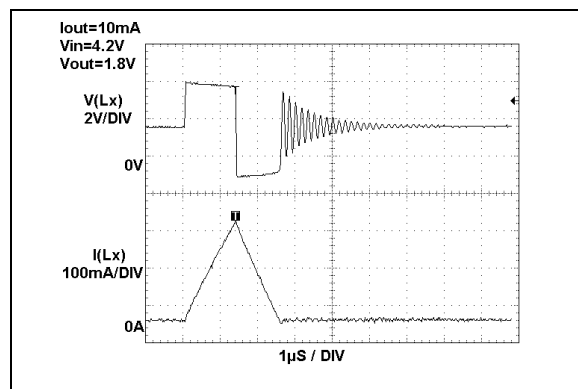

FIGURE 2-12: Typical PFM Mode of Operation Waveforms.

Note: Unless otherwise indicated, $V_{IN} = 4.2V$, $V_{OUT} = 1.8V$, $L = 10 \mu H$, $C_{OUT} = 10 \mu F$ (X5R Ceramic), $C_{IN} = 10 \mu F$ (X5R Ceramic), $SYNC/PWM = V_{IN}$.

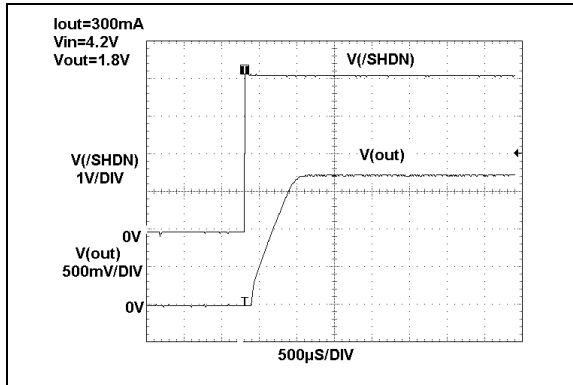

FIGURE 2-13: Typical Startup From Shutdown Waveform.

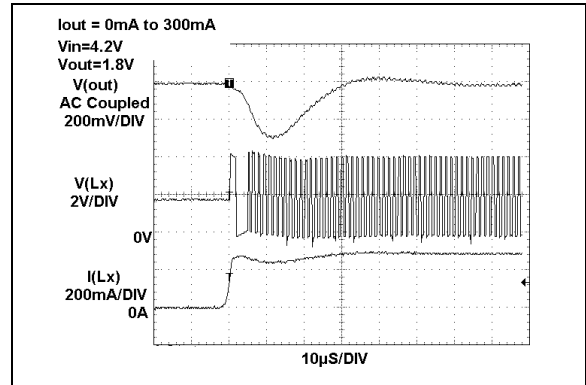

FIGURE 2-16: Load Step Response (PFM to PWM).

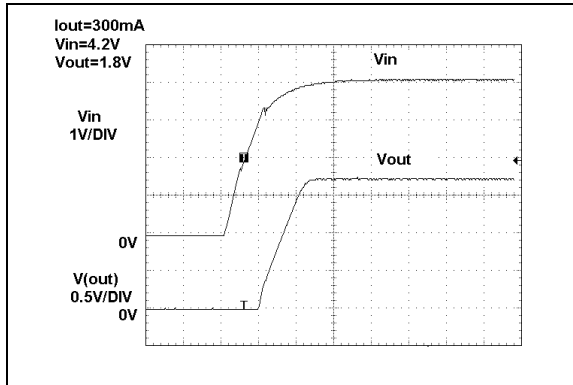

FIGURE 2-14: Startup From 0V Input.

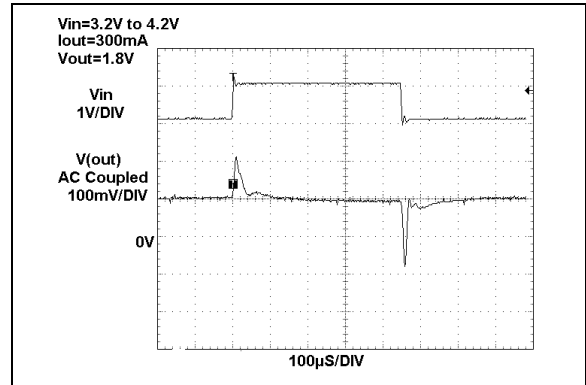

FIGURE 2-17: Line Step Response (Forced PWM).

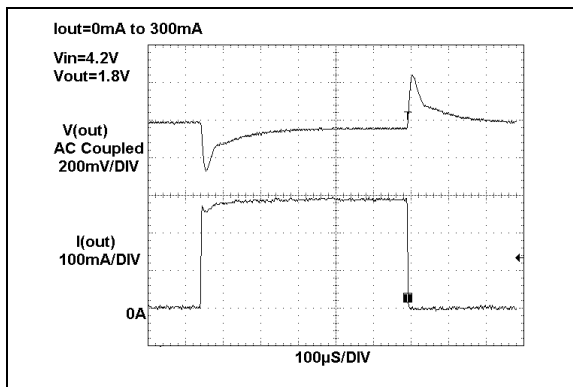

FIGURE 2-15: Load Step Response (Forced PWM).

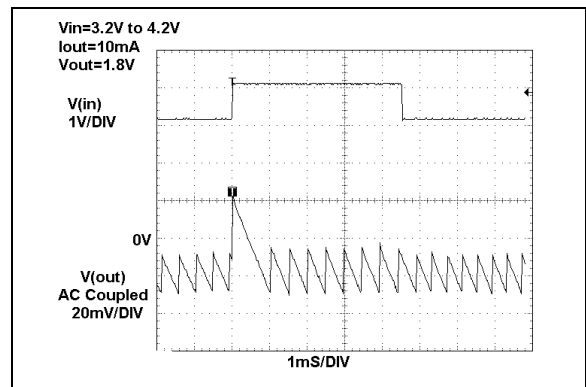

FIGURE 2-18: Line Step Response (PFM Mode).

MCP1601

Note: Unless otherwise indicated, $V_{IN} = 4.2V$, $V_{OUT} = 1.8V$, $L = 10 \mu H$, $C_{OUT} = 10 \mu F$ (X5R Ceramic), $C_{IN} = 10 \mu F$ (X5R Ceramic), $SYNC/PWM = V_{IN}$.

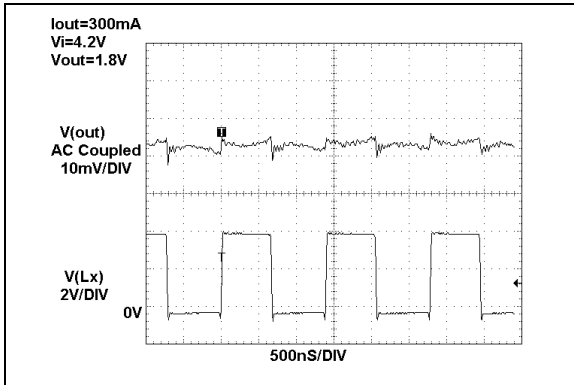

FIGURE 2-19: Typical Output Ripple Voltage (Forced PWM Mode).

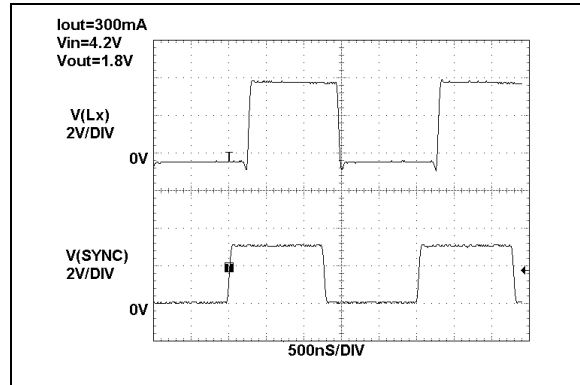

FIGURE 2-21: External Oscillator Synchronization.

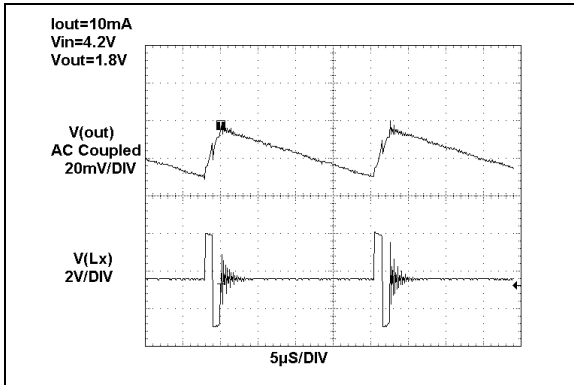

FIGURE 2-20: Typical Output Ripple Voltage (PFM Mode).

3.0 PIN FUNCTIONS

TABLE 3-1: PIN FUNCTION TABLE

Pin	Name	Function
1	V _{IN}	Input Voltage
2	$\overline{\text{SHDN}}$	Shutdown Input
3	FB	Feedback Input
4	A _{GND}	Analog Ground Return
5	SYNC/ PWM	Oscillator Synchronization or PWM/ PFM Select Mode Input
6	V _{OUT}	Sensed Output Voltage Input
7	P _{GND}	Power Ground Return
8	L _X	BUCK Inductor Output

3.1 Input Voltage (V_{IN})

Connect the unregulated input voltage source to V_{IN}. If the input voltage source is located more than several inches away, or is a battery, a typical input capacitor of 10 μ F is recommended.

3.2 Shutdown Input ($\overline{\text{SHDN}}$)

Connect $\overline{\text{SHDN}}$ to a logic low input to force the device into a shutdown low quiescent current mode. When in shutdown, both the P-Channel and N-Channel switches are turned off, in addition to the internal oscillator and other circuitry. When connected to a logic high input, the device will operate in the selected mode.

3.3 Feedback Input (FB)

Connect FB to an external resistor divider to set output voltage regulation. The feedback pin is typically equal to 0.8V. See Section 5.0, "Applications Information", for details in selecting feedback resistors.

3.4 Analog Ground Return (A_{GND})

Tie all small signal ground returns to A_{GND}. (See Section 5.6, "Printed Circuit Board Layout", for details).

3.5 Oscillator Synchronization or PWM/ PFM Select Mode Input (SYNC/PWM)

Connect an external oscillator to SYNC/PWM to synchronize. With an external oscillator present, the device is forced into a PWM-only mode of operation. For internal oscillator operation, the SYNC/PWM pin is tied high to operate in a forced PWM-only mode and low for a PWM/PFM mode of operation.

3.6 Output Voltage Sense (V_{OUT})

Connect the output voltage directly to V_{OUT} for sensing.

3.7 Power Ground Return (P_{GND})

Connect all large signal ground returns to P_{GND}. (See Section 5.6, "Printed Circuit Board Layout", for details).

3.8 BUCK Inductor Connection (L_X)

Connect L_X directly to the BUCK inductor. This pin carries large signal-level currents and all connections should be as short and wide as possible. (See Section 5.6, "Printed Circuit Board Layout", for details).

MCP1601

4.0 DEVICE OPERATION

The MCP1601 is a synchronous DC/DC converter with integrated switches. Developed to provide high efficiency across a wide line and load range, the MCP1601 integrates the three modes of operation described below. In addition to three operating modes, the MCP1601 also integrates many features that minimize external circuitry, saving board space and cost. With two external resistors used to set the output voltage, the MCP1601 output is adjustable from 0.9V to V_{IN} .

4.1 Operating Modes

The MCP1601 has three distinct modes of operation, with each one optimized for a specific operating condition commonly encountered in handheld portable power applications.

4.1.1 FEEDFORWARD VOLTAGE PULSE WIDTH MODULATION (PWM) MODE

The Pulse Width Modulation (PWM) mode of operation is desired when operating from typical to maximum output currents with the proper head room voltage at the input. This mode of operation optimizes efficiency and noise by switching at a fixed frequency. Typical output ripple voltage is less than 10 mV when using a 10 μ H inductor and 10 μ F ceramic capacitor. The internal operating frequency of the MCP1601 is 750 kHz, nominal. The duty cycle, or "ON" time, of the high-side, integrated, P-Channel MOSFET is determined by the continuous mode BUCK transfer function. For the continuous inductor current case, the duty cycle can be approximated by V_{OUT}/V_{IN} . The integrated high-side BUCK P-Channel switch will conduct for the "on" time. At the end of the "on" time, the high-side P-Channel switch is turned off and the integrated, low-side, N-Channel synchronous switch is turned on to freewheel the inductor current. The PWM mode architecture employed in the MCP1601 is a feedforward voltage mode control and feeds the input voltage into the PWM oscillator ramp. This information is used to quickly change the operating duty cycle in the event of a sudden input voltage change. The effects on the output voltage are minimized. To force the MCP1601 into PWM mode, the SYNC/PWM pin should be tied to a logic high. The forced PWM mode should be used for applications that require the fastest transient response from light load to heavy load or applications that require a single switching frequency independent of load.

An external oscillator between 850 kHz and 1 MHz can be connected to the SYNC/PWM pin for synchronization to an external clock source. The MCP1601 will always operate in the PWM mode when synchronized to an external oscillator.

4.1.2 PULSE FREQUENCY MODULATION (PFM) MODE

The MCP1601 is also capable of operating in a pulse frequency modulation mode. This mode of operation is desired for applications that have very long periods of inactivity and the output current requirement placed on the MCP1601 is very low. By entering the PFM mode of operation, the switching frequency becomes mainly a function of load current and will decrease as the load current decreases. By switching slower, the energy used turning "on" and "off" the high-side P-Channel and low-side N-Channel is reduced, making the PFM mode more efficient with light output load currents. When load activity is encountered, the MCP1601 will automatically switch from the PFM mode to the fixed frequency PWM mode by sensing the increase in load current. The auto PWM/PFM mode is selected by placing a logic low at the SYNC/PWM input pin. If an external clock is used to synchronize the MCP1601 switching frequency, the PFM mode is automatically disabled.

To enter the PFM mode of operation, the SYNC/PWM pin must be held to a logic low level and the peak inductor current, sensed internal to the MCP1601, is below the internal PFM threshold for more than 1024 clock cycles. If both of these conditions are met, the MCP1601 will enter the PFM mode. While in the PFM mode, the MCP1601 will disable the low-side N-Channel switch to optimize efficiency at low operating currents. A cycle will begin by turning on the high-side P-Channel switch and will end when the output voltage exceeds a predetermined voltage set point. If the peak inductor current exceeds the internal PFM mode current threshold prior to the output voltage exceeding the voltage set point, the load current has increased and the MCP1601 will automatically switch to PWM operation. The typical hysteresis on the PFM comparator is 6 mV. The typical output ripple voltage is below 40 mV when using a 10 μ H inductor and 10 μ F ceramic output capacitor when $V_{IN} = 4.2V$. For proper PFM mode operation, the value of the external inductor and the external capacitor should be the same. For example, when using a 10 μ H inductor, a 10 μ F capacitor should be used. When using a 22 μ H inductor, a 22 μ F capacitor should be used.

4.1.3 LOW DROP OUT (LDO) MODE

When the input voltage to the MCP1601 is decreasing and approaches the set output voltage level, the duty cycle increases to a maximum of 90% (typically). To continue to regulate the output to as high a voltage as possible, the MCP1601 enters the low drop out mode of operation. In this mode, the high-side P-Channel MOSFET acts like a saturated LDO. This mode allows the operation of the load circuitry down to the minimum input supply that is typical in battery-powered applications.

4.2 Cross-Conduction Timing

Proper timing between turning on the P-Channel, high-side MOSFET and turning off the N-Channel, low-side MOSFET (and vice versa) is critical to obtaining high efficiency. This delay between transitions is what limits the maximum duty cycle obtainable by the MCP1601. The delay between transitions leads to more time when the external inductor current is freewheeling through the internal N-Channel body diode and leads to a decrease in efficiency. If the timing delay is too short and both the internal P-Channel MOSFET and N-Channel MOSFET conduct, high peak currents will be observed shooting through the device. This will also reduce the operating efficiency. The MCP1601 inset timing is integrated to optimize efficiency for the entire line and load operating range of the device.

4.3 Integrated Protection Features

4.3.1 SHUTDOWN

By placing a logic low on the $\overline{\text{SHDN}}$ pin of the MCP1601, the device will enter a low quiescent current shutdown mode. This feature turns off all of the internal bias and drivers within the MCP1601 in an effort to minimize the quiescent current. This feature is popular for battery-operated, portable power applications. The shutdown low quiescent current is typically 1 μA .

4.3.2 INTERNAL OSCILLATOR AND SYNCHRONIZATION CAPABILITY

The internal oscillator is completely integrated and requires no external components. The frequency is set nominally to 750 kHz in an effort to minimize the external inductor and capacitor size needed for the BUCK topology. In addition to the internal 750 kHz oscillator, the MCP1601 is capable of being synchronized to an external oscillator. The external oscillator frequency must be greater than 850 kHz and less than 1 MHz. For proper synchronization, the duty cycle of the external synchronization clock must be between 10% and 90%. The minimum low voltage level should be below 15% of V_{IN} and the high level of the clock should be above 45% of V_{IN} . Rise and fall time requirements for the external synchronization clock must be faster than 100 ns from 10% to 90%. When synchronizing to an external clock, the MCP1601 will always operate in the PWM mode in an effort to eliminate multiple switching frequency's and their harmonics.

4.3.3 INTERNAL SOFT START

The MCP1601 completely integrates the soft start function and requires no external components. The soft start time is typically 0.5 ms and is reset during over-current and over-temperature shutdown.

4.3.4 OVER-TEMPERATURE PROTECTION

The MCP1601 protects the internal circuitry from over-temperature conditions by sensing the internal device temperature and shutting down when it reaches approximately 160°C. The device will shut down, the temperature will cool to approximately 150°C, soft start will be enabled and normal operation will resume with no external circuit intervention.

4.3.5 UNDER-VOLTAGE LOCKOUT

Protection from operating at sustained input voltages that are out of range is prevented with the integrated Under-Voltage Lockout feature. When the input voltage dips below 2.5V (typically), the MCP1601 will shutdown and the soft start circuit will be reset. Normal operation will resume when the input voltage is elevated above 2.7V, maximum. This hysteresis is provided to prevent the device from starting with too low of an input voltage.

MCP1601

5.0 APPLICATIONS INFORMATION

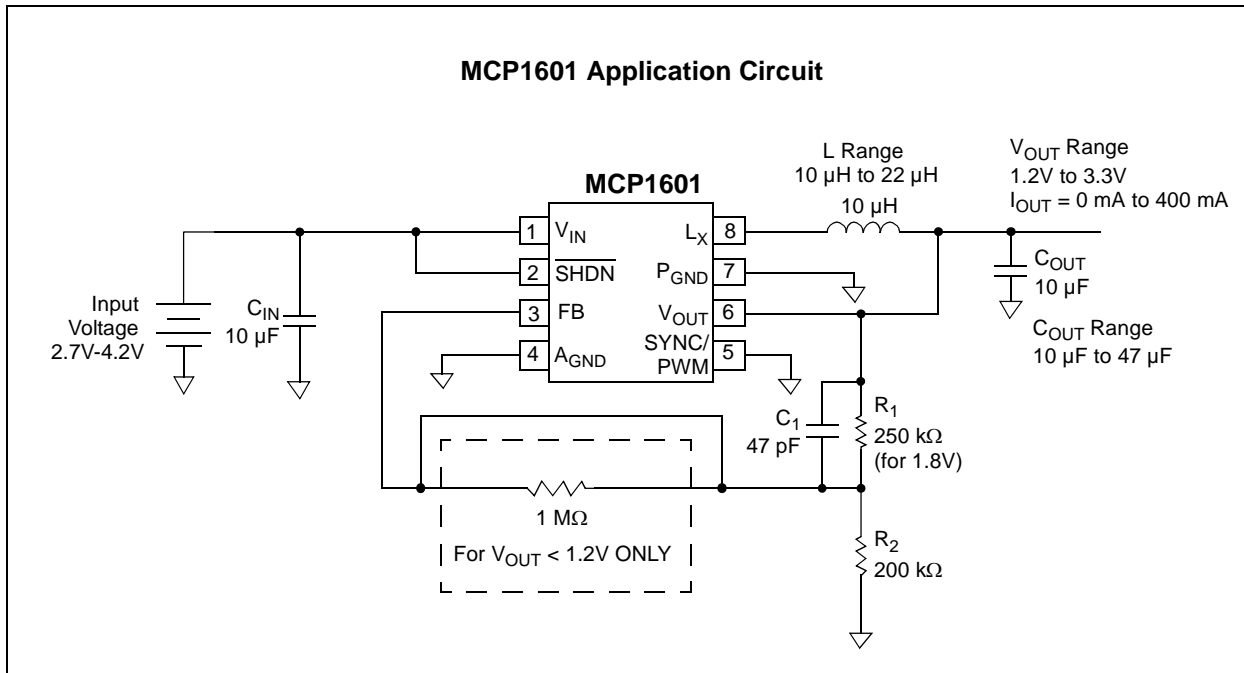

FIGURE 5-1: Typical Application Circuit.

5.1 Setting Output Voltage

The MCP1601 output voltage is set by using two external resistors for output voltages $\geq 1.2\text{V}$. For output voltages $< 1.2\text{V}$, a third $1\text{M}\Omega$ series resistor is necessary to compensate the control system. A $200\text{k}\Omega$ resistor is recommended for R_2 , the lower end of the voltage divider. Using higher value resistors will make the circuit more susceptible to noise on the FB pin, causing unstable operation. Lower value resistors can be used down to $20\text{k}\Omega$ or below, if necessary.

The feedback reference voltage for the MCP1601 is typically 0.8V . The equation used to calculate the output voltage is shown below.

EQUATION

$$R_1 = R_2 \times [(V_{OUT}/V_{FB}) - 1]$$

Where: V_{OUT} is the desired output voltage,
 V_{FB} is the MCP1601 internal feedback reference voltage
 R_1 is the resistor connected to V_{OUT} in the voltage divider
 R_2 is the resistor connected to ground in the voltage divider

Example:

Desired $V_{OUT} = 2.5\text{V}$

$V_{FB} = 0.8\text{V}$

$R_2 = 200\text{k}\Omega$

$R_1 = 425\text{k}\Omega$

5.1.1 LEAD CAPACITOR

Capacitor C_1 is used for applications that utilize ceramic output capacitors. To lower the PFM mode ripple voltage, a 47pF capacitor for C_1 is used to couple the output AC ripple voltage to the internal PFM mode comparator. For PWM mode, only applications that use electrolytic capacitors that have 0.2Ω or greater of ESR (Equivalent Series Resistance), C_1 is not necessary.

5.2 Choosing External Components

5.2.1 CAPACITORS

The MCP1601 was developed to take full advantage of the latest ceramic capacitor technology, though electrolytic types can be used as well. When selecting the best capacitor for the application, the capacitance, physical size, ESR, temperature coefficient, ripple current ratings (electrolytic) and cost are considered in making the best choice.

When selecting ceramic capacitors for C_{OUT} , the temperature coefficient of the dielectric should be evaluated. Two dielectrics are recommended as they are stable over a wide temperature range (X5R and X7R). Other dielectrics can be used, but their capacitance should stay within the recommended range over the entire operating temperature range.

5.2.1.1 Input

For all BUCK-derived topologies, the input current is pulled from the source in pulses, placing some burden on the input capacitor. For most applications, a 10 μF ceramic capacitor connected to the MCP1601 input is recommended to filter the current pulses. Less capacitance can be used for applications that have low source impedance. The ripple current ratings for ceramic capacitors are typically very high due to their low loss characteristics. Lower-cost electrolytic capacitors can be used, but ripple current ratings should not be exceeded.

5.2.1.2 Output

For BUCK-derived topologies, the output capacitor filters the continuous AC inductor ripple current while operating in the PWM mode. Typical inductor AC ripple current for the MCP1601 is 120 mA peak-to-peak with a 3.6V input, 10 μH inductor for a 1.8V output application. Using an output capacitor with 0.3 Ω of ESR, the output ripple will be approximately 36 mV.

The recommended range for the output capacitor is from 10 μF ($\pm 20\%$) to 47 μF ($\pm 20\%$). Larger value capacitors can be used, but require evaluation of the control system stability.

EQUATION

$$V_{Ripple} = I_{LRipple} \times C_{OUTesr}$$

The above equation assumes that the output capacitance is large enough so that the ripple voltage (as a result of charging and discharging the capacitor) is negligible and can be used for applications that use electrolytic capacitors with $esr > 0.3\Omega$.

When using a 10 μF ceramic X5R dielectric capacitor, the output ripple voltage is typically less than 10 mV.

5.2.2 BUCK INDUCTOR

There are many suppliers and choices for selecting the BUCK inductor. The application, physical size requirements (height vs. area), current rating, resistance, mounting method, temperature range, minimum inductance and cost all need to be considered in making the best choice.

When choosing an inductor for the MCP1601 Synchronous BUCK, there are two primary electrical specifications to consider.

1. Current rating of the inductor.
2. Resistance of the inductor.

When selecting a BUCK inductor, many suppliers specify a maximum peak current.

The maximum peak inductor current is equal to the maximum DC output current plus 1/2 the peak-to-peak AC ripple current in the inductor. The AC ripple current in the inductor can be calculated using the following relationship.

EQUATION

$$V_L = L \times \frac{dI}{dt}$$

Solving for ΔI_L :

EQUATION

$$\Delta I_L = (V_L / L) \times \Delta t$$

Where: Δt is equal to the "on" time of the P-Channel switch and,
 V_L = the voltage across the inductor
 $(V_{IN} - V_{OUT})$

Example:

$$V_{IN} = 3.6\text{V}$$

$$V_{OUT} = 1.8\text{V}$$

$$F_{SW} = 750\text{ kHz}$$

$$I_{OUT(MAX)} = 300\text{ mA}$$

The approximate "on" time is equal to the Duty Cycle $(V_{OUT} / V_{IN}) \times 1 / F_{SW}$.

$$T_{ON} = (1.8\text{V} / 3.6\text{V}) \times 1 / (750\text{ kHz})$$

$$T_{ON} = 667\text{ ns}$$

$$V_L = 3.6\text{V} - 1.8\text{V} = 1.8\text{V}$$

$$\Delta I_L = (1.8\text{V} / 10\ \mu\text{H}) \times 667\text{ ns}$$

$$\Delta I_L = 120\text{ mA}$$

$$I_{L(PEAK)} = I_{OUTMAX} + 1/2 \Delta I_L$$

$$I_{L(PEAK)} = 300\text{ mA} + (120\text{ mA}) / 2$$

$$I_{L(PEAK)} = 360\text{ mA}$$

Many suppliers of inductors rate the maximum RMS (Root Mean Square) current. The BUCK inductor RMS current is dependent on the output current, inductance, input voltage, output voltage and switching frequency. For the MCP1601, the inductor RMS current over the 2.7V to 5.5V input range, 0.9V to 5V output voltage range is no more than 15% higher than the average DC output current for the minimum recommended inductance of 10 $\mu\text{H} \pm 20\%$. When selecting an inductor that has a maximum RMS current rating, use a simple approximation that the RMS current is 1.2 times the maximum output current.

Example:

$I_{OUT(MAX)} = 300\text{ mA}$, the inductor should have an RMS rating $> 360\text{ mA}$ ($1.2 \times I_{OUT(MAX)}$).

MCP1601

DC resistance is another common inductor specification. The MCP1601 will work properly with inductor DC resistance down to 0Ω . The trade-off in selecting an inductor with low DC resistance is size and cost. To lower the resistance, larger wire is used to wind the inductor. The switch resistance in the MCP1601 is approximately 0.5Ω . Inductors with DC resistance lower than 0.1Ω will not have a significant impact on the efficiency of the converter.

5.3 L and C_{OUT} Combinations

When selecting the L-C_{OUT} output filter components, the inductor value range is limited from $10\mu\text{H}$ to $22\mu\text{H}$. However, when using the larger inductor values, larger capacitor values should be used. The following table lists the recommended combinations of L and C_{OUT}.

TABLE 5-1: L-C_{OUT} COMBINATIONS

L	C _{OUT}
$10\mu\text{H}$	$10\mu\text{F}$ to $47\mu\text{F}$
$15\mu\text{H}$	$15\mu\text{F}$ to $47\mu\text{F}$
$22\mu\text{H}$	$22\mu\text{F}$ to $47\mu\text{F}$

Note: For proper PFM mode operation, the value of the external inductor and the external capacitor should be the same. For example, when using a $10\mu\text{H}$ inductor, a $10\mu\text{F}$ capacitor should be used. When using a $22\mu\text{H}$ inductor, a $22\mu\text{F}$ capacitor should be used.

5.4 Passive Component Suppliers

TABLE 5-2: CERAMIC CAPACITOR SUPPLIERS

Supplier	Type	Description
Murata [®]	Ceramic	$10\mu\text{F}$ 0805 X5R 6.3V #GRM21BR60J106K
Murata [®]	Ceramic	$10\mu\text{F}$ 1206 X5R 6.3V #GRM319R60J106K
Taiyo Yuden [™]	Ceramic	$10\mu\text{F}$ 1210 X5R 6.3V JMK325BJ106MD
AVX [™]	Ceramic	$10\mu\text{F}$ 0805 X5R 6.3V #08056D106MAT4A
AVX [™]	Ceramic	$10\mu\text{F}$ 1206 X5R 6.3V #12066D106MAT4A
Kemet [®]	Ceramic	$10\mu\text{F}$ 1210 6.3V #C1210C106M9PAC
Murata [®]	Ceramic	$22\mu\text{F}$ 1206 X5R 6.3V GRM31CR60J226ME20B
Taiyo Yuden [™]	Ceramic	$22\mu\text{F}$ 1210 X5R 6.3V JMK325BJ226MY

Note: Taiyo Yuden 1210 is a low profile case (1.15 mm)

TABLE 5-3: ELECTROLYTIC CAPACITOR SUPPLIERS

Supplier	Type	Description
Kemet [®]	Tantalum	$47\mu\text{F}$ D Case 200 M Ω 10V #T495D476M010AS
AVX [™]	Tantalum	$47\mu\text{F}$ C Case 300 M Ω 6.3V #TPSC476M006S300
Sprague [®]	Tantalum	$47\mu\text{F}$ C Case 110 M Ω 16V 594D47X0016C2T
Sprague [®]	Tantalum	$22\mu\text{F}$ B Case 380 M Ω 6.3V 594D226X06R3B2T
Sprague [®]	Tantalum	$15\mu\text{F}$ B Case 500 M Ω 10V 594D156X0010B2T

TABLE 5-4: INDUCTOR SUPPLIERS

Supplier	L	Type	Area (mm)	Height (mm)	DC Resistance	Max. Current	Series
Sumida®	10 µH	Unshielded	4.1 mm x 3.8 mm	3.0 mm	230 MΩ	0.76A	C32
Sumida®	10 µH	Shielded	4.0 mm x 4.0 mm	1.8 mm	160 MΩ	0.66A	CDRH3D16
Sumida®	10 µH	Shielded	5.7 mm x 5.7 mm	3.0 mm	65 MΩ	1.3A	CDRH5D28
CT*	10 µH	Shielded	7.3 mm x 7.3 mm	3.5 mm	70 MΩ	1.7A	CTCDRH73
Coilcraft®	10 µH	Shielded	6.6 mm x 4.5 mm	3.0 mm	75 MΩ	1.0A	DS1608
Coilcraft®	15 µH	Shielded	6.6 mm x 4.5 mm	3.0 mm	90 MΩ	0.8A	DS1608
Coilcraft®	22 µH	Shielded	6.6 mm x 4.5 mm	3.0 mm	110 MΩ	0.7A	DS1608
Coilcraft®	10 µH	Unshielded Wafer	6.0 mm x 5.4 mm	1.3 mm	300 MΩ	0.60A	LPO6013
Coilcraft®	15 µH	Unshielded Wafer	6.0 mm x 5.4 mm	1.3 mm	380 MΩ	0.55A	LPO6013
Taiyo Yuden™	10 µH	Shielded	5.0 mm x 5.0 mm	2.0 mm	66 MΩ	0.7A	NP04SB100M

Note: CT* = Central Technologies

5.5 Efficiency

Efficiency will be affected by the external component selection and the specific operating conditions for the application. In Section 2.0, “Typical Performance Curves”, there are curves plotted using typical inductors that can be used to estimate the converter efficiency for 1.2V, 1.8V and 3.3V.

5.6 Printed Circuit Board Layout

The MCP1601 is capable of switching over 500 mA at 750 kHz. As with all high-frequency, switch mode, power supplies, a good board layout is essential to preventing the noise generated by the power train switching from interfering with the sensing circuitry. The MCP1601 has not demonstrated a sensitivity to layout, but good design practice will prevent undesired results.

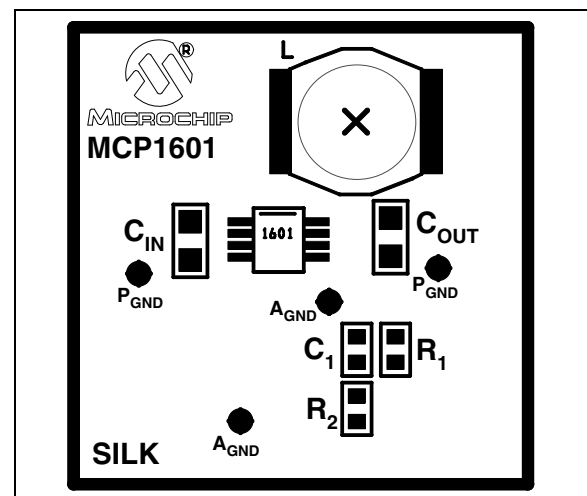

FIGURE 5-2: Component Placement.

When designing a board layout for the MCP1601, the first thing to consider is the physical placement of the external components. In Figure 5-2, SM0805 10 µF ceramic capacitors are used for C_{IN} and C_{OUT}. The SM0603 package is used for R₁, R₂ and C₁. The inductor used is the Coilcraft® LPO2506 series low profile (0.047” high). The board outline in this example is 1” x 1”. C_{IN}, L and C_{OUT} are positioned around the MCP1601 to make the high current paths as short as possible.

MCP1601

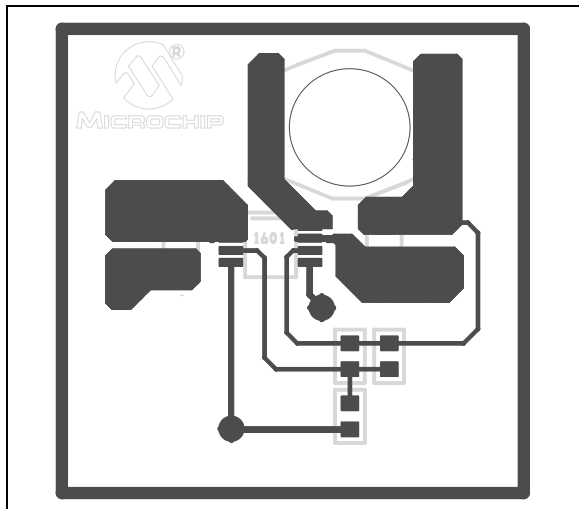

FIGURE 5-3: Top Layer.

The top layer of the board layout is shown in Figure 5-3. The power conversion process is made up of two types of circuits. One circuit carries changing large signals (current, voltage), like C_{IN} , C_{OUT} , L and the V_{IN} , L_X P_{GND} pins of the MCP1601. The other circuitry is much smaller in signal and is used to sense, regulate and control the high-power circuitry. These components are R_1 , R_2 , C_1 and pins FB , A_{GND} . The top layer is partitioned so that the larger signal connections are short and wide, while the smaller signals are routed away from the large signals.

The MCP1601 utilizes two ground pins to separate the large signal ground current from the small signal circuit ground. The large signal (“Power Ground”) is labeled “ P_{GND} ”. The small signal is labeled “Analog Ground” or “ A_{GND} ”. In Figure 5-3, the P_{GND} and the A_{GND} are kept separate on the top layer.

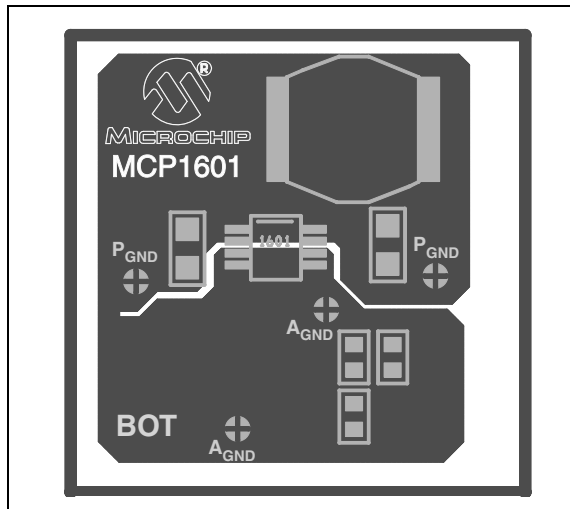

FIGURE 5-4: Bottom Layer.

In Figure 5-4, the bottom layer is a partitioned ground plane that connects A_{GND} to P_{GND} near the input capacitor. The large signal current will circulate on the top P_{GND} partition. The lower partition is used for a “quiet” ground, where A_{GND} is connected.

6.0 PACKAGING INFORMATION

6.1 Package Marking Information

8-Lead MSOP

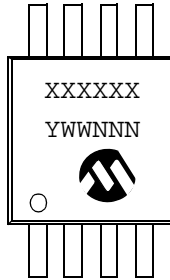

Example:

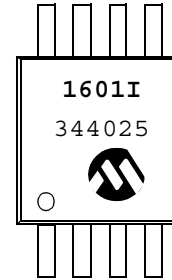

Legend:	XX...X	Customer-specific information
	Y	Year code (last digit of calendar year)
	YY	Year code (last 2 digits of calendar year)
	WW	Week code (week of January 1 is week '01')
	NNN	Alphanumeric traceability code
	(e3)	Pb-free JEDEC designator for Matte Tin (Sn)
	*	This package is Pb-free. The Pb-free JEDEC designator (e3) can be found on the outer packaging for this package.

Note: In the event the full Microchip part number cannot be marked on one line, it will be carried over to the next line, thus limiting the number of available characters for customer-specific information.

MCP1601

8-Lead Plastic Micro Small Outline Package (MS) (MSOP)

Note: For the most current package drawings, please see the Microchip Packaging Specification located at <http://www.microchip.com/packaging>

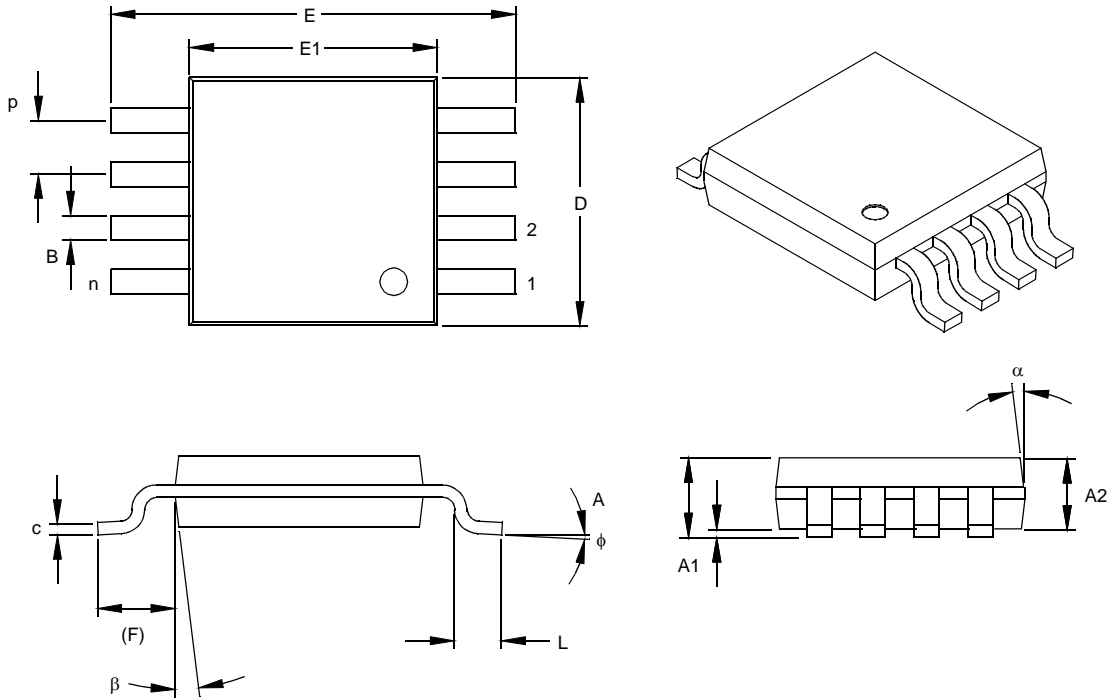

Units		INCHES			MILLIMETERS*		
Dimension Limits		MIN	NOM	MAX	MIN	NOM	MAX
Number of Pins	n		8				8
Pitch	p	.026			0.65		
Overall Height	A			.044			1.18
Molded Package Thickness	A2	.030	.034	.038	0.76	0.86	0.97
Standoff §	A1	.002		.006	0.05		0.15
Overall Width	E	.184	.193	.200	4.67	4.90	5.08
Molded Package Width	E1	.114	.118	.122	2.90	3.00	3.10
Overall Length	D	.114	.118	.122	2.90	3.00	3.10
Foot Length	L	.016	.022	.028	0.40	0.55	0.70
Footprint (Reference)	F	.035	.037	.039	0.90	0.95	1.00
Foot Angle	φ	0		6	0		6
Lead Thickness	c	.004	.006	.008	0.10	0.15	0.20
Lead Width	B	.010	.012	.016	0.25	0.30	0.40
Mold Draft Angle Top	α		7			7	
Mold Draft Angle Bottom	β		7			7	

*Controlling Parameter
§ Significant Characteristic

Notes:

Dimensions D and E1 do not include mold flash or protrusions. Mold flash or protrusions shall not exceed .010" (0.254mm) per side.

Drawing No. C04-111

7.0 REVISION HISTORY

Revision B (January 2013)

Added a note to each package outline drawing.

MCP1601

NOTES:

PRODUCT IDENTIFICATION SYSTEM

To order or obtain information, e.g., on pricing or delivery, refer to the factory or the listed sales office.

<u>PART NO.</u>	<u>X</u>	<u>/XX</u>
Device	Temperature Range	Package
Device:	MCP1601: 500 mA Synchronous BUCK Regulator MCP1601T: 500 mA Synchronous BUCK Regulator Tape and Reel	
Temperature Range:	I = -40°C to +85°C	
Package:	MS = Plastic Micro Small Outline (MSOP), 8-lead	

Examples:

- a) MCP1601-I/MS: 8LD MSOP package.
- b) MCP1601T-I/MS: Tape and Reel, 8LD MSOP package.

Sales and Support

Data Sheets

Products supported by a preliminary Data Sheet may have an errata sheet describing minor operational differences and recommended workarounds. To determine if an errata sheet exists for a particular device, please contact one of the following:

1. Your local Microchip sales office
2. The Microchip Worldwide Site (www.microchip.com)

Please specify which device, revision of silicon and Data Sheet (include Literature #) you are using.

Customer Notification System

Register on our web site (www.microchip.com/cn) to receive the most current information on our products.

MCP1601

NOTES:

Note the following details of the code protection feature on Microchip devices:

- Microchip products meet the specification contained in their particular Microchip Data Sheet.
- Microchip believes that its family of products is one of the most secure families of its kind on the market today, when used in the intended manner and under normal conditions.
- There are dishonest and possibly illegal methods used to breach the code protection feature. All of these methods, to our knowledge, require using the Microchip products in a manner outside the operating specifications contained in Microchip's Data Sheets. Most likely, the person doing so is engaged in theft of intellectual property.
- Microchip is willing to work with the customer who is concerned about the integrity of their code.
- Neither Microchip nor any other semiconductor manufacturer can guarantee the security of their code. Code protection does not mean that we are guaranteeing the product as “unbreakable.”

Code protection is constantly evolving. We at Microchip are committed to continuously improving the code protection features of our products. Attempts to break Microchip's code protection feature may be a violation of the Digital Millennium Copyright Act. If such acts allow unauthorized access to your software or other copyrighted work, you may have a right to sue for relief under that Act.

Information contained in this publication regarding device applications and the like is provided only for your convenience and may be superseded by updates. It is your responsibility to ensure that your application meets with your specifications. MICROCHIP MAKES NO REPRESENTATIONS OR WARRANTIES OF ANY KIND WHETHER EXPRESS OR IMPLIED, WRITTEN OR ORAL, STATUTORY OR OTHERWISE, RELATED TO THE INFORMATION, INCLUDING BUT NOT LIMITED TO ITS CONDITION, QUALITY, PERFORMANCE, MERCHANTABILITY OR FITNESS FOR PURPOSE. Microchip disclaims all liability arising from this information and its use. Use of Microchip devices in life support and/or safety applications is entirely at the buyer's risk, and the buyer agrees to defend, indemnify and hold harmless Microchip from any and all damages, claims, suits, or expenses resulting from such use. No licenses are conveyed, implicitly or otherwise, under any Microchip intellectual property rights.

Trademarks

The Microchip name and logo, the Microchip logo, dsPIC, FlashFlex, KEELOQ, KEELOQ logo, MPLAB, PIC, PICmicro, PICSTART, PIC³² logo, rPIC, SST, SST Logo, SuperFlash and UNI/O are registered trademarks of Microchip Technology Incorporated in the U.S.A. and other countries.

FilterLab, Hampshire, HI-TECH C, Linear Active Thermistor, MTP, SEEVAL and The Embedded Control Solutions Company are registered trademarks of Microchip Technology Incorporated in the U.S.A.

Silicon Storage Technology is a registered trademark of Microchip Technology Inc. in other countries.

Analog-for-the-Digital Age, Application Maestro, BodyCom, chipKIT, chipKIT logo, CodeGuard, dsPICDEM, dsPICDEM.net, dsPICworks, dsSPEAK, ECAN, ECONOMONITOR, FanSense, HI-TIDE, In-Circuit Serial Programming, ICSP, Mindi, MiWi, MPASM, MPF, MPLAB Certified logo, MPLIB, MPLINK, mTouch, Omniclient Code Generation, PICC, PICC-18, PICDEM, PICDEM.net, PICkit, PICtail, REAL ICE, rLAB, Select Mode, SQI, Serial Quad I/O, Total Endurance, TSHARC, UniWinDriver, WiperLock, ZENA and Z-Scale are trademarks of Microchip Technology Incorporated in the U.S.A. and other countries.

SQTP is a service mark of Microchip Technology Incorporated in the U.S.A.

GestIC and ULPP are registered trademarks of Microchip Technology Germany II GmbH & Co. & KG, a subsidiary of Microchip Technology Inc., in other countries.

All other trademarks mentioned herein are property of their respective companies.

© 2003-2013, Microchip Technology Incorporated, Printed in the U.S.A., All Rights Reserved.

 Printed on recycled paper.

ISBN: 9781620768990

QUALITY MANAGEMENT SYSTEM
CERTIFIED BY DNV
== ISO/TS 16949 ==

Microchip received ISO/TS-16949:2009 certification for its worldwide headquarters, design and wafer fabrication facilities in Chandler and Tempe, Arizona; Gresham, Oregon and design centers in California and India. The Company's quality system processes and procedures are for its PIC[®] MCUs and dsPIC[®] DSCs, KEELOQ[®] code hopping devices, Serial EEPROMs, microperipherals, nonvolatile memory and analog products. In addition, Microchip's quality system for the design and manufacture of development systems is ISO 9001:2000 certified.



MICROCHIP

Worldwide Sales and Service

AMERICAS

Corporate Office
2355 West Chandler Blvd.
Chandler, AZ 85224-6199
Tel: 480-792-7200
Fax: 480-792-7277
Technical Support:
<http://www.microchip.com/support>
Web Address:
www.microchip.com

Atlanta
Duluth, GA
Tel: 678-957-9614
Fax: 678-957-1455

Boston
Westborough, MA
Tel: 774-760-0087
Fax: 774-760-0088

Chicago
Itasca, IL
Tel: 630-285-0071
Fax: 630-285-0075

Cleveland
Independence, OH
Tel: 216-447-0464
Fax: 216-447-0643

Dallas
Addison, TX
Tel: 972-818-7423
Fax: 972-818-2924

Detroit
Farmington Hills, MI
Tel: 248-538-2250
Fax: 248-538-2260

Indianapolis
Noblesville, IN
Tel: 317-773-8323
Fax: 317-773-5453

Los Angeles
Mission Viejo, CA
Tel: 949-462-9523
Fax: 949-462-9608

Santa Clara
Santa Clara, CA
Tel: 408-961-6444
Fax: 408-961-6445

Toronto
Mississauga, Ontario,
Canada
Tel: 905-673-0699
Fax: 905-673-6509

ASIA/PACIFIC

Asia Pacific Office
Suites 3707-14, 37th Floor
Tower 6, The Gateway
Harbour City, Kowloon
Hong Kong
Tel: 852-2401-1200
Fax: 852-2401-3431

Australia - Sydney
Tel: 61-2-9868-6733
Fax: 61-2-9868-6755

China - Beijing
Tel: 86-10-8569-7000
Fax: 86-10-8528-2104

China - Chengdu
Tel: 86-28-8665-5511
Fax: 86-28-8665-7889

China - Chongqing
Tel: 86-23-8980-9588
Fax: 86-23-8980-9500

China - Hangzhou
Tel: 86-571-2819-3187
Fax: 86-571-2819-3189

China - Hong Kong SAR
Tel: 852-2943-5100
Fax: 852-2401-3431

China - Nanjing
Tel: 86-25-8473-2460
Fax: 86-25-8473-2470

China - Qingdao
Tel: 86-532-8502-7355
Fax: 86-532-8502-7205

China - Shanghai
Tel: 86-21-5407-5533
Fax: 86-21-5407-5066

China - Shenyang
Tel: 86-24-2334-2829
Fax: 86-24-2334-2393

China - Shenzhen
Tel: 86-755-8864-2200
Fax: 86-755-8203-1760

China - Wuhan
Tel: 86-27-5980-5300
Fax: 86-27-5980-5118

China - Xian
Tel: 86-29-8833-7252
Fax: 86-29-8833-7256

China - Xiamen
Tel: 86-592-2388138
Fax: 86-592-2388130

China - Zhuhai
Tel: 86-756-3210040
Fax: 86-756-3210049

ASIA/PACIFIC

India - Bangalore
Tel: 91-80-3090-4444
Fax: 91-80-3090-4123

India - New Delhi
Tel: 91-11-4160-8631
Fax: 91-11-4160-8632

India - Pune
Tel: 91-20-2566-1512
Fax: 91-20-2566-1513

Japan - Osaka
Tel: 81-6-6152-7160
Fax: 81-6-6152-9310

Japan - Tokyo
Tel: 81-3-6880-3770
Fax: 81-3-6880-3771

Korea - Daegu
Tel: 82-53-744-4301
Fax: 82-53-744-4302

Korea - Seoul
Tel: 82-2-554-7200
Fax: 82-2-558-5932 or
82-2-558-5934

Malaysia - Kuala Lumpur
Tel: 60-3-6201-9857
Fax: 60-3-6201-9859

Malaysia - Penang
Tel: 60-4-227-8870
Fax: 60-4-227-4068

Philippines - Manila
Tel: 63-2-634-9065
Fax: 63-2-634-9069

Singapore
Tel: 65-6334-8870
Fax: 65-6334-8850

Taiwan - Hsin Chu
Tel: 886-3-5778-366
Fax: 886-3-5770-955

Taiwan - Kaohsiung
Tel: 886-7-213-7828
Fax: 886-7-330-9305

Taiwan - Taipei
Tel: 886-2-2508-8600
Fax: 886-2-2508-0102

Thailand - Bangkok
Tel: 66-2-694-1351
Fax: 66-2-694-1350

EUROPE

Austria - Wels
Tel: 43-7242-2244-39
Fax: 43-7242-2244-393

Denmark - Copenhagen
Tel: 45-4450-2828
Fax: 45-4485-2829

France - Paris
Tel: 33-1-69-53-63-20
Fax: 33-1-69-30-90-79

Germany - Munich
Tel: 49-89-627-144-0
Fax: 49-89-627-144-44

Italy - Milan
Tel: 39-0331-742611
Fax: 39-0331-466781

Netherlands - Drunen
Tel: 31-416-690399
Fax: 31-416-690340

Spain - Madrid
Tel: 34-91-708-08-90
Fax: 34-91-708-08-91

UK - Wokingham
Tel: 44-118-921-5869
Fax: 44-118-921-5820

11/29/12



Компания «ЭлектроПласт» предлагает заключение долгосрочных отношений при поставках импортных электронных компонентов на взаимовыгодных условиях!

Наши преимущества:

- Оперативные поставки широкого спектра электронных компонентов отечественного и импортного производства напрямую от производителей и с крупнейших мировых складов;
- Поставка более 17-ти миллионов наименований электронных компонентов;
- Поставка сложных, дефицитных, либо снятых с производства позиций;
- Оперативные сроки поставки под заказ (от 5 рабочих дней);
- Экспресс доставка в любую точку России;
- Техническая поддержка проекта, помощь в подборе аналогов, поставка прототипов;
- Система менеджмента качества сертифицирована по Международному стандарту ISO 9001;
- Лицензия ФСБ на осуществление работ с использованием сведений, составляющих государственную тайну;
- Поставка специализированных компонентов (Xilinx, Altera, Analog Devices, Intersil, Interpoint, Microsemi, Aeroflex, Peregrine, Syfer, Eurofarad, Texas Instrument, Miteq, Cobham, E2V, MA-COM, Hittite, Mini-Circuits, General Dynamics и др.);

Помимо этого, одним из направлений компании «ЭлектроПласт» является направление «Источники питания». Мы предлагаем Вам помощь Конструкторского отдела:

- Подбор оптимального решения, техническое обоснование при выборе компонента;
- Подбор аналогов;
- Консультации по применению компонента;
- Поставка образцов и прототипов;
- Техническая поддержка проекта;
- Защита от снятия компонента с производства.



Как с нами связаться

Телефон: 8 (812) 309 58 32 (многоканальный)

Факс: 8 (812) 320-02-42

Электронная почта: org@eplast1.ru

Адрес: 198099, г. Санкт-Петербург, ул. Калинина, дом 2, корпус 4, литера А.