

Silicon NPN Phototransistor

Version 1.3

SFH 309 FA



Features:

- **Spectral range of sensitivity:** (typ) 730 ... 1120 nm
- **Package:** 3mm Radial (T 1), Epoxy
- **Special:** High photosensitivity
- High linearity
- Available in groups

Applications

- Photointerrupters
- Industrial electronics
- For control and drive circuits

Ordering Information

Type:	Photocurrent I_{PCE} [μ A] $\lambda = 950$ nm, $E_e = 0.5$ mW/cm ² , $V_{CE} = 5$ V	Ordering Code
SFH 309 FA	400 ... 5000	Q62702P0941
SFH 309 FA-3/4	630 ... 2000	Q62702P3590
SFH 309 FA-4	1000 ... 2000	Q62702P0178
SFH 309 FA-4/5	1000 ... 3200	Q62702P3591
SFH 309 FA-5	1600 ... 3200	Q62702P0180
SFH 309 FA-5/6	1600 ... 5000	Q62702P5199

Note: Only one bin within one packing unit (variation less than 2:1)

Maximum Ratings ($T_A = 25\text{ °C}$)

Parameter	Symbol	Values	Unit
Operating and storage temperature range	$T_{op}; T_{stg}$	-40 ... 100	°C
Collector-emitter voltage	V_{CE}	35	V
Collector current	I_C	15	mA
Collector surge current ($\tau < 10\ \mu\text{s}$)	I_{CS}	75	mA
Total Power dissipation	P_{tot}	165	mW
Thermal resistance	R_{thJA}	450	K / W
ESD withstand voltage (acc. to ANSI/ ESDA/ JEDEC JS-001 - HBM)	V_{ESD}	2000	V

Characteristics ($T_A = 25\text{ °C}$)

Parameter		Symbol	Values	Unit
Wavelength of max. sensitivity	(typ)	$\lambda_{S\ max}$	900	nm
Spectral range of sensitivity	(typ)	$\lambda_{10\%}$	(typ) 730 ... 1120	nm
Radiant sensitive area ($\varnothing\ 220\ \mu\text{m}$)	(typ)	A	0.038	mm ²
Dimensions of chip area	(typ)	L x W	(typ) 0.45 x 0.45	mm x mm
Distance chip front to case surface	(min ... max)	H	(min ... max) 2.4 ... 2.8	mm
Half angle	(typ)	φ	± 12	°
Capacitance ($V_{CE} = 0\ \text{V}$, $f = 1\ \text{MHz}$, $E = 0$)	(typ)	C_{CE}	5	pF
Dark current ($V_{CE} = 20\ \text{V}$, $E = 0$)	(typ (max))	I_{CE0}	1 (≤ 50)	nA

Grouping ($T_A = 25\text{ }^\circ\text{C}$, $\lambda = 950\text{ nm}$)

Group	Min Photocurrent $E_e = 0.5\text{ mW/cm}^2$, $V_{CE} = 5\text{ V}$ $I_{PCE, min}\text{ }[\mu\text{A}]$	Max Photocurrent $E_e = 0.5\text{ mW/cm}^2$, $V_{CE} = 5\text{ V}$ $I_{PCE, max}\text{ }[\mu\text{A}]$	Rise and fall time $I_C = 1\text{ mA}$, $V_{CC} = 5\text{ V}$, $R_L = 1\text{ k}\Omega$ $t_r, t_f\text{ }[\mu\text{s}]$	Collector-emitter saturation voltage $I_C = I_{PCEmin} \times 0.3$, $E_e = 0.5\text{ mW/cm}^2$ $V_{CEsat}\text{ }[\text{mV}]$
-2	400	800	5	200
-3	630	1250	6	200
-4	1000	2000	7	200
-5	1600	3200	8	200
-6	2500	5000	9	200

Note.: I_{PCEmin} is the min. photocurrent of the specified group.

Relative Spectral Sensitivity ^{1) page 9}

$S_{rel} = f(\lambda)$

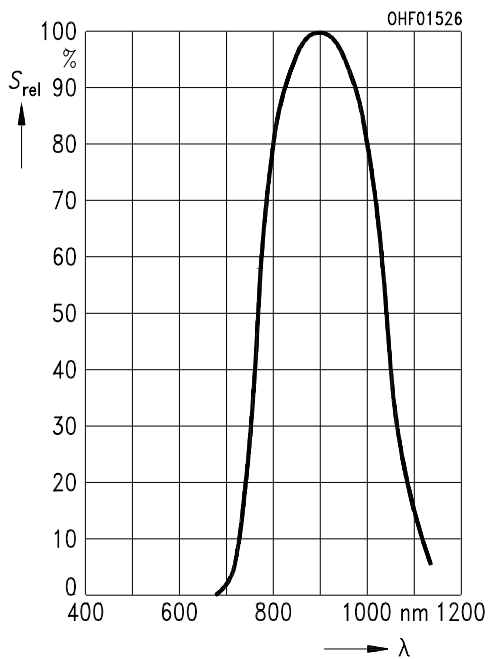

Photocurrent ^{1) page 9}

$I_{PCE} = f(E_e), V_{CE} = 5\text{ V}$

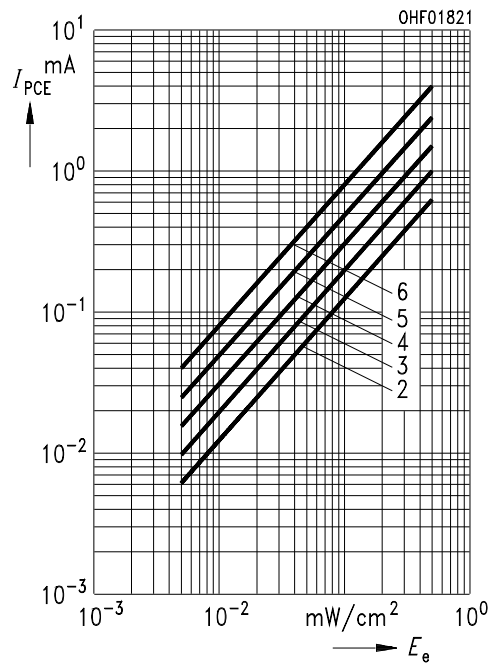

Photocurrent ^{1) page 9}

$I_{PCE} = f(V_{CE}), E_e = \text{Parameter}$

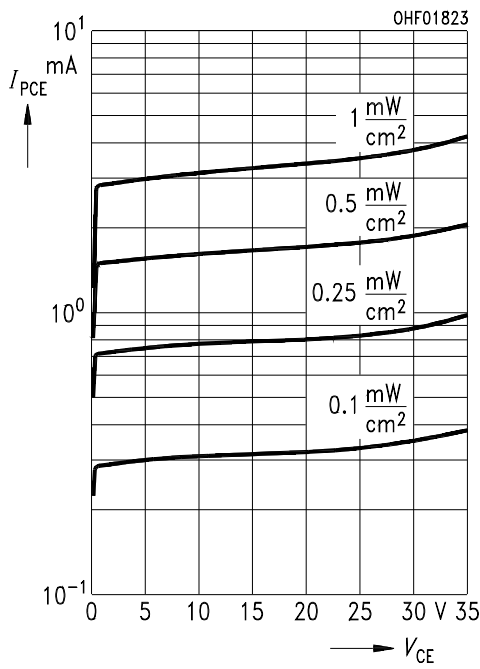

Photocurrent ^{1) page 9}

$I_{PCE} / I_{PCE}(25^\circ\text{C}) = f(T_A), V_{CE} = 5 \text{ V}$



Dark Current ^{1) page 9}

$I_{CEO} = f(V_{CE}), E = 0$

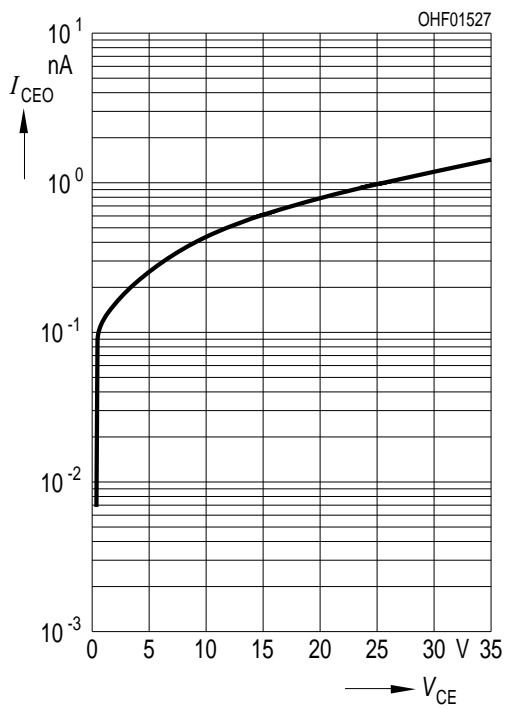

Dark Current ^{1) page 9}

$I_{CEO} = f(T_A), V_{CE} = 20 \text{ V}, E = 0$

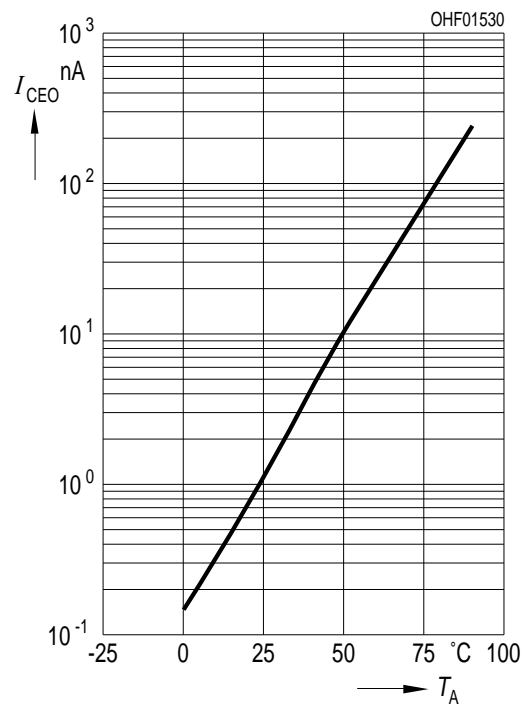

Collector-Emitter Capacitance ^{1) page 9}

$C_{CE} = f(V_{CE}), f = 1 \text{ MHz}, E = 0$

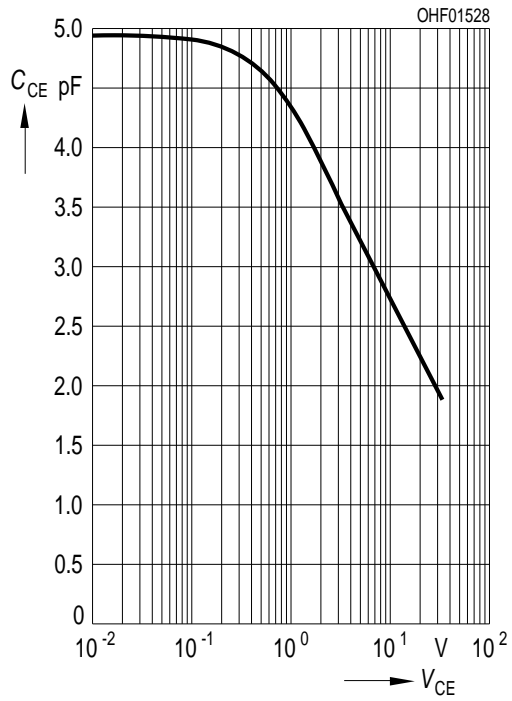

Power Consumption

$P_{tot} = f(T_A)$

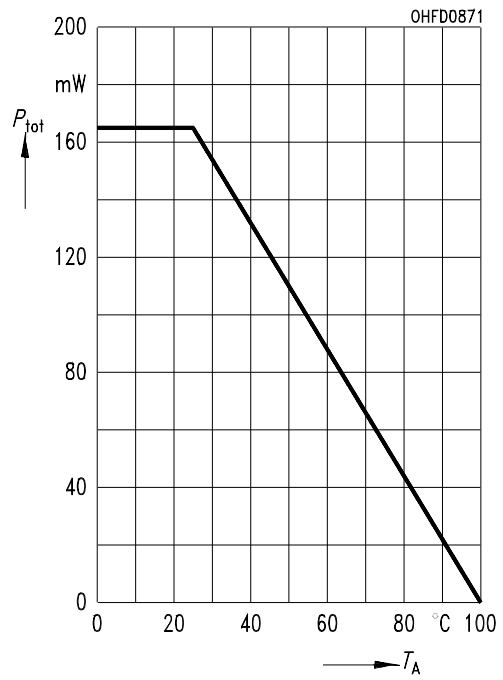

Directional Characteristics ^{1) page 9}

$S_{rel} = f(\phi)$

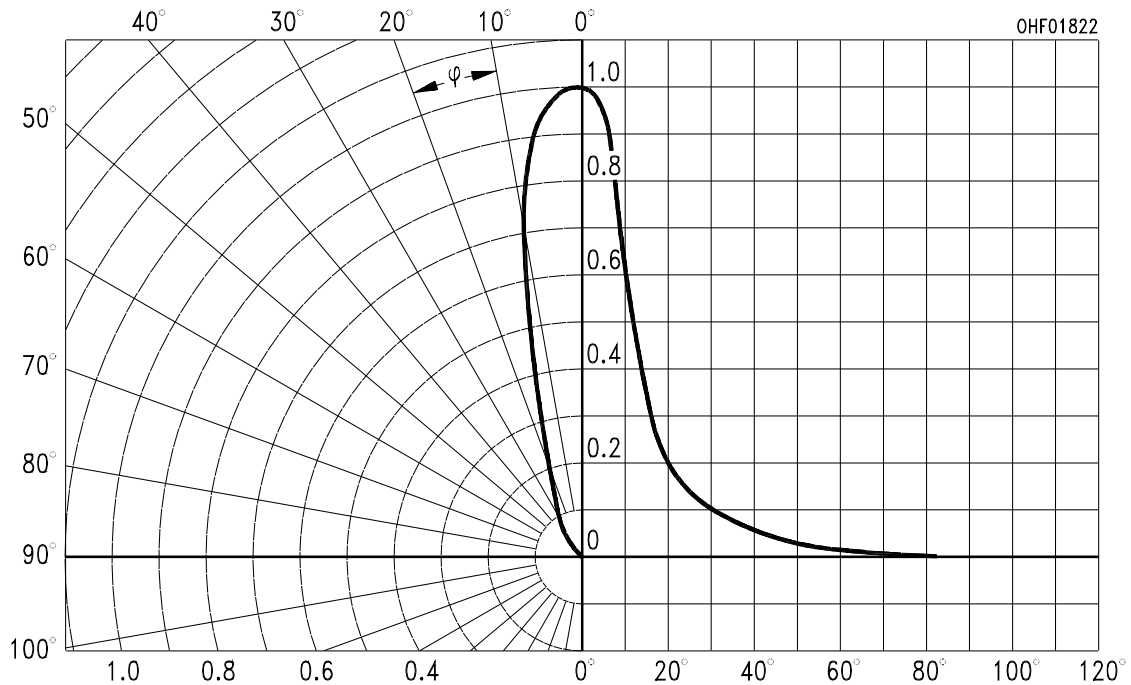

Package Outline

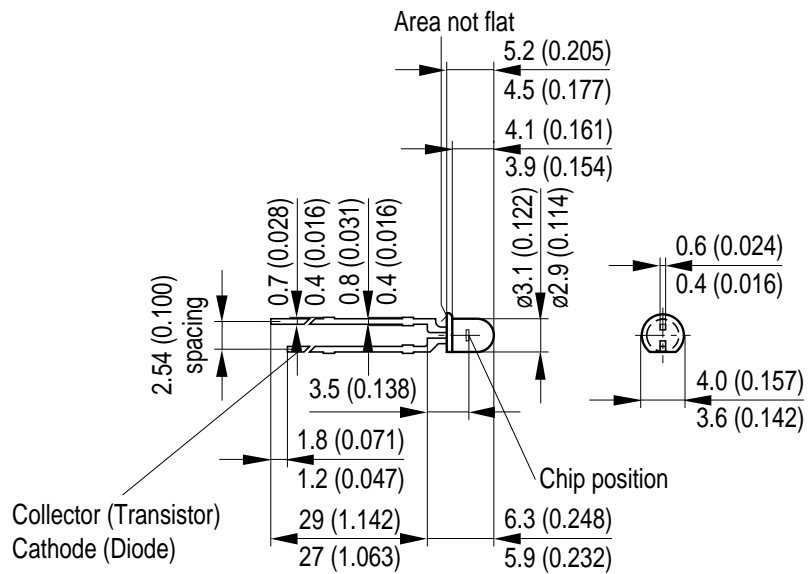

Dimensions in mm (inch).

Package

3mm Radial (T 1), Epoxy

Approximate Weight:

0.2 g

Note

Packing information is available on the internet (online product catalog).

Recommended Solder Pad



E062.3010.188-01

Dimensions in mm.

Note:

pad 1: emitter

TTW Soldering

IEC-61760-1 TTW

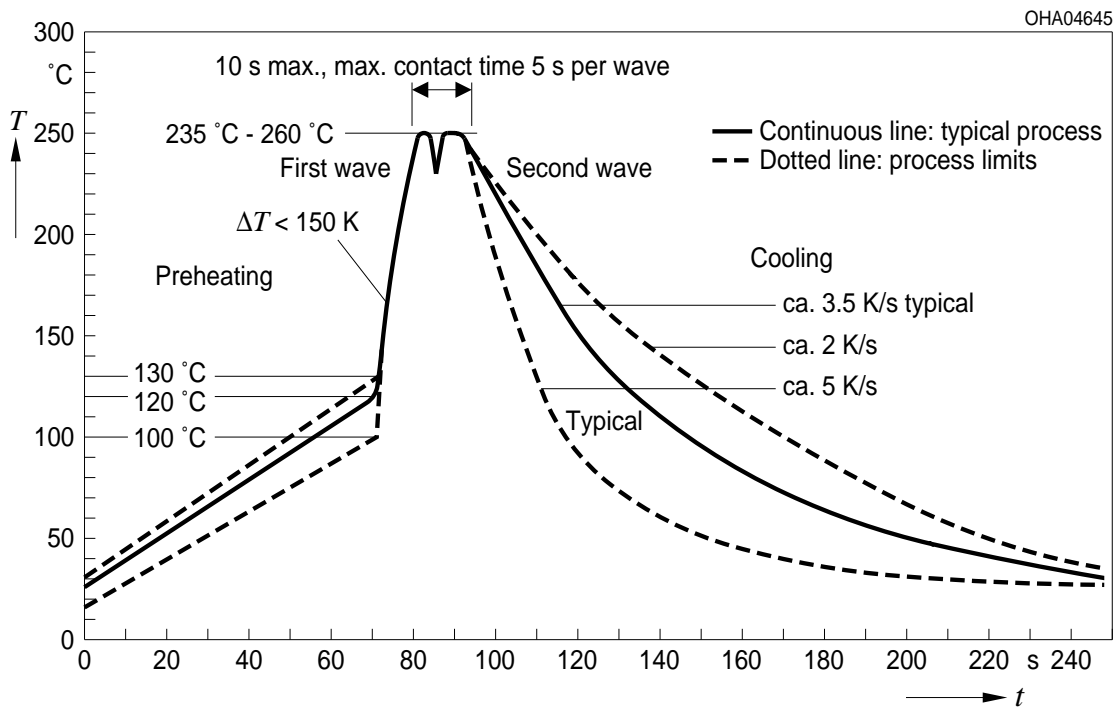

Disclaimer

Language english will prevail in case of any discrepancies or deviations between the two language wordings.

Attention please!

The information describes the type of component and shall not be considered as assured characteristics.

Terms of delivery and rights to change design reserved. Due to technical requirements components may contain dangerous substances.

For information on the types in question please contact our Sales Organization.

If printed or downloaded, please find the latest version in the Internet.

Packing

Please use the recycling operators known to you. We can also help you – get in touch with your nearest sales office.

By agreement we will take packing material back, if it is sorted. You must bear the costs of transport. For packing material that is returned to us unsorted or which we are not obliged to accept, we shall have to invoice you for any costs incurred.

Components used in life-support devices or systems must be expressly authorized for such purpose!

Critical components* may only be used in life-support devices** or systems with the express written approval of OSRAM OS.

*) A critical component is a component used in a life-support device or system whose failure can reasonably be expected to cause the failure of that life-support device or system, or to affect its safety or the effectiveness of that device or system.

**) Life support devices or systems are intended (a) to be implanted in the human body, or (b) to support and/or maintain and sustain human life. If they fail, it is reasonable to assume that the health and the life of the user may be endangered.

Glossary

- ¹⁾ **Typical Values:** Due to the special conditions of the manufacturing processes of LED, the typical data or calculated correlations of technical parameters can only reflect statistical figures. These do not necessarily correspond to the actual parameters of each single product, which could differ from the typical data and calculated correlations or the typical characteristic line. If requested, e.g. because of technical improvements, these typ. data will be changed without any further notice.

Published by OSRAM Opto Semiconductors GmbH
Leibnizstraße 4, D-93055 Regensburg
www.osram-os.com © All Rights Reserved.

EU RoHS and China RoHS compliant product



此产品符合欧盟 RoHS 指令的要求；
按照中国的相关法规和标准，不含有毒有害物质或元素。



Компания «ЭлектроПласт» предлагает заключение долгосрочных отношений при поставках импортных электронных компонентов на взаимовыгодных условиях!

Наши преимущества:

- Оперативные поставки широкого спектра электронных компонентов отечественного и импортного производства напрямую от производителей и с крупнейших мировых складов;
- Поставка более 17-ти миллионов наименований электронных компонентов;
- Поставка сложных, дефицитных, либо снятых с производства позиций;
- Оперативные сроки поставки под заказ (от 5 рабочих дней);
- Экспресс доставка в любую точку России;
- Техническая поддержка проекта, помощь в подборе аналогов, поставка прототипов;
- Система менеджмента качества сертифицирована по Международному стандарту ISO 9001;
- Лицензия ФСБ на осуществление работ с использованием сведений, составляющих государственную тайну;
- Поставка специализированных компонентов (Xilinx, Altera, Analog Devices, Intersil, Interpoint, Microsemi, Aeroflex, Peregrine, Syfer, Eurofarad, Texas Instrument, Miteq, Cobham, E2V, MA-COM, Hittite, Mini-Circuits, General Dynamics и др.);

Помимо этого, одним из направлений компании «ЭлектроПласт» является направление «Источники питания». Мы предлагаем Вам помощь Конструкторского отдела:

- Подбор оптимального решения, техническое обоснование при выборе компонента;
- Подбор аналогов;
- Консультации по применению компонента;
- Поставка образцов и прототипов;
- Техническая поддержка проекта;
- Защита от снятия компонента с производства.



Как с нами связаться

Телефон: 8 (812) 309 58 32 (многоканальный)

Факс: 8 (812) 320-02-42

Электронная почта: org@eplast1.ru

Адрес: 198099, г. Санкт-Петербург, ул. Калинина, дом 2, корпус 4, литера А.