

SERIES 1830 - HIGH INRUSH SINGLE POLE AND DOUBLE POLE

ROCKER SWITCHES UP TO 20 (4) A 250 V~

SINGLE POLE ST-SWITCHES

illuminated

20 (4) A 250 V~
 10 (8) A 250 V~ 5E4
 5/120 A 250 V~
 T 85/55
 16 A (1 HP) 250 V AC

Switches for 125 V AC on request



6.3 1830.3111



6.3 1830.3112*



6.3 1830.3118*



6.3 1830.8112*

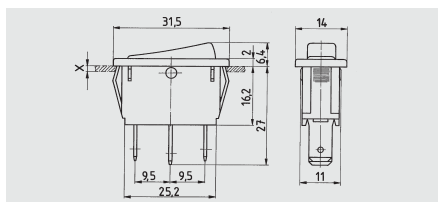

quick-connect terminal 6.3

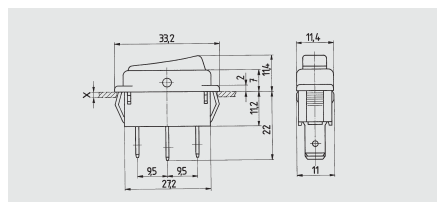

quick-connect terminal 6.3

DOUBLE POLE ST-SWITCHES

illuminated

20 (4) A 250 V~
 10 (8) A 250 V~ 5E4
 5/120 A 250 V~
 T 85/55
 16 A (1 HP) 250 V AC

Switches for 125 V AC or 400 V AC on request



6.3 1835.3114



6.3 1835.3112*



6.3 1835.3111



6.3 1835.3118*

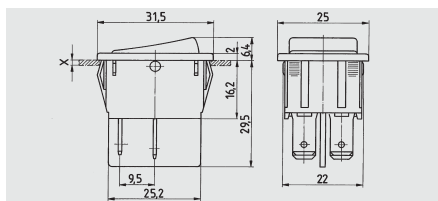

quick-connect terminal 6.3

SINGLE POLE ST-SWITCHES

20 (4) A 250 V~
 10 (8) A 250 V~ 5E4
 5/120 A 250 V~
 T 105/55
 16 A (1/3 HP) 125 V AC
 16 A (1 HP) 250 V AC



6.3 1831.3312*



6.3 1831.3313*
 1831.0115



6.3 1831.3933*
 1831.0114*



6.3 1831.8112*

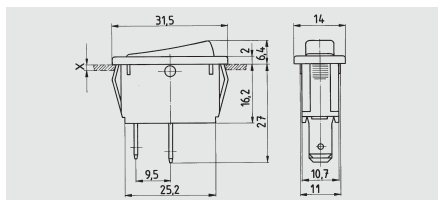

quick-connect terminal 6.3

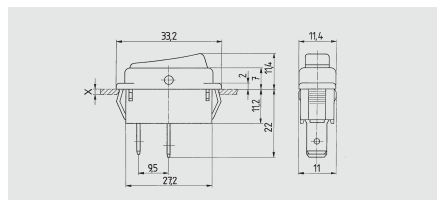

quick-connect terminal 6.3

DOUBLE POLE ST-SWITCHES

20(4) A 250 V~
 10(8) A 250 V~ 5E4
 5/120 A 250 V~
 T 105/55
 16 A (1/3 HP) 125 V AC
 16 A (1 HP) 250 V AC



6.3 1832.3312* 6.3 1832.3311* 6.3 1832.8112*

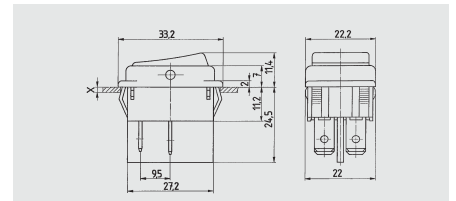
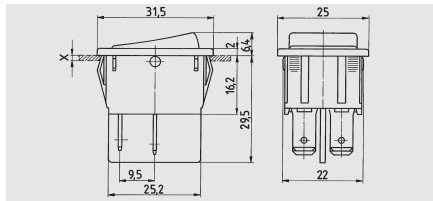

quick-connect terminal 6.3

quick-connect terminal 6.3

SINGLE POLE DT-SWITCHES

10(4) A 250 V~
 6(4) A 250 V~ 5E4
 T 105/55
 6 A (1/4 HP) 125 V AC
 6 A (1/2 HP) 250 V AC



6.3 1833.3302* 6.3 1833.3305* 6.3 1833.8102

16(4) A 250 V~
 T 105/55
 16 A (1/3 HP) 125 V AC
 16 A (1/2 HP) 250 V AC

6.3 1833.3312

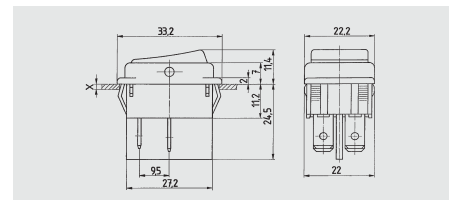
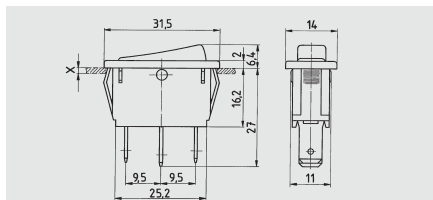

quick-connect terminal 6.3

quick-connect terminal 6.3

DOUBLE POLE DT-SWITCHES

10(4) A 250 V~
 6(4) A 250 V~ 5E4
 T 105/55
 6 A (1/4 HP) 125 V AC
 6 A (1/2 HP) 250 V AC

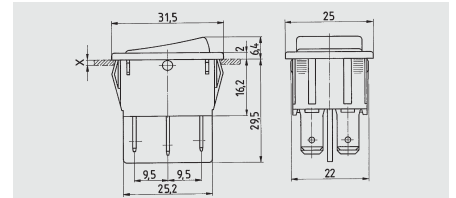

6.3 1834.3302* 6.3 1834.3309* quick-connect terminal 6.3

16(4) A 250 V~
 T 105/55
 16 A (1/3 HP) 125 V AC
 16 A (1/2 HP) 250 V AC

6.3 1834.3312

SERIES 1830 - HIGH INRUSH SINGLE POLE AND DOUBLE POLE

ROCKER SWITCHES UP TO 20 (4) A 250 V~

SINGLE POLE DT-SWITCHES

with centre-OFF

6 (4) A 250 V~

T 105/55

6 A (1/8 HP) 125-250 V AC



without momentary

6.3 1838.3502*

4.8 1838.1502*



momentary on both sides

6.3 1838.3402*

4.8 1838.1402*



without momentary

4.8 1838.1509*

16 (4) A 250 V~

T 105/55

16 A (1/3 HP) 125 V AC

16 A (1/2 HP) 250 V AC

6.3 1838.3512

6.3 1838.3412

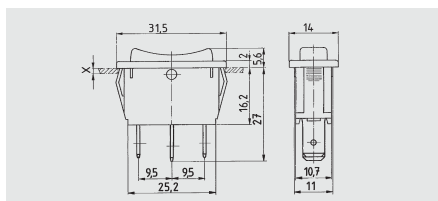

quick-connect terminal 6.3

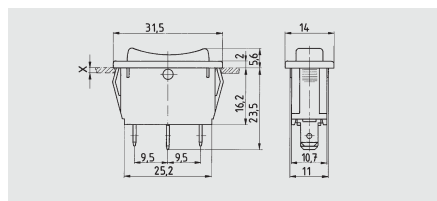

quick-connect terminal 4.8

Momentary function on one side on request

DOUBLE POLE DT-SWITCHES

with centre-OFF

6 (4) A 250 V~

T 105/55

6 A (1/8 HP) 125-250 V AC



without momentary

6.3 1839.3502*

4.8 1839.1502



momentary on both sides

6.3 1839.3402*

4.8 1839.1402*



momentary on both sides

4.8 1839.1407*

16 (4) A 250 V~

T 105/55

16 A (1/3 HP) 125 V AC

16 A (1/2 HP) 250 V AC

6.3 1839.3512

6.3 1839.3412

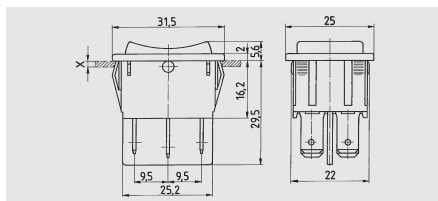

quick-connect terminal 6.3

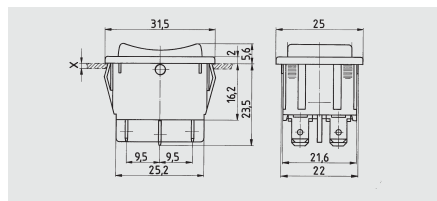

quick-connect terminal 4.8

Momentary function on one side on request

SWITCHES WITH MOMENTARY FUNCTION

4 (2) A 250 V~

T 105/55

6 A (1/10 HP) 125 V AC

4 A (1/10 HP) 250 V AC



normally open

6.3 1831.3402



DT momentary

6.3 1833.3402

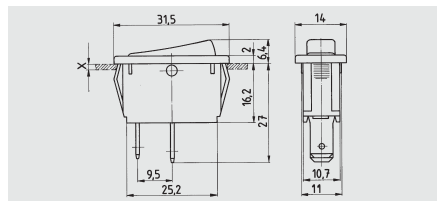

quick-connect terminal 6.3

DOUBLE POLE WITH MOMENTARY FUNCTION

4 (2) A 250 V~
 T 105/55
 6 A (1/10 HP) 125 V AC
 4 A (1/10 HP) 250 V AC



normally open
 6.3 1832.3407



DT momentary
 6.3 1834.3402*

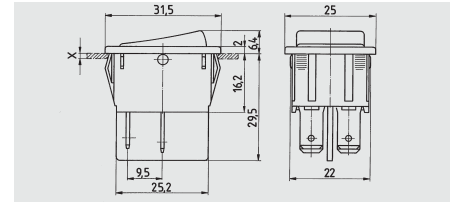

quick-connect terminal 6.3

PILOT LIGHTS

Pilot lights with neon lamp and resistor for 230 V~



Pilot light for 125 V AC according to UL and other colours on request.



6.3 1837.3102*

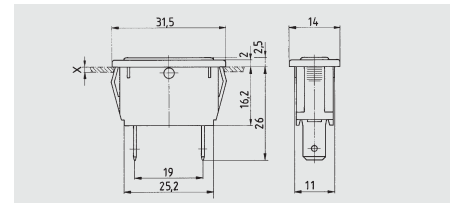

quick-connect terminal 6.3 resp. 4.8



6.3 1837.8102*



6.3 1837.8108

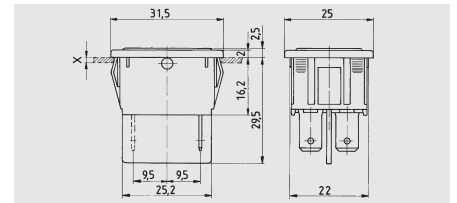

quick-connect terminal 6.3

SERIES 1830 - ROCKER SWITCHES WITH INTEGRATED DUST PROTECTION

Several double pole versions with integrated dust protection are available in the 1830 series.

The diagram opposite shows how the seal in the switch offers a better protection for the contact system against dust penetration.

On request we will supply the switch versions with this dust protection.

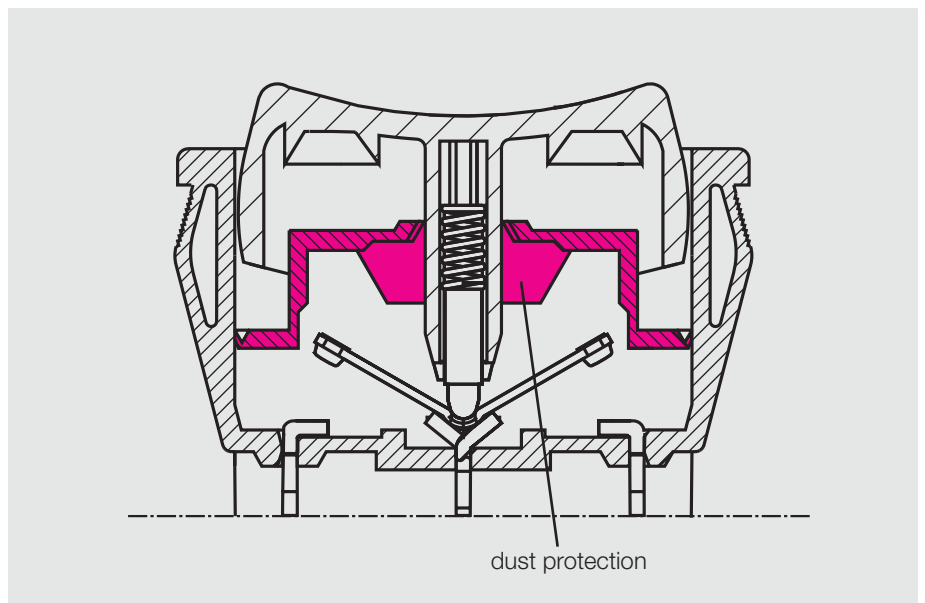

* Version on stock



Компания «ЭлектроПласт» предлагает заключение долгосрочных отношений при поставках импортных электронных компонентов на взаимовыгодных условиях!

Наши преимущества:

- Оперативные поставки широкого спектра электронных компонентов отечественного и импортного производства напрямую от производителей и с крупнейших мировых складов;
- Поставка более 17-ти миллионов наименований электронных компонентов;
- Поставка сложных, дефицитных, либо снятых с производства позиций;
- Оперативные сроки поставки под заказ (от 5 рабочих дней);
- Экспресс доставка в любую точку России;
- Техническая поддержка проекта, помощь в подборе аналогов, поставка прототипов;
- Система менеджмента качества сертифицирована по Международному стандарту ISO 9001;
- Лицензия ФСБ на осуществление работ с использованием сведений, составляющих государственную тайну;
- Поставка специализированных компонентов (Xilinx, Altera, Analog Devices, Intersil, Interpoint, Microsemi, Aeroflex, Peregrine, Syfer, Eurofarad, Texas Instrument, Miteq, Cobham, E2V, MA-COM, Hittite, Mini-Circuits, General Dynamics и др.);

Помимо этого, одним из направлений компании «ЭлектроПласт» является направление «Источники питания». Мы предлагаем Вам помощь Конструкторского отдела:

- Подбор оптимального решения, техническое обоснование при выборе компонента;
- Подбор аналогов;
- Консультации по применению компонента;
- Поставка образцов и прототипов;
- Техническая поддержка проекта;
- Защита от снятия компонента с производства.



Как с нами связаться

Телефон: 8 (812) 309 58 32 (многоканальный)

Факс: 8 (812) 320-02-42

Электронная почта: org@eplast1.ru

Адрес: 198099, г. Санкт-Петербург, ул. Калинина, дом 2, корпус 4, литера А.