

CATV 75 Ω Push Pull Amplifier 45 - 1200 MHz

Rev. V2

Features

- 25 dB Gain
- 12 Volts DC Bias
- Differential Inputs and Outputs
- Low Distortion
- Adjustable Bias Current and Gain Control
- Lead-Free 5 x 7 mm 40-Lead PQFN Package
- Halogen-Free “Green” Mold Compound
- RoHS* Compliant

Description

The MAAM-011169 is a GaAs MMIC amplifier configured as two stages of differential amplifiers for broadband performance. It is optimized for very low distortion and noise figure in a 75 Ω push-pull amplifier circuit. It provides excellent input and output return loss over the 45 to 1200 MHz operating frequencies.

The device is ideally suited for CATV applications including line amplifiers, HFC, and FTTL nodes.

Functional Schematic

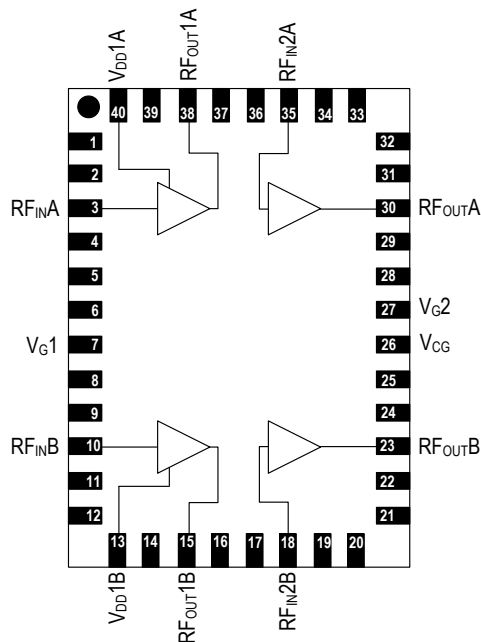

Pin Configuration³

Pin No.	Pin Name	Description
All pins not marked	N/C	No Connection
3	RF _{IN} A	Amp1 RF in+
7	V _G 1	Amp1 DC Adjust
10	RF _{IN} B	Amp1 RF in-
13	V _{DD} 1B	Amp1 DC-
15	RF _{OUT} 1B	Amp1 RF out-
18	RF _{IN} 2B	Amp2 RF in-
23	RF _{OUT} B	Amp2 RF out-
26	V _{CG}	Amp2 DC Bias
27	V _G 2	Amp2 DC Adjust
30	RF _{OUT} A	Amp2 RF out+
35	RF _{IN} 2A	Amp2 RF in+
38	RF _{OUT} 1A	Amp1 RF out+
40	V _{DD} 1A	Amp1 DC+
41	Paddle ⁴	Ground

Ordering Information^{1,2}

Part Number	Package
MAAM-011169	Bulk Packaging
MAAM-011169-TR1000	1000 Piece Reel
MAAM-011169-TR3000	3000 Piece Reel
MAAM-011169-001SMB	Sample Test Board

1. Reference Application Note M513 for reel size information.
2. All sample boards include 5 loose parts.

* Restrictions on Hazardous Substances, European Union Directive 2011/65/EU.

3. MACOM recommends connecting all No Connection (N/C) pins to ground.
4. The exposed pad centered on the package bottom must be connected to RF and DC ground.

CATV 75 Ω Push Pull Amplifier 45 - 1200 MHz

Rev. V2

Electrical Specifications: $T_A = 35^\circ\text{C}$, $V_{DD} = +12\text{ Volts}$, $Z_0 = 75\ \Omega$

Parameter	Test Conditions	Units	Min.	Typ.	Max.
Gain	50 MHz 1200 MHz	dB	24 24	25 25	—
Gain Flatness	—	dB	—	+/-0.5	—
Noise Figure	45 MHz 1200 MHz	dB	—	5.9 4.4	—
Reverse Isolation	—	dB	—	37	—
Input Return Loss	45 MHz 1000 MHz 1200 MHz	dB	— 18 —	18.5 20.0 15.0	—
Output Return Loss	45 MHz 1000 MHz 1200 MHz	dB	18 18 18	19.5 22.0 20.0	—
CTB ⁵	60 + 39 PAL $V_O = 48\text{ dBmV Flat}$ 79 NTSC + 75 ATSC $V_O = 46\text{ dBmV Flat}$	dBc	—	-67 -67	— -63
CSO ⁵	60 + 39 PAL $V_O = 48\text{ dBmV Flat}$ 79 NTSC + 75 ATSC $V_O = 46\text{ dBmV Flat}$	dBc	—	-70 -70	— -64
XMOD ⁵	79 NTSC + 75 ATSC $V_O = 46\text{ dBmV Flat}$	dBc	—	-65	—
CIN ⁵	79 NTSC + 75 ATSC $V_O = 46\text{ dBmV Flat}$	dBc	—	-66	—
OIP3	1000 MHz, 6 MHz Spacing, 10 dBm P_{OUT} per tone	dBm	—	54	—
OIP2	1000 MHz, 6 MHz Spacing, 10 dBm P_{OUT} per tone	dBm	—	70	—
P1dB	1000 MHz	dBm	—	29	—
I_{DD} ⁶	12 Volts	mA	—	490	550

5. Digital channels are -6 dB relative to analog channels.

6. I_{DD} set with external resistors as shown in application schematics.

Maximum Operating Conditions⁷

Parameter	Absolute Maximum
RF Input Power	4 dBm
Voltage	12 Volts
Operating Temperature	-40°C to +100°C
Junction Temperature ⁸	+150°C

7. Operating at nominal conditions with $T_J \leq +150^\circ\text{C}$ will ensure $\text{MTTF} > 1 \times 10^6$ hours.

8. Junction Temperature (T_J) = $T_C + \Theta_{JC} * (V * I)$

Typical thermal resistance (Θ_{JC}) = 6.3 °C/W.

a) For $T_C = +35^\circ\text{C}$,

$T_J = 72^\circ\text{C}$ @ 12 V, 495 mA

b) For $T_C = +100^\circ\text{C}$,

$T_J = 137^\circ\text{C}$ @ 12 V, 495 mA

Absolute Maximum Ratings^{9,10}

Parameter	Absolute Maximum
RF Input Power	9 dBm
Voltage	15 Volts
Storage Temperature	-65°C to +150°C

9. Exceeding any one or combination of these limits may cause permanent damage to this device.

10. MACOM does not recommend sustained operation near these survivability limits.

Printed Circuit Board Thermal Design

To maintain reliable junction temperatures for this high power amplifier the printed circuit board (PCB) must provide low thermal resistance to the exposed paddle of the IC package. In general, thinner substrates and thicker plating for vias provide lower thermal resistance. Calculation of case temperature must include temperature rise in PCB.

Thermal Via Array, 62-mil PCB

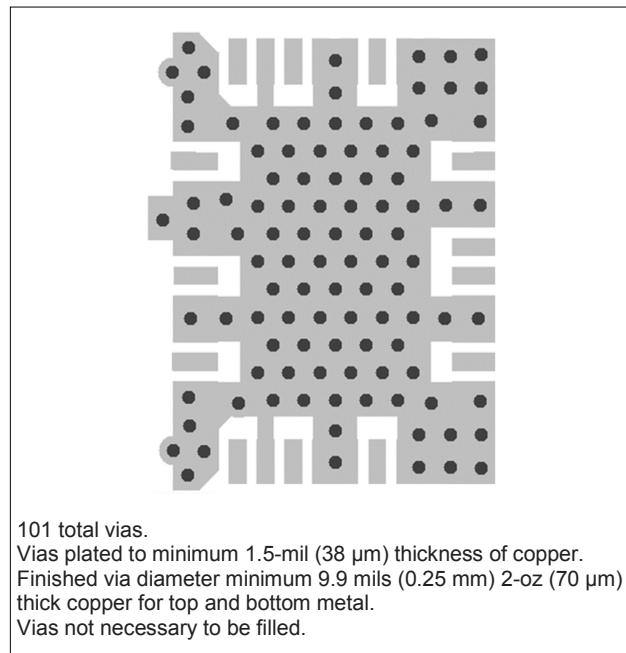

Handling Procedures

Please observe the following precautions to avoid damage:

Static Sensitivity

These electronic devices are sensitive to electrostatic discharge (ESD) and can be damaged by static electricity. Proper ESD control techniques should be used when handling these devices.

CATV 75 Ω Push Pull Amplifier 45 - 1200 MHz

Rev. V2

Application Schematic

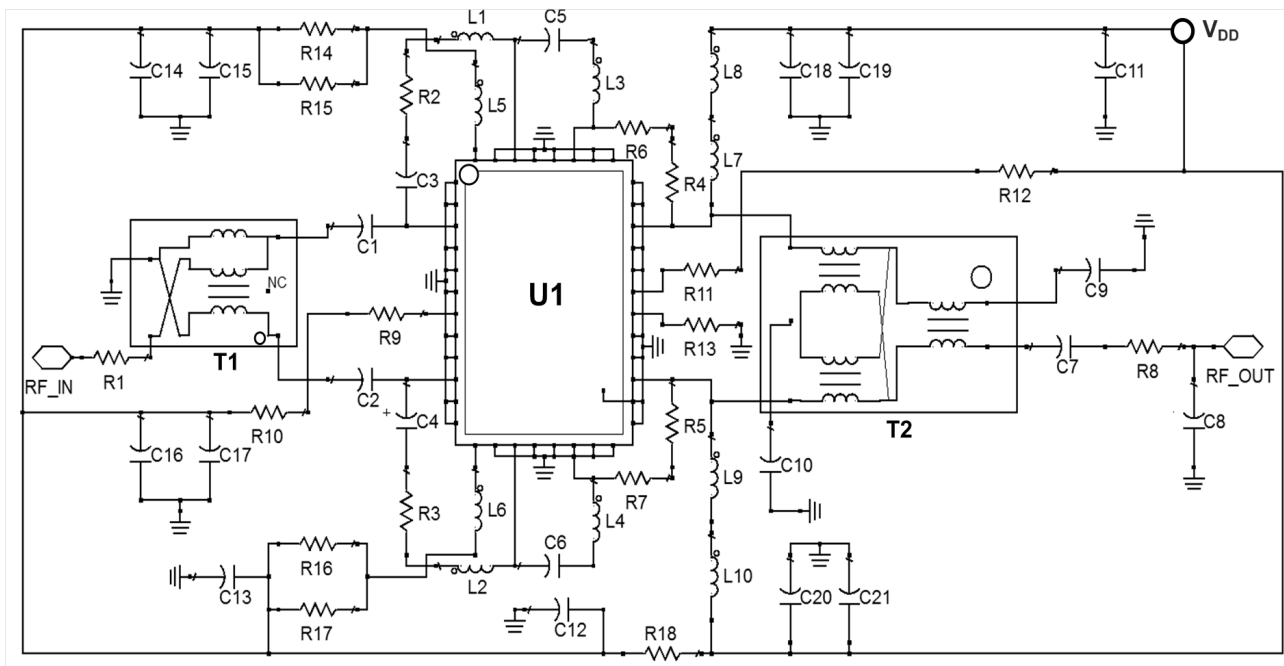

Recommended PCB Layout

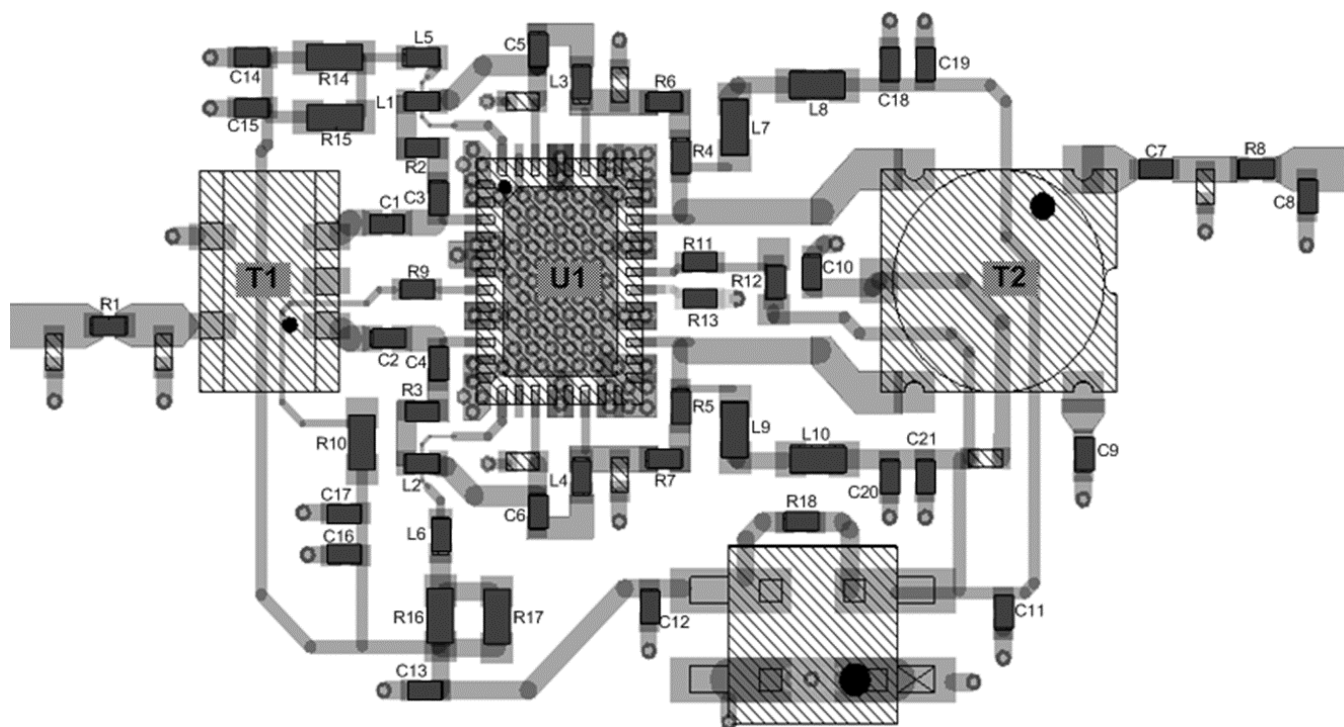

Recommended Off-Chip Component Values

Component	Value	Package	QTY	Vendor	Part Number
C1, C2, C3, C4, C7, C9, C10, C11, C12, C14, C16, C19, C21	10 nF	0402	13	MURATA	GRM155R71H103KA88D
C13, C15, C17, C18, C20	1000 pF	0402	5	MURATA	GRM155R71H102KA01D
C5, C6	270 pF	0402	2	MURATA	GRM1555C1H271JA01D
C8	0.6 pF	0402	1	MURATA	GRM1555C1HR60BA01D
L5, L6	1800 Ω	0402	2	MURATA	BLM15HD182SN1D
L7, L8, L9, L10	1500 Ω	0603	4	MURATA	BLM18HE152SN1D
L3, L4	2.7 nH	0402	2	MURATA	LQG15HS2N7S02D
L1, L2	2.2 nH	0402	2	MURATA	LQG15HS2N2S02D
R13	562 Ω	0402	1	PANASONIC	ERJ-2RKF5620X
R4, R5	499 Ω	0402	2	PANASONIC	ERJ-2RKF4990X
R9, R11	300 Ω	0402	2	ROHM	ESR01MZPJ301
R2, R3	215 Ω	0402	2	PANASONIC	ERJ-2RKF2150X
R10	200 Ω	0603	1	ROHM	ESR03EZPF2000
R12	158 Ω	0402	1	PANASONIC	ERJ-2RKF1580X
R14, R15, R16, R17	20 Ω	0603	4	ROHM	ESR03EZPJ200
R1, R6, R7, R8, R18	0 Ω	0402	5	PANASONIC	ERJ-2GE0R00X
Balun T1	1:1	—	1	MACOM	MABA-010321-CT1A42
Balun T2	1:2	—	1	MACOM	MABA-011029

Typical Performance Curves

Gain

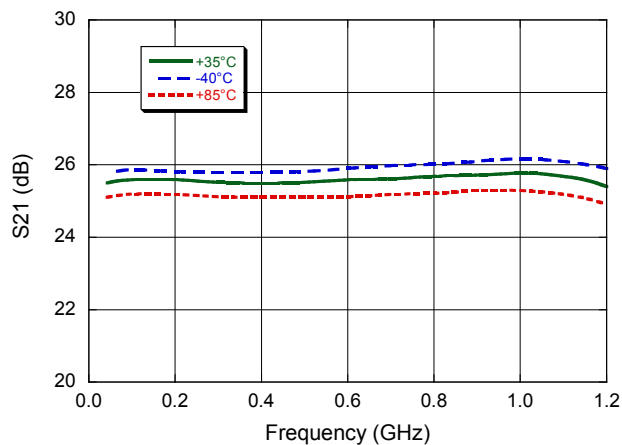

Reverse Isolation

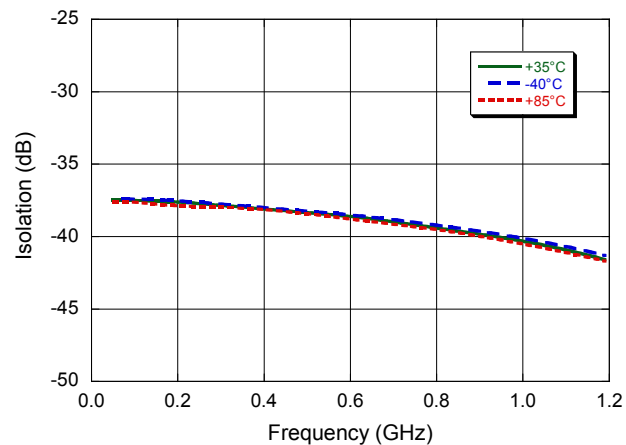

Input Return Loss

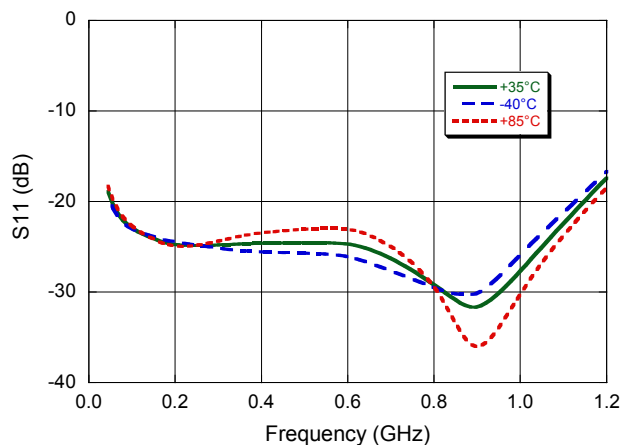

Output Return Loss

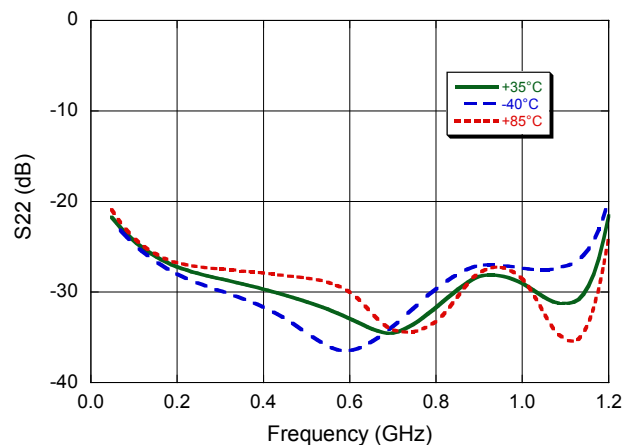

Noise Figure

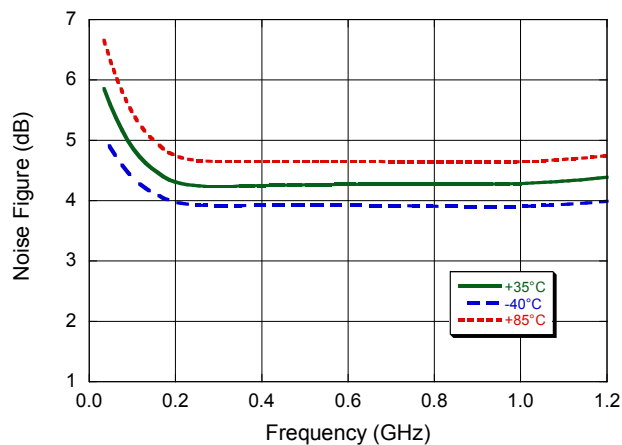

Typical Distortion Performance Curves @ +35°C:

99 PAL $V_O = 48$ dBmV/CH Flat in 60 Analog Channels, $V_O = 42$ dBmV Flat in 39 Digital Channels

Composite Triple Beat

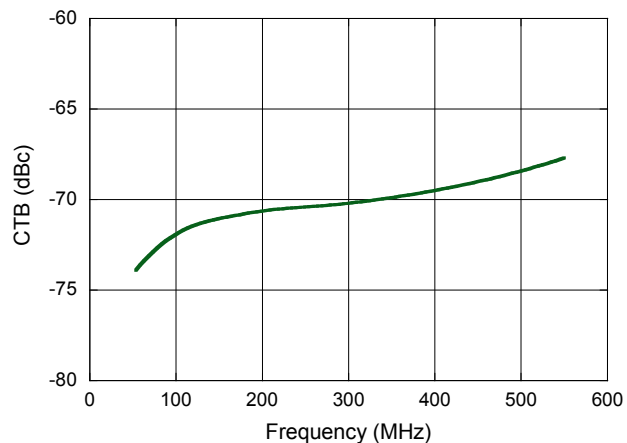

Composite Second Order

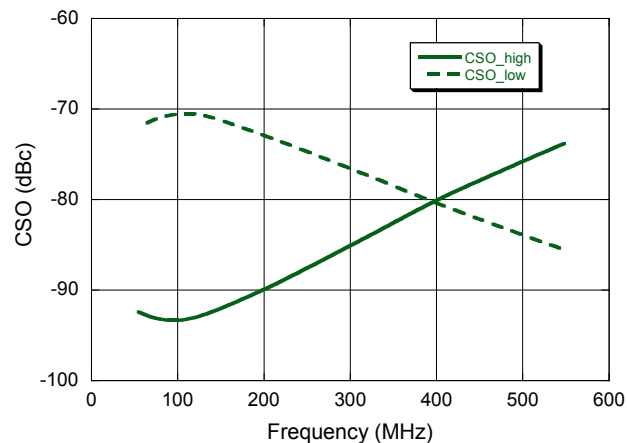

Typical Distortion Performance Curves @ +35°C:

$V_O = 46$ dBmV/CH Flat in 79 NTSC Analog Channels, $V_O = 40$ dBmV Flat in 75 ATSC Digital Channels

Composite Triple Beat

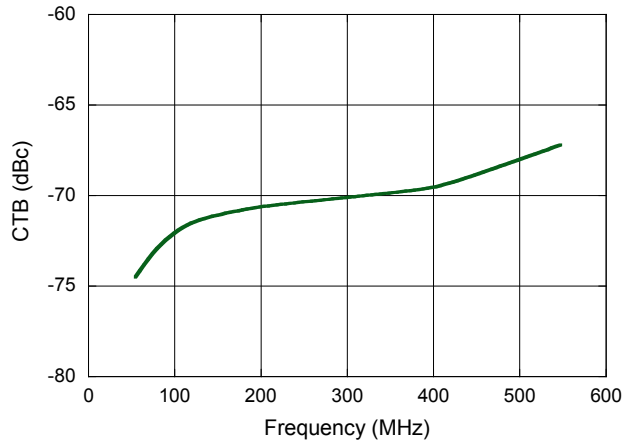

Composite Second Order

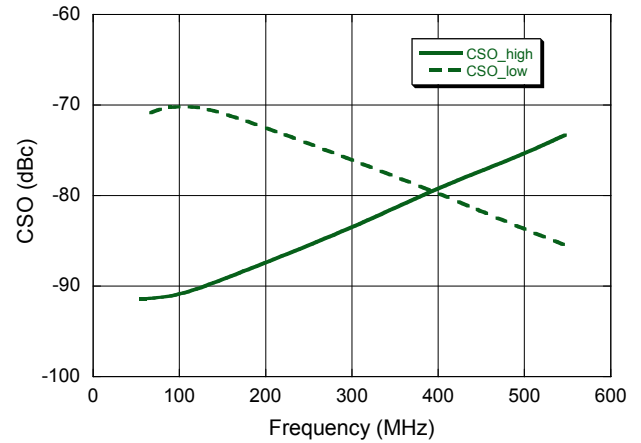

Cross Modulation

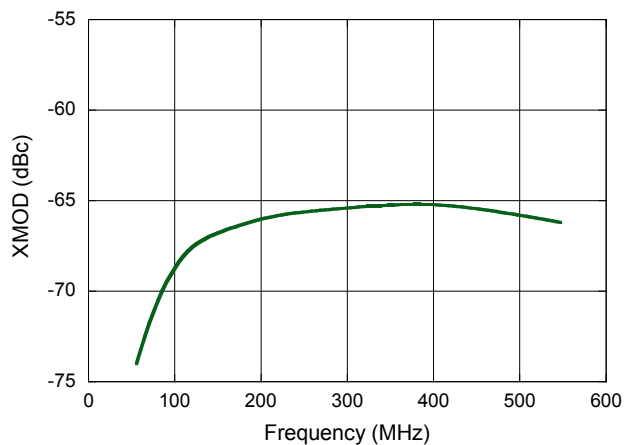

Carrier to Intermodulation Noise

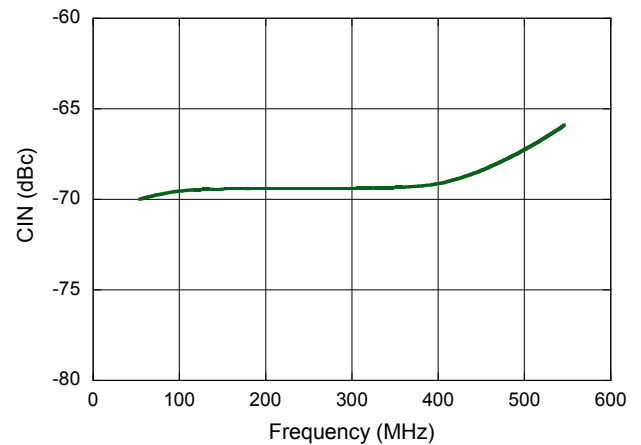

Lead-Free 5 x 7 mm 40-Lead PQFN†

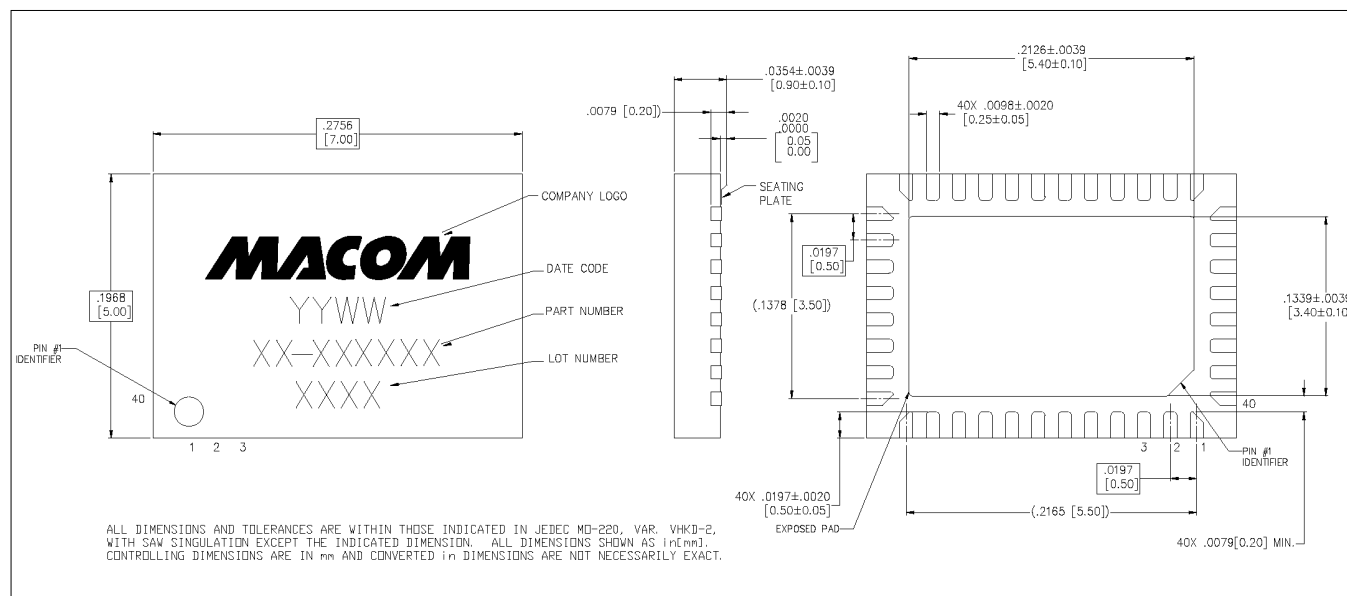

† Reference Application Note M538 for lead-free solder reflow recommendations.
Meets JEDEC Moisture Sensitivity Level 1 requirements.
Plating is NiPdAu.

M/A-COM Technology Solutions Inc. All rights reserved.

Information in this document is provided in connection with M/A-COM Technology Solutions Inc ("MACOM") products. These materials are provided by MACOM as a service to its customers and may be used for informational purposes only. Except as provided in MACOM's Terms and Conditions of Sale for such products or in any separate agreement related to this document, MACOM assumes no liability whatsoever. MACOM assumes no responsibility for errors or omissions in these materials. MACOM may make changes to specifications and product descriptions at any time, without notice. MACOM makes no commitment to update the information and shall have no responsibility whatsoever for conflicts or incompatibilities arising from future changes to its specifications and product descriptions. No license, express or implied, by estoppel or otherwise, to any intellectual property rights is granted by this document.

THESE MATERIALS ARE PROVIDED "AS IS" WITHOUT WARRANTY OF ANY KIND, EITHER EXPRESS OR IMPLIED, RELATING TO SALE AND/OR USE OF MACOM PRODUCTS INCLUDING LIABILITY OR WARRANTIES RELATING TO FITNESS FOR A PARTICULAR PURPOSE, CONSEQUENTIAL OR INCIDENTAL DAMAGES, MERCHANTABILITY, OR INFRINGEMENT OF ANY PATENT, COPYRIGHT OR OTHER INTELLECTUAL PROPERTY RIGHT. MACOM FURTHER DOES NOT WARRANT THE ACCURACY OR COMPLETENESS OF THE INFORMATION, TEXT, GRAPHICS OR OTHER ITEMS CONTAINED WITHIN THESE MATERIALS. MACOM SHALL NOT BE LIABLE FOR ANY SPECIAL, INDIRECT, INCIDENTAL, OR CONSEQUENTIAL DAMAGES, INCLUDING WITHOUT LIMITATION, LOST REVENUES OR LOST PROFITS, WHICH MAY RESULT FROM THE USE OF THESE MATERIALS.

MACOM products are not intended for use in medical, lifesaving or life sustaining applications. MACOM customers using or selling MACOM products for use in such applications do so at their own risk and agree to fully indemnify MACOM for any damages resulting from such improper use or sale.



Компания «ЭлектроПласт» предлагает заключение долгосрочных отношений при поставках импортных электронных компонентов на взаимовыгодных условиях!

Наши преимущества:

- Оперативные поставки широкого спектра электронных компонентов отечественного и импортного производства напрямую от производителей и с крупнейших мировых складов;
- Поставка более 17-ти миллионов наименований электронных компонентов;
- Поставка сложных, дефицитных, либо снятых с производства позиций;
- Оперативные сроки поставки под заказ (от 5 рабочих дней);
- Экспресс доставка в любую точку России;
- Техническая поддержка проекта, помощь в подборе аналогов, поставка прототипов;
- Система менеджмента качества сертифицирована по Международному стандарту ISO 9001;
- Лицензия ФСБ на осуществление работ с использованием сведений, составляющих государственную тайну;
- Поставка специализированных компонентов (Xilinx, Altera, Analog Devices, Intersil, Interpoint, Microsemi, Aeroflex, Peregrine, Syfer, Eurofarad, Texas Instrument, Miteq, Cobham, E2V, MA-COM, Hittite, Mini-Circuits, General Dynamics и др.);

Помимо этого, одним из направлений компании «ЭлектроПласт» является направление «Источники питания». Мы предлагаем Вам помощь Конструкторского отдела:

- Подбор оптимального решения, техническое обоснование при выборе компонента;
- Подбор аналогов;
- Консультации по применению компонента;
- Поставка образцов и прототипов;
- Техническая поддержка проекта;
- Защита от снятия компонента с производства.



Как с нами связаться

Телефон: 8 (812) 309 58 32 (многоканальный)

Факс: 8 (812) 320-02-42

Электронная почта: org@eplast1.ru

Адрес: 198099, г. Санкт-Петербург, ул. Калинина, дом 2, корпус 4, литера А.