

Miniature Door Switch

D3DC

Long Stroke Actuator with Operating Position Marks

- Long stroke (7 mm) in a small package.
- Operating position marks make stroke settings easier.
- Easy assembly with a snap-fit panel mount design.
- Quick-connection terminals facilitate wiring.
- Available in a variety of colors.
- RoHS Compliant.

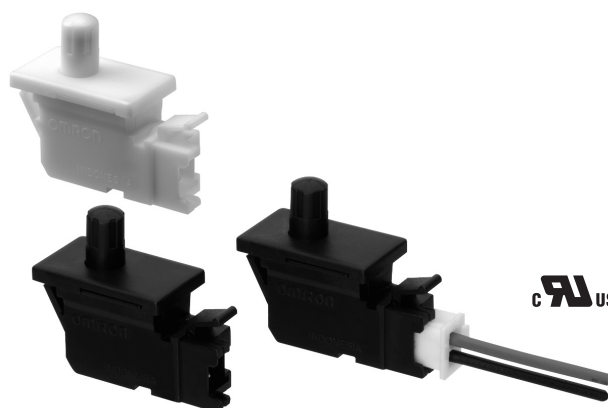

Ordering Information

List of Models

Contact Form		Model Name
SPST-NC	Black	D3DC-2
	White	D3DC-2-W
SPST-NO	Black	D3DC-3N
	White	D3DC-3N-W

Model Number Legend

D3DC -	<input type="checkbox"/>	<input type="checkbox"/>	1.	Contact Form	2.	Housing Color
	1	2		2: SPST-NC		Blank: Black
				3N: SPST-NO		-W: White

Specifications

Characteristics

Permissible Operating speed	0.5 to 1 mm/s
Permissible Operating frequency	Mechanical: 30 operations/minute, max. Electrical: 20 operations/minute, max.
Insulation resistance	100 M Ω min. (at 500 VDC with insulation tester)
Contact resistance	300 m Ω max.
Dielectric strength	600 VAC, 50/60 Hz for 1 min between terminals of the same polarity 1,500 VAC, 50/60 Hz for 1 min between current-carrying metal parts and ground
Vibration resistance (See note 2)	Malfunction: 10 to 55 Hz, 1.5-mm double amplitude
Shock resistance (See note 2)	Destruction: 500 m/s ² (approx. 50G) max. Malfunction: 100 m/s ² (approx. 10G) max.
Degree of protection	IEC IP00
Ambient operating temperature	-25°C to 85°C (at 60% RH max.) with no icing or condensation
Ambient operating humidity	85% max. (for 5°C to 35°C)
Life expectancy	Mechanical: 100,000 operations min. (30 operations per minute) Electrical: 100,000 operations min. (20 operations per minute)
Weight	Approx. 2 g

Note: 1. Data shown are of initial value.

2. The given values are for Free Position and Total Travel Position. The contacts do not open or close for more than 1 ms.

Ratings

Rated voltage	Resistive load
30 VDC	0.1 A

Note: The electrical rating applies under the following test conditions:

Ambient Temperature = 20 \pm 2°C, Ambient Humidity = 65 \pm 5%, Operating frequency = 20 operations/min.

Contact Specifications

Item	Specification
Specification	Rivet
Material	Silver
Gap (standard value)	0.3 mm
Minimum applicable load (see note)	1 mA at 5 VDC

Note: Minimum applicable loads are indicated by L-level standard reference values. This value represents the failure rate at a 60% (λ_{60}) reliability level (JIS C5003). The equation $\lambda_{60}=0.5 \times 10^{-6}$ / operations indicates that the estimated failure rate of less than 1/2,000,000 operations can be expected at a reliability level of 60%

Approved Standards

UL Recognized
CSA Certified (UL approval)

Rated voltage	Rated Load
30 VDC	0.1 A

Engineering Data

Panel Cutout Dimensions

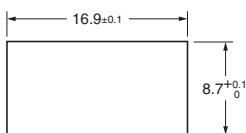

Note: Mounting plate thickness: 0.75 mm to 1.50 mm.

Contact Form

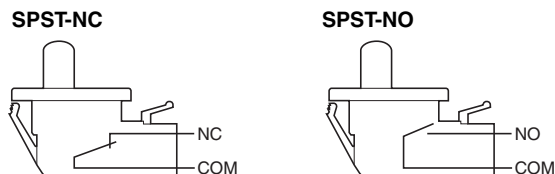

Dimensions and Operating Characteristics

Note: 1. Unless otherwise specified, all units are in millimeters and a tolerance of ± 0.4 mm applies to all dimensions
2. The operating characteristics are for operation in the A direction (indicated by the arrow)

D3DC-2
D3DC-3

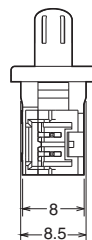
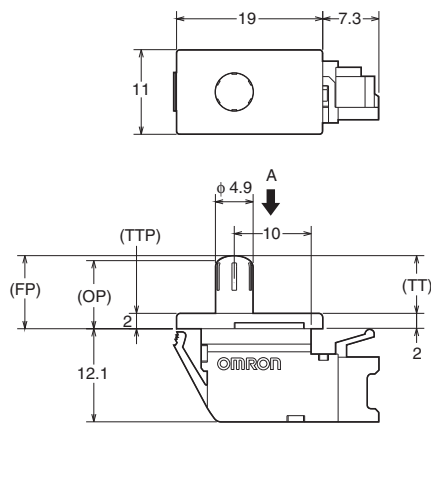

Model	D3DC-2 <input type="checkbox"/>	D3DC-3 <input type="checkbox"/>
OF max.	102 gf	
TT	7.0 mm (reference value)	
FP	9.5 (reference value)	
OP min.	6.7 mm	
TTP	2.0 mm (reference value)	

Precautions

Be sure to read the precautions and information common to all Snap Action and Detection Switches, contained in the Technical User's Guide, "Snap Action Switches, Technical Information" for correct use.

■ Correct Use

Mounting

This product does not have waterproof or drip-proof construction. Ensure that water does not enter the switch interior. In particular, do not use the switch in locations where water may be spilled or flow over the switch. Doing so may result in deterioration of the insulation.

Also, if the contact is kept open for long periods of time, it is recommended to use a sealed switch to prevent sulfuration of the contacts.

Pay attention to the creepage distance and clearance distance for insulation after wiring onto the terminals, when the mounting frame is made of metal.

Wiring

Do not use the switch with a large force applied to the connector or lead wire. Doing so may result in rattling or contact failure.

Storage Environment

Storing the switch in a plastic bag will help prevent discoloration due to sulfuration of the (silver-plated) terminals.

Do not use the switch in locations subject to harmful gases or to high temperatures or humidity levels. Depending on the location, it is recommended that switches be inspected between 3 and 6 months after the date of manufacture.

Micro Loads

Using a model for ordinary loads to switch microloads may result in faulty operation. Instead, use the models that are designed for microloads and that operate in the following range;

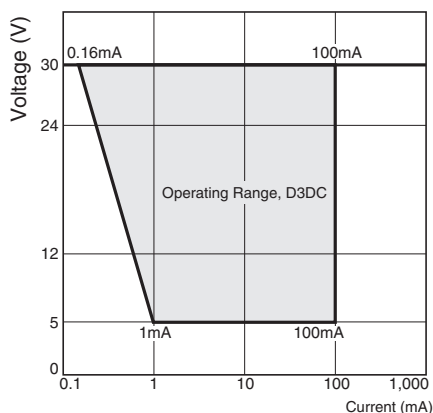

However, even when using microload models within the operating range shown above, if inrush current or inductive voltage spikes occur when the contact is opened or closed, then contact wear may increase and so decrease the service life. Therefore, insert a contact protection circuit where necessary.

Connectors

The terminals connect to JST's XA Connector.

The XA Connector consists of the following components.

Contact: SXA-001T-P0.6

Housing: XAP-02V-1

Omron does not sell the XA Connector.

Contact J.S.T. Manufacturing Co. for these connectors.

■ Cautions

Handling

Do not expose the switch to shocks, such as by dropping it. Doing so may damage or deform the switch.

Do not apply lubrication to the sliding parts, such as pushbuttons or actuators. Doing so may result in faulty operation or contact failure.

In order to ensure stable contact force for contacts, actuate beyond the recommended operating point (NO contact) and release to free position (NC contact).

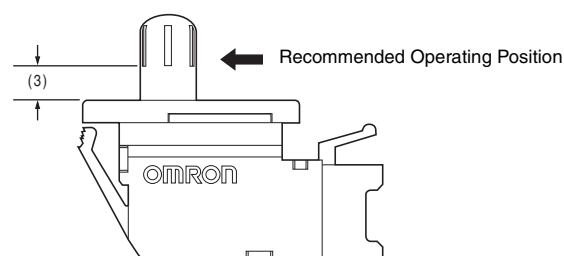

All sales are subject to Omron Electronic Components LLC standard terms and conditions of sale, which can be found at http://www.components.omron.com/components/web/webfiles.nsf/sales_terms.html

ALL DIMENSIONS SHOWN ARE IN MILLIMETERS.
To convert millimeters into inches, multiply by 0.03937. To convert grams into ounces, multiply by 0.03527.



**OMRON ELECTRONIC
COMPONENTS LLC**

55 E. Commerce Drive, Suite B
Schaumburg, IL 60173

847-882-2288

OMRON ON-LINE

Global - <http://www.omron.com>
USA - <http://www.components.omron.com>

Cat. No. X303-E-1a

09/12

Specifications subject to change without notice

Printed in USA



Компания «ЭлектроПласт» предлагает заключение долгосрочных отношений при поставках импортных электронных компонентов на взаимовыгодных условиях!

Наши преимущества:

- Оперативные поставки широкого спектра электронных компонентов отечественного и импортного производства напрямую от производителей и с крупнейших мировых складов;
- Поставка более 17-ти миллионов наименований электронных компонентов;
- Поставка сложных, дефицитных, либо снятых с производства позиций;
- Оперативные сроки поставки под заказ (от 5 рабочих дней);
- Экспресс доставка в любую точку России;
- Техническая поддержка проекта, помощь в подборе аналогов, поставка прототипов;
- Система менеджмента качества сертифицирована по Международному стандарту ISO 9001;
- Лицензия ФСБ на осуществление работ с использованием сведений, составляющих государственную тайну;
- Поставка специализированных компонентов (Xilinx, Altera, Analog Devices, Intersil, Interpoint, Microsemi, Aeroflex, Peregrine, Syfer, Eurofarad, Texas Instrument, Miteq, Cobham, E2V, MA-COM, Hittite, Mini-Circuits, General Dynamics и др.);

Помимо этого, одним из направлений компании «ЭлектроПласт» является направление «Источники питания». Мы предлагаем Вам помощь Конструкторского отдела:

- Подбор оптимального решения, техническое обоснование при выборе компонента;
- Подбор аналогов;
- Консультации по применению компонента;
- Поставка образцов и прототипов;
- Техническая поддержка проекта;
- Защита от снятия компонента с производства.



Как с нами связаться

Телефон: 8 (812) 309 58 32 (многоканальный)

Факс: 8 (812) 320-02-42

Электронная почта: org@eplast1.ru

Адрес: 198099, г. Санкт-Петербург, ул. Калинина, дом 2, корпус 4, литера А.