

Thyristor/Diode and Thyristor/Thyristor, 135 A to 160 A (New INT-A-PAK Power Modules)



New INT-A-PAK

FEATURES

- High voltage
- Electrically isolated by DBC ceramic (Al_2O_3)
- 3500 V_{RMS} isolating voltage
- Industrial standard package
- High surge capability
- Glass passivated chips
- Modules uses high voltage power thyristor/diodes in three basic configurations
- Simple mounting
- UL approved file E78996
- Compliant to RoHS directive 2002/95/EC
- Designed and qualified for multiple level



RoHS
COMPLIANT

PRODUCT SUMMARY

$I_{T(AV)}$	135 A to 160 A
-------------	----------------

APPLICATIONS

- DC motor control and drives
- Battery charges
- Welders
- Power converters
- Lighting control
- Heat and temperature control

MAJOR RATINGS AND CHARACTERISTICS

SYMBOL	CHARACTERISTICS	VSK.136..	VSK.142..	VSK.162..	UNITS
$I_{T(AV)}$	85 °C	135	140	160	A
$I_{T(RMS)}$		300	310	355	A
I_{TSM}	50 Hz	3200	4500	4870	
	60 Hz	3360	4712	5100	
I^2t	50 Hz	51.5	102	119	kA^2s
	60 Hz	47	92.5	108	
$I^2\sqrt{t}$		515.5	1013	1190	$kA^2\sqrt{s}$
V_{RRM}	Range	400 to 1600			V
T_J	Range	- 40 to 125			°C

ELECTRICAL SPECIFICATIONS

VOLTAGE RATINGS

TYPE NUMBER	VOLTAGE CODE	V_{RRM}/V_{DRM} , MAXIMUM REPETITIVE PEAK REVERSE VOLTAGE V	V_{RSM}/V_{DSM} , MAXIMUM NON-REPETITIVE PEAK REVERSE VOLTAGE V	I_{RRM}/I_{DRM} AT 125 °C mA
VSK.136 VSK.142 VSK.162	04	400	500	50
	08	800	900	
	12	1200	1300	
	14	1400	1500	
	16	1600	1700	

VSK.136..PbF, VSK.142..PbF, VSK.162..PbF Series



Vishay High Power Products

Thyristor/Diode and
Thyristor/Thyristor, 135 A to 160 A
(New INT-A-PAK Power Modules)

FORWARD CONDUCTION								
PARAMETER	SYMBOL	TEST CONDITIONS		VSK.136	VSK.142	VSK.162	UNITS	
Maximum average on-state current at case temperature	$I_{T(AV)}$	180° conduction, half sine wave		135	140	160	A	
				85	85	85	°C	
Maximum RMS on-state current	$I_{T(RMS)}$	As AC switch		300	310	355	A	
Maximum peak, one-cycle on-state, non-repetitive surge current	I_{TSM}	t = 10 ms	No voltage reapplied	3200	4500	4870		
		t = 8.3 ms	No voltage reapplied	3360	4712	5100		
		t = 10 ms	100 % V_{RRM} reapplied	2700	3785	4100		
		t = 8.3 ms	100 % V_{RRM} reapplied	2800	3963	4300		
Maximum I^2t for fusing	I^2t	t = 10 ms	No voltage reapplied	51.5	102	119		kA ² s
		t = 8.3 ms	No voltage reapplied	47	92.5	108		
		t = 10 ms	100 % V_{RRM} reapplied	36.5	71.6	84		
		t = 8.3 ms	100 % V_{RRM} reapplied	33.3	65.4	76.7		
Maximum $I^2\sqrt{t}$ for fusing	$I^2\sqrt{t}$	t = 0.1 ms to 10 ms, no voltage reapplied		515.5	1013	1190	kA ² √s	
Low level value of threshold voltage	$V_{T(TO)1}$	(16.7 % $\times \pi \times I_{T(AV)} < I < \pi \times I_{T(AV)}$, T_J maximum)		0.86	0.83	0.8	V	
High level value of threshold voltage	$V_{T(TO)2}$	(I $> \pi \times I_{T(AV)}$, T_J maximum)		1.05	1	0.98		
Low level value on-state slope resistance	r_{t1}	(16.7 % $\times \pi \times I_{T(AV)} < I < \pi \times I_{T(AV)}$, T_J maximum)		2.02	1.78	1.67	mΩ	
High level value on-state slope resistance	r_{t2}	(I $> \pi \times I_{T(AV)}$, T_J maximum)		1.65	1.43	1.38		
Maximum on-state voltage drop	V_{TM}	$I_{TM} = \pi \times I_{T(AV)}$, $T_J = 25^\circ\text{C}$, 180° conduction		1.57	1.55	1.54	V	
Maximum forward voltage drop	V_{FM}	$I_{TM} = \pi \times I_{T(AV)}$, $T_J = 25^\circ\text{C}$, 180° conduction		1.57	1.55	1.54	V	
Maximum holding current	I_H	Anode supply = 6 V initial $I_T = 30$ A, $T_J = 25^\circ\text{C}$		200			mA	
Maximum latching current	I_L	Anode supply = 6 V resistive load = 1 Ω Gate pulse: 10 V, 100 μs, $T_J = 25^\circ\text{C}$		400				

SWITCHING						
PARAMETER	SYMBOL	TEST CONDITIONS		VALUES		UNITS
Typical delay time	t_{gd}	$T_J = 25^\circ\text{C}$	Gate current = 1 A, $di_g/dt = 1$ A/μs $V_d = 0.67 \% V_{DRM}$	1		μs
Typical rise time	t_{gr}			2		
Typical turn-off time	t_q	$I_{TM} = 300$ A, - $di/dt = 15$ A/μs; $T_J = T_J$ maximum $V_R = 50$ V; $dV/dt = 20$ V/μs; gate 0 V, 100 Ω		50 to 200		

BLOCKING						
PARAMETER	SYMBOL	TEST CONDITIONS		VALUES		UNITS
Maximum peak reverse and off-state leakage current	I_{RRM} , I_{DRM}	$T_J = 125^\circ\text{C}$		50		mA
RMS insulation voltage	V_{INS}	50 Hz, circuit to base, all terminals shorted, t = 1 s		3500		V
Critical rate of rise of off-state voltage	dV/dt	$T_J = T_J$ maximum, exponential to 67 % rated V_{DRM}		1000		V/μs



VSK.136..PbF, VSK.142..PbF, VSK.162..PbF Series

Thyristor/Diode and Vishay High Power Products
 Thyristor/Thyristor, 135 A to 160 A
 (New INT-A-PAK Power Modules)

TRIGGERING					
PARAMETER	SYMBOL	TEST CONDITIONS		VALUES	UNITS
Maximum peak gate power	P_{GM}	$t_p \leq 5$ ms, $T_J = T_J$ maximum		12	W
Maximum average gate power	$P_{G(AV)}$	f = 50 Hz, $T_J = T_J$ maximum		3	
Maximum peak gate current	I_{GM}	$t_p \leq 5$ ms, $T_J = T_J$ maximum		3	A
Maximum peak negative gate voltage	$-V_{GT}$			10	
Maximum required DC gate voltage to trigger	V_{GT}	$T_J = -40$ °C	Anode supply = 6 V, resistive load; $R_a = 1$ Ω	4	V
		$T_J = 25$ °C		2.5	
		$T_J = T_J$ maximum		1.7	
Maximum required DC gate current to trigger	I_{GT}	$T_J = -40$ °C		270	mA
		$T_J = 25$ °C		150	
		$T_J = T_J$ maximum		80	
Maximum gate voltage that will not trigger	V_{GD}	$T_J = T_J$ maximum, rated V_{DRM} applied		0.3	V
Maximum gate current that will not trigger	I_{GD}			10	mA
Maximum rate of rise of turned-on current	di/dt	$T_J = T_J$ maximum, $I_{TM} = 400$ A rated V_{DRM} applied		300	A/μs

THERMAL AND MECHANICAL SPECIFICATIONS					
PARAMETER	SYMBOL	TEST CONDITIONS	VALUES	UNITS	
Maximum junction operating temperature range	T_J		- 40 to 125	°C	
Maximum storage temperature range	T_{Stg}		- 40 to 150		
Maximum thermal resistance, junction to case per junction	R_{thJC}	DC operation	0.18	0.16	K/W
Maximum thermal resistance, case to heatsink per module	R_{thCS}	Mounting surface, smooth, flat and greased	0.05		
Mounting torque ± 10 %	IAP to heatsink busbar to IAP	A mounting compound is recommended and the torque should be rechecked after a period of 3 hours to allow for the spread of the compound. Lubricated threads.	4 to 6		Nm
Approximate weight			200	7.1	g oz.
Case style			New INT-A-PAK		

ΔR CONDUCTION PER JUNCTION											
DEVICES	SINUSOIDAL CONDUCTION AT T_J MAXIMUM					RECTANGULAR CONDUCTION AT T_J MAXIMUM					UNITS
	180°	120°	90°	60°	30°	180°	120°	90°	60°	30°	
VSK.136	0.007	0.01	0.013	0.0155	0.017	0.009	0.012	0.014	0.015	0.017	K/W
VSK.142	0.0019	0.0019	0.0020	0.0020	0.0021	0.0018	0.0022	0.0023	0.0023	0.0020	
VSK.162	0.0030	0.0031	0.0032	0.0033	0.0034	0.0029	0.0036	0.0039	0.0041	0.0040	

Note

- Table shows the increment of thermal resistance R_{thJC} when devices operate at different conduction angles than DC



Fig. 1 - Current Ratings Characteristics



Fig. 4 - On-State Power Loss Characteristics



Fig. 2 - Current Ratings Characteristics



Fig. 5 - Maximum Non-Repetitive Surge Current



Fig. 3 - On-State Power Loss Characteristics



Fig. 6 - Maximum Non-Repetitive Surge Current



VSK.136..PbF, VSK.142..PbF, VSK.162..PbF Series

Thyristor/Diode and
Thyristor/Thyristor, 135 A to 160 A
(New INT-A-PAK Power Modules)

Vishay High Power Products



Fig. 7 - On-State Power Loss Characteristics

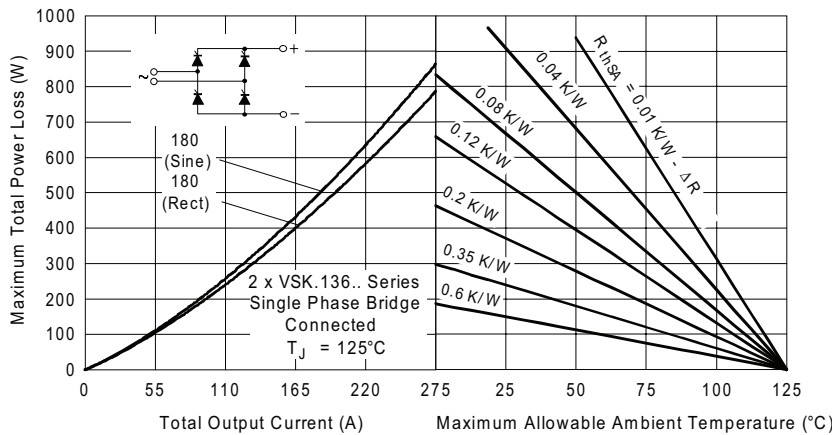

Fig. 8 - On-State Power Loss Characteristics

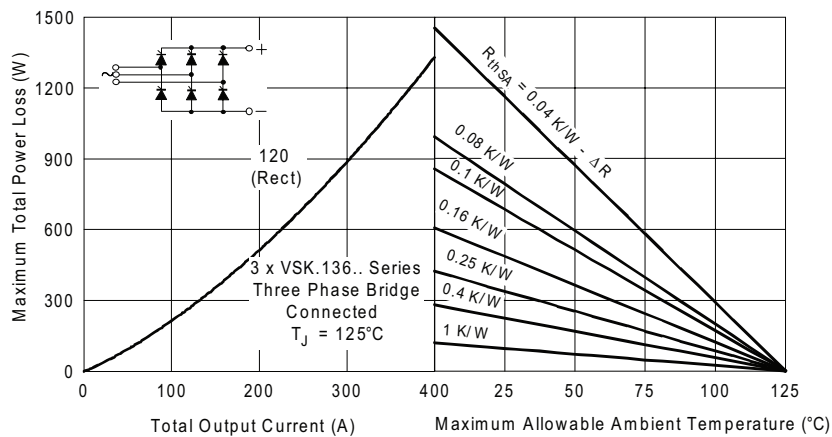

Fig. 9 - On-State Power Loss Characteristics



Fig. 10 - Current Ratings Characteristics



Fig. 13 - On-State Power Loss Characteristics



Fig. 11 - Current Ratings Characteristics



Fig. 14 - Maximum Non-Repetitive Surge Current

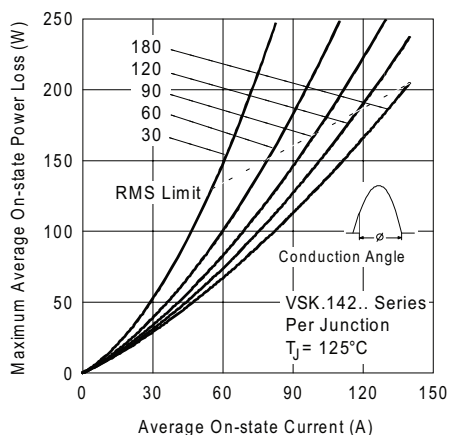

Fig. 12 - On-State Power Loss Characteristics

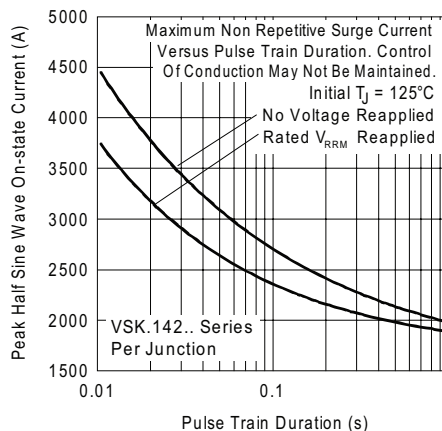

Fig. 15 - Maximum Non-Repetitive Surge Current



VSK.136..PbF, VSK.142..PbF, VSK.162..PbF Series

Thyristor/Diode and Thyristor/Thyristor, 135 A to 160 A
 Vishay High Power Products
 (New INT-A-PAK Power Modules)



Fig. 16 - On-State Power Loss Characteristics



Fig. 17 - On-State Power Loss Characteristics



Fig. 18 - On-State Power Loss Characteristics



Fig. 19 - Current Ratings Characteristics



Fig. 22 - On-State Power Loss Characteristics



Fig. 20 - Current Ratings Characteristics



Fig. 23 - Maximum Non-Repetitive Surge Current



Fig. 21 - On-State Power Loss Characteristics



Fig. 24 - Maximum Non-Repetitive Surge Current



VSK.136..PbF, VSK.142..PbF, VSK.162..PbF Series

Thyristor/Diode and Thyristor/Thyristor, 135 A to 160 A
 Vishay High Power Products
 (New INT-A-PAK Power Modules)

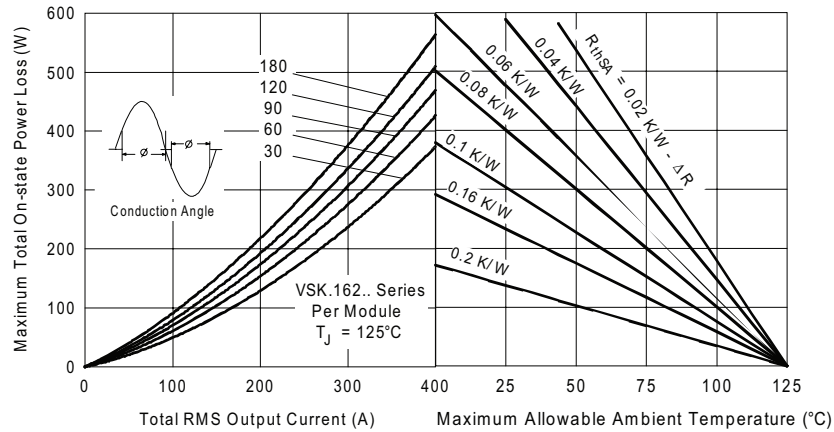

Fig. 25 - On-State Power Loss Characteristics

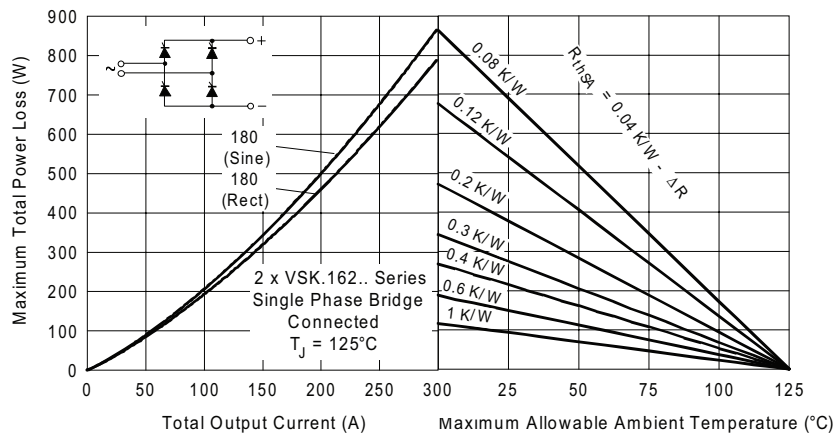

Fig. 26 - On-State Power Loss Characteristics



Fig. 27 - On-State Power Loss Characteristics

VSK.136..PbF, VSK.142..PbF, VSK.162..PbF Series



Vishay High Power Products

Thyristor/Diode and
Thyristor/Thyristor, 135 A to 160 A
(New INT-A-PAK Power Modules)



Fig. 28 - On-State Voltage Drop Characteristics



Fig. 31 - Thermal Impedance Z_{thJC} Characteristics



Fig. 29 - On-State Voltage Drop Characteristics



Fig. 32 - Thermal Impedance Z_{thJC} Characteristics



Fig. 30 - On-State Voltage Drop Characteristics



Fig. 33 - Thermal Impedance Z_{thJC} Characteristics



VSK.136..PbF, VSK.142..PbF, VSK.162..PbF Series

Thyristor/Diode and Vishay High Power Products
 Thyristor/Thyristor, 135 A to 160 A
 (New INT-A-PAK Power Modules)



Fig. 34 - Gate Characteristics

ORDERING INFORMATION TABLE

Device code	VSK	T	162	/	16	PbF
	①	②	③		④	⑤
	1	-	Module type		2	-
	2	-	Circuit configuration		3	-
	3	-	Current rating: $I_{T(AV)}$		4	-
	4	-	Voltage code x 100 = V_{RRM}		5	-
	5	-	PbF = Lead (Pb)-free			

Note

- To order the optional hardware go to www.vishay.com/doc?95172

CIRCUIT CONFIGURATION



LINKS TO RELATED DOCUMENTS

Dimensions

www.vishay.com/doc?95067

INT-A-PAK IGBT/Thyristor

DIMENSIONS in millimeters (inches)





Disclaimer

ALL PRODUCT, PRODUCT SPECIFICATIONS AND DATA ARE SUBJECT TO CHANGE WITHOUT NOTICE TO IMPROVE RELIABILITY, FUNCTION OR DESIGN OR OTHERWISE.

Vishay Intertechnology, Inc., its affiliates, agents, and employees, and all persons acting on its or their behalf (collectively, "Vishay"), disclaim any and all liability for any errors, inaccuracies or incompleteness contained in any datasheet or in any other disclosure relating to any product.

Vishay makes no warranty, representation or guarantee regarding the suitability of the products for any particular purpose or the continuing production of any product. To the maximum extent permitted by applicable law, Vishay disclaims (i) any and all liability arising out of the application or use of any product, (ii) any and all liability, including without limitation special, consequential or incidental damages, and (iii) any and all implied warranties, including warranties of fitness for particular purpose, non-infringement and merchantability.

Statements regarding the suitability of products for certain types of applications are based on Vishay's knowledge of typical requirements that are often placed on Vishay products in generic applications. Such statements are not binding statements about the suitability of products for a particular application. It is the customer's responsibility to validate that a particular product with the properties described in the product specification is suitable for use in a particular application. Parameters provided in datasheets and/or specifications may vary in different applications and performance may vary over time. All operating parameters, including typical parameters, must be validated for each customer application by the customer's technical experts. Product specifications do not expand or otherwise modify Vishay's terms and conditions of purchase, including but not limited to the warranty expressed therein.

Except as expressly indicated in writing, Vishay products are not designed for use in medical, life-saving, or life-sustaining applications or for any other application in which the failure of the Vishay product could result in personal injury or death. Customers using or selling Vishay products not expressly indicated for use in such applications do so at their own risk. Please contact authorized Vishay personnel to obtain written terms and conditions regarding products designed for such applications.

No license, express or implied, by estoppel or otherwise, to any intellectual property rights is granted by this document or by any conduct of Vishay. Product names and markings noted herein may be trademarks of their respective owners.

Material Category Policy

Vishay Intertechnology, Inc. hereby certifies that all its products that are identified as RoHS-Compliant fulfill the definitions and restrictions defined under Directive 2011/65/EU of The European Parliament and of the Council of June 8, 2011 on the restriction of the use of certain hazardous substances in electrical and electronic equipment (EEE) - recast, unless otherwise specified as non-compliant.

Please note that some Vishay documentation may still make reference to RoHS Directive 2002/95/EC. We confirm that all the products identified as being compliant to Directive 2002/95/EC conform to Directive 2011/65/EU.

Vishay Intertechnology, Inc. hereby certifies that all its products that are identified as Halogen-Free follow Halogen-Free requirements as per JEDEC JS709A standards. Please note that some Vishay documentation may still make reference to the IEC 61249-2-21 definition. We confirm that all the products identified as being compliant to IEC 61249-2-21 conform to JEDEC JS709A standards.



Компания «ЭлектроПласт» предлагает заключение долгосрочных отношений при поставках импортных электронных компонентов на взаимовыгодных условиях!

Наши преимущества:

- Оперативные поставки широкого спектра электронных компонентов отечественного и импортного производства напрямую от производителей и с крупнейших мировых складов;
- Поставка более 17-ти миллионов наименований электронных компонентов;
- Поставка сложных, дефицитных, либо снятых с производства позиций;
- Оперативные сроки поставки под заказ (от 5 рабочих дней);
- Экспресс доставка в любую точку России;
- Техническая поддержка проекта, помощь в подборе аналогов, поставка прототипов;
- Система менеджмента качества сертифицирована по Международному стандарту ISO 9001;
- Лицензия ФСБ на осуществление работ с использованием сведений, составляющих государственную тайну;
- Поставка специализированных компонентов (Xilinx, Altera, Analog Devices, Intersil, Interpoint, Microsemi, Aeroflex, Peregrine, Syfer, Eurofarad, Texas Instrument, Miteq, Cobham, E2V, MA-COM, Hittite, Mini-Circuits, General Dynamics и др.);

Помимо этого, одним из направлений компании «ЭлектроПласт» является направление «Источники питания». Мы предлагаем Вам помощь Конструкторского отдела:

- Подбор оптимального решения, техническое обоснование при выборе компонента;
- Подбор аналогов;
- Консультации по применению компонента;
- Поставка образцов и прототипов;
- Техническая поддержка проекта;
- Защита от снятия компонента с производства.



Как с нами связаться

Телефон: 8 (812) 309 58 32 (многоканальный)

Факс: 8 (812) 320-02-42

Электронная почта: org@eplast1.ru

Адрес: 198099, г. Санкт-Петербург, ул. Калинина, дом 2, корпус 4, литера А.