

Step-Down switching regulator IC with Over Current Protection

■ GENERAL DESCRIPTION

The **NJU7640** is a low voltage operation high-speed switching regulator control IC for step-down converter, with a pulse-by-pulse over-current protection. The pulse-by-pulse over-current protection circuit can limit the over current in switching operation.

It incorporates a totem pole output, which can drive an external MOS-FET easily. It also has a soft-start function and dead time control and their times are all adjustable with external parts.

The NJU7640 is available in a small and thin 8-lead MSOP (TVSP) package.

■ FEATURES

- PWM switching control
- Pulse-by-pulse over current protection
- Operating Voltage 2.2V to 8V
- Wide Oscillator Range 300kHz to 1MHz
- Maximum Duty Cycle 100%
- Quiescent Current 800 μ A typ.
- Soft-Start Function Internal : 16ms typ. or adjustable
- Dead Time Control
- C-MOS Technology
- Package Outline NJU7640RB1 : MSOP8 (TVSP8)*

*MEET JEDEC MO-187-DA / THIN TYPE

■ PACKAGE OUTLINE



NJU7640RB1
(MSOP8 (TVSP8))

■ PRODUCT VARIATION

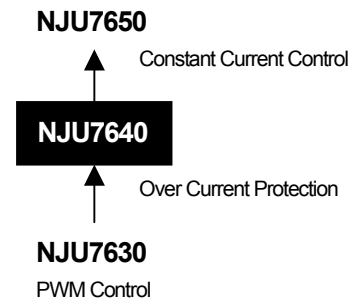

■ PIN CONFIGURATION

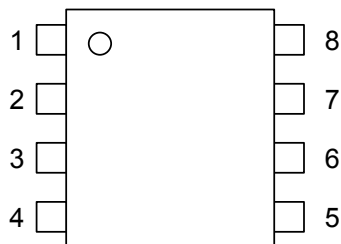

NJU7640RB1

PIN FUNCTION

1. OUT
2. V⁺
3. FB
4. IN-
5. SENSE
6. DTC
7. RT
8. GND

NJU7640

■ BLOCK DIAGRAM

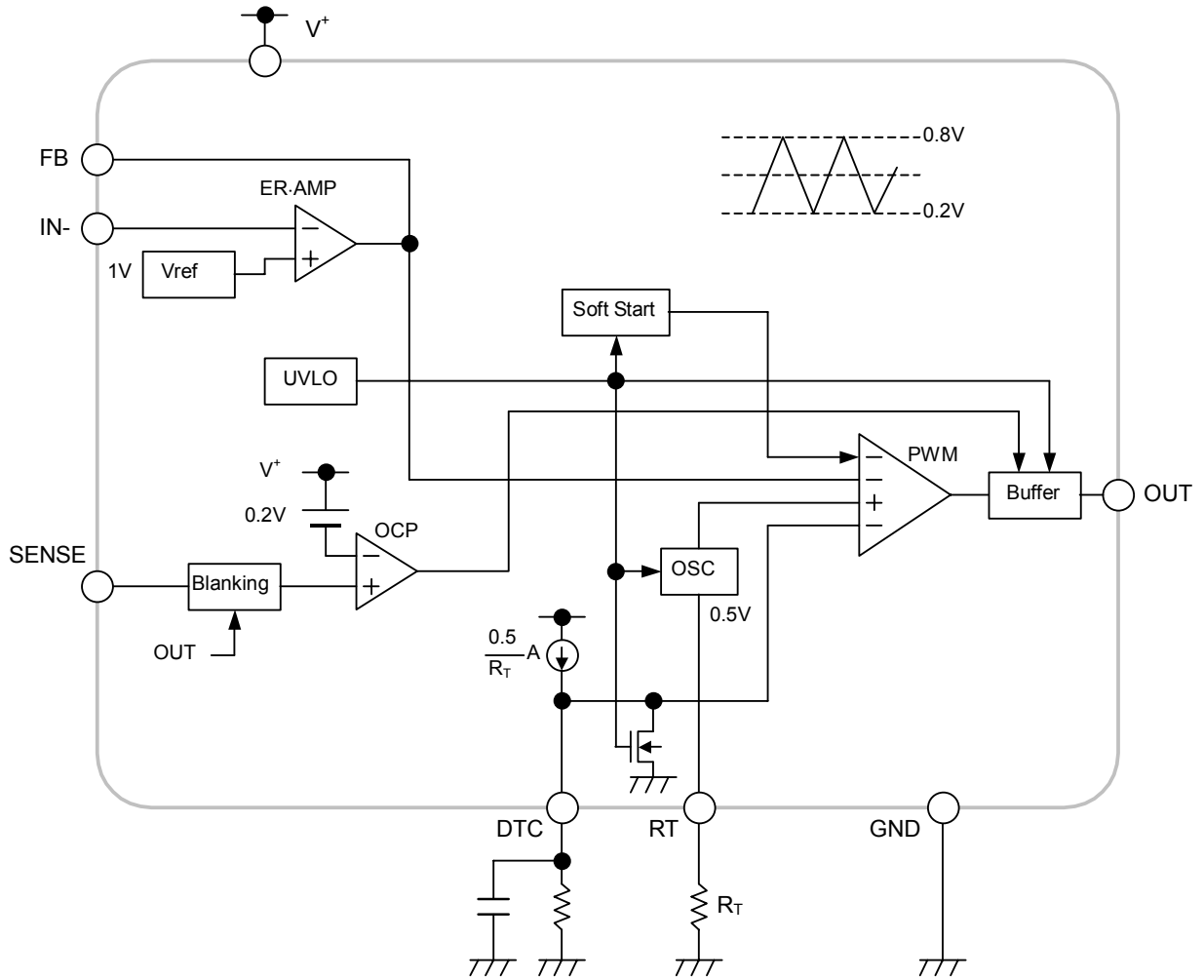

■ ABSOLUTE MAXIMUM RATINGS

(Ta=25°C)

PARAMETER	SYMBOL	MAXIMUM RATINGS	UNIT
Supply Voltage	V ⁺	+9	V
Output Pin Current	I _O	±50	mA
Power Dissipation	P _D	MSOP8 (TVSP8) :320	mW
Operating Temperature Range	T _{OPR}	-40 to +85	°C
Storage Temperature Range	T _{STG}	-40 to +125	°C

■ RECOMMENDED OPERATING CONDITIONS

(Ta=25°C)

PARAMETER	SYMBOL	MIN.	TYP.	MAX.	UNIT
Operating Voltage	V ⁺	2.2	–	8	V
Oscillator Timing Resistor	R _T	30	47	120	kΩ
Oscillation Frequency	f _{OSC}	300	700	1,000	kHz

■ ELECTRICAL CHARACTERISTICS

(V⁺=3.3V, R_T=47kΩ, Ta=25°C)

PARAMETER	SYMBOL	TEST CONDITION	MIN.	TYP.	MAX.	UNIT
Under Voltage Lockout Block						
ON Threshold Voltage	V _{T_ON}	V ⁺ = L → H	1.9	2.0	2.1	V
OFF Threshold Voltage	V _{T_OFF}	V ⁺ = H → L	1.8	1.9	2.0	V
Hysteresis Voltage	V _{HYS}		60	100	–	mV
Soft Start Block						
Soft Start Time	T _{SS}	V _{T_ON} → Duty=80%	8	16	24	ms
Over Current Protection Block						
Current Limit Sense Voltage	V _{SENSE}	Voltage between V ⁺ -SENSE pin	0.17	0.2	0.23	V
Delay Time	T _{DELAY}	V _{SENSE} +0.1V Delay time to OUT	–	160	–	ns
Sense Blanking Time	T _{BLANK}		–	90	–	ns
Oscillator Block						
RT Pin Voltage	V _{RT}		-5%	0.5	+5%	V
Oscillation Frequency	f _{OSC}		630	700	770	kHz
Oscillate Supply Voltage Fluctuations	f _{DV}	V ⁺ =2.2V to 8V	–	1	–	%
Oscillate Temperature Fluctuations	f _{DT}	Ta=-40°C to +85°C	–	3	–	%

NJU7640

■ ELECTRICAL CHARACTERISTICS

($V^+=3.3V$, $R_T=47k\Omega$, $T_a=25^\circ C$)

PARAMETER	SYMBOL	TEST CONDITION	MIN.	TYP.	MAX.	UNIT
Error Amplifier Block						
Reference Voltage	V_B		-1.0%	1.00	+1.0%	V
Input Bias Current	I_B		-0.1	–	0.1	μA
Open Loop Gain	A_V		–	80	–	dB
Gain Bandwidth Product	G_B		–	1	–	MHz
Output Source Current	I_{OM+1}	$V_{FB}=1V$, $V_{IN-}=0.9V$	25	55	95	mA
	I_{OM+2}	$V_{FB}=1V$, $V_{IN-}=0.9V$, $V^+=2.2V$	4	9	16	mA
Output Sink Current	I_{OM-}	$V_{FB}=1V$, $V_{IN-}=1.1V$	0.10	0.16	0.22	mA
PWM Compare Block						
Input Threshold Voltage	V_{T_0}	Duty=0%	0.16	0.22	0.28	V
	$V_{T_{50}}$	Duty=50%	0.44	0.5	0.56	V
Maximum Duty Cycle	M_{AXDUTY_1}	$V_{FB}=0.9V$	100	–	–	%
	M_{AXDUTY_2}	$V_{FB}=0.9V$, $R_{DTC}=47k\Omega$	40	50	60	%
Output Block						
Output High Level ON Resistance	R_{OH}	$I_O=-20mA$	–	10	20	Ω
Output Low Level ON Resistance	R_{OL}	$I_O=+20mA$	–	5	10	Ω
General Characteristics						
Quiescent Current	I_{DD}	$R_L=Non\ Load$	–	800	1200	μA

■ TYPICAL APPLICATIONS

Step-Down Converter

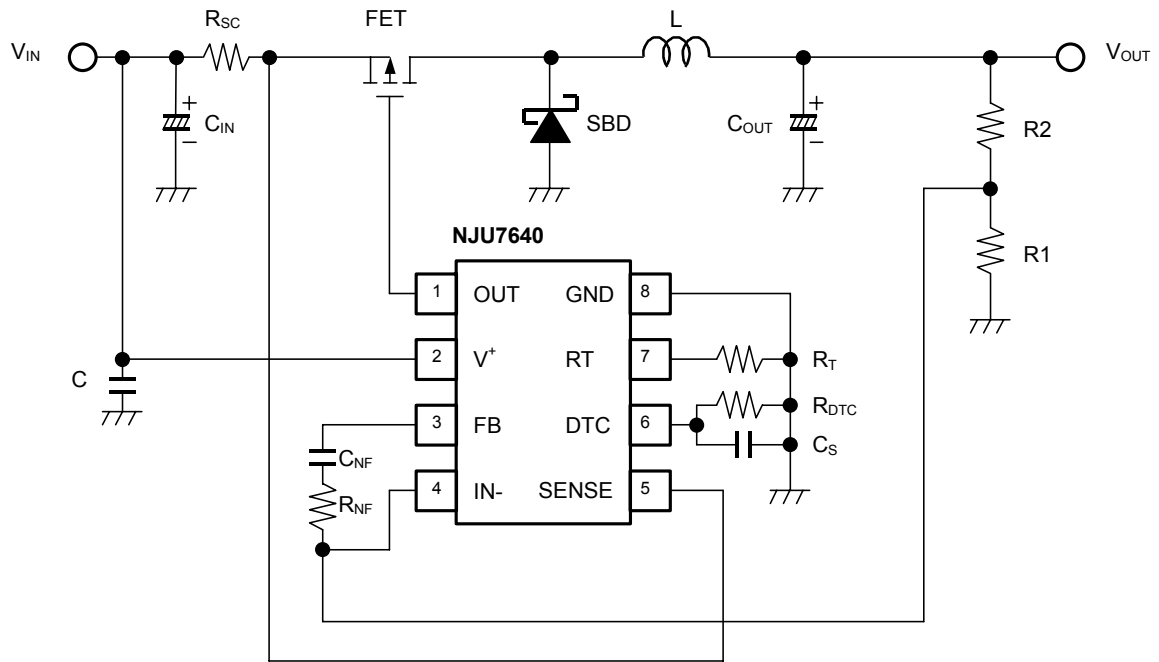

■ TYPICAL CHARACTERISTICS

Oscillation Frequency vs. Timing Resistance
($V^+ = 3.3V$, $T_a = 25^\circ C$)

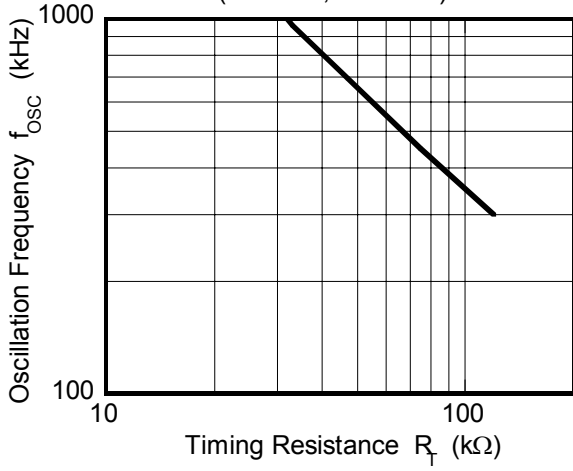

Oscillation Frequency vs. Operating Voltage
($R_T = 47k\Omega$, $T_a = 25^\circ C$)

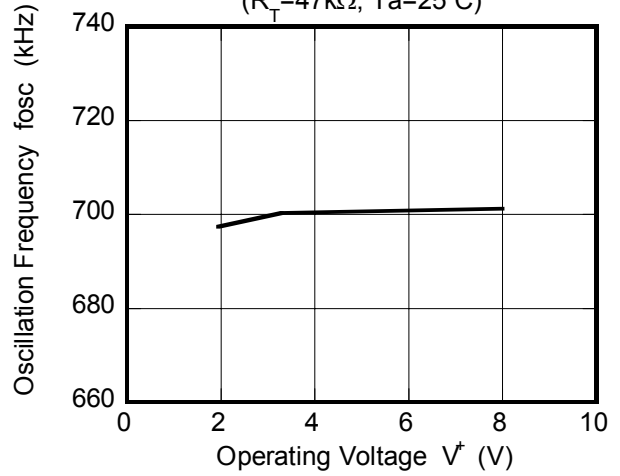

Duty Cycle vs. R_{DTC}

($V^+ = 3.3V$, $R_T = 47k\Omega$, $T_a = 25^\circ C$)

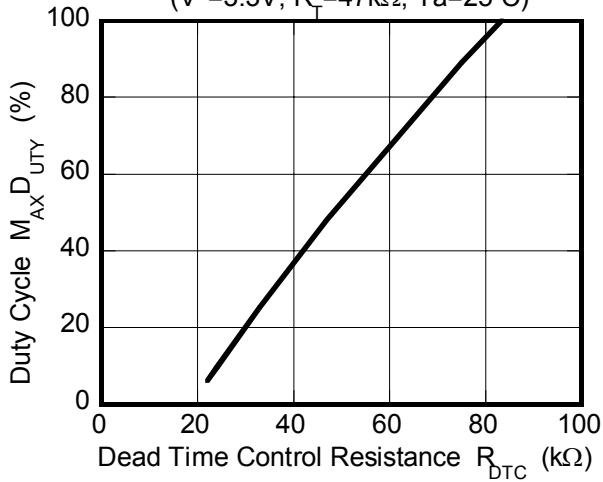

Duty Cycle vs. Current Limit Sense Voltage

($V^+ = 3.3V$, $R_T = 47k\Omega$, $T_a = 25^\circ C$)

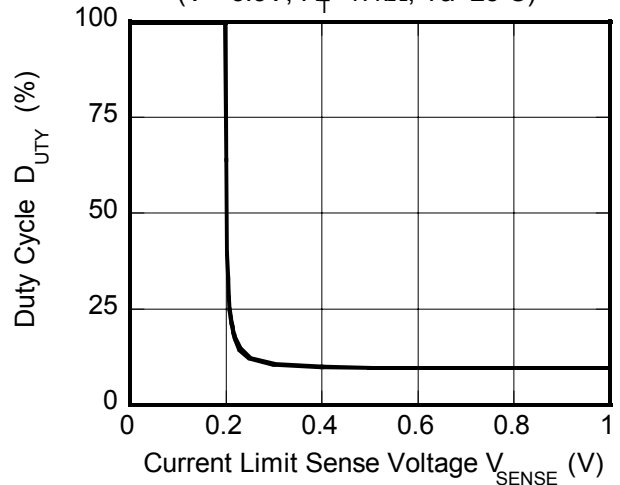

■ TYPICAL CHARACTERISTICS

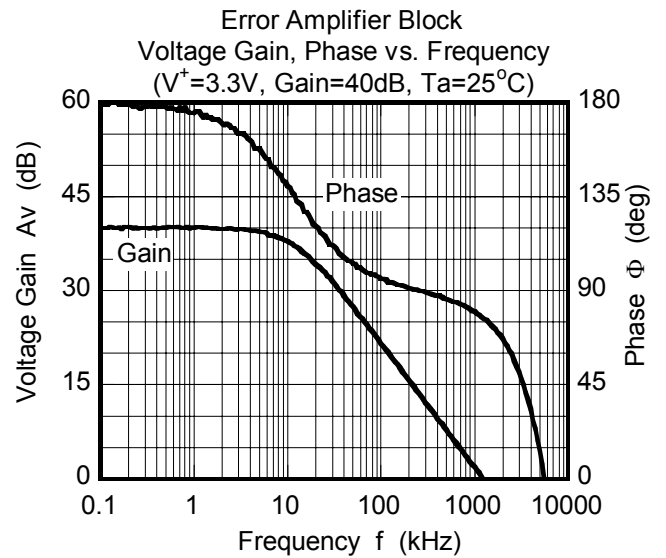
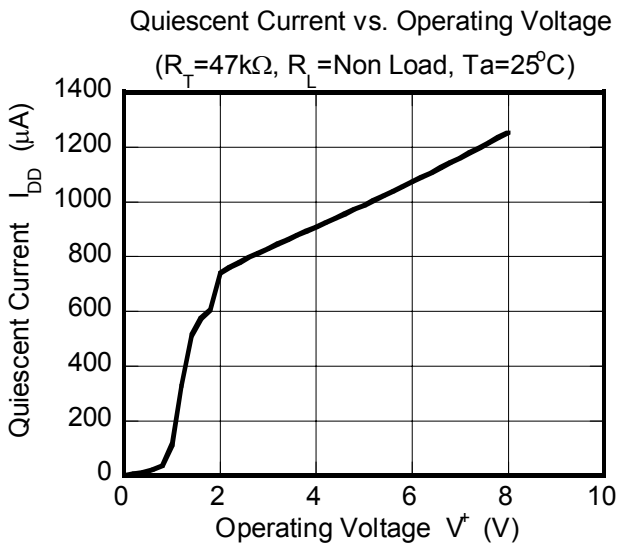
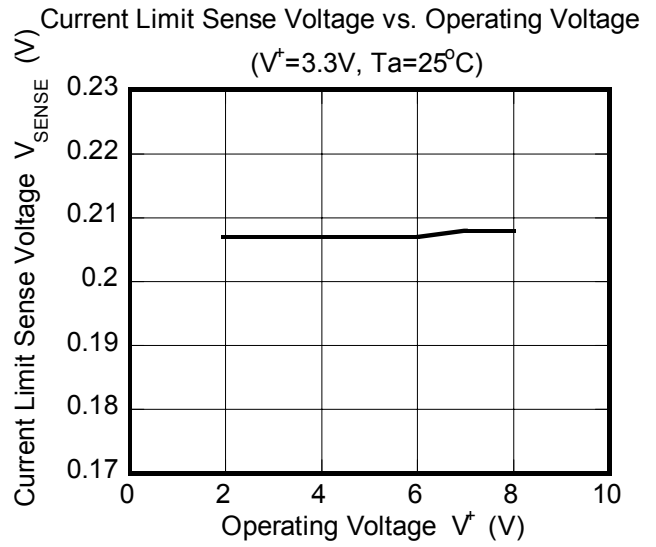
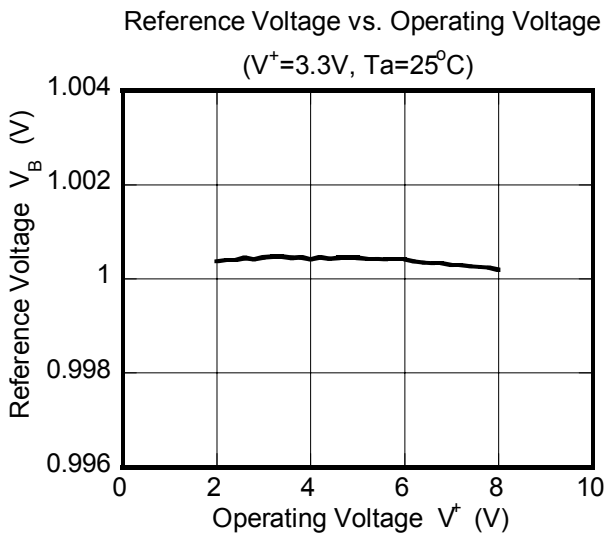

■ TYPICAL CHARACTERISTICS

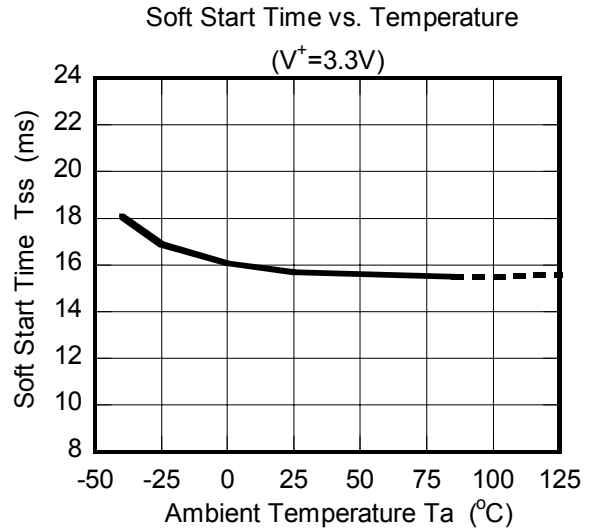
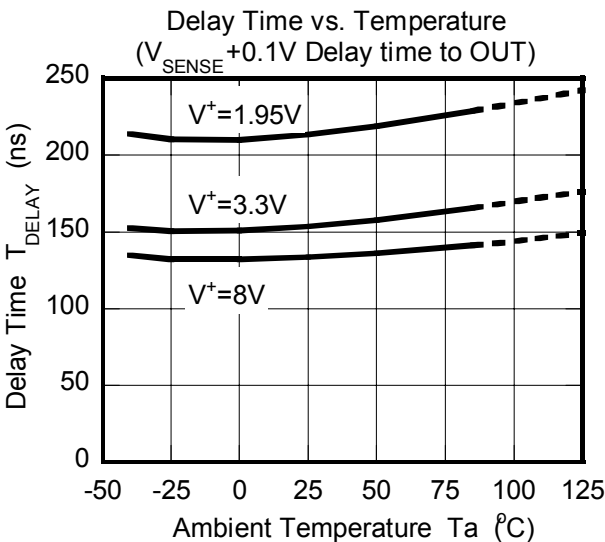
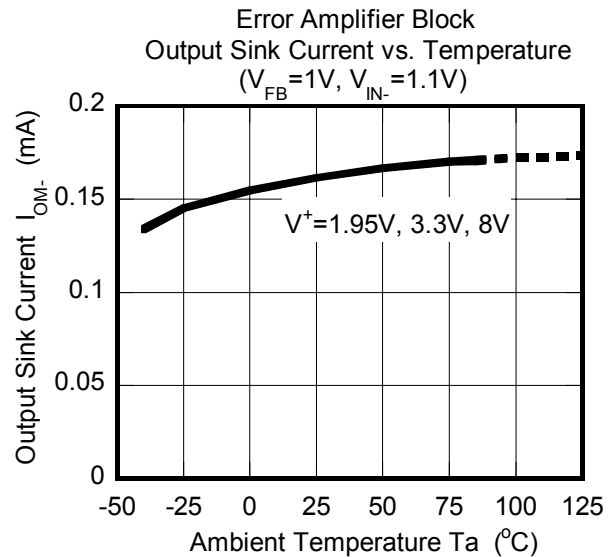
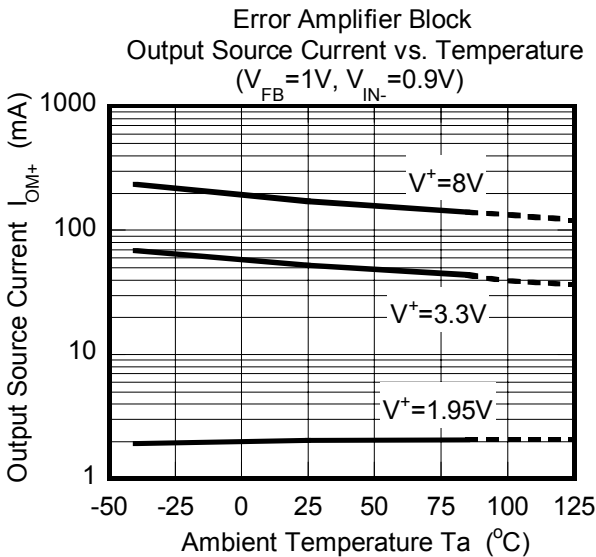
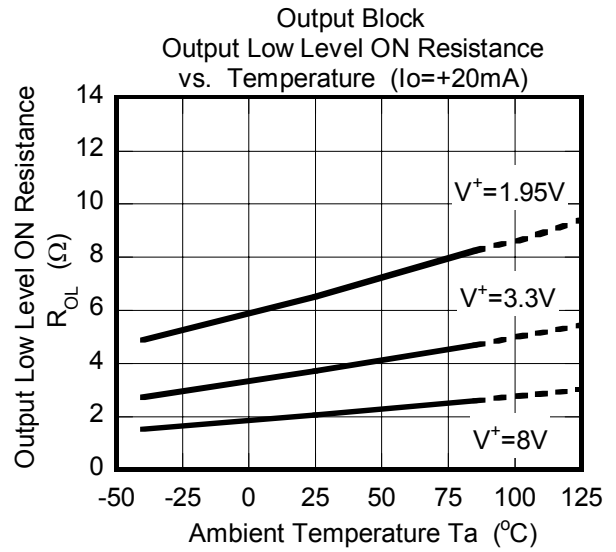
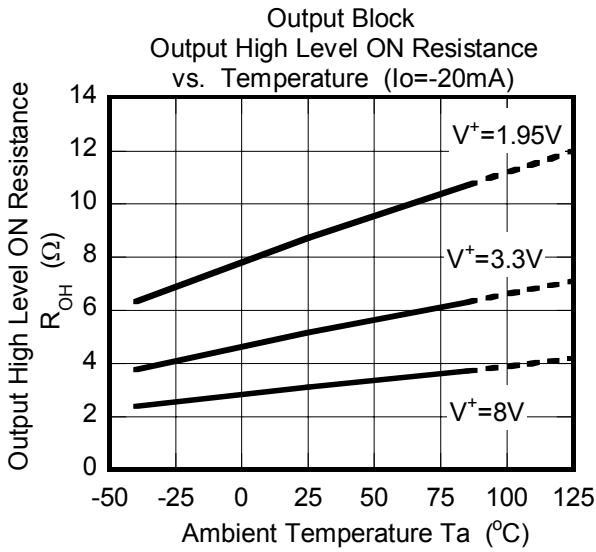

■ TYPICAL CHARACTERISTICS

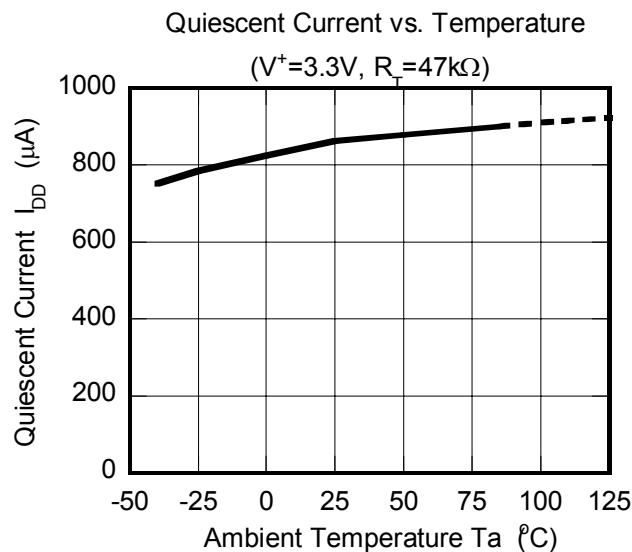
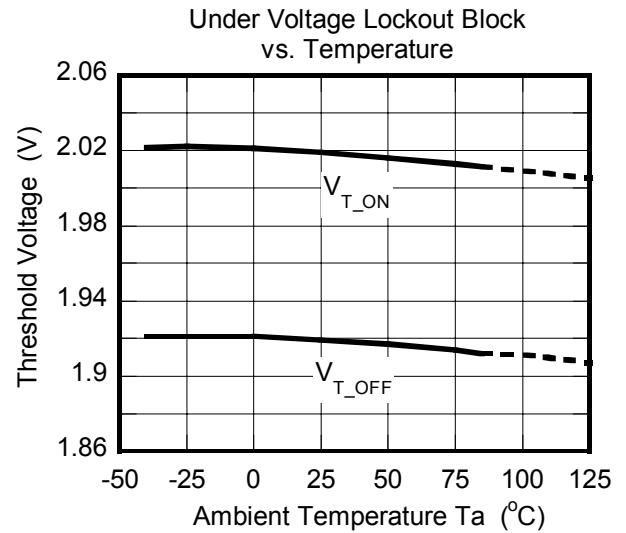
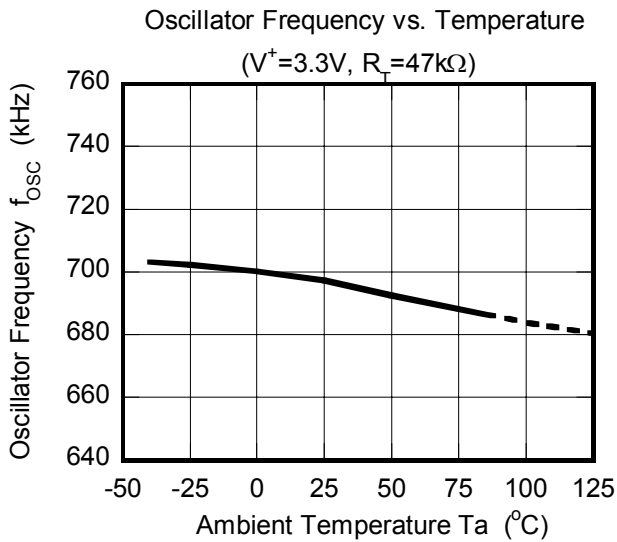
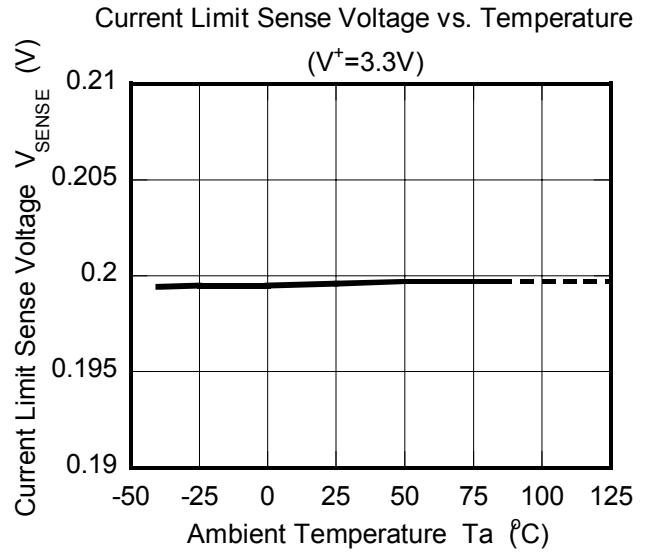
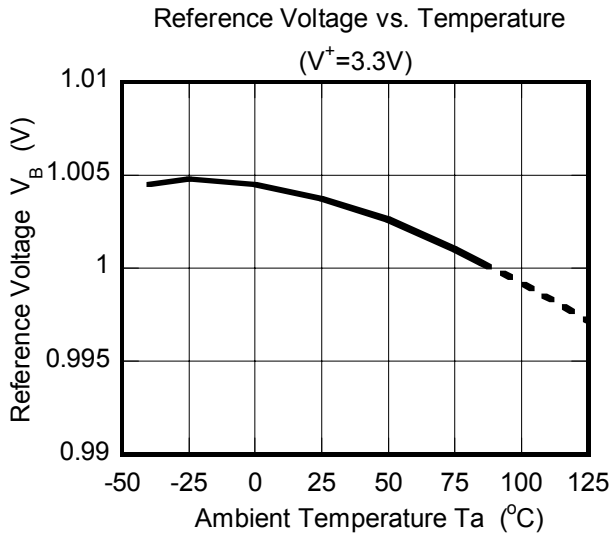

MEMO

[CAUTION]

The specifications on this databook are only given for information, without any guarantee as regards either mistakes or omissions. The application circuits in this databook are described only to show representative usages of the product and not intended for the guarantee or permission of any right including the industrial rights.

Mouser Electronics

Authorized Distributor

Click to View Pricing, Inventory, Delivery & Lifecycle Information:

[NJR:](#)

[NJU7640RB1-TE1](#)



Компания «ЭлектроПласт» предлагает заключение долгосрочных отношений при поставках импортных электронных компонентов на взаимовыгодных условиях!

Наши преимущества:

- Оперативные поставки широкого спектра электронных компонентов отечественного и импортного производства напрямую от производителей и с крупнейших мировых складов;
- Поставка более 17-ти миллионов наименований электронных компонентов;
- Поставка сложных, дефицитных, либо снятых с производства позиций;
- Оперативные сроки поставки под заказ (от 5 рабочих дней);
- Экспресс доставка в любую точку России;
- Техническая поддержка проекта, помощь в подборе аналогов, поставка прототипов;
- Система менеджмента качества сертифицирована по Международному стандарту ISO 9001;
- Лицензия ФСБ на осуществление работ с использованием сведений, составляющих государственную тайну;
- Поставка специализированных компонентов (Xilinx, Altera, Analog Devices, Intersil, Interpoint, Microsemi, Aeroflex, Peregrine, Syfer, Eurofarad, Texas Instrument, Miteq, Cobham, E2V, MA-COM, Hittite, Mini-Circuits, General Dynamics и др.);

Помимо этого, одним из направлений компании «ЭлектроПласт» является направление «Источники питания». Мы предлагаем Вам помощь Конструкторского отдела:

- Подбор оптимального решения, техническое обоснование при выборе компонента;
- Подбор аналогов;
- Консультации по применению компонента;
- Поставка образцов и прототипов;
- Техническая поддержка проекта;
- Защита от снятия компонента с производства.



Как с нами связаться

Телефон: 8 (812) 309 58 32 (многоканальный)

Факс: 8 (812) 320-02-42

Электронная почта: org@eplast1.ru

Адрес: 198099, г. Санкт-Петербург, ул. Калинина, дом 2, корпус 4, литера А.