



MTCH6301 PROJECTED CAPACITIVE TOUCH CONTROLLER

MTCH6301 Projected Capacitive Touch Controller

Description

The MTCH6301 is a turnkey projected capacitive controller that allows easy integration of multi-touch and gestures to create a rich user interface in your design. Through a sophisticated combination of Self and Mutual Capacitive scanning for both XY screens and touch pads, the MTCH6301 allows designers to quickly and easily integrate projected capacitive touch into their application.

Applications:

- Human-machine interfaces with configurable button, keypad or scrolling functions
- Single-finger gesture based interfaces to swipe, scroll, or doubletap controls
- Home automation control panels
- Security control keypads
- Automotive center stack controls
- Gaming devices
- Remote control touch pads

Touch Sensor Support

- Up to 13RX x 18TX channels
- Works with printed circuit board (PCB), film, glass, and flexible circuit board (FPC) sensors
- Supports sensor sizes up to 4.3"
- Individual channel tuning for optimal sensitivity
- Cover layer support:
 - Plastic: up to 3 mm
 - Glass: up to 5 mm

Touch Performance

- >100 reports per second single touch
- >60 reports per second dual touch
- Up to 12-bit resolution coordinate reporting

Touch Features

- Multitouch (up to 10 touches)
- Gesture detection and reporting
- Single and dual touch drawing
- Self and Mutual signal acquisition
- Built-in noise detection and filtering

Power Management

- Configurable Sleep mode
- Integrated Power-on Reset and Brown-out Reset
- 20 μ A sleep current (typical)

Communication Interface

- I²C™ (up to 400 kbps)

Operating Conditions

- 2.4V to 3.6V, -40°C to +105°C

Package Types

- 44-Lead TQFP
- 44-Lead QFN

MTCH6301 PROJECTED CAPACITIVE TOUCH CONTROLLER

Table of Contents

1.0	System Block Diagram	3
2.0	Configuration and Setup.....	3
3.0	Pin Diagram.....	4
4.0	Layout.....	6
5.0	Communication Protocol	10
6.0	Memory Map	16
7.0	Special Features	18
8.0	Electrical Characteristics	21
9.0	Ordering Information	24
10.0	Packaging Information.....	25

TO OUR VALUED CUSTOMERS

It is our intention to provide our valued customers with the best documentation possible to ensure successful use of your Microchip products. To this end, we will continue to improve our publications to better suit your needs. Our publications will be refined and enhanced as new volumes and updates are introduced.

If you have any questions or comments regarding this publication, please contact the Marketing Communications Department via E-mail at docerrors@microchip.com or fax the **Reader Response Form** in the back of this data sheet to (480) 792-4150. We welcome your feedback.

Most Current Data Sheet

To obtain the most up-to-date version of this data sheet, please register at our Worldwide Web site at:

<http://www.microchip.com>

You can determine the version of a data sheet by examining its literature number found on the bottom outside corner of any page. The last character of the literature number is the version number, (e.g., DS30000A is version A of document DS30000).

Errata

An errata sheet, describing minor operational differences from the data sheet and recommended workarounds, may exist for current devices. As device/documentation issues become known to us, we will publish an errata sheet. The errata will specify the revision of silicon and revision of document to which it applies.

To determine if an errata sheet exists for a particular device, please check with one of the following:

- Microchip's Worldwide Web site; <http://www.microchip.com>
- Your local Microchip sales office (see last page)

When contacting a sales office, please specify which device, revision of silicon and data sheet (include literature number) you are using.

Customer Notification System

Register on our web site at www.microchip.com to receive the most current information on all of our products.

MTCH6301 PROJECTED CAPACITIVE TOUCH CONTROLLER

1.0 SYSTEM BLOCK DIAGRAM

The MTCH6301 is a turnkey projected capacitive touch controller that allows easy integration of multitouch and gestures to create a rich user interface in your design. Through a sophisticated combination of Self and Mutual Capacitive scanning for both XY screens and touch pads, the MTCH6301 allows designers to quickly and easily integrate projected capacitive touch into their application.

The Projected Capacitive Configuration Utility with an autotune feature allows fast customization for different sizes and top layer thicknesses.

For further customization, designers can also get access to the firmware library to optimize and improve designs as needed.

FIGURE 1-1: BLOCK DIAGRAM

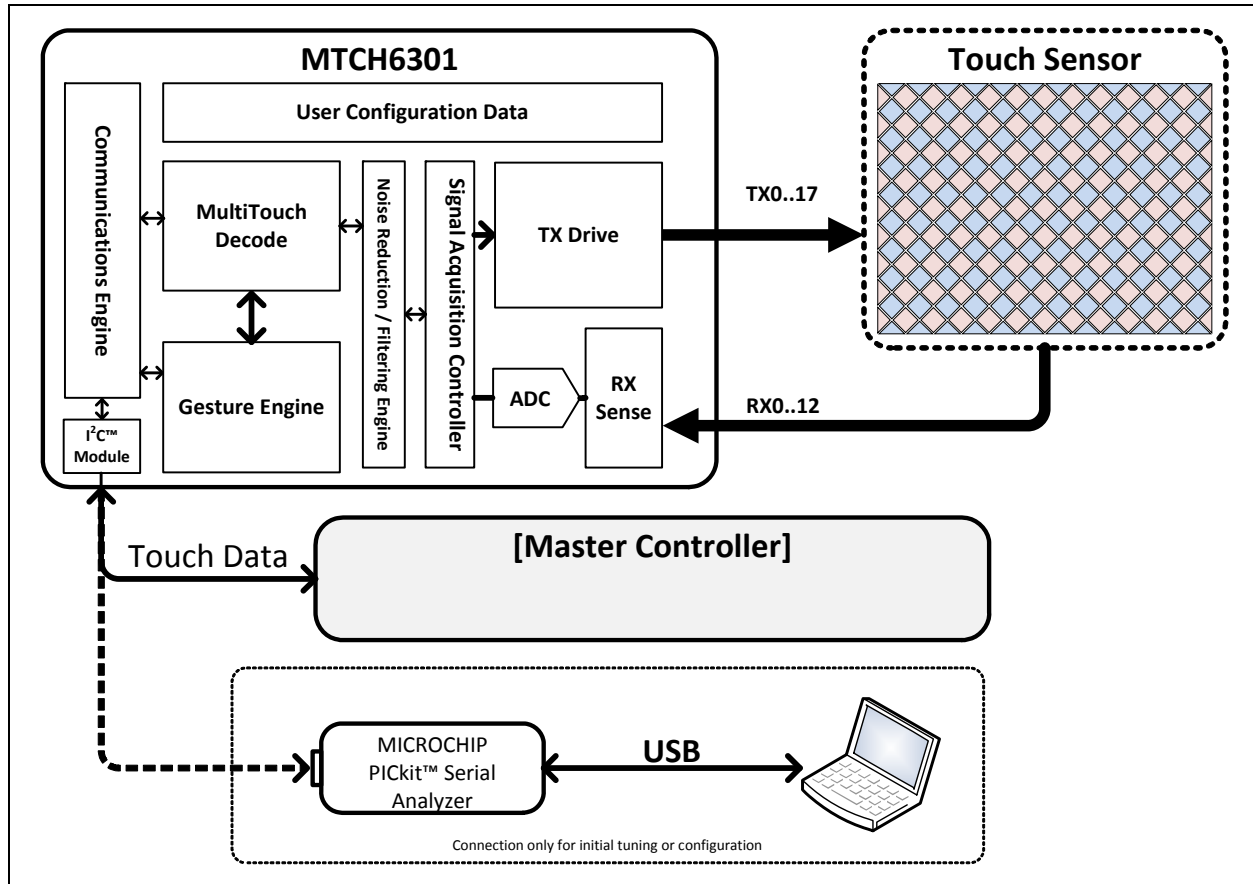

2.0 CONFIGURATION AND SETUP

The MTCH6301 is pre-configured for a 12 Receiver (RX)/9 Transmitter (TX) touch sensor, mapped as shown in [Section 4.0 "Layout"](#). While the device will work out of the box using this specific sensor configuration, most applications will require additional configuration and sensor tuning to determine the correct set of parameters to be used in the final application.

Microchip provides a PC-based configuration tool for this purpose, available in the mTouch™ Sensing Solution Design Center (www.microchip.com/mtouch). Use of this tool requires a PICkit™ Serial Analyzer (updated with MTCH6301 support), as well as access to the I²C communications bus of the MTCH6301.

Once the development process is complete, these modified parameters must either be written permanently to the controller (via NVRAM, refer to [Section 7.3 "Non-Volatile RAM \(NVRAM\)"](#)), or alternatively can be sent every time the system is powered on. Either the PICkit Serial Analyzer or the Master I²C Controller can be used for this purpose.

MTCH6301 PROJECTED CAPACITIVE TOUCH CONTROLLER

3.0 PIN DIAGRAM

FIGURE 3-1: PIN DIAGRAM

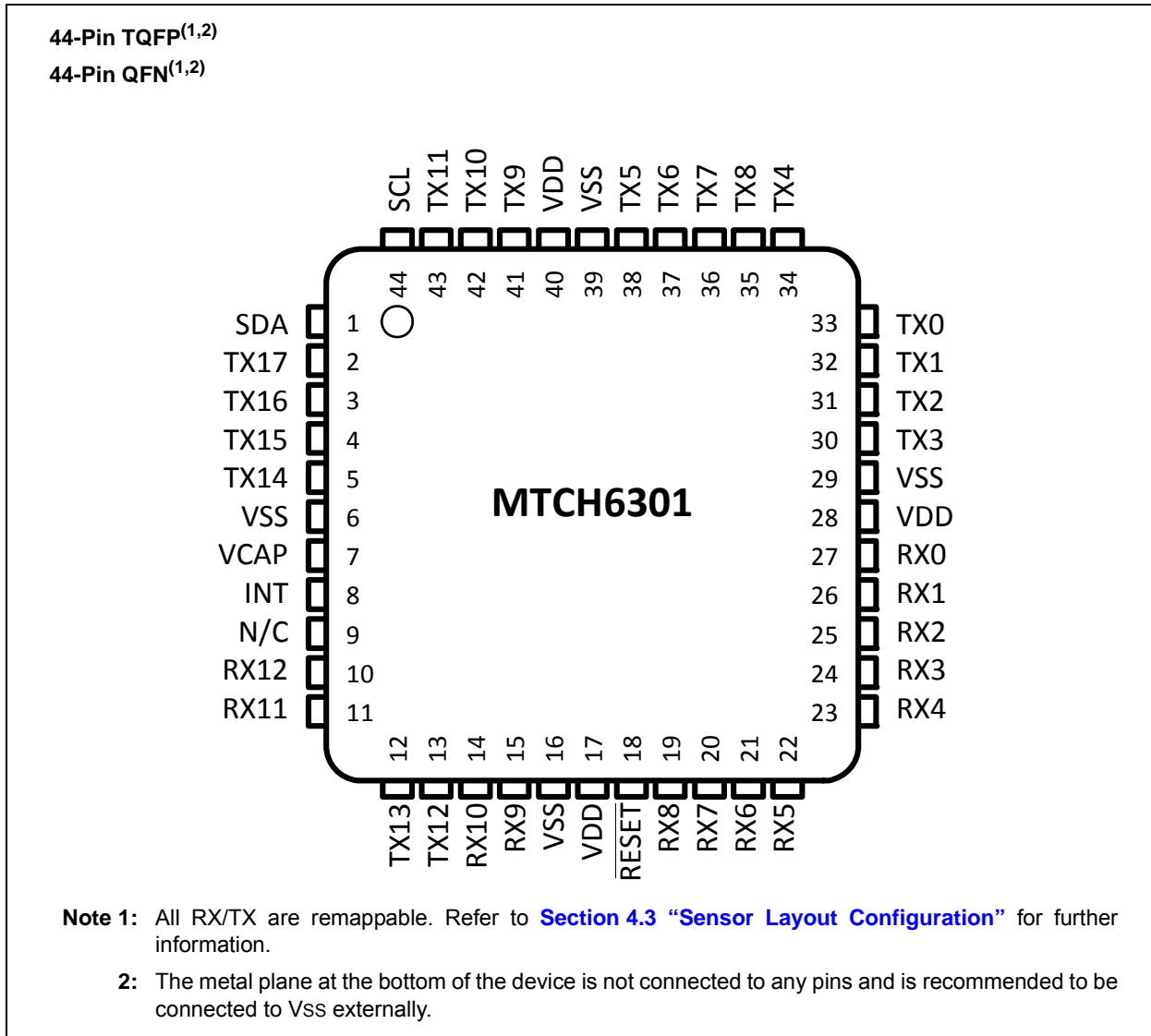

MTCH6301 PROJECTED CAPACITIVE TOUCH CONTROLLER

TABLE 3-1: PINOUT I/O DESCRIPTIONS

Pin Name	Pin Number	Pin Type	Description
RESET	18	I/P	Reset device (active low)
SCL	44	I	Synchronous serial clock input/output for I ² C™
SDA	1	I/O	Synchronous serial data input/output for I ² C
INT	8	O	Interrupt (from MTCH6301 to master) for I ² C
RX0	27	I/O	RX Sense (or TX Drive)
RX1	26	I/O	
RX2	25	I/O	
RX3	24	I/O	
RX4	23	I/O	
RX5	22	I/O	
RX6	21	I/O	
RX7	20	I/O	
RX8	19	I/O	
RX9	15	I/O	
RX10	14	I/O	
RX11	11	I/O	
RX12	10	I/O	
TX0	33	O	TX Drive
TX1	32	O	
TX2	31	O	
TX3	30	O	
TX4	34	O	
TX5	38	O	
TX6	37	O	
TX7	36	O	
TX8	35	O	
TX9	41	O	
TX10	42	O	
TX11	43	O	
TX12	13	O	
TX13	12	O	
TX14	5	O	
TX15	4	O	
TX16	3	O	
TX17	2	O	
N/C	9	N/C	No Connect
VCAP	7	P	CPU logic filter capacitor connection
VDD	17, 28, 40	P	Positive supply for peripheral logic and I/O pins
VSS	6, 16, 29, 39	P	Ground reference for logic and I/O pins. This pin must be connected at all times

MTCH6301 PROJECTED CAPACITIVE TOUCH CONTROLLER

4.0 LAYOUT

4.1 Typical Application Circuit

The following schematic portrays a typical application circuit, based on a 12RX/9TX touch sensor.

FIGURE 4-1: TYPICAL APPLICATION CIRCUIT

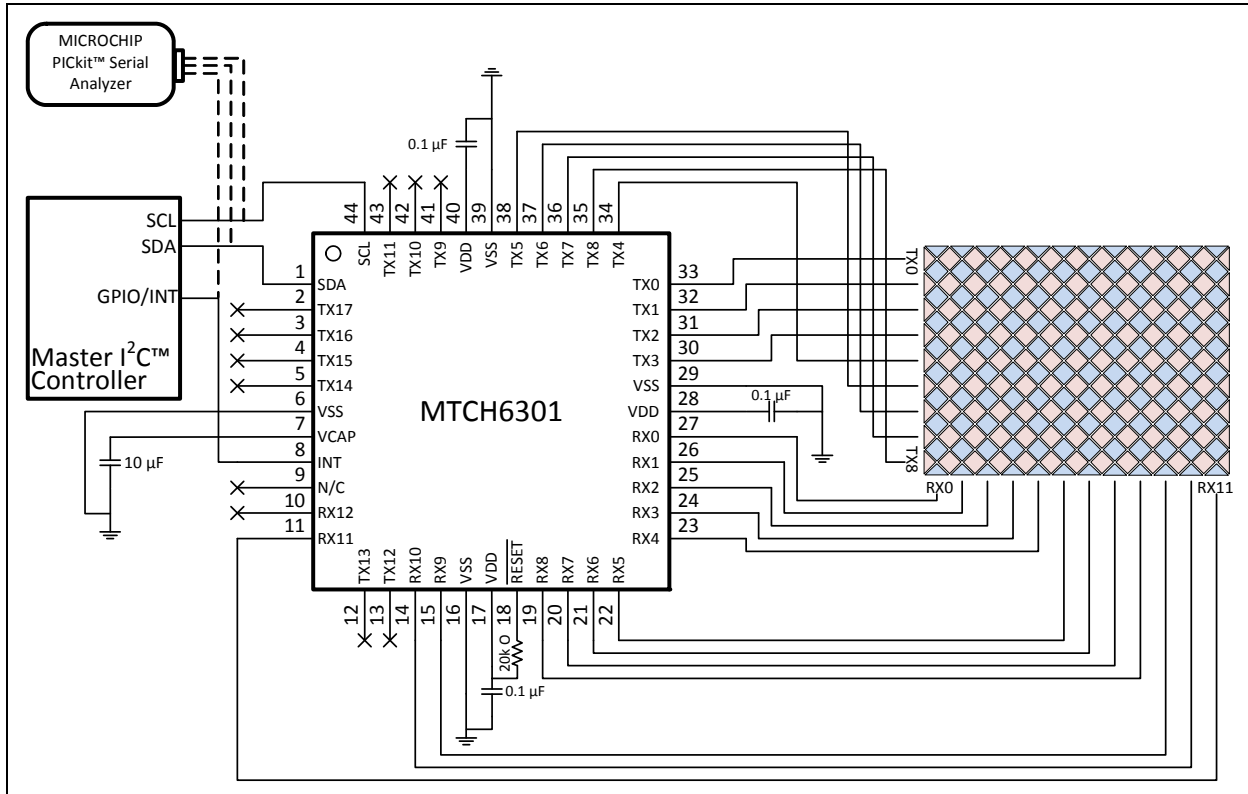

4.2 Touch Sensor Design

Please refer to the mTouch Sensing Solution design center at www.microchip.com/mtouch for additional information regarding design and layout of touch sensors.

4.3 Sensor Layout Configuration

To properly configure a sensor from a physical layout standpoint, the following registers must be correctly configured:

- RX Pin Map/TX Pin Map
- RX Scaling Coefficient/TX Scaling Coefficient
- Flip State

4.3.1 RX/TX PIN MAP

By default, the RX and TX pins are set as shown in the Typical Application Circuit (Figure 4.1). If you require a different layout or a different amount of sensor channels, the RX and TX pins are configured via pin map arrays. To access these arrays, reference [Section 5.0 “Communication Protocol”](#) and [Section 6.0 “Memory Map”](#) of this document.

The RX and TX lines are configurable for the purpose of making trace routing and board layout more convenient. Please note that while RX pins can be used as TX pins instead, a single pin cannot be used as BOTH an RX and a TX channel concurrently. The pin maps are comprised of “Pin Map ID” numbers, which are shown in [Table 4-1](#).

MTCH6301 PROJECTED CAPACITIVE TOUCH CONTROLLER

TABLE 4-1: PIN MAP ID CHART

Pin	Map ID (TX)	Map ID (RX)
RX0	27	8
RX1	26	7
RX2	25	6
RX3	12	5
RX4	11	4
RX5	10	3
RX6	9	2
RX7	1	1
RX8	0	0
RX9	24	9
RX10	23	10
RX11	22	11
RX12	21	12
TX0	13	—
TX1	6	—
TX2	3	—
TX3	2	—
TX4	4	—
TX5	7	—
TX6	28	—
TX7	29	—
TX8	30	—
TX9	14	—
TX10	15	—
TX11	16	—
TX12	5	—
TX13	8	—
TX14	34	—
TX15	33	—
TX16	32	—
TX17	31	—

Note: Trace routing for sensors requires proper design technique. Please refer to the mTouch Sensing Solution design center at www.microchip.com/mtouch for additional information on correctly routing touch sensor traces.

4.3.2 UNUSED RX/TX PINS

Unused RX/TX pins are driven to Vss automatically, and should be left as no connects.

4.3.3 RX/TX SCALING COEFFICIENTS

Scaling coefficient registers exist in RAM for each axis (RX/TX) and must be modified in accordance with the number of channels that are in use. Special attention must be paid to sensor dimensions that have fewer than 5 channels, which will have a smaller maximum touch output value (coordinate).

The relationship between these constant, as well as the maximum coordinates that will be transmitted are displayed in [Table 4-2](#).

TABLE 4-2: RX/TX SCALING COEFFICIENTS

Number of Channels	RX/TX Scaling Coefficient	Controller Output Range
3	65535	[0-2047]
4		[0-3071]
5		[0-4095]
6	52429	
7	43691	
8	37449	
9	32768	
10	29127	
11	26214	
12	23831	
13	21845	
14	20165	
15	18725	
16	17476	
17	16384	
18	15420	

4.3.4 SENSOR ORIENTATION

The final output orientation is configured via the FLIPSTATE register. This register can be adjusted during operation for applications where rotation occurs during use.

[Figure 4-2](#) shows the initial upright orientation FLIPSTATE register values for all possible sensor layouts.

MTCH6301 PROJECTED CAPACITIVE TOUCH CONTROLLER

REGISTER 4-1: FLIPSTATE REGISTER

U-0	U-0	U-0	U-0	U-0	R/W-0	R/W-0	R/W-1
—	—	—	—	—	SWAP	TXFLIP	RXFLIP
bit 7							bit 0

Legend:

R = Readable bit W = Writable bit U = Unimplemented bit, read as '0'
 -n = Value at POR '1' = Bit is set '0' = Bit is cleared x = Bit is unknown

- bit 7-3 **Unimplemented: Read as '0'**
- bit 2 **SWAP**
 1 = RX axis horizontal; TX axis vertical
 0 = RX axis vertical; TX axis horizontal
- bit 1 **TXFLIP**
 1 = Invert the TX axis
 0 = Do not invert the TX axis
- bit 0 **RXFLIP**
 1 = Invert the RX axis
 0 = Do not invert the RX axis

FIGURE 4-2: SENSOR ORIENTATION CHART

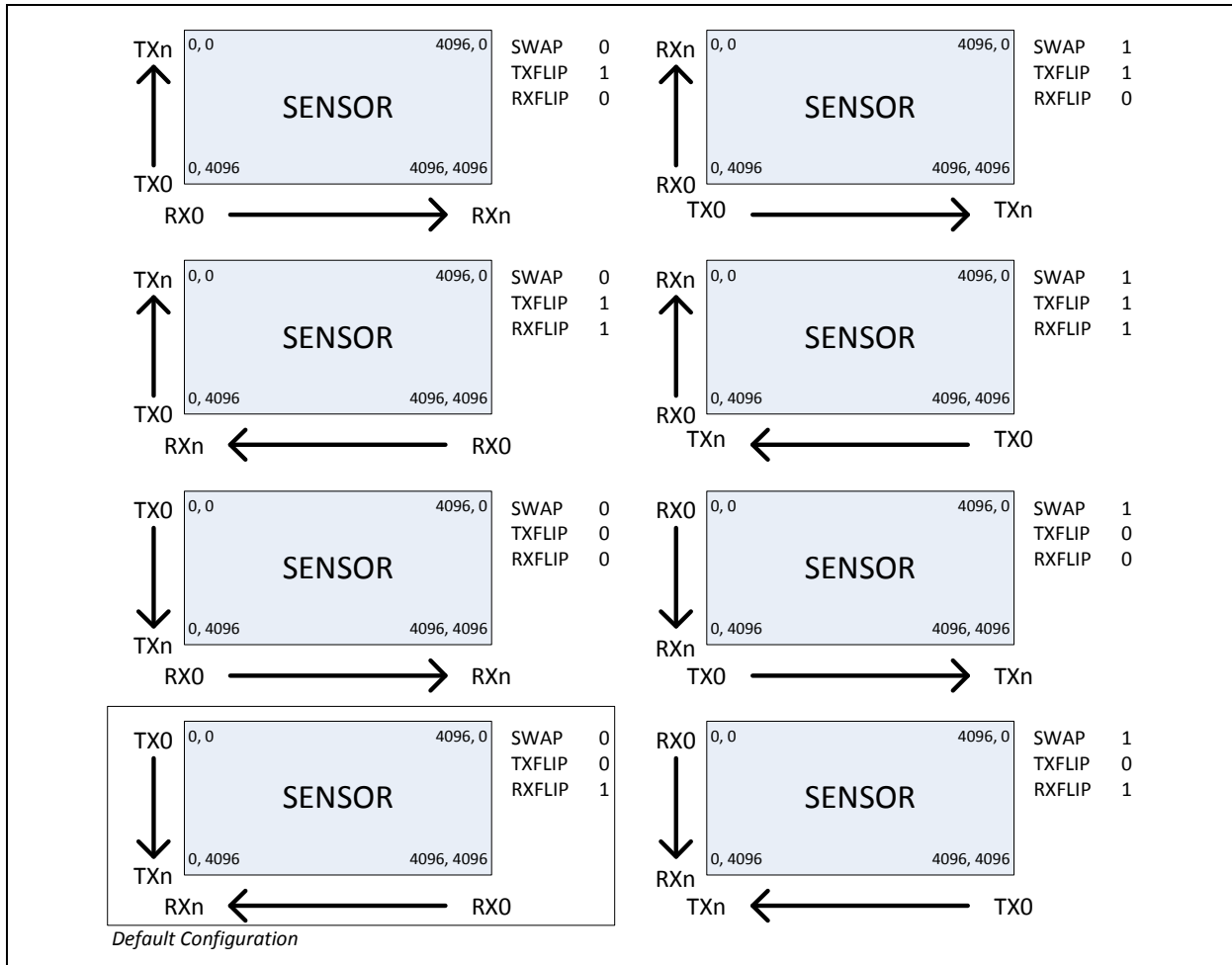

MTCH6301 PROJECTED CAPACITIVE TOUCH CONTROLLER

4.4 Example Custom Application Layout

An example 4-channel RX/11-channel TX sensor is shown in Figure 4-3. In addition to using a completely modified pin layout, this example differs from the default configuration by also having the TX axis along the bottom (X) and RX axis along the side (Y). Note that some RX pins are used as TX lines in this example.

FIGURE 4-3: NON-STANDARD LAYOUT EXAMPLE

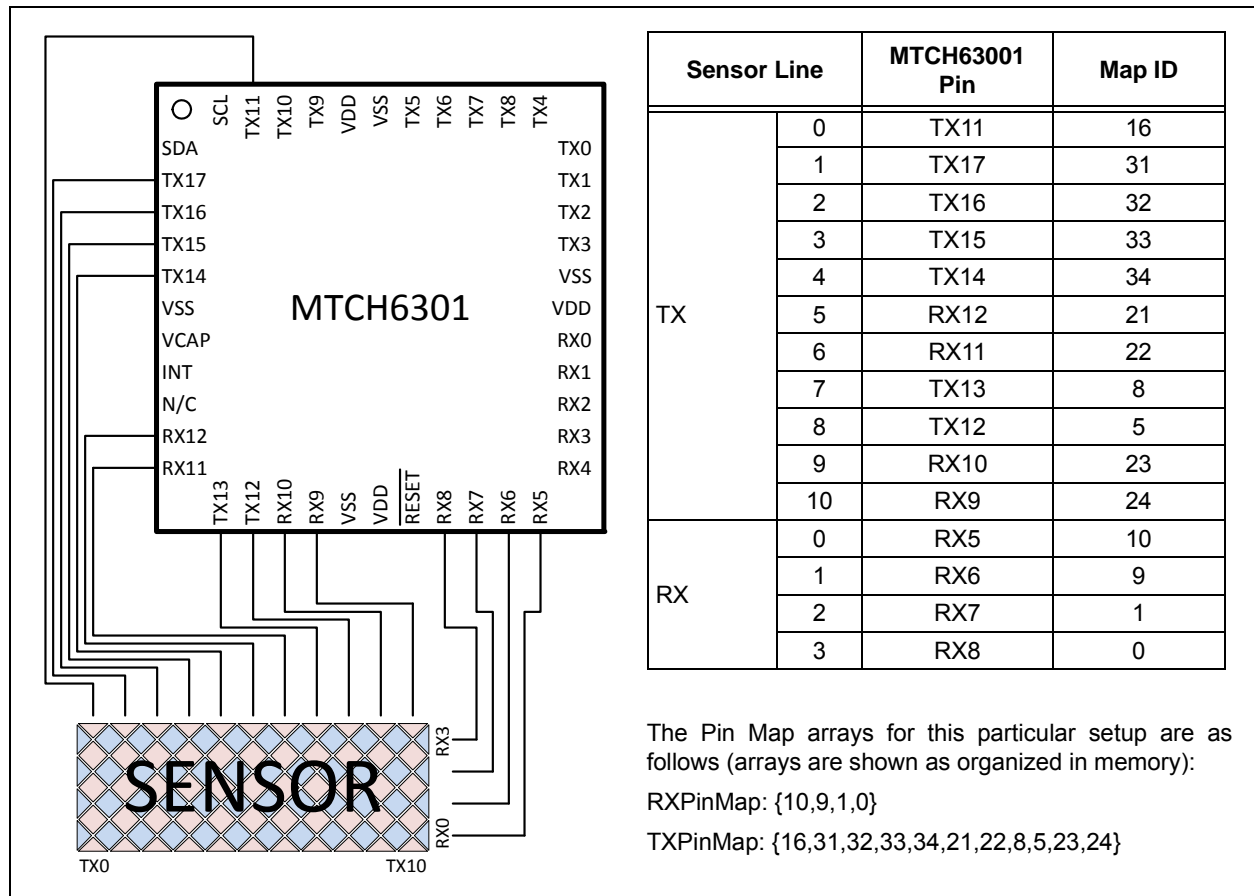

Using the scaling coefficient table generates the values displayed in Table 4-3.

TABLE 4-3: CUSTOM APPLICATION SCALING COEFFICIENTS

Axis	Channels	Scaling Coefficient	Maximum Output
RX	4	65535	[0-3071]
TX	11	26214	[0-4095]

The FLIPSTATE register, using Figure 4-2, should be set to 0b111, or 0x7, for this particular example.

MTCH6301 PROJECTED CAPACITIVE TOUCH CONTROLLER

5.0 COMMUNICATION PROTOCOL

5.1 Overview

The MTCH6301 has two basic communication types: Touch & Gesture Protocol, and Command Protocol.

Touch & Gesture Protocol

Fully processed touch coordinates and gestures will be transmitted immediately as they are processed by the MTCH6301. Since it is a slave device, the INT pin will be asserted whenever one of these packets is ready for transmission. This requires the master controller to initiate a READ command to receive the touch or gesture packet.

Command Protocol

All other commands are invoked by the I²C master controller. Commands are used for configuring and controlling the device.

Master Read Details

Please note that any read from the controller by the master, including both touch & gesture protocol and command protocol, will be prefixed by a single byte. This single byte denotes the number of bytes that are to be transferred. This byte is NOT represented in the tables and figures for the protocol, but is detailed in [Figure 5-6](#) and [Figure 5-7](#).

5.2 Touch Protocol

The packet in [Table 5-1](#) is transmitted for each touch that is present on the sensor.

TABLE 5-1: TOUCH PROTOCOL

Packet	Bit 7	Bit 6	Bit 5	Bit 4	Bit 3	Bit 2	Bit 1	Bit 0
0	1	TOUCHID<3:0>				TCH(0)	0	PEN
1	0	X<6:0>						
2	0	0	0	X<11:7>				
3	0	Y<6:0>						
4	0	0	0	Y<11:7>				

Legend: TOUCHID: Touch ID (0-9)
PEN: Pen State
0 = Pen Up
1 = Pen Down
X: X Coordinate of Touch
Y: Y Coordinate of Touch
TCH: Always 0, denotes a touch packet

5.3 Gesture Protocol

The packet in [Table 5-2](#) is transmitted whenever a gesture is performed on the sensor. This feature can be enabled via the Gesture Protocol register ([Table 5-2](#)). Gestures are NOT enabled by default.

Note: For any “hold” gestures, packets are sent continuously until the gesture (touch) is released.

MTCH6301 PROJECTED CAPACITIVE TOUCH CONTROLLER

TABLE 5-2: GESTURE PROTOCOL

Packet	Bit 7	Bit 6	Bit 5	Bit 4	Bit 3	Bit 2	Bit 1	Bit 0
0	1	TOUCHID<3:0>				GEST(1)	0	0
1	0	GESTURE<6:0>						

Legend:

TOUCHID: Touch ID (0-7)

GESTURE: Gesture ID

- 0x10 Single Tap
- 0x11 Single Tap (hold)
- 0x20 Double Tap
- 0x31 Up Swipe
- 0x32 Up Swipe (hold)
- 0x41 Right Swipe
- 0x42 Right Swipe (hold)
- 0x51 Down Swipe
- 0x52 Down Swipe (hold)
- 0x61 Left Swipe
- 0x62 Left Swipe (hold)

GEST: Always 1, denotes a gesture packet

5.4 Example Touch Data

Figure 5-1 depicts multitouch transmission in one touch activation that is already in progress (ID0), and a second activation (ID1) being removed from the sensor.

The first activation also completes a gesture. The I²C prefix bytes are not shown in this example.

FIGURE 5-1: EXAMPLE TOUCH DATA

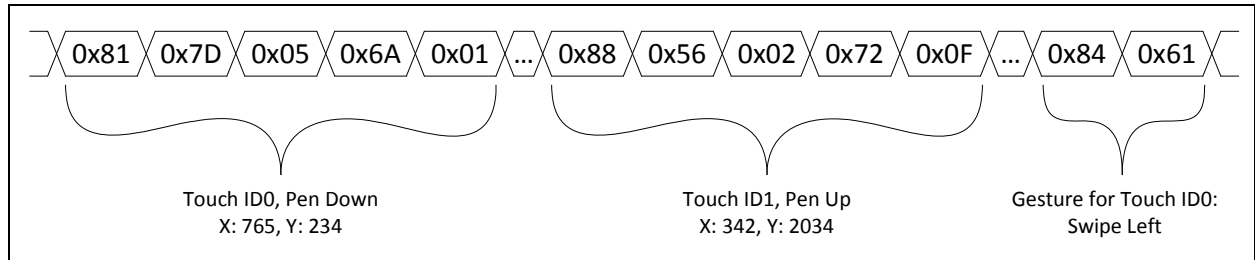

MTCH6301 PROJECTED CAPACITIVE TOUCH CONTROLLER

5.5 Command Protocol

Figure 5-2 depicts bidirectional communication protocol (for reading/writing configuration data).

FIGURE 5-2: COMMAND PROTOCOL

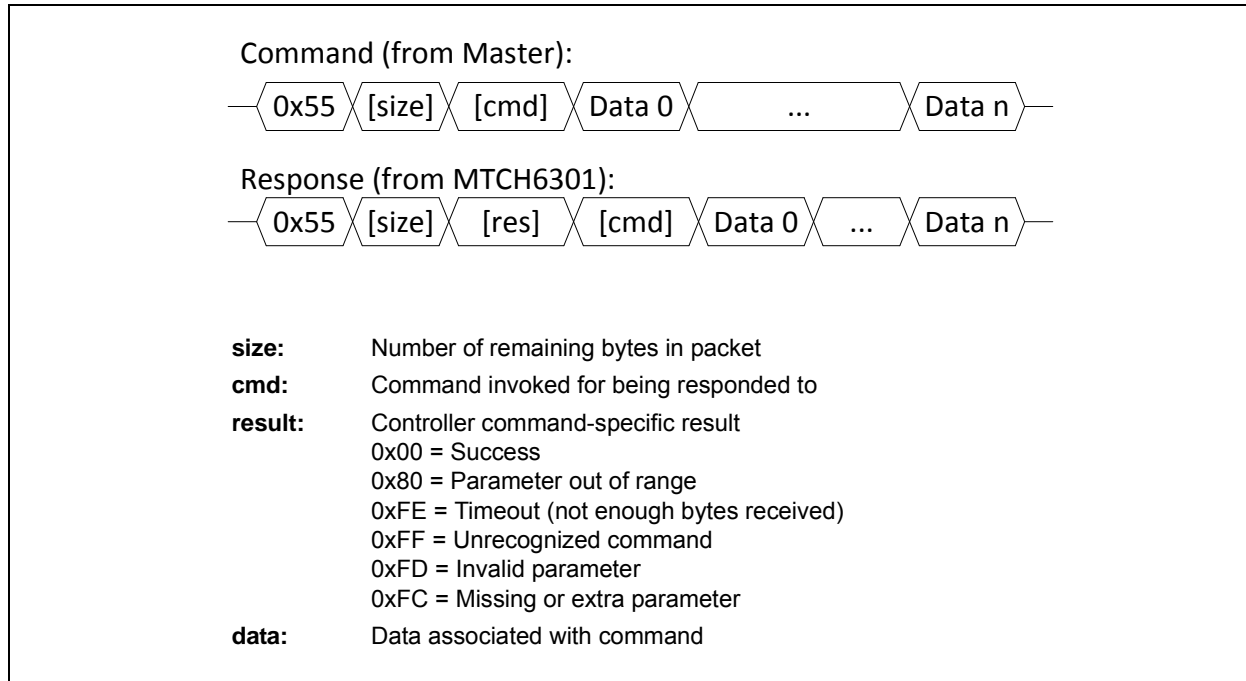

5.6 Full Command Set

A complete listing of MTCH6301 commands is shown in Table 5-3. Any commands which contain data bytes, either sent or received, are shown alongside an example stream of data in the following sections.

TABLE 5-3: COMMAND SET

ID	Name	Description
0x00	Enable Touch	Enable touch functionality
0x01	Disable Touch	Disable touch functionality
0x14	Scan Baseline	Instruct controller to scan for a new sensor baseline
0x15	Write Register	Write data to a specific register
0x16	Read Register	Read data from a specific register
0x17	Write NVRAM	Write all current register values to NVRAM
0x18	Software Sleep	Instructs the controller to enter sleep mode
0x19	Erase NVRAM	Erase the contents of the non-volatile RAM section.
0x1A	Manufacturing Test	Perform manufacturing tests on all sensor I/O channels

5.6.1 WRITE REGISTER/READ REGISTER

Writes or reads a single register. Note that all registers are volatile, and any modified data will be lost on power down. Registers must be saved to NVRAM to store the configuration permanently

MTCH6301 PROJECTED CAPACITIVE TOUCH CONTROLLER

FIGURE 5-3: WRITE REGISTER COMMAND

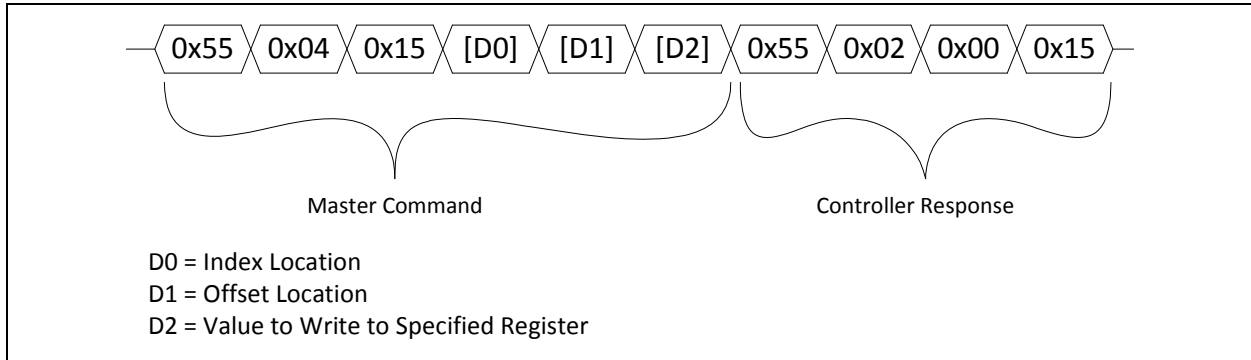
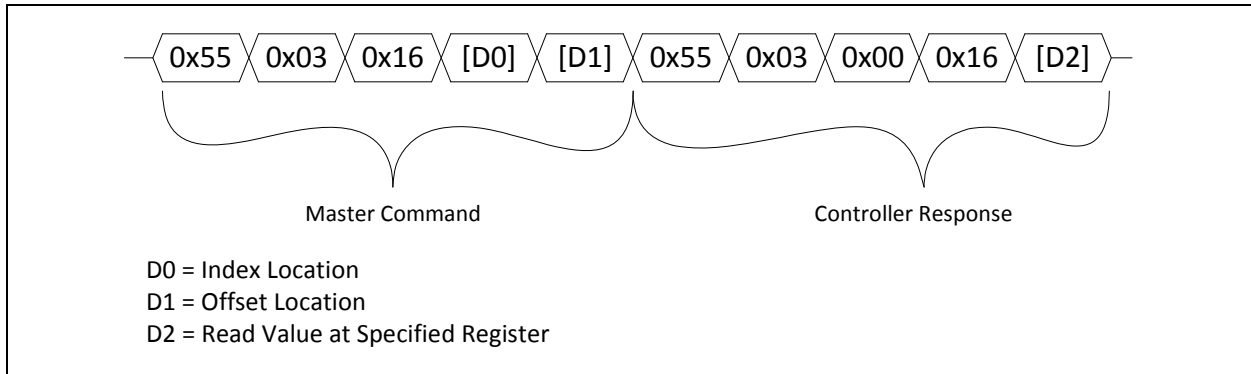

FIGURE 5-4: READ REGISTER COMMAND



5.6.2 MANUFACTURING TEST

The manufacturing test ensures electrical functionality of the sensor. This test performs the following checks on all mapped sensor pins: short to VDD, Short to GND, and pin-to-pin short.

If an I/O error is reported, bits for the pins in question will be set in the “TX Short Status” and “RX Short Status” registers.

Please note that:

1. The RX7/RX8 pins will always report an error.
2. If the sensor has more than 16 TX channels, then channels 17 and 18 will never report an error.

FIGURE 5-5: MANUFACTURING TEST

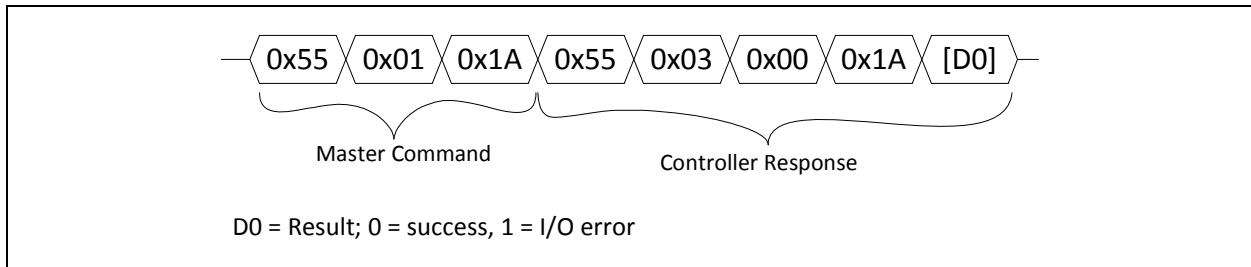

MTCH6301 PROJECTED CAPACITIVE TOUCH CONTROLLER

5.7 I²C Specification

The MTCH6301 device supports the I²C serial protocol, with the addition of an interrupt pin for notifying the master that data is ready. The device operates in Slave mode, meaning that the device does not generate the serial clock.

5.7.1 SERIAL DATA (SDA)

The Serial Data (SDA) signal is the data signal of the device. The value on this pin is latched on the rising edge of the SCL signal when the signal is an input. With the exception of the START (RESTART) and STOP conditions, the high or low state of the SDA pin can only change when the clock signal on the SCL pin is low. During the high period of the clock, the SDA pin's value (high or low) must be stable. Changes in the SDA pin's value while the SCL pin is HIGH will be interpreted as a START or a STOP condition.

5.7.2 SERIAL CLOCK (SCL)

The Serial Clock (SCL) signal is the clock signal of the device. The rising edge of the SCL signal latches the value on the SDA pin. The MTCH6301 employs clock

stretching, and this should be taken into account by the master controller. The maximum speed at which the MTCH6301 can operate is 400 kbps.

5.7.3 INTERRUPT (INT)

This pin is utilized by the MTCH6301 to signal that data is available, and that the master controller should invoke a MASTER READ. INT is an active high pin, and is held low during all other activities.

Note: If the device is not read within 25 ms of asserting the INT pin, it will time out and data will no longer be available.

5.7.4 DEVICE ADDRESSING

The MTCH6301 7-bit base address is set to 0x25, and is not configurable by the user. Every transmission must be prefixed with this address, as well as a bit signifying whether the transmission is a MASTER WRITE ('0') or MASTER READ ('1'). After appending this read/write bit to the base address, this first byte becomes either 0x4A (WRITE) or 0x4B (READ).

FIGURE 5-6: SINGLE TRANSMISSION I²C™ FORMAT

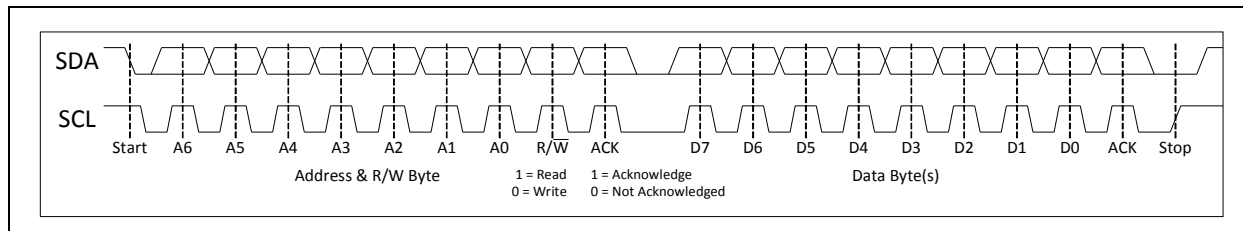

5.7.5 TYPICAL I²C™ COMMAND READ AND WRITE

Figure 5-7 depicts the master controller reading from RAM location 0x01 (number of RX channels), and the device responding accordingly with 0x0C (Figure 5-6).

MTCH6301 PROJECTED CAPACITIVE TOUCH CONTROLLER

FIGURE 5-7: I²C™ COMMAND READ AND WRITE

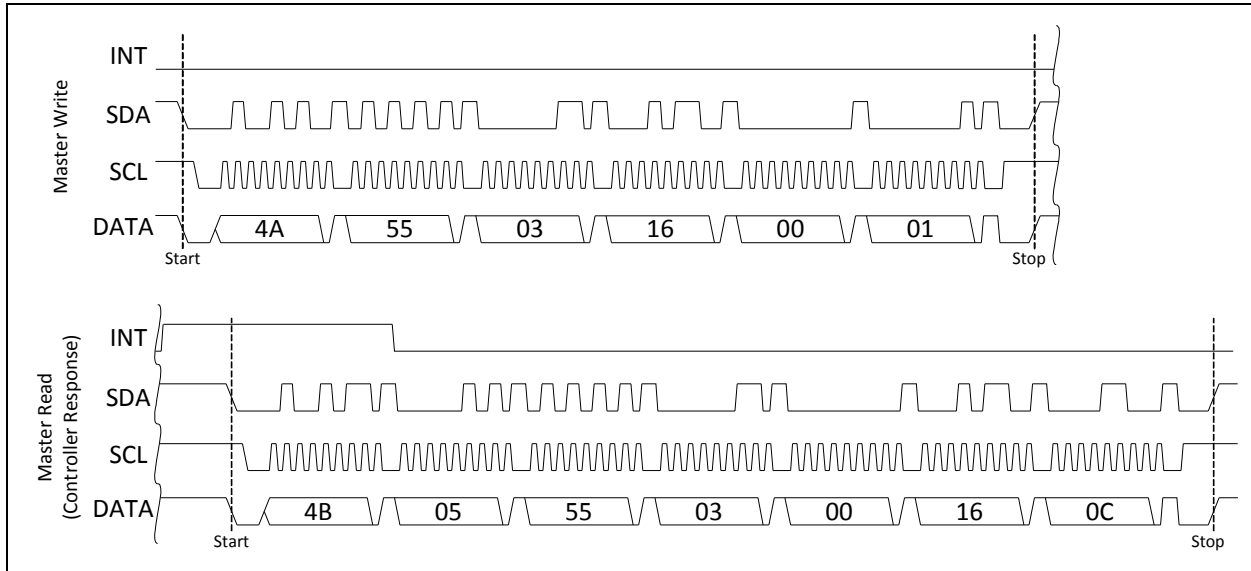

5.7.6 TYPICAL I²C TOUCH PACKET READ

Figure 5-8 depicts a single touch packet being streamed from the controller. In this case, touch ID 0 at location (1940,2592).

FIGURE 5-8: I²C™ TOUCH PACKET READ

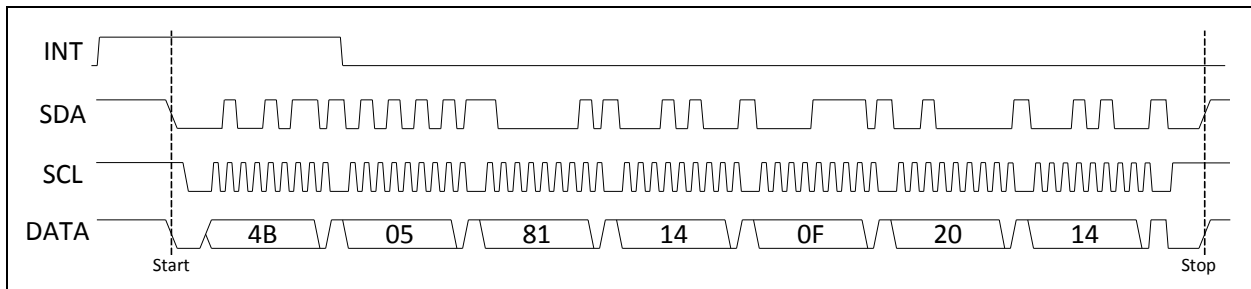

5.7.7 WAKE ON I²C

The MTCH6301 is capable of waking up upon receiving an I²C command from the host. Note that since wake-up time can take up to 350 μ s, the controller must resend any I²C bytes that were not acknowledged (ACK) before continuing the transmission.

Since the controller will wake up upon a correct I²C address match, it does not matter which command is sent. For simplicity, the Enable Touch command is recommended.

MTCH6301 PROJECTED CAPACITIVE TOUCH CONTROLLER

6.0 MEMORY MAP

TABLE 6-1: MTCH6301 MEMORY MAP

	Index Byte	Offset Byte	Register Name	Size Bytes	Description	Data Range	Default Value
General	0x00	0x01	RX Channels	1	Number of RX Sensor Channels	3-13	12
		0x02	TX Channels	1	Number of TX Sensor Channels	3-18	9
		0x04	RX Scaling [7:0]	2	RX Scaling Coefficient	15420-65535	23831
		0x05	RX Scaling [15:8]				
		0x06	TX Scaling [7:0]	2	TX Scaling Coefficient	15420-65535	32768
		0x07	TX Scaling [15:8]				
Sensor Map	0x01	0x00-0x0C	RX Pin map	13	RX Pin Map Array	0-12	Note 1
	0x02	0x00-0x12	TX Pin map	18	TX Pin Map Array	0-34	Note 1
Self	0x10	0x00	Self Scan Time	1	Number of self readings to sum per electrode	1-30	5
		0x01	Self Threshold	1	Threshold for detecting a touch	10-150	50
Mutual	0x20	0x00	Mutual Scan Time	1	Number of mutual readings to sum per node	1-30	9
		0x01	Mutual Threshold	1	Threshold for detecting a touch	10-150	55
Decoding	0x30	0x00	FlipState	1	Determines orientation of sensor with respect to coordinate output	0b000-0b111	0b001
		0x01	Number of Averages	1	Smoothing Filter (number of previous coordinates to be averaged with current touch position)	1-16	8
		0x04	Minimum Touch Distance	1	Minimum distance allowed between touch locations – used for suppressing weak touches	0-255	150
		0x05	Pen Down Timer	1	Number of successive sensor scans needed to identify a touch prior to transmitting data	0-10	3
		0x06	Pen Up Timer	1	Number of successive sensor scans needed to identify released touch prior to transmitting data	0-10	3
		0x07	Touch Suppression Value	1	The maximum number of activations reported. 10 activations are tracked, but may not be reported. 0 = disable suppression feature	0-10	0

Note 1: RX Pin Map: {0x08 0x07 0x06 0x05 0x04 0x03 0x02 0x01 0x00 0x09 0x0A 0x0B 0x00}
TX Pin Map: {0x0D 0x06 0x03 0x02 0x04 0x07 0x1C 0x1D 0x1E 0x00 0x00 0x00 0x00 0x00 0x00 0x00 0x00}
Pin map array order reflects the physical sensor pin order, not the MTCH6301 pin sequence.

MTCH6301 PROJECTED CAPACITIVE TOUCH CONTROLLER

TABLE 6-1: MTCH6301 MEMORY MAP

	Index Byte	Offset Byte	Register Name	Size Bytes	Description	Data Range	Default Value
Gestures	0x50	0x00	RX Swipe Length	1	Minimum interpolated X-distance for 'swipe' gesture	10-255	160
		0x01	TX Swipe Length	1	Minimum interpolated Y-distance for 'swipe' gesture	10-255	150
		0x02	Swipe Boundary	1	Maximum interpolated distance in opposing direction to cancel 'swipe' gesture	0-255	150
		0x03	Swipe Hold Threshold	1	Maximum interpolated distance deviation allowed to determine 'held' swipe gesture	0-255	70
		0x04	Swipe Time [7:0]	2	Maximum time (ms) for 'swipe' gesture to be completed, beginning at initial touch-down	0-65535	200
		0x05	Swipe Time [15:8]				
		0x06	Tap Time [7:0]	2	Maximum time (ms) for 'tap' gesture, beginning at initial touch-down	0-65535	500
		0x07	Tap Time [15:8]				
		0x08	Tap Threshold	1	Maximum interpolated distance deviation allowed to determine 'tap' gesture	1-255	120
		0x09	Minimum Swipe Velocity	1	Minimum velocity to register the 'swipe' gesture. Events below this threshold will cancel the gesture (touch removed) or be re-evaluated for 'swipe-and-hold' (touch is held)	1-50	3
		0x0A	Double Tap Time [7:0]	2	Maximum time allowed between two taps to determine 'double tap' gesture	50-1000	350
		0x0B	Double Tap Time [15:8]				
		0x0C	Gesture Edge Keepout	1	Determines the width of 'keepout barrier' (inactive edge) of the perimeter of the sensor to reduce or eliminate issues due to edge effects	0-255	128
Configure	0xF0	0x00	SLP2 [7:0]	4	Time-out duration (ms) with no activations before controller enters Sleep mode	0-4,000,000,000	8000
		0x01	SLP2 [15:8]				
		0x02	SLP2 [23:16]				
		0x03	SLP2 [31:24]				
		0x05	SLP1	1	Interval to poll for touch while in Sleep mode	0-11	7
		0x07	Touch Packet CFG	1	Touch Packet Configuration	0x81 = Enabled 0x01 = Disabled	0x81
		0x09	Gesture Packet CFG	1	Gesture Packet Configuration	0x81 = Enabled 0x01 = Disabled	0x01
		0x0A	Status Packet CFG	1	Status Packet Configuration	0x81 = Enabled 0x01 = Disabled	0x01
I/O Status	0xF1	0x02	TX Short Status [7:0]	2	Identifies which TX pins are shorted after executing Manufacturing Test command – Read Only	0x00-0xFF	0x00
		0x03	TX Short Status [15:8]				
		0x06	RX Short Status [7:0]	2	Identifies which RX pins are shorted after executing Manufacturing Test command – Read Only	0x00-0xFF	0x00
		0x07	RX Short Status [15:8]				

Note 1: RX Pin Map: {0x08 0x07 0x06 0x05 0x04 0x03 0x02 0x01 0x00 0x09 0x0A 0x0B 0x00}
TX Pin Map: {0x0D 0x06 0x03 0x02 0x04 0x07 0x1C 0x1D 0x1E 0x00 0x00 0x00 0x00 0x00 0x00 0x00 0x00}
Pin map array order reflects the physical sensor pin order, not the MTCH6301 pin sequence.

MTCH6301 PROJECTED CAPACITIVE TOUCH CONTROLLER

7.0 SPECIAL FEATURES

7.1 Gestures

Single finger gestures are a fast and intuitive way to navigate a feature rich human-machine interface. The MTCH6301 supports 11 single finger gestures natively, without requiring interaction from the master processor.











Tuning may be required depending on the layout of the sensor, the time duration, and length of activation required for your gesture supported application. The most common defaults are already preloaded and

should serve most applications. These parameters and their descriptions are available in the “Gestures” section of the memory map ([Section 6.0 “Memory Map”](#)).

Note: Gestures are NOT enabled by default, and must be enabled via the gesture packet configuration byte in RAM (refer to [Section 6.0 “Memory Map”](#)).

If your application requires ONLY gesture functionality, and does not require touch coordinates, the touch packet configuration byte (refer to [Section 6.0 “Memory Map”](#)) can be used to turn off all touch coordinate data.

FIGURE 7-1: GESTURE TYPES

	Tap (Click)		Tap & Hold
	Double Tap (Double Click)		
	Swipe Down		Swipe Down and Hold
	Swipe Up		Swipe Up and Hold
	Swipe Right		Swipe Right and Hold
	Swipe Left		Swipe Left and Hold

7.2 Sleep

Sleep functionality is enabled by default, and follows the behavior detailed in [Figure 7-2](#). This functionality can be modified via the registers related to sleep.

SLP1: This delay controls how often the sensor is scanned for a touch while in Sleep mode. [Table 7-1](#) correlates the value of SLP1 to time (ms).

TABLE 7-1: SLP1 DELAY CHART

SLP1	Delay (ms)	SLP1	Delay (ms)
0	1	6	64
1	2	7 ⁽¹⁾	128 ⁽¹⁾
2	4	8	256
3	8	9	512
4	16	10	1024
5	32	11	2048

Note 1: Default setting.

SLP2: Time (ms) without touch activity before controller enters sleep mode.

FIGURE 7-2: SLEEP FUNCTIONALITY

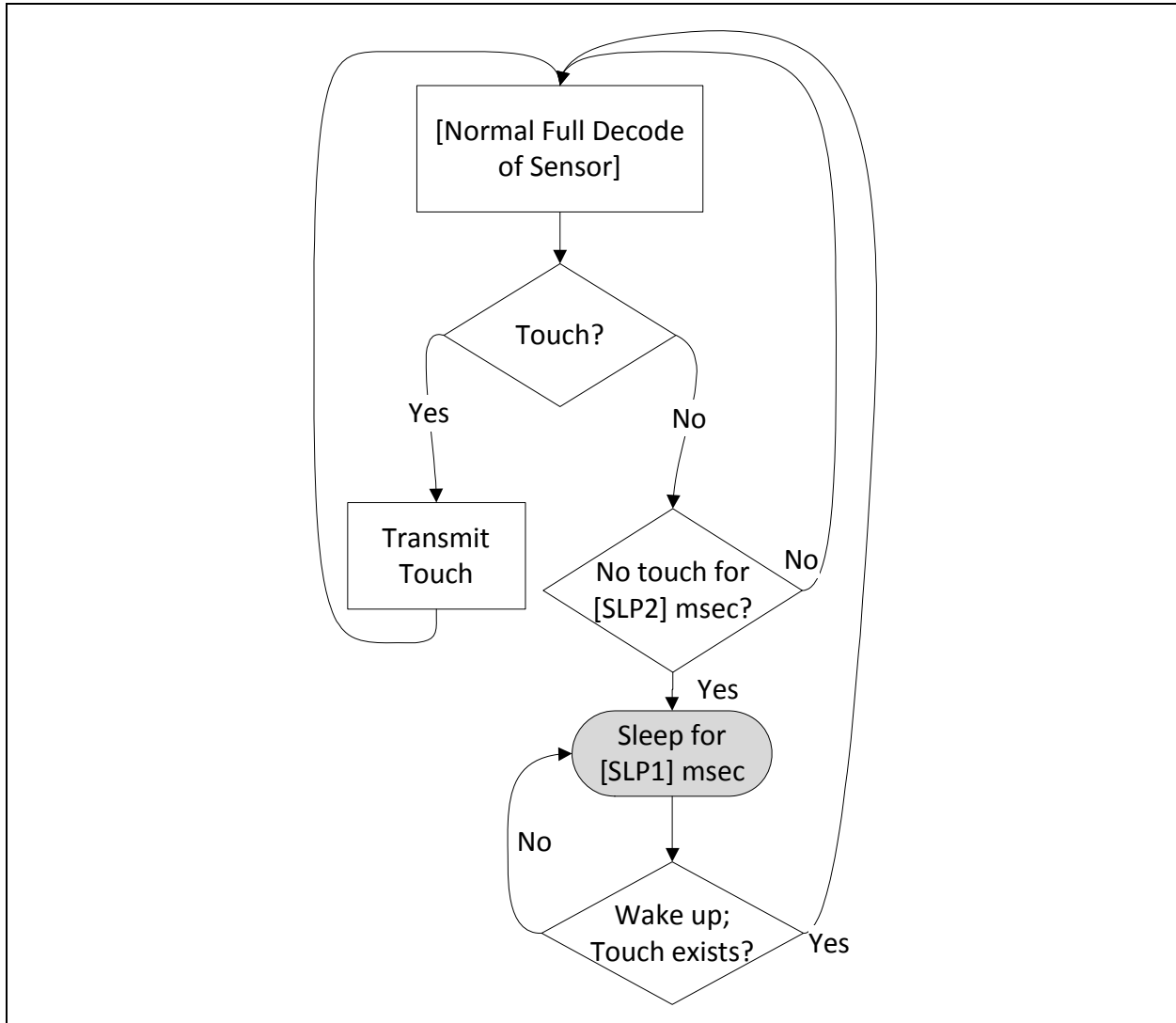

7.3 Non-Volatile RAM (NVRAM)

Permanent storage of parameters that have been modified can be achieved using the internal NVRAM. This NVRAM is not meant for continuous writing, as it has a low write cycle limit of 20,000.

Upon startup, the NVRAM's data (if present) is loaded into the controller. If no data is available in the NVRAM, the device defaults are loaded instead.

Please note that parameters cannot be written individually to the NVRAM. All registers will be written with one command. See the applicable command within the command set for more details. ([Section 5.6 "Full Command Set"](#))

7.4 Touch Performance

Using default acquisition parameters, [Figure 7-3](#) shows the relationship of single touch report rate with regard to sensor size.

Larger sensors will have a reduced report rate, due to the additional time needed to scan the sensor.

FIGURE 7-3: SINGLE-TOUCH REPORT RATE VS SENSOR SIZE

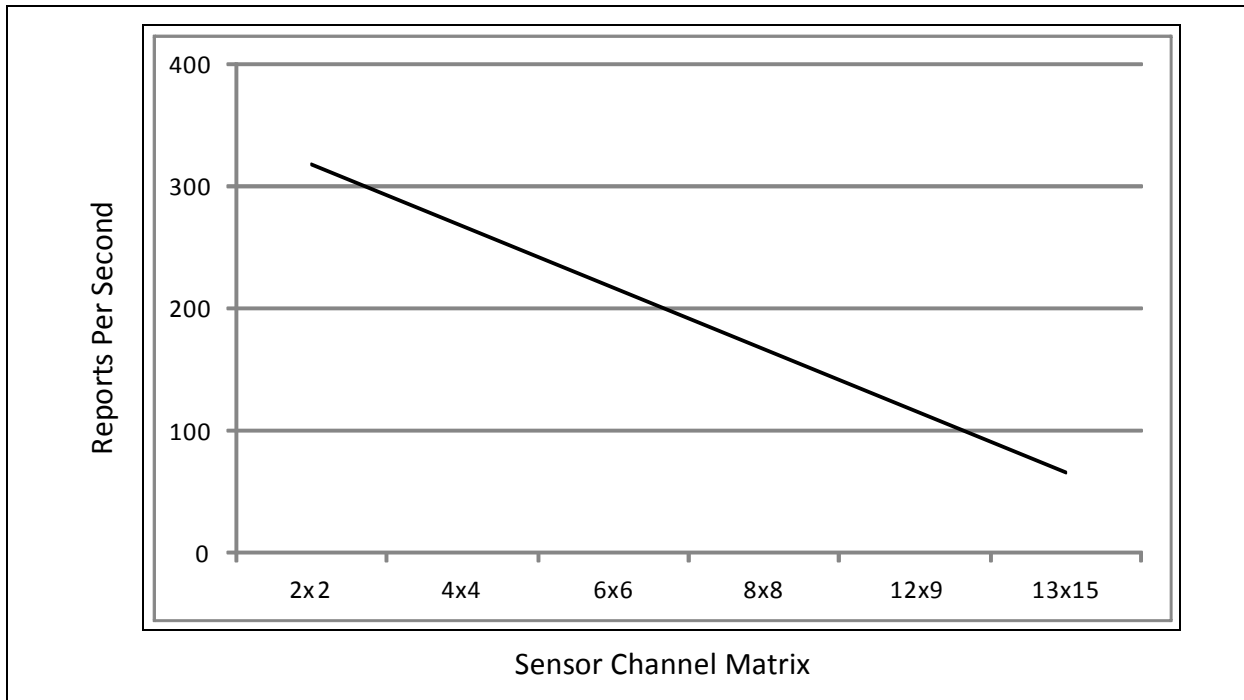

MTCH6301 PROJECTED CAPACITIVE TOUCH CONTROLLER

8.0 ELECTRICAL CHARACTERISTICS

This section provides an overview of the MTCH6301 electrical characteristics.

8.1 Absolute Maximum Ratings

Absolute maximum ratings for the MTCH6301 device are listed below. Exposure to these maximum rating conditions for extended periods may affect device reliability. Functional operation of the device at these or any other conditions, above the parameters indicated in the operation listings of this specification, is not implied.

Ambient temperature under bias	-40 to +85°C
Storage temperature.....	-65 to 150°C
Voltage on VDD with respect to VSS.....	-0.3V to 4.0V
Voltage on all other pins with respect to VSS.....	-0.3V to (VDD + 0.3V)
Maximum current out of VSS pin	300 mA
Maximum current into VDD pin(s)	300 mA
Maximum output current sunk by any I/O pin.....	15 mA
Maximum output current sourced by any I/O pin	15 mA
Maximum current sunk by all ports.	200 mA
Maximum current sourced by all ports.	200 mA

Stresses above those listed under “Absolute Maximum Ratings” may cause permanent damage to the device. This is a stress rating only and functional operation of the device at those or any other conditions, above those indicated in the operation listings of this specification, is not implied. Exposure to maximum rating conditions for extended periods may affect device reliability.

8.2 DC Characteristics

TABLE 8-1: THERMAL OPERATING CONDITIONS

Rating	Symbol	Min.	Typ.	Max.	Units
Operating Junction Temperature Range	TJ	-40	—	+125	°C
Operating Ambient Temperature Range	TA	-40	—	+85	°C
Power Dissipation: Internal Chip Power Dissipation: PINT = VDD x (IDD-Σ IOH) I/O Pin Power Dissipation: PI/O = Σ ((VDD - VOH) x IOH) + Σ (VOL x IOL)	PD	PINT + PI/O			W
Maximum Allowed Power Dissipation	PDMAX	(TJ - TA) / θJA			W

TABLE 8-2: THERMAL PACKAGING CHARACTERISTICS

Characteristics	Symbol	Typ.	Max.	Units
Package Thermal Resistance, 44-pin QFN	θJA	32	—	°C/W
Package Thermal Resistance, 44-pin TQFP	θJA	45	—	°C/W

TABLE 8-3: OPERATING VOLTAGE AND CURRENT

Symbol	Characteristics	Min	Typ	Max	Units
VDD	Supply Voltage	2.4	—	3.6	V
IDD	Operating Current	—	20	30	mA
ISLP	Sleep Current	—	20	—	µA

MTCH6301 PROJECTED CAPACITIVE TOUCH CONTROLLER

TABLE 8-4: PIN INPUT AND OUTPUT SPECIFICATIONS

Symbol	Characteristic / Pins	Min.	Max.	Units	Conditions
V _{IL}	Input Low Voltage				
	RX, TX	V _{SS}	0.15 V _{DD}	V	—
	SDA, SCL	V _{SS}	0.3 V _{DD}	V	Note 1
V _{IH}	Input High Voltage				
	RX, TX	0.65 V _{DD}	V _{DD}	V	Note 1
	SDA, SCL	0.65 V _{DD}	V _{DD}	V	Note 1
V _{OL}	Output Low Voltage				
	INT, RX, TX	V _{SS}	0.4	V	I _{OL} < 10 mA, V _{DD} = 3.3V
	SDA, SCL	V _{SS}	0.4	V	I _{OL} < 10 mA, V _{DD} = 3.3V ^(1,2)
V _{OH}	Output High Voltage				
	INT, RX, TX	2.4	V _{DD}	V	I _{OH} < 10mA, V _{DD} = 3.3V
	SDA, SCL	—	—	V	Note 2
V _{BOR}	Brown-out event on V _{DD} Transition high-to-low	2.0	2.3	V	Min. not tested

Note 1: Parameter is characterized, but not tested.

2: Open drain structure.

8.3 AC Characteristics and Timing Parameters

TABLE 8-5: AC CHARACTERISTICS AND TIMING PARAMETERS

Symbol	Characteristic	Min.	Typ.	Max	Units	Conditions
TPU	Power-up Period	—	400	—	μs	Notes 1, 2
TBOR	Brown-out Pulse Width (Low)	—	1	—	μs	Note 1

Note 1: Parameter is characterized, but not tested.

2: Power-up period is for core operation to begin, and does not reflect response time to a touch.

FIGURE 8-1: I²C™ BUS START/STOP BIT TIMING CHARACTERISTICS

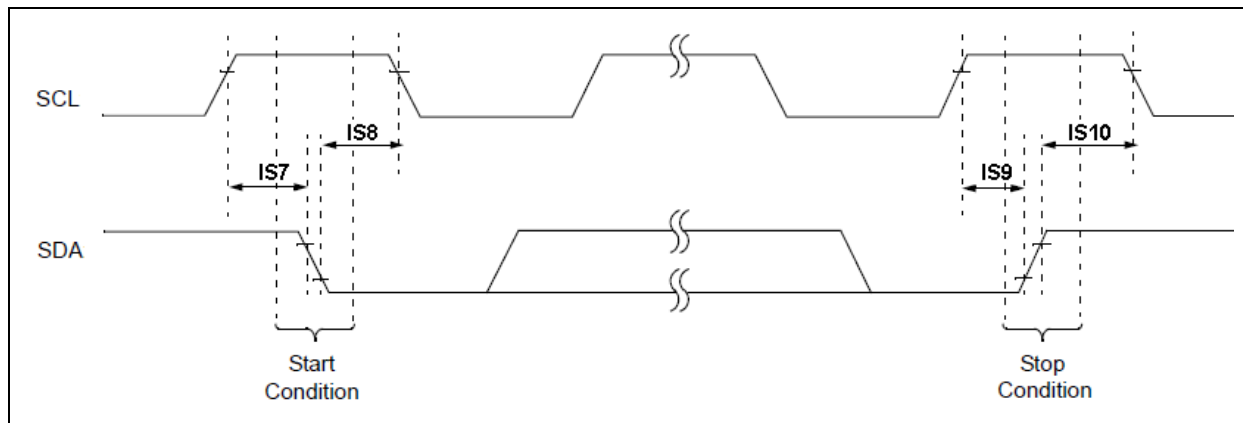

MTCH6301 PROJECTED CAPACITIVE TOUCH CONTROLLER

FIGURE 8-2: I²C™ BUS DATA TIMING CHARACTERISTICS

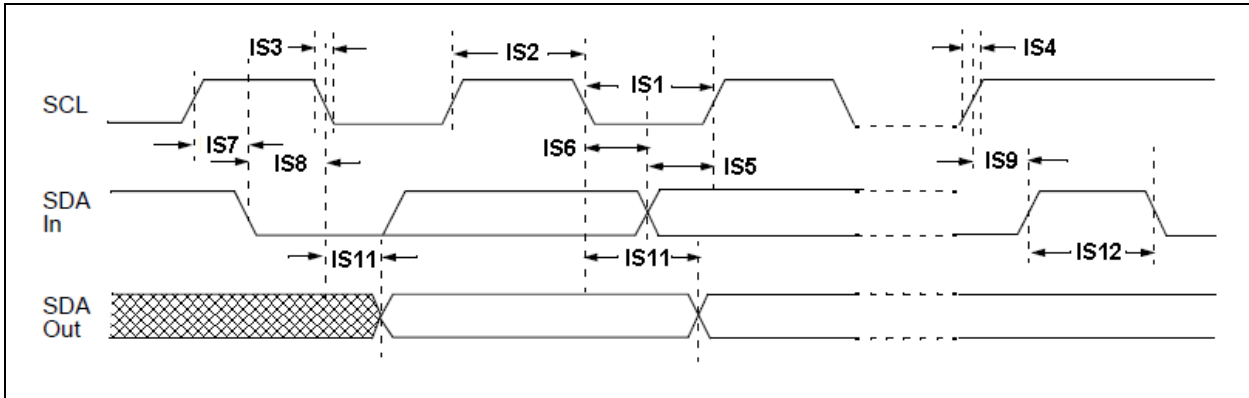

TABLE 8-6: I²C™ BUS DATA TIMING REQUIREMENTS

Parameter Number	Symbol	Characteristic	Min.	Max.	Units	Conditions	
IS1	TLO:SCL	Clock Low Time	100 kHz Mode	4.7	—	μs	—
			400 kHz Mode	1.3	—	μs	
IS2	THI:SCL	Clock High Time	100 kHz Mode	4.0	—	μs	—
			400 kHz Mode	.6	—	μs	
IS3	TF:SCL	SDA and SCL Fall Time	100 kHz Mode	—	300	ns	—
			400 kHz Mode	20+0.1 CB	300	ns	
IS4	TR:SCL	SDA and SCL Rise Time	100 kHz Mode	—	1000	ns	—
			400 kHz Mode	20+0.1 CB	300	ns	
IS5	TSU:DAT	Data Input Setup Time	100 kHz Mode	250	—	ns	—
			400 kHz Mode	100	—	ns	
IS6	THD:DAT	Data Input Hold Time	100 kHz Mode	0	—	ns	—
			400 kHz Mode	0	0.9	μs	
IS7	THD:STA	Start Condition Setup Time	100 kHz Mode	4700	—	ns	Only relevant for repeated start condition
			400 kHz Mode	600	—	ns	
IS8	THD:STA	Start Condition Hold Time	100 kHz Mode	4000	—	ns	After this period, the first clock pulse is generated
			400 kHz Mode	600	—	ns	
IS9	TSU:STO	Stop Condition Setup Time	100 kHz Mode	4000	—	ns	—
			400 kHz Mode	600	—	ns	
IS10	THD:STO	Stop Condition Hold Time	100 kHz Mode	4000	—	ns	—
			400 kHz Mode	600	—	ns	
IS11	TAA:SCL	Output Valid from Clock	100 kHz Mode	0	3500	ns	—
			400 kHz Mode	0	1000	ns	
IS12	TDF:SDA	Bus Free Time	100 kHz Mode	4.7	—	μs	Time bus must be free before new transmission can start
			400 kHz Mode	1.3	—	μs	
	CB	SCL, SDC Capacitive Loading	—	400	pF	Parameter is characterized, but not tested	

MTCH6301 PROJECTED CAPACITIVE TOUCH CONTROLLER

9.0 ORDERING INFORMATION

TABLE 9-1: ORDERING INFORMATION

Part Number	Pin Package	Packing
MTCH6301-I/PT	44 TQFP 10x10x1mm	Tray
MTCH6301-I/ML	44 QFN 8x8x0.9mm	Tube
MTCH6301T-I/PT	44 TQFP 10x10x1mm	T/R
MTCH6301T-I/ML	44 QFN 8x8x0.9mm	T/R

MTCH6301 PROJECTED CAPACITIVE TOUCH CONTROLLER

10.0 PACKAGING INFORMATION

44-Lead QFN (8x8x0.9 mm)

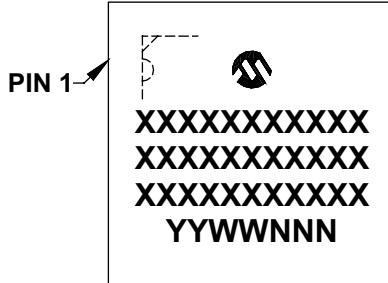

Example

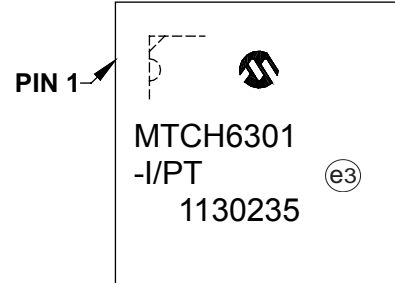

44-Lead TQFP (10x10x1 mm)

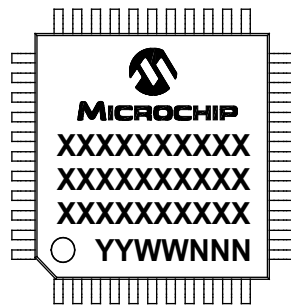

Example

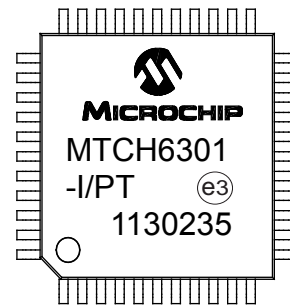

Legend:	XX...X	Customer-specific information
	Y	Year code (last digit of calendar year)
	YY	Year code (last 2 digits of calendar year)
	WW	Week code (week of January 1 is week '01')
	NNN	Alphanumeric traceability code
	(e3)	Pb-free JEDEC designator for Matte Tin (Sn)
	*	This package is Pb-free. The Pb-free JEDEC designator (e3) can be found on the outer packaging for this package.

Note: In the event the full Microchip part number cannot be marked on one line, it will be carried over to the next line, thus limiting the number of available characters for customer-specific information.

MTCH6301 PROJECTED CAPACITIVE TOUCH CONTROLLER

44-Lead Plastic Quad Flat, No Lead Package (ML) - 8x8 mm Body [QFN]

Note: For the most current package drawings, please see the Microchip Packaging Specification located at <http://www.microchip.com/packaging>

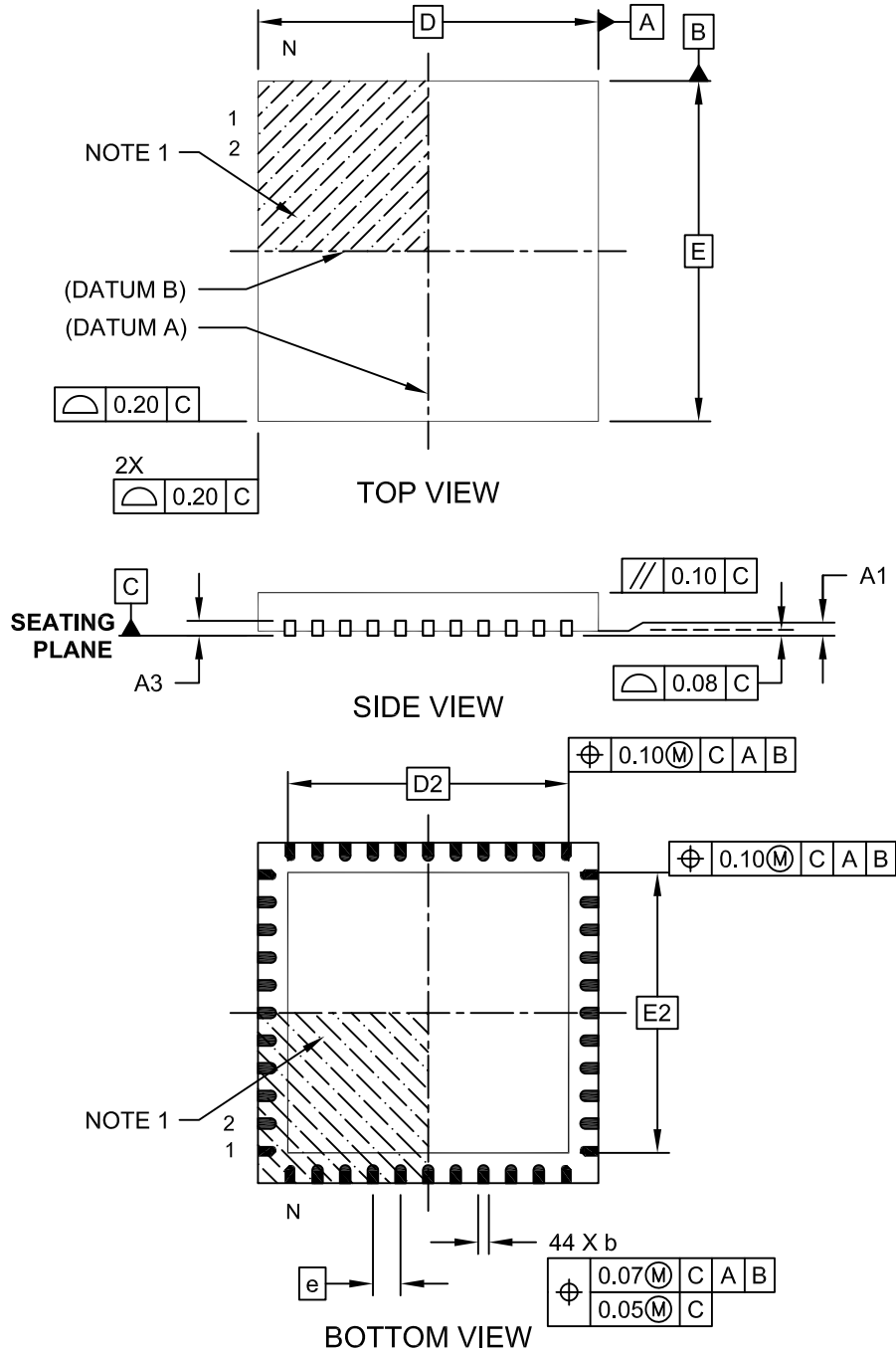

Microchip Technology Drawing C04-103C Sheet 1 of 2

MTCH6301 PROJECTED CAPACITIVE TOUCH CONTROLLER

44-Lead Plastic Quad Flat, No Lead Package (ML) - 8x8 mm Body [QFN]

Note: For the most current package drawings, please see the Microchip Packaging Specification located at <http://www.microchip.com/packaging>

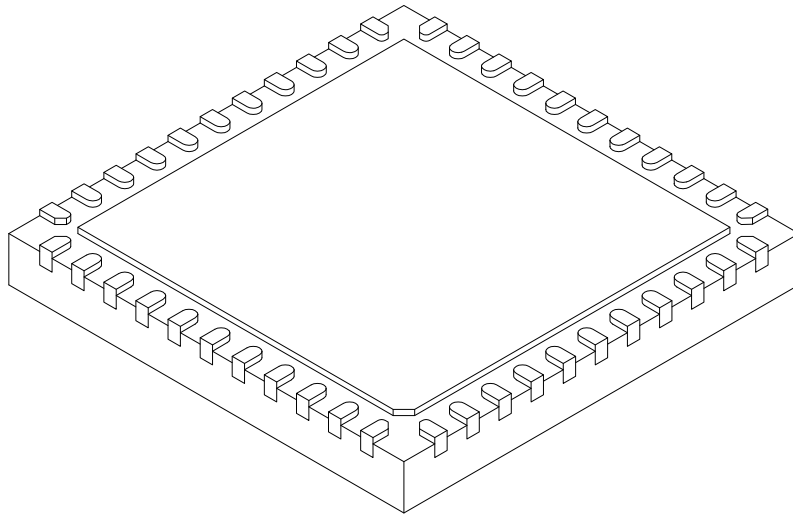

Dimension Limits	Units	MILLIMETERS		
		MIN	NOM	MAX
Number of Pins	N	44		
Pitch	e	0.65 BSC		
Overall Height	A	0.80	0.90	1.00
Standoff	A1	0.00	0.02	0.05
Terminal Thickness	A3	0.20 REF		
Overall Width	E	8.00 BSC		
Exposed Pad Width	E2	6.25	6.45	6.60
Overall Length	D	8.00 BSC		
Exposed Pad Length	D2	6.25	6.45	6.60
Terminal Width	b	0.20	0.30	0.35
Terminal Length	L	0.30	0.40	0.50
Terminal-to-Exposed-Pad	K	0.20	-	-

Notes:

1. Pin 1 visual index feature may vary, but must be located within the hatched area.
2. Package is saw singulated
3. Dimensioning and tolerancing per ASME Y14.5M

BSC: Basic Dimension. Theoretically exact value shown without tolerances.

REF: Reference Dimension. usually without tolerance. for information purposes only.

Microchip Technology Drawing C04-103C Sheet 2 of 2

MTCH6301 PROJECTED CAPACITIVE TOUCH CONTROLLER

44-Lead Plastic Quad Flat, No Lead Package (ML) - 8x8 mm Body [QFN]

Note: For the most current package drawings, please see the Microchip Packaging Specification located at <http://www.microchip.com/packaging>

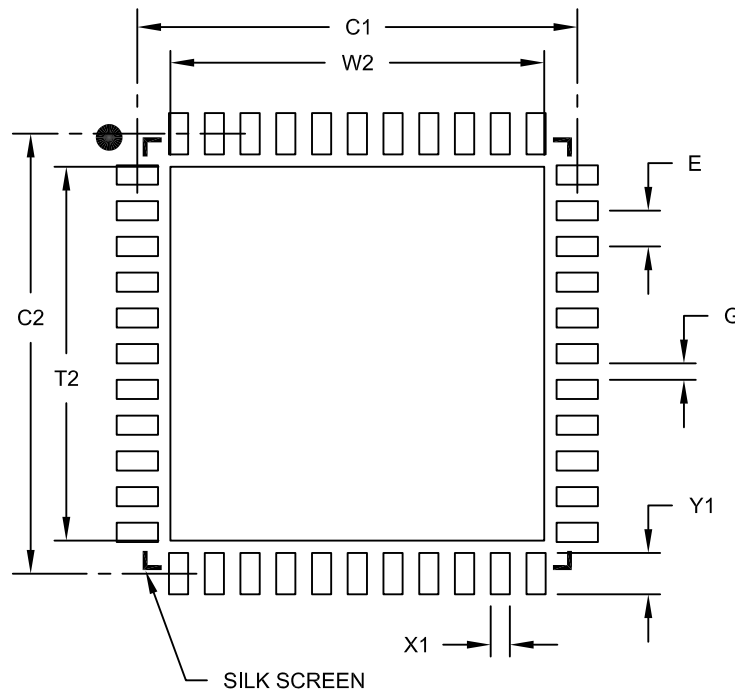

RECOMMENDED LAND PATTERN

Dimension Limits	Units	MILLIMETERS		
		MIN	NOM	MAX
Contact Pitch	E	0.65 BSC		
Optional Center Pad Width	W2			6.60
Optional Center Pad Length	T2			6.60
Contact Pad Spacing	C1		8.00	
Contact Pad Spacing	C2		8.00	
Contact Pad Width (X44)	X1			0.35
Contact Pad Length (X44)	Y1			0.85
Distance Between Pads	G	0.25		

Notes:

1. Dimensioning and tolerancing per ASME Y14.5M

BSC: Basic Dimension. Theoretically exact value shown without tolerances.

Microchip Technology Drawing No. C04-2103B

MTCH6301 PROJECTED CAPACITIVE TOUCH CONTROLLER

44-Lead Plastic Thin Quad Flatpack (PT) – 10x10x1 mm Body, 2.00 mm [TQFP]

Note: For the most current package drawings, please see the Microchip Packaging Specification located at <http://www.microchip.com/packaging>

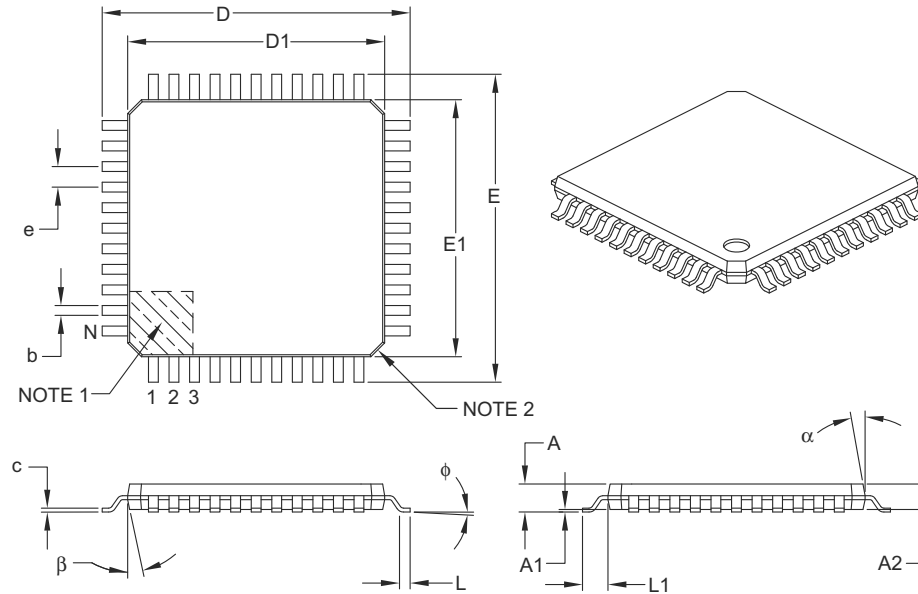

Dimension Limits	Units	MILLIMETERS		
		MIN	NOM	MAX
Number of Leads	N	44		
Lead Pitch	e	0.80 BSC		
Overall Height	A	–	–	1.20
Molded Package Thickness	A2	0.95	1.00	1.05
Standoff	A1	0.05	–	0.15
Foot Length	L	0.45	0.60	0.75
Footprint	L1	1.00 REF		
Foot Angle	ϕ	0°	3.5°	7°
Overall Width	E	12.00 BSC		
Overall Length	D	12.00 BSC		
Molded Package Width	E1	10.00 BSC		
Molded Package Length	D1	10.00 BSC		
Lead Thickness	c	0.09	–	0.20
Lead Width	b	0.30	0.37	0.45
Mold Draft Angle Top	α	11°	12°	13°
Mold Draft Angle Bottom	β	11°	12°	13°

Notes:

- Pin 1 visual index feature may vary, but must be located within the hatched area.
- Chamfers at corners are optional; size may vary.
- Dimensions D1 and E1 do not include mold flash or protrusions. Mold flash or protrusions shall not exceed 0.25 mm per side.
- Dimensioning and tolerancing per ASME Y14.5M.

BSC: Basic Dimension. Theoretically exact value shown without tolerances.

REF: Reference Dimension, usually without tolerance, for information purposes only.

Microchip Technology Drawing C04-076B

MTCH6301 PROJECTED CAPACITIVE TOUCH CONTROLLER

44-Lead Plastic Thin Quad Flatpack (PT) 10X10X1 mm Body, 2.00 mm Footprint [TQFP]

Note: For the most current package drawings, please see the Microchip Packaging Specification located at <http://www.microchip.com/packaging>

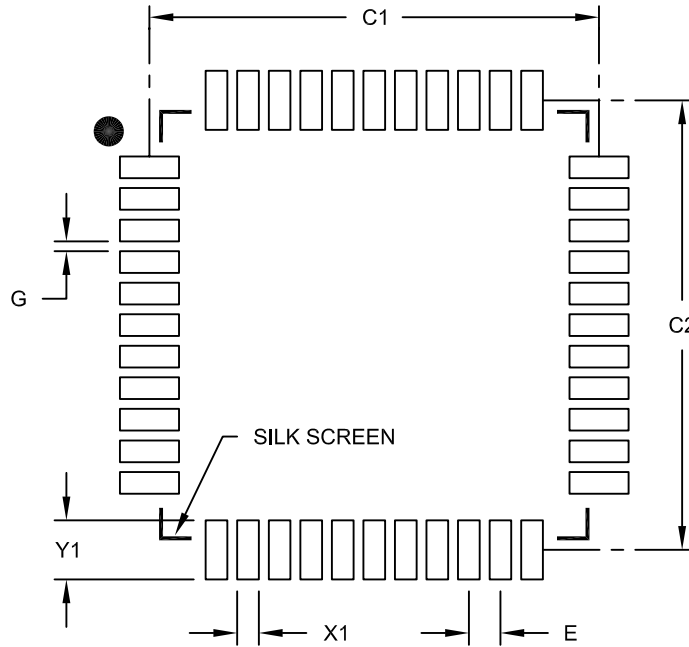

RECOMMENDED LAND PATTERN

Dimension Limits	Units	MILLIMETERS		
		MIN	NOM	MAX
Contact Pitch	E	0.80 BSC		
Contact Pad Spacing	C1		11.40	
Contact Pad Spacing	C2		11.40	
Contact Pad Width (X44)	X1			0.55
Contact Pad Length (X44)	Y1			1.50
Distance Between Pads	G	0.25		

Notes:

1. Dimensioning and tolerancing per ASME Y14.5M

BSC: Basic Dimension. Theoretically exact value shown without tolerances.

Microchip Technology Drawing No. C04-2076B

Note the following details of the code protection feature on Microchip devices:

- Microchip products meet the specification contained in their particular Microchip Data Sheet.
- Microchip believes that its family of products is one of the most secure families of its kind on the market today, when used in the intended manner and under normal conditions.
- There are dishonest and possibly illegal methods used to breach the code protection feature. All of these methods, to our knowledge, require using the Microchip products in a manner outside the operating specifications contained in Microchip's Data Sheets. Most likely, the person doing so is engaged in theft of intellectual property.
- Microchip is willing to work with the customer who is concerned about the integrity of their code.
- Neither Microchip nor any other semiconductor manufacturer can guarantee the security of their code. Code protection does not mean that we are guaranteeing the product as “unbreakable.”

Code protection is constantly evolving. We at Microchip are committed to continuously improving the code protection features of our products. Attempts to break Microchip's code protection feature may be a violation of the Digital Millennium Copyright Act. If such acts allow unauthorized access to your software or other copyrighted work, you may have a right to sue for relief under that Act.

Information contained in this publication regarding device applications and the like is provided only for your convenience and may be superseded by updates. It is your responsibility to ensure that your application meets with your specifications. MICROCHIP MAKES NO REPRESENTATIONS OR WARRANTIES OF ANY KIND WHETHER EXPRESS OR IMPLIED, WRITTEN OR ORAL, STATUTORY OR OTHERWISE, RELATED TO THE INFORMATION, INCLUDING BUT NOT LIMITED TO ITS CONDITION, QUALITY, PERFORMANCE, MERCHANTABILITY OR FITNESS FOR PURPOSE. Microchip disclaims all liability arising from this information and its use. Use of Microchip devices in life support and/or safety applications is entirely at the buyer's risk, and the buyer agrees to defend, indemnify and hold harmless Microchip from any and all damages, claims, suits, or expenses resulting from such use. No licenses are conveyed, implicitly or otherwise, under any Microchip intellectual property rights.

Trademarks

The Microchip name and logo, the Microchip logo, dsPIC, FlashFlex, KEELOQ, KEELOQ logo, MPLAB, PIC, PICmicro, PICSTART, PIC³² logo, rPIC, SST, SST Logo, SuperFlash and UNI/O are registered trademarks of Microchip Technology Incorporated in the U.S.A. and other countries.

FilterLab, Hampshire, HI-TECH C, Linear Active Thermistor, MTP, SEEVAL and The Embedded Control Solutions Company are registered trademarks of Microchip Technology Incorporated in the U.S.A.

Silicon Storage Technology is a registered trademark of Microchip Technology Inc. in other countries.

Analog-for-the-Digital Age, Application Maestro, BodyCom, chipKIT, chipKIT logo, CodeGuard, dsPICDEM, dsPICDEM.net, dsPICworks, dsSPEAK, ECAN, ECONOMONITOR, FanSense, HI-TIDE, In-Circuit Serial Programming, ICSP, Mindi, MiWi, MPASM, MPF, MPLAB Certified logo, MPLIB, MPLINK, mTouch, Omniclient Code Generation, PICC, PICC-18, PICDEM, PICDEM.net, PICkit, PICtail, REAL ICE, rLAB, Select Mode, SQI, Serial Quad I/O, Total Endurance, TSHARC, UniWinDriver, WiperLock, ZENA and Z-Scale are trademarks of Microchip Technology Incorporated in the U.S.A. and other countries.

SQTP is a service mark of Microchip Technology Incorporated in the U.S.A.

GestIC and ULPP are registered trademarks of Microchip Technology Germany II GmbH & Co. & KG, a subsidiary of Microchip Technology Inc., in other countries.

All other trademarks mentioned herein are property of their respective companies.

© 2012, Microchip Technology Incorporated, Printed in the U.S.A., All Rights Reserved.

 Printed on recycled paper.

ISBN: 978-1-62076-653-8

QUALITY MANAGEMENT SYSTEM
CERTIFIED BY DNV
== ISO/TS 16949 ==

Microchip received ISO/TS-16949:2009 certification for its worldwide headquarters, design and wafer fabrication facilities in Chandler and Tempe, Arizona; Gresham, Oregon and design centers in California and India. The Company's quality system processes and procedures are for its PIC[®] MCUs and dsPIC[®] DSCs, KEELOQ[®] code hopping devices, Serial EEPROMs, microperipherals, nonvolatile memory and analog products. In addition, Microchip's quality system for the design and manufacture of development systems is ISO 9001:2000 certified.



MICROCHIP

Worldwide Sales and Service

AMERICAS

Corporate Office
2355 West Chandler Blvd.
Chandler, AZ 85224-6199
Tel: 480-792-7200
Fax: 480-792-7277
Technical Support:
<http://www.microchip.com/support>
Web Address:
www.microchip.com

Atlanta
Duluth, GA
Tel: 678-957-9614
Fax: 678-957-1455

Boston
Westborough, MA
Tel: 774-760-0087
Fax: 774-760-0088

Chicago
Itasca, IL
Tel: 630-285-0071
Fax: 630-285-0075

Cleveland
Independence, OH
Tel: 216-447-0464
Fax: 216-447-0643

Dallas
Addison, TX
Tel: 972-818-7423
Fax: 972-818-2924

Detroit
Farmington Hills, MI
Tel: 248-538-2250
Fax: 248-538-2260

Indianapolis
Noblesville, IN
Tel: 317-773-8323
Fax: 317-773-5453

Los Angeles
Mission Viejo, CA
Tel: 949-462-9523
Fax: 949-462-9608

Santa Clara
Santa Clara, CA
Tel: 408-961-6444
Fax: 408-961-6445

Toronto
Mississauga, Ontario,
Canada
Tel: 905-673-0699
Fax: 905-673-6509

ASIA/PACIFIC

Asia Pacific Office
Suites 3707-14, 37th Floor
Tower 6, The Gateway
Harbour City, Kowloon
Hong Kong
Tel: 852-2401-1200
Fax: 852-2401-3431

Australia - Sydney
Tel: 61-2-9868-6733
Fax: 61-2-9868-6755

China - Beijing
Tel: 86-10-8569-7000
Fax: 86-10-8528-2104

China - Chengdu
Tel: 86-28-8665-5511
Fax: 86-28-8665-7889

China - Chongqing
Tel: 86-23-8980-9588
Fax: 86-23-8980-9500

China - Hangzhou
Tel: 86-571-2819-3187
Fax: 86-571-2819-3189

China - Hong Kong SAR
Tel: 852-2401-1200
Fax: 852-2401-3431

China - Nanjing
Tel: 86-25-8473-2460
Fax: 86-25-8473-2470

China - Qingdao
Tel: 86-532-8502-7355
Fax: 86-532-8502-7205

China - Shanghai
Tel: 86-21-5407-5533
Fax: 86-21-5407-5066

China - Shenyang
Tel: 86-24-2334-2829
Fax: 86-24-2334-2393

China - Shenzhen
Tel: 86-755-8203-2660
Fax: 86-755-8203-1760

China - Wuhan
Tel: 86-27-5980-5300
Fax: 86-27-5980-5118

China - Xian
Tel: 86-29-8833-7252
Fax: 86-29-8833-7256

China - Xiamen
Tel: 86-592-2388138
Fax: 86-592-2388130

China - Zhuhai
Tel: 86-756-3210040
Fax: 86-756-3210049

ASIA/PACIFIC

India - Bangalore
Tel: 91-80-3090-4444
Fax: 91-80-3090-4123

India - New Delhi
Tel: 91-11-4160-8631
Fax: 91-11-4160-8632

India - Pune
Tel: 91-20-2566-1512
Fax: 91-20-2566-1513

Japan - Osaka
Tel: 81-66-152-7160
Fax: 81-66-152-9310

Japan - Yokohama
Tel: 81-45-471-6166
Fax: 81-45-471-6122

Korea - Daegu
Tel: 82-53-744-4301
Fax: 82-53-744-4302

Korea - Seoul
Tel: 82-2-554-7200
Fax: 82-2-558-5932 or
82-2-558-5934

Malaysia - Kuala Lumpur
Tel: 60-3-6201-9857
Fax: 60-3-6201-9859

Malaysia - Penang
Tel: 60-4-227-8870
Fax: 60-4-227-4068

Philippines - Manila
Tel: 63-2-634-9065
Fax: 63-2-634-9069

Singapore
Tel: 65-6334-8870
Fax: 65-6334-8850

Taiwan - Hsin Chu
Tel: 886-3-5778-366
Fax: 886-3-5770-955

Taiwan - Kaohsiung
Tel: 886-7-536-4818
Fax: 886-7-330-9305

Taiwan - Taipei
Tel: 886-2-2500-6610
Fax: 886-2-2508-0102

Thailand - Bangkok
Tel: 66-2-694-1351
Fax: 66-2-694-1350

EUROPE

Austria - Wels
Tel: 43-7242-2244-39
Fax: 43-7242-2244-393

Denmark - Copenhagen
Tel: 45-4450-2828
Fax: 45-4485-2829

France - Paris
Tel: 33-1-69-53-63-20
Fax: 33-1-69-30-90-79

Germany - Munich
Tel: 49-89-627-144-0
Fax: 49-89-627-144-44

Italy - Milan
Tel: 39-0331-742611
Fax: 39-0331-466781

Netherlands - Drunen
Tel: 31-416-690399
Fax: 31-416-690340

Spain - Madrid
Tel: 34-91-708-08-90
Fax: 34-91-708-08-91

UK - Wokingham
Tel: 44-118-921-5869
Fax: 44-118-921-5820

11/29/11



Компания «ЭлектроПласт» предлагает заключение долгосрочных отношений при поставках импортных электронных компонентов на взаимовыгодных условиях!

Наши преимущества:

- Оперативные поставки широкого спектра электронных компонентов отечественного и импортного производства напрямую от производителей и с крупнейших мировых складов;
- Поставка более 17-ти миллионов наименований электронных компонентов;
- Поставка сложных, дефицитных, либо снятых с производства позиций;
- Оперативные сроки поставки под заказ (от 5 рабочих дней);
- Экспресс доставка в любую точку России;
- Техническая поддержка проекта, помощь в подборе аналогов, поставка прототипов;
- Система менеджмента качества сертифицирована по Международному стандарту ISO 9001;
- Лицензия ФСБ на осуществление работ с использованием сведений, составляющих государственную тайну;
- Поставка специализированных компонентов (Xilinx, Altera, Analog Devices, Intersil, Interpoint, Microsemi, Aeroflex, Peregrine, Syfer, Eurofarad, Texas Instrument, Miteq, Cobham, E2V, MA-COM, Hittite, Mini-Circuits, General Dynamics и др.);

Помимо этого, одним из направлений компании «ЭлектроПласт» является направление «Источники питания». Мы предлагаем Вам помощь Конструкторского отдела:

- Подбор оптимального решения, техническое обоснование при выборе компонента;
- Подбор аналогов;
- Консультации по применению компонента;
- Поставка образцов и прототипов;
- Техническая поддержка проекта;
- Защита от снятия компонента с производства.



Как с нами связаться

Телефон: 8 (812) 309 58 32 (многоканальный)

Факс: 8 (812) 320-02-42

Электронная почта: org@eplast1.ru

Адрес: 198099, г. Санкт-Петербург, ул. Калинина, дом 2, корпус 4, литера А.