

## Standard Sinterglass Diode

### Features

- High temperature metallurgically bonded constructed rectifiers
- Cavity-free glass passivated junction in DO-204AP package
- Hermetically sealed package
- 1.0 ampere operation at  $T_{amb} = 100\text{ }^{\circ}\text{C}$  with no thermal runaway

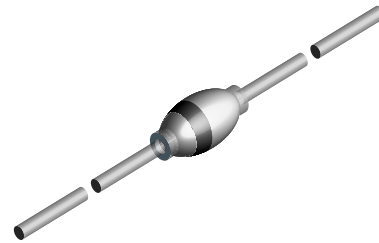

17031

### Mechanical Data

**Case:** DO-204AP Sintered glass case

**Terminals:** Solder plated axial leads, solderable per MIL-STD-750, Method 2026

**Mounting Position:** Any

**Weight:** approx. 560 mg

**Polarity:** Color band denotes cathode end

### Parts Table

Part	Type differentiation	Package
G1A	$V_{RRM} = 50\text{ V}$	DO-204AP(G-1)
G1B	$V_{RRM} = 100\text{ V}$	DO-204AP(G-1)
G1D	$V_{RRM} = 200\text{ V}$	DO-204AP(G-1)
G1G	$V_{RRM} = 400\text{ V}$	DO-204AP(G-1)
G1J	$V_{RRM} = 600\text{ V}$	DO-204AP(G-1)
G1K	$V_{RRM} = 800\text{ V}$	DO-204AP(G-1)
G1M	$V_{RRM} = 1000\text{ V}$	DO-204AP(G-1)

### Absolute Maximum Ratings

$T_{amb} = 25\text{ }^{\circ}\text{C}$ , unless otherwise specified

Parameter	Test condition	Part	Symbol	Value	Unit
Reverse voltage = Repetitive peak reverse voltage	see electrical characteristics	G1A	$V_R = V_{RRM}$	50	V
		G1B	$V_R = V_{RRM}$	100	V
		G1D	$V_R = V_{RRM}$	200	V
		G1G	$V_R = V_{RRM}$	400	V
		G1J	$V_R = V_{RRM}$	600	V
		G1K	$V_R = V_{RRM}$	800	V
		G1M	$V_R = V_{RRM}$	1000	V
Maximum average forward rectified current	0.375 " (9.5 mm) lead length at $T_{amb} = 100\text{ }^{\circ}\text{C}$		$I_{F(AV)}$	1.0	A

Parameter	Test condition	Part	Symbol	Value	Unit
Peak forward surge current	8.3 ms single half sine-wave superimposed on rated load (JEDEC Method)		$I_{FSM}$	50	A
Maximum full load reverse current	full cycle average 0.375 " (9.5 mm) lead length at $T_{amb} = 100\text{ }^{\circ}\text{C}$		$I_{R(AV)}$	200	$\mu\text{A}$
Operating junction and storage temperature range			$T_J, T_{STG}$	- 55 to + 175	$^{\circ}\text{C}$

### Maximum Thermal Resistance

$T_{amb} = 25\text{ }^{\circ}\text{C}$ , unless otherwise specified

Parameter	Test condition	Symbol	Value	Unit
Typical thermal resistance <sup>1)</sup>		$R_{\theta JL}$	55	K/W

<sup>1)</sup> Thermal resistance from junction to ambient at 0.375 " (9.5 mm) lead length, P.C.B. mounted

### Electrical Characteristics

$T_{amb} = 25\text{ }^{\circ}\text{C}$ , unless otherwise specified

Parameter	Test condition	Part	Symbol	Min	Typ.	Max	Unit
Maximum instantaneous forward voltage	$I_F = 1\text{ A}$	G1A	$V_F$			1.2	V
		G1B	$V_F$			1.2	V
		G1D	$V_F$			1.1	V
		G1G	$V_F$			1.1	V
		G1J	$V_F$			1.1	V
		G1K	$V_F$			1.1	V
		G1M	$V_F$			1.1	V
Maximum reverse current	$V_R = V_{RRM}, T_{amb} = 25\text{ }^{\circ}\text{C}$		$I_R$			2.0	$\mu\text{A}$
	$V_R = V_{RRM}, T_{amb} = 150\text{ }^{\circ}\text{C}$		$I_R$			100	$\mu\text{A}$
Typical reverse recovery time	$I_F = 0.5\text{ A}, I_R = 1.0\text{ A}, I_{rr} = 0.25\text{ A}$		$t_{rr}$		1.5		$\mu\text{s}$
Typical junction capacitance	$V_R = 4.0\text{ V}, f = 1\text{ MHz}$		$C_j$		15		pF

### Typical Characteristics ( $T_{amb} = 25\text{ }^{\circ}\text{C}$ unless otherwise specified)

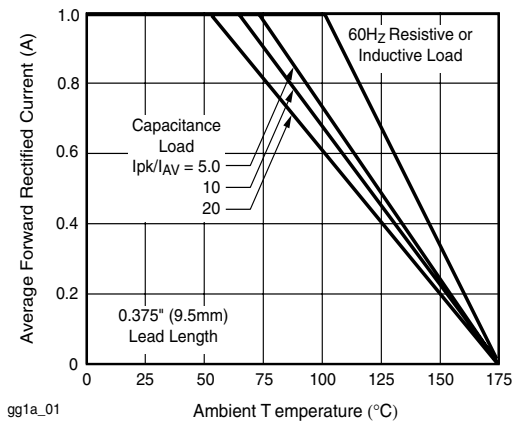

Figure 1. Forward Current Derating Curve

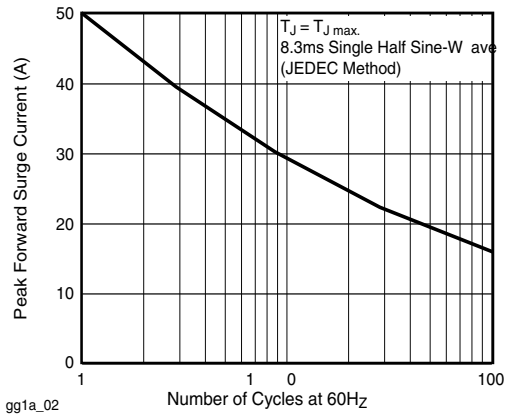

Figure 2. Maximum Non-Repetitive Peak Forward Surge Current

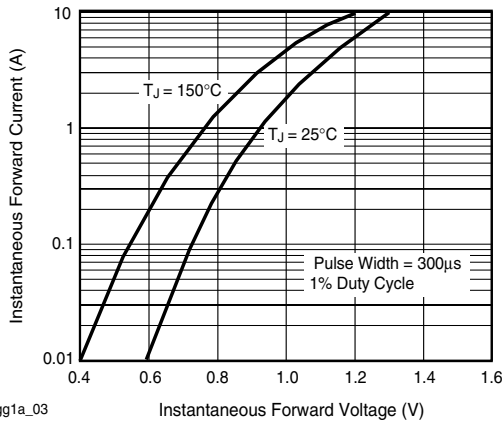

Figure 3. Typical Instantaneous Forward Characteristics

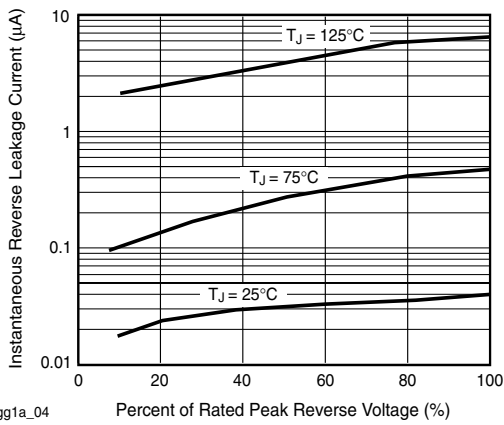

Figure 4. Typical Reverse Characteristics

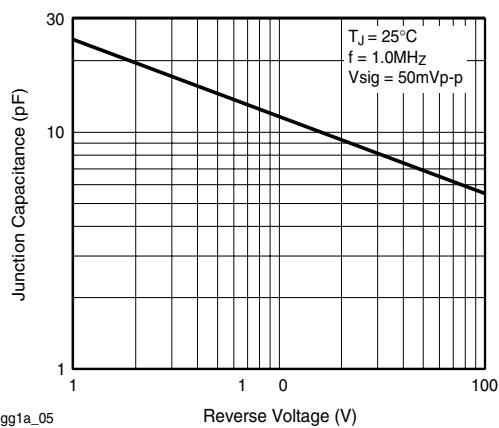
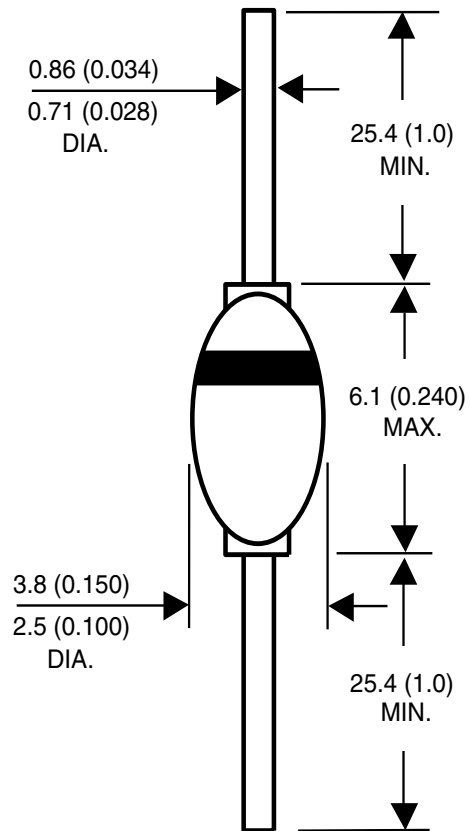

Figure 5. Typical Junction Capacitance

## Package Dimensions in mm (Inches)



17030



## **Ozone Depleting Substances Policy Statement**

It is the policy of **Vishay Semiconductor GmbH** to

1. Meet all present and future national and international statutory requirements.
2. Regularly and continuously improve the performance of our products, processes, distribution and operating systems with respect to their impact on the health and safety of our employees and the public, as well as their impact on the environment.

It is particular concern to control or eliminate releases of those substances into the atmosphere which are known as ozone depleting substances (ODSs).

The Montreal Protocol (1987) and its London Amendments (1990) intend to severely restrict the use of ODSs and forbid their use within the next ten years. Various national and international initiatives are pressing for an earlier ban on these substances.

**Vishay Semiconductor GmbH** has been able to use its policy of continuous improvements to eliminate the use of ODSs listed in the following documents.

1. Annex A, B and list of transitional substances of the Montreal Protocol and the London Amendments respectively
2. Class I and II ozone depleting substances in the Clean Air Act Amendments of 1990 by the Environmental Protection Agency (EPA) in the USA
3. Council Decision 88/540/EEC and 91/690/EEC Annex A, B and C (transitional substances) respectively.

**Vishay Semiconductor GmbH** can certify that our semiconductors are not manufactured with ozone depleting substances and do not contain such substances.

**We reserve the right to make changes to improve technical design  
and may do so without further notice.**

Parameters can vary in different applications. All operating parameters must be validated for each customer application by the customer. Should the buyer use Vishay Semiconductors products for any unintended or unauthorized application, the buyer shall indemnify Vishay Semiconductors against all claims, costs, damages, and expenses, arising out of, directly or indirectly, any claim of personal damage, injury or death associated with such unintended or unauthorized use.

Vishay Semiconductor GmbH, P.O.B. 3535, D-74025 Heilbronn, Germany  
Telephone: 49 (0)7131 67 2831, Fax number: 49 (0)7131 67 2423



## Disclaimer

All product specifications and data are subject to change without notice.

Vishay Intertechnology, Inc., its affiliates, agents, and employees, and all persons acting on its or their behalf (collectively, "Vishay"), disclaim any and all liability for any errors, inaccuracies or incompleteness contained herein or in any other disclosure relating to any product.

Vishay disclaims any and all liability arising out of the use or application of any product described herein or of any information provided herein to the maximum extent permitted by law. The product specifications do not expand or otherwise modify Vishay's terms and conditions of purchase, including but not limited to the warranty expressed therein, which apply to these products.

No license, express or implied, by estoppel or otherwise, to any intellectual property rights is granted by this document or by any conduct of Vishay.

The products shown herein are not designed for use in medical, life-saving, or life-sustaining applications unless otherwise expressly indicated. Customers using or selling Vishay products not expressly indicated for use in such applications do so entirely at their own risk and agree to fully indemnify Vishay for any damages arising or resulting from such use or sale. Please contact authorized Vishay personnel to obtain written terms and conditions regarding products designed for such applications.

Product names and markings noted herein may be trademarks of their respective owners.



Компания «ЭлектроПласт» предлагает заключение долгосрочных отношений при поставках импортных электронных компонентов на взаимовыгодных условиях!

Наши преимущества:

- Оперативные поставки широкого спектра электронных компонентов отечественного и импортного производства напрямую от производителей и с крупнейших мировых складов;
- Поставка более 17-ти миллионов наименований электронных компонентов;
- Поставка сложных, дефицитных, либо снятых с производства позиций;
- Оперативные сроки поставки под заказ (от 5 рабочих дней);
- Экспресс доставка в любую точку России;
- Техническая поддержка проекта, помощь в подборе аналогов, поставка прототипов;
- Система менеджмента качества сертифицирована по Международному стандарту ISO 9001;
- Лицензия ФСБ на осуществление работ с использованием сведений, составляющих государственную тайну;
- Поставка специализированных компонентов (Xilinx, Altera, Analog Devices, Intersil, Interpoint, Microsemi, Aeroflex, Peregrine, Syfer, Eurofarad, Texas Instrument, Miteq, Cobham, E2V, MA-COM, Hittite, Mini-Circuits, General Dynamics и др.);

Помимо этого, одним из направлений компании «ЭлектроПласт» является направление «Источники питания». Мы предлагаем Вам помощь Конструкторского отдела:

- Подбор оптимального решения, техническое обоснование при выборе компонента;
- Подбор аналогов;
- Консультации по применению компонента;
- Поставка образцов и прототипов;
- Техническая поддержка проекта;
- Защита от снятия компонента с производства.



#### Как с нами связаться

**Телефон:** 8 (812) 309 58 32 (многоканальный)

**Факс:** 8 (812) 320-02-42

**Электронная почта:** [org@eplast1.ru](mailto:org@eplast1.ru)

**Адрес:** 198099, г. Санкт-Петербург, ул. Калинина, дом 2, корпус 4, литера А.