

**Features**

- Advanced Planar Technology
- Low On-Resistance
- Logic Level Gate Drive
- Dual N and P Channel MOSFET
- Dynamic dv/dt Rating
- 150°C Operating Temperature
- Fast Switching
- Lead-Free, RoHS Compliant
- Automotive Qualified \*

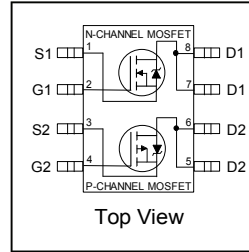

	N-CH	P-CH
$V_{DSS}$	30V	-30V
$R_{DS(on)}$ max.	0.05Ω	0.10Ω
$I_D$	4.7A	-3.5A



G	D	S
Gate	Drain	Source

**Description**

Specifically designed for Automotive applications, this cellular design of HEXFET® Power MOSFETs utilizes the latest processing techniques to achieve low on-resistance per silicon area. This benefit combined with the fast switching speed and ruggedized device design that HEXFET power MOSFETs are well known for, provides the designer with an extremely efficient and reliable device for use in Automotive and a wide variety of other applications.

Base part number	Package Type	Standard Pack		Orderable Part Number
		Form	Quantity	
AUIRF7309Q	SO-8	Tape and Reel	4000	AUIRF7309QTR

**Absolute Maximum Ratings**

Stresses beyond those listed under “Absolute Maximum Ratings” may cause permanent damage to the device. These are stress ratings only; and functional operation of the device at these or any other condition beyond those indicated in the specifications is not implied. Exposure to absolute-maximum-rated conditions for extended periods may affect device reliability. The thermal resistance and power dissipation ratings are measured under board mounted and still air conditions. Ambient temperature (TA) is 25°C, unless otherwise specified.

Symbol	Parameter	Max.		Units
		N-Channel	P-Channel	
$I_D @ T_A = 25^\circ C$	10 Sec. Pulsed Drain Current, $V_{GS} @ 10V$	4.7	-3.5	A
$I_D @ T_A = 25^\circ C$	Continuous Drain Current, $V_{GS} @ 10V$	4.0	-3.0	
$I_D @ T_A = 70^\circ C$	Continuous Drain Current, $V_{GS} @ 10V$	3.2	-2.4	
$I_{DM}$	Pulsed Drain Current ①	16	-12	
$P_D @ T_A = 25^\circ C$	Maximum Power Dissipation ④	1.4		W
	Linear Derating Factor④	0.011		W/°C
$V_{GS}$	Gate-to-Source Voltage	± 20		V
dv/dt	Peak Diode Recovery dv/dt ②	6.9	-6.0	V/ns
$T_J$ $T_{STG}$	Operating Junction and Storage Temperature Range	-55 to + 150		°C

**Thermal Resistance**

Symbol	Parameter	Typ.	Max.	Units
$R_{\theta JA}$	Junction-to-Ambient ( PCB Mount, steady state) ④	—	90	°C/W

HEXFET® is a registered trademark of Infineon.

\*Qualification standards can be found at [www.infineon.com](http://www.infineon.com)

**Static @ T<sub>J</sub> = 25°C (unless otherwise specified)**

	Parameter		Min.	Typ.	Max.	Units	Conditions
V <sub>(BR)DSS</sub>	Drain-to-Source Breakdown Voltage	N-Ch	30	—	—	V	V <sub>GS</sub> = 0V, I <sub>D</sub> = 250μA
		P-Ch	-30	—	—		V <sub>GS</sub> = 0V, I <sub>D</sub> = -250μA
ΔV <sub>(BR)DSS</sub> /ΔT <sub>J</sub>	Breakdown Voltage Temp. Coefficient	N-Ch	—	0.032	—	V/°C	Reference to 25°C, I <sub>D</sub> = 1mA
		P-Ch	—	-0.037	—		Reference to 25°C, I <sub>D</sub> = -1mA
R <sub>DS(on)</sub>	Static Drain-to-Source On-Resistance	N-Ch	—	—	0.050	Ω	V <sub>GS</sub> = 10V, I <sub>D</sub> = 2.4A ③
			—	—	0.080		V <sub>GS</sub> = 4.5V, I <sub>D</sub> = 2.0A ③
		P-Ch	—	—	0.10		V <sub>GS</sub> = -10V, I <sub>D</sub> = -1.8A ③
			—	—	0.16		V <sub>GS</sub> = -4.5V, I <sub>D</sub> = -1.5A ③
V <sub>GS(th)</sub>	Gate Threshold Voltage	N-Ch	1.0	—	3.0	V	V <sub>DS</sub> = V <sub>GS</sub> , I <sub>D</sub> = 250μA
		P-Ch	-1.0	—	-3.0		V <sub>DS</sub> = V <sub>GS</sub> , I <sub>D</sub> = -250μA
g <sub>fs</sub>	Forward Trans conductance	N-Ch	5.2	—	—	S	V <sub>DS</sub> = 15V, I <sub>D</sub> = 2.4A
		P-Ch	2.5	—	—		V <sub>DS</sub> = -24V, I <sub>D</sub> = -1.8A
I <sub>DSS</sub>	Drain-to-Source Leakage Current	N-Ch	—	—	1.0	μA	V <sub>DS</sub> = 24V, V <sub>GS</sub> = 0V
		P-Ch	—	—	-1.0		V <sub>DS</sub> = -24V, V <sub>GS</sub> = 0V
		N-Ch	—	—	25		V <sub>DS</sub> = 24V, V <sub>GS</sub> = 0V, T <sub>J</sub> = 125°C
		P-Ch	—	—	-25		V <sub>DS</sub> = -24V, V <sub>GS</sub> = 0V, T <sub>J</sub> = 125°C
I <sub>GSS</sub>	Gate-to-Source Forward Leakage	N-P	—	—	± 100	nA	V <sub>GS</sub> = ± 20V
	Gate-to-Source Reverse Leakage	N-P	—	—	± 100		V <sub>GS</sub> = ± 20V

**Dynamic Electrical Characteristics @ T<sub>J</sub> = 25°C (unless otherwise specified)**

Q <sub>g</sub>	Total Gate Charge	N-Ch	—	—	25	nC	N-Channel I <sub>D</sub> = 2.6A, V <sub>DS</sub> = 16V, V <sub>GS</sub> = 4.5V ③
		P-Ch	—	—	25		
Q <sub>gs</sub>	Gate-to-Source Charge	N-Ch	—	—	2.9	nC	P-Channel I <sub>D</sub> = -2.2A, V <sub>DS</sub> = -16V, V <sub>GS</sub> = -4.5V
		P-Ch	—	—	2.9		
Q <sub>gd</sub>	Gate-to-Drain Charge	N-Ch	—	—	7.9	nC	P-Channel I <sub>D</sub> = -2.2A, V <sub>DS</sub> = -16V, V <sub>GS</sub> = -4.5V
		P-Ch	—	—	9.0		
t <sub>d(on)</sub>	Turn-On Delay Time	N-Ch	—	6.8	—	ns	N-Channel V <sub>DD</sub> = 10V, I <sub>D</sub> = 2.6A, R <sub>G</sub> = 6.0Ω, R <sub>D</sub> = 3.8Ω
		P-Ch	—	11	—		
t <sub>r</sub>	Rise Time	N-Ch	—	21	—	ns	P-Channel V <sub>DD</sub> = -10V, I <sub>D</sub> = -2.2A, R <sub>G</sub> = 6.0Ω, R <sub>D</sub> = 4.5Ω
		P-Ch	—	17	—		
t <sub>d(off)</sub>	Turn-Off Delay Time	N-Ch	—	22	—	ns	P-Channel V <sub>DD</sub> = -10V, I <sub>D</sub> = -2.2A, R <sub>G</sub> = 6.0Ω, R <sub>D</sub> = 4.5Ω
		P-Ch	—	25	—		
t <sub>f</sub>	Fall Time	N-Ch	—	7.7	—	ns	P-Channel V <sub>DD</sub> = -10V, I <sub>D</sub> = -2.2A, R <sub>G</sub> = 6.0Ω, R <sub>D</sub> = 4.5Ω
		P-Ch	—	18	—		
L <sub>D</sub>	Internal Drain Inductance	N-P	—	4.0	—	nH	Between lead, 6mm(0.25n) from package and center of die contact
L <sub>S</sub>	Internal Source Inductance	N-P	—	6.0	—		
C <sub>iss</sub>	Input Capacitance	N-Ch	—	520	—	pF	N-Channel V <sub>GS</sub> = 0V, V <sub>DS</sub> = 15V, f = 1.0MHz ③
		P-Ch	—	440	—		
C <sub>oss</sub>	Output Capacitance	N-Ch	—	180	—	pF	P-Channel V <sub>GS</sub> = 0V, V <sub>DS</sub> = -15V, f = 1.0MHz ③
		P-Ch	—	200	—		
C <sub>rss</sub>	Reverse Transfer Capacitance	N-Ch	—	72	—	pF	P-Channel V <sub>GS</sub> = 0V, V <sub>DS</sub> = -15V, f = 1.0MHz ③
		P-Ch	—	93	—		

**Diode Characteristics**

	Parameter		Min.	Typ.	Max.	Units	Conditions
I <sub>S</sub>	Continuous Source Current (Body Diode)	N-Ch	—	—	1.8	A	
		P-Ch	—	—	-1.8		
I <sub>SM</sub>	Pulsed Source Current (Body Diode) ①	N-Ch	—	—	16	A	
		P-Ch	—	—	-12		
V <sub>SD</sub>	Diode Forward Voltage	N-Ch	—	—	1.0	V	T <sub>J</sub> = 25°C, I <sub>S</sub> = 1.8A, V <sub>GS</sub> = 0V ③
		P-Ch	—	—	-1.0		T <sub>J</sub> = 25°C, I <sub>S</sub> = -1.8A, V <sub>GS</sub> = 0V ③
t <sub>rr</sub>	Reverse Recovery Time	N-Ch	—	47	71	ns	N-Channel T <sub>J</sub> = 25°C, I <sub>F</sub> = 2.6A, di/dt = 100A/μs ③
		P-Ch	—	53	80		
Q <sub>rr</sub>	Reverse Recovery Charge	N-Ch	—	56	84	nC	P-Channel T <sub>J</sub> = 25°C, I <sub>F</sub> = -2.2A, di/dt = 100A/μs ③
		P-Ch	—	66	99		
t <sub>on</sub>	Forward Turn-On Time	Intrinsic turn-on time is negligible (turn-on is dominated by L <sub>S</sub> +L <sub>D</sub> )					

**Notes:**

- ① Repetitive rating; pulse width limited by max. junction temperature. (See Fig. 23)
- ② N-Channel I<sub>SD</sub> ≤ 2.4A, di/dt ≤ 73A/μs, V<sub>DD</sub> ≤ V<sub>(BR)DSS</sub>, T<sub>J</sub> ≤ 150°C.  
P-Channel I<sub>SD</sub> ≤ -1.8A, di/dt ≤ 90A/μs, V<sub>DD</sub> ≤ V<sub>(BR)DSS</sub>, T<sub>J</sub> ≤ 150°C
- ③ Pulse width ≤ 300μs; duty cycle ≤ 2%.
- ④ When mounted on 1" square PCB (FR-4 or G-10 Material). For recommended footprint and soldering techniques refer to application note #AN-994

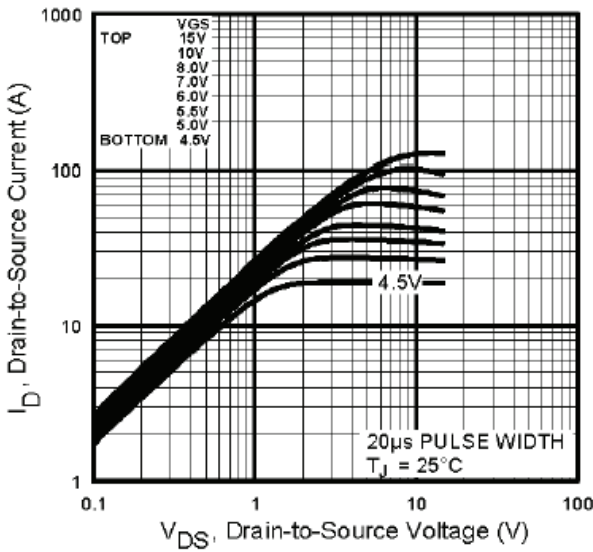

**Fig. 1** Typical Output Characteristics  
 $T_J = 25^\circ\text{C}$

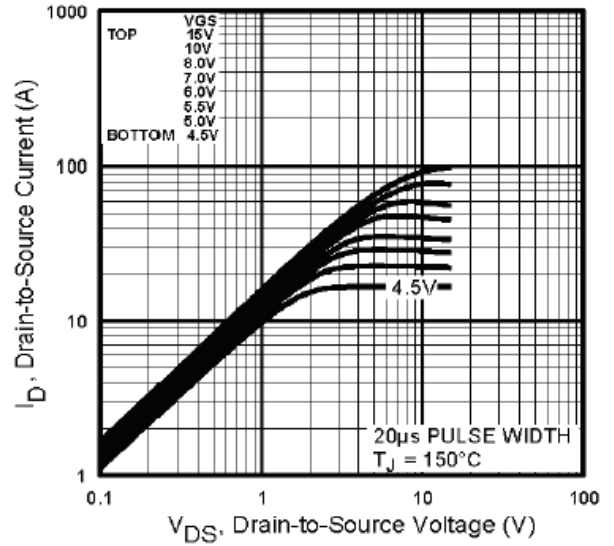

**Fig. 2** Typical Output Characteristics  
 $T_J = 150^\circ\text{C}$

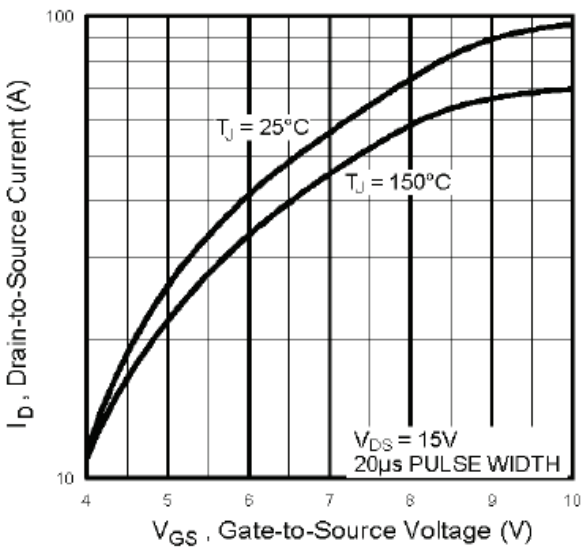

**Fig. 3** Typical Transfer Characteristics

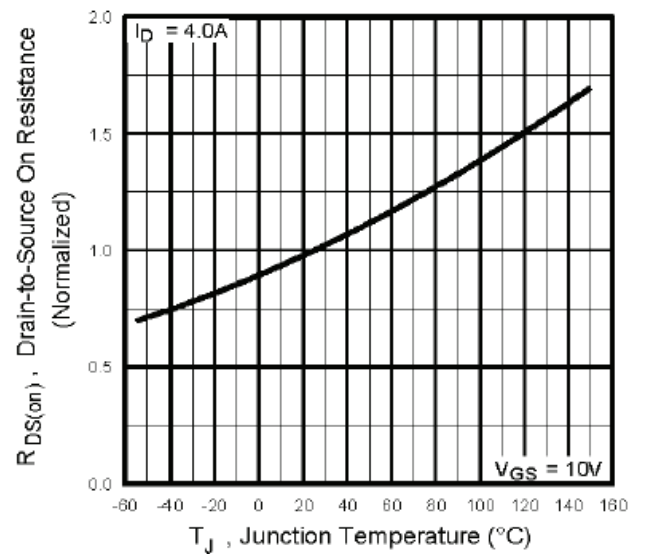

**Fig. 4** Normalized On-Resistance  
vs. Temperature

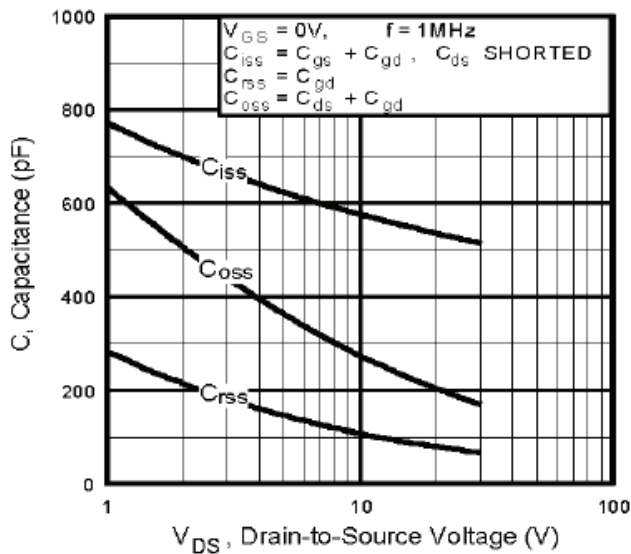

**Fig 5.** Typical Capacitance vs. Drain-to-Source Voltage

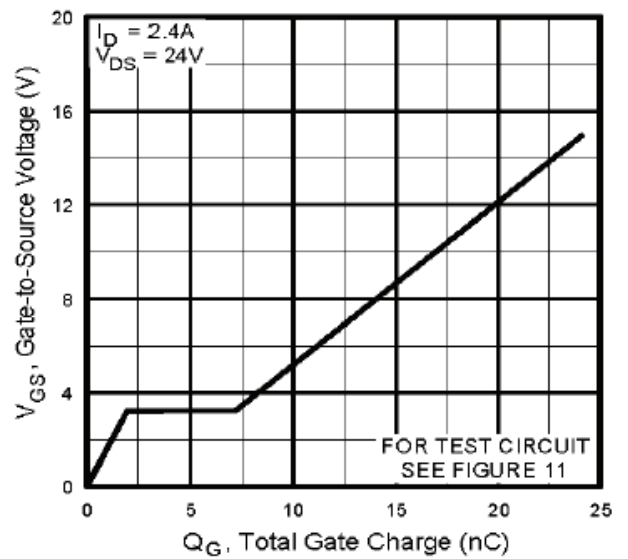

**Fig 6.** Typical Gate Charge vs. Gate-to-Source Voltage

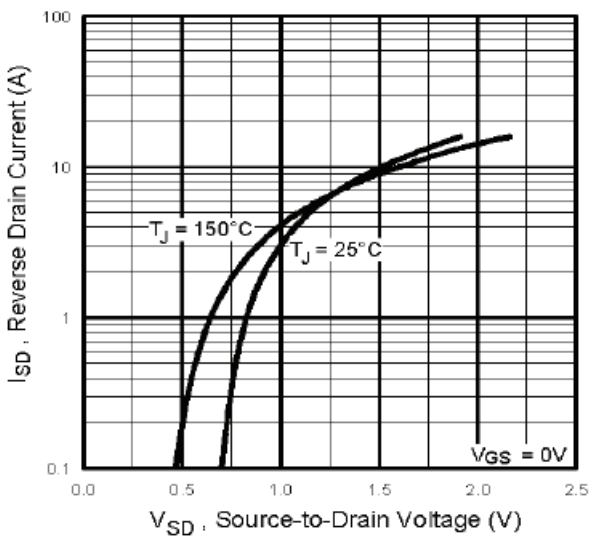

**Fig. 7** Typical Source-to-Drain Diode Forward Voltage

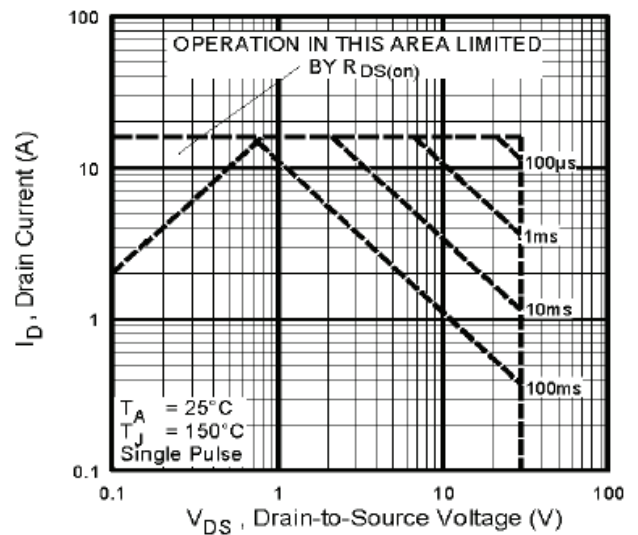

**Fig 8.** Maximum Safe Operating Area

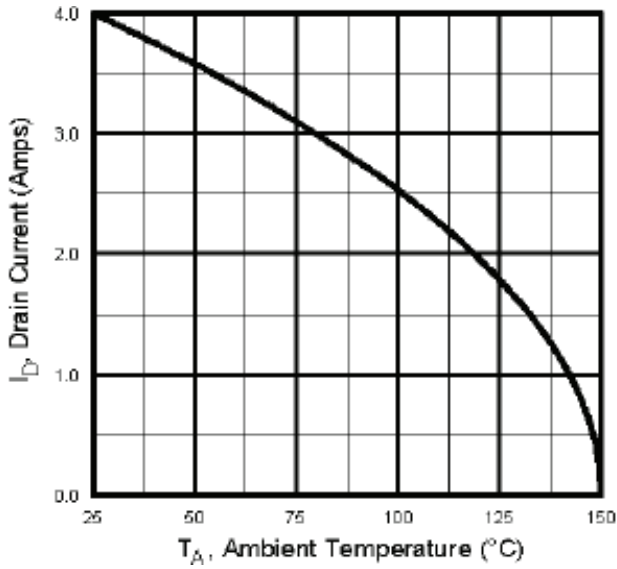

Fig 9. Maximum Drain Current vs. Case Temperature

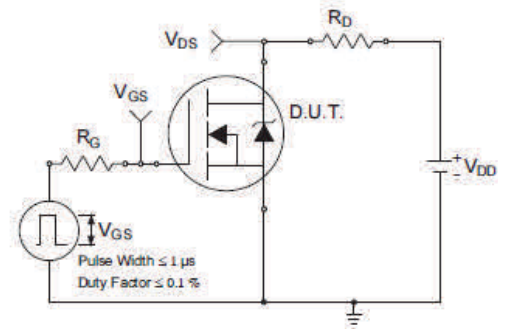

Fig 10a. Switching Time Test Circuit

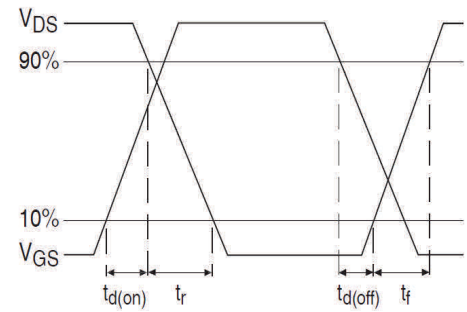

Fig 10b. Switching Time Waveforms

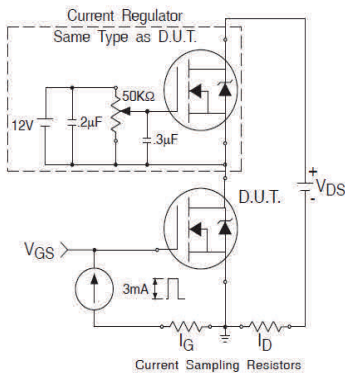

Fig 11a. Gate Charge Test Circuit

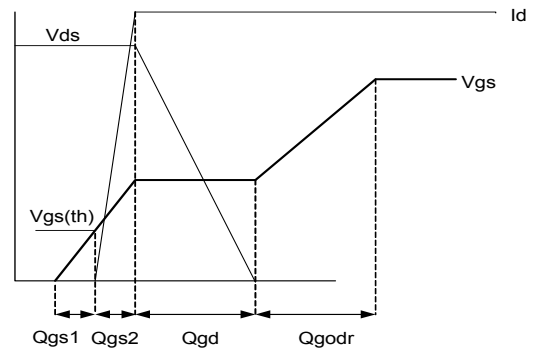
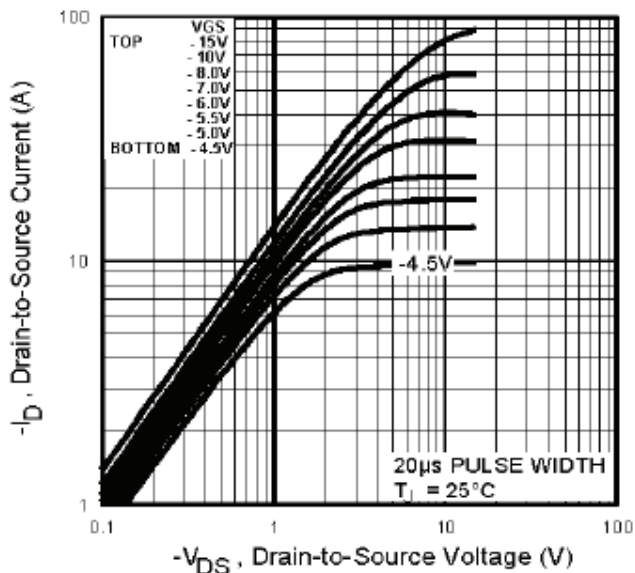
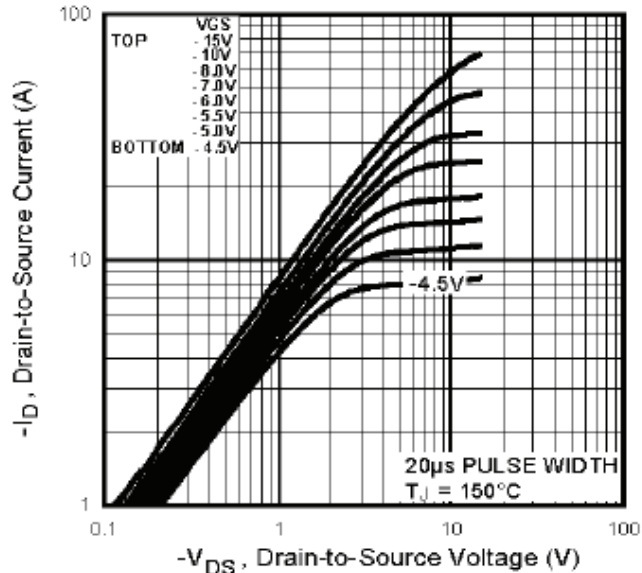

Fig 11b. Basic Gate Charge Waveform



**Fig. 12** Typical Output Characteristics  
 $T_J = 25^\circ\text{C}$



**Fig. 13** Typical Output Characteristics  
 $T_J = 150^\circ\text{C}$

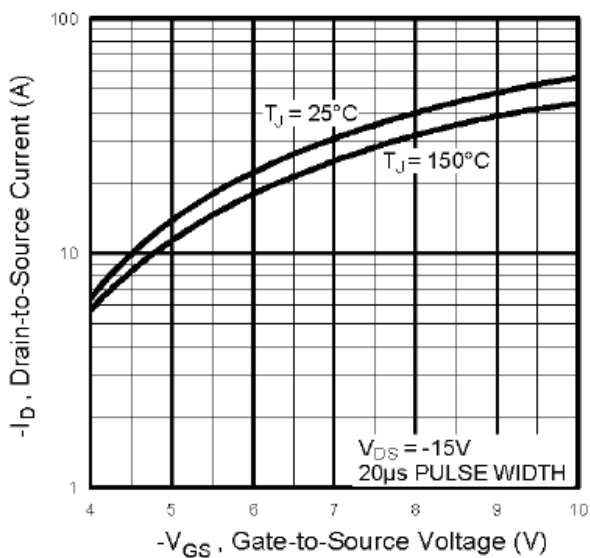

**Fig. 14** Typical Transfer Characteristics

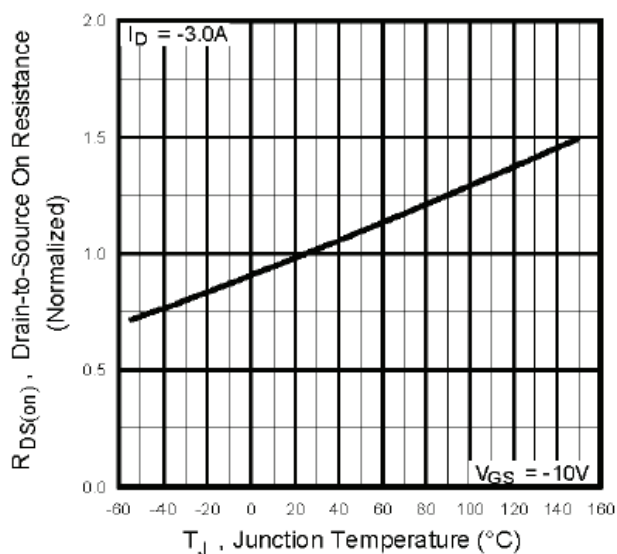

**Fig. 15** Normalized On-Resistance vs. Temperature

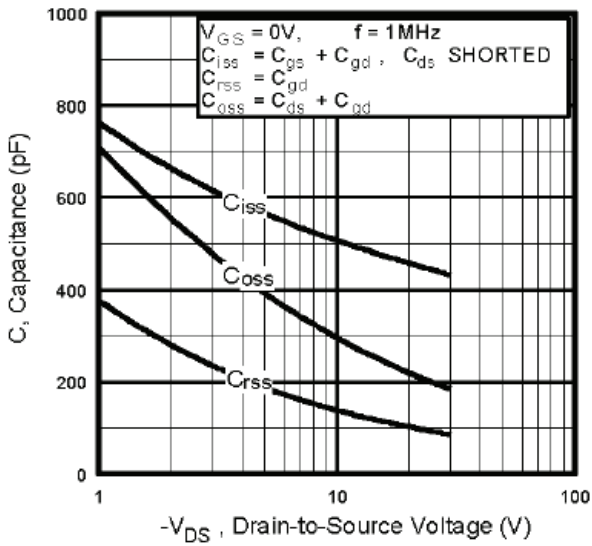

Fig 16. Typical Capacitance vs. Drain-to-Source Voltage

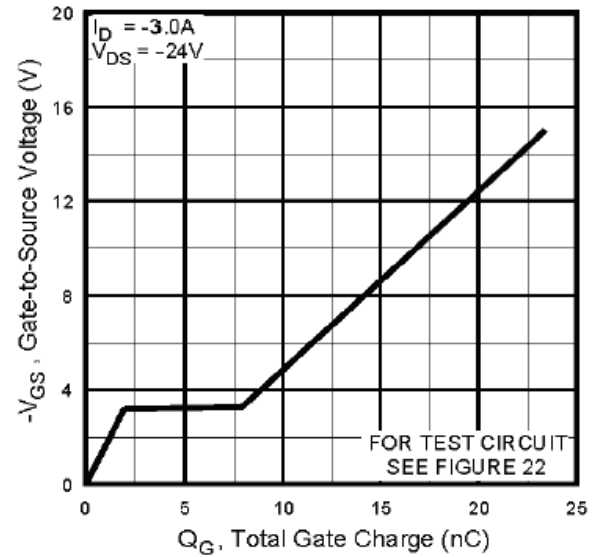

Fig 17. Typical Gate Charge vs. Gate-to-Source Voltage

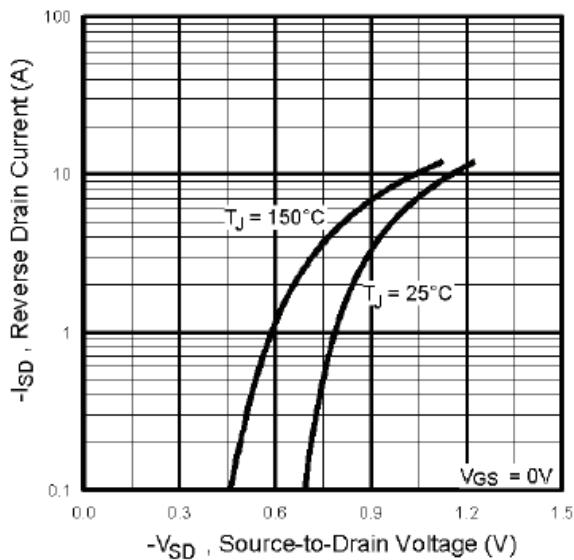

Fig 18 Typical Source-to-Drain Diode Forward Voltage

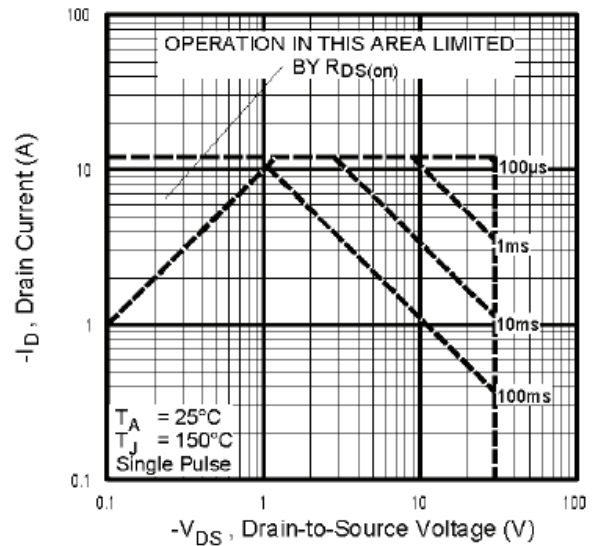

Fig 19. Maximum Safe Operating Area

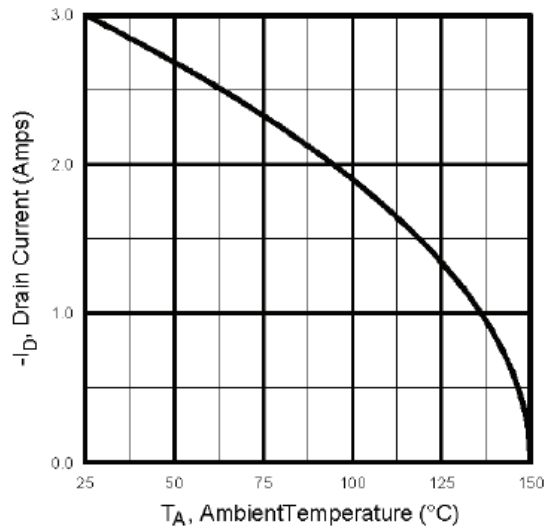

Fig 20. Maximum Drain Current vs. Case Temperature

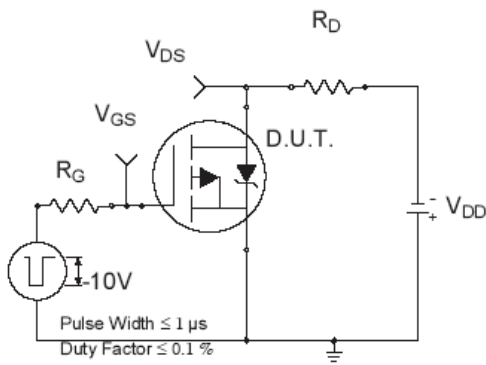

Fig 21a. Switching Time Test Circuit

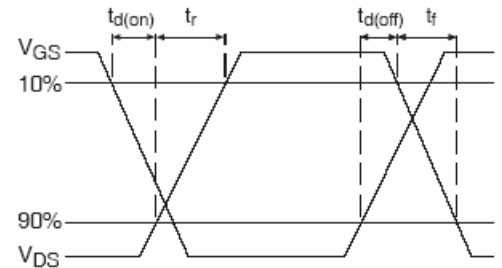

Fig 21b. Switching Time Waveforms

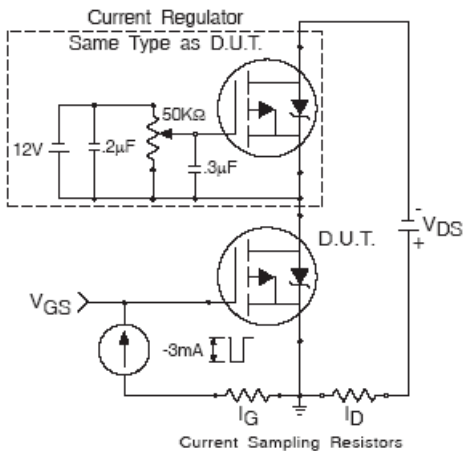

Fig 22a. Gate Charge Test Circuit

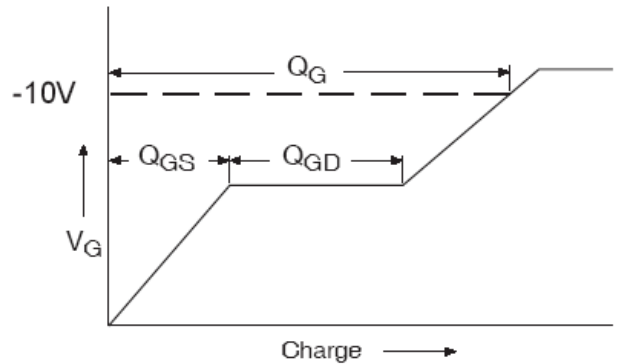

Fig 22b. Basic Gate Charge Waveform



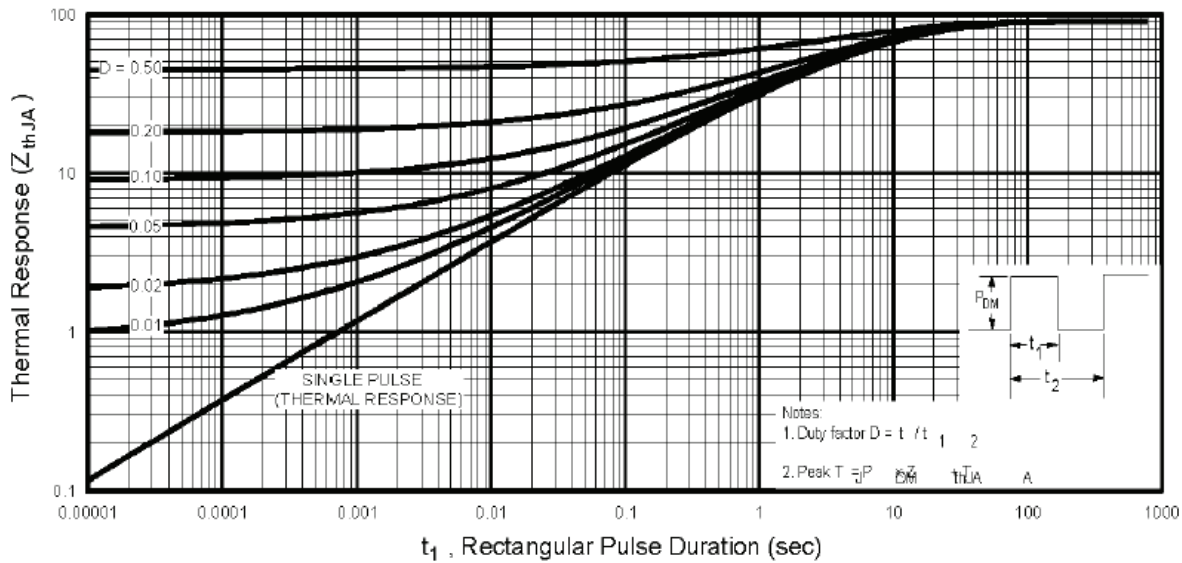

Fig 23. Maximum Effective Transient Thermal Impedance, Junction-to-Ambient

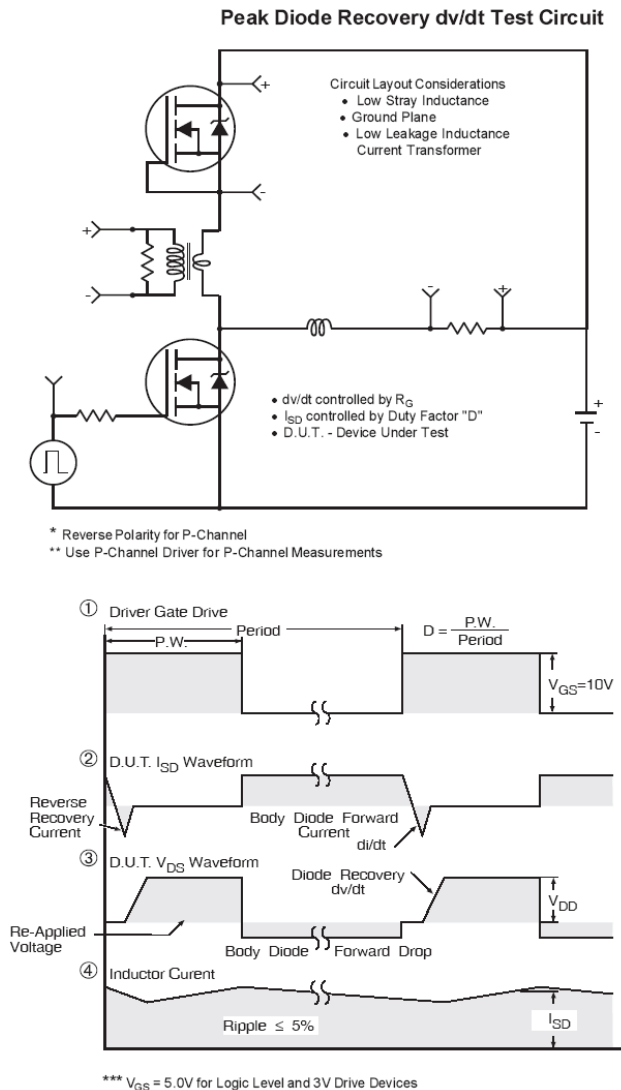
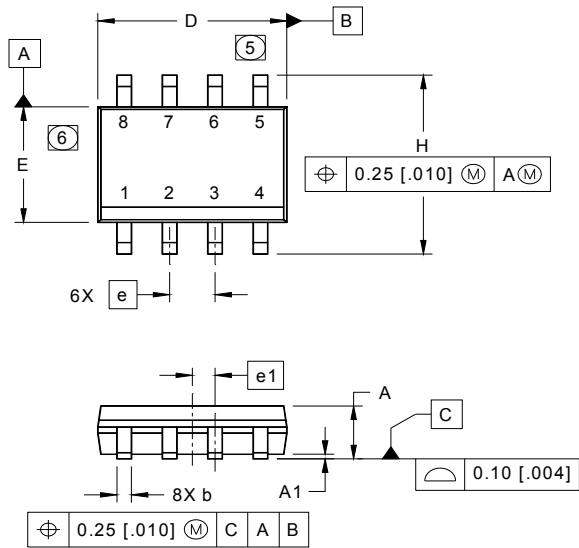
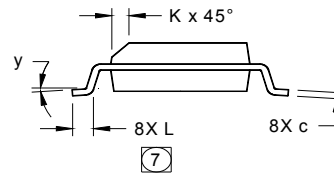

Fig 24. Peak Diode Recovery dv/dt Test Circuit for N & P-Channel HEXFET<sup>®</sup> Power MOSFETs

## SO-8 Package Outline (Dimensions are shown in millimeters (inches))



DIM	INCHES		MILLIMETERS	
	MIN	MAX	MIN	MAX
A	.0532	.0688	1.35	1.75
A1	.0040	.0098	0.10	0.25
b	.013	.020	0.33	0.51
c	.0075	.0098	0.19	0.25
D	.189	.1968	4.80	5.00
E	.1497	.1574	3.80	4.00
e	.050 BASIC		1.27 BASIC	
e 1	.025 BASIC		0.635 BASIC	
H	.2284	.2440	5.80	6.20
K	.0099	.0196	0.25	0.50
L	.016	.050	0.40	1.27
y	0°	8°	0°	8°



- NOTES:**
1. DIMENSIONING & TOLERANCING PER ASME Y14.5M -1994.
  2. CONTROLLING DIMENSION: MILLIMETER
  3. DIMENSIONS ARE SHOWN IN MILLIMETERS [INCHES].
  4. OUTLINE CONFORMS TO JEDEC OUTLINE MS-012AA.
  5. DIMENSION DOES NOT INCLUDE MOLD PROTRUSIONS. MOLD PROTRUSIONS NOT TO EXCEED 0.15 [0.006].
  6. DIMENSION DOES NOT INCLUDE MOLD PROTRUSIONS. MOLD PROTRUSIONS NOT TO EXCEED 0.25 [0.010].
  7. DIMENSION IS THE LENGTH OF LEAD FOR SOLDERING TO A SUBSTRATE.

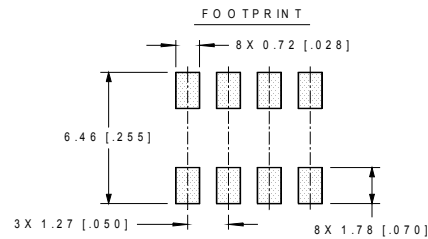

## SO-8 Part Marking Information

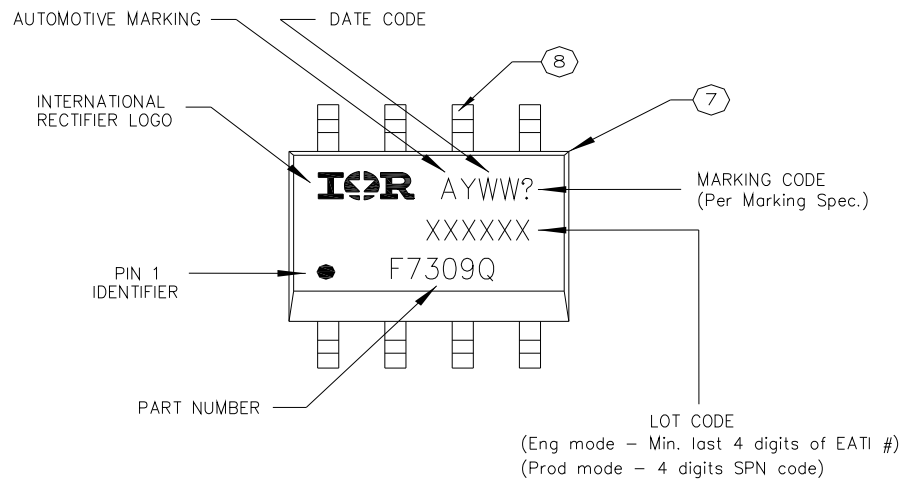

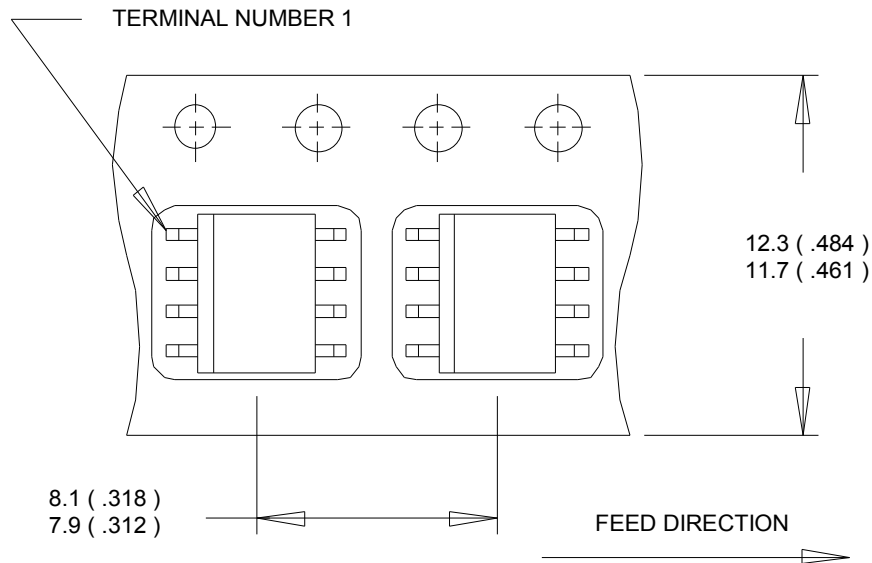
**SO-8 Tape and Reel** (Dimensions are shown in millimeters (inches))

**NOTES:**

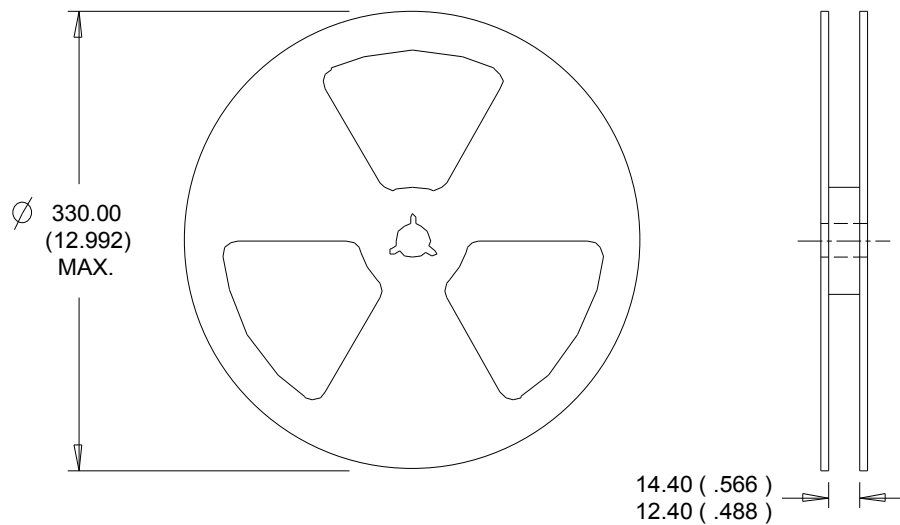
1. CONTROLLING DIMENSION : MILLIMETER.
2. ALL DIMENSIONS ARE SHOWN IN MILLIMETERS(INCHES).
3. OUTLINE CONFORMS TO EIA-481 & EIA-541.

**NOTES :**

1. CONTROLLING DIMENSION : MILLIMETER.
2. OUTLINE CONFORMS TO EIA-481 & EIA-541.

**Qualification Information**

<b>Qualification Level</b>		Automotive (per AEC-Q101)	
		Comments: This part number(s) passed Automotive qualification. Infineon's Industrial and Consumer qualification level is granted by extension of the higher Automotive level.	
<b>Moisture Sensitivity Level</b>		SO-8	MSL1
<b>ESD</b>	Machine Model	N CH: Class M2 (+/- 150V) <sup>†</sup> P CH: Class M2(+/- 150V) <sup>†</sup> AEC-Q101-002	
	Human Body Model	N CH: Class H1A (+/- 500V) <sup>†</sup> P CH: Class H0 (+/- 250V) <sup>†</sup> AEC-Q101-001	
	Charged Device Model	N CH: Class C5 (+/- 2000V) <sup>†</sup> P CH: Class C5 (+/- 2000V) <sup>†</sup> AEC-Q101-005	
<b>RoHS Compliant</b>		Yes	

† Highest passing voltage.

**Revision History**

Date	Comments
3/28/2014	<ul style="list-style-type: none"> <li>Added "Logic Level Gate Drive" bullet in the features section on page 1</li> <li>Updated data sheet with new IR corporate template</li> </ul>
9/30/2015	<ul style="list-style-type: none"> <li>Updated datasheet with corporate template</li> <li>Corrected ordering table on page 1.</li> </ul>

**Published by**

**Infineon Technologies AG**  
81726 München, Germany

© Infineon Technologies AG 2015

All Rights Reserved.

**IMPORTANT NOTICE**

The information given in this document shall in no event be regarded as a guarantee of conditions or characteristics ("Beschaffheitsgarantie"). With respect to any examples, hints or any typical values stated herein and/or any information regarding the application of the product, Infineon Technologies hereby disclaims any and all warranties and liabilities of any kind, including without limitation warranties of non-infringement of intellectual property rights of any third party.

In addition, any information given in this document is subject to customer's compliance with its obligations stated in this document and any applicable legal requirements, norms and standards concerning customer's products and any use of the product of Infineon Technologies in customer's applications.

The data contained in this document is exclusively intended for technically trained staff. It is the responsibility of customer's technical departments to evaluate the suitability of the product for the intended application and the completeness of the product information given in this document with respect to such application.

For further information on the product, technology, delivery terms and conditions and prices please contact your nearest Infineon Technologies office ([www.infineon.com](http://www.infineon.com)).

**WARNINGS**

Due to technical requirements products may contain dangerous substances. For information on the types in question please contact your nearest Infineon Technologies office.

Except as otherwise explicitly approved by Infineon Technologies in a written document signed by authorized representatives of Infineon Technologies, Infineon Technologies' products may not be used in any applications where a failure of the product or any consequences of the use thereof can reasonably be expected to result in personal injury.



Компания «ЭлектроПласт» предлагает заключение долгосрочных отношений при поставках импортных электронных компонентов на взаимовыгодных условиях!

Наши преимущества:

- Оперативные поставки широкого спектра электронных компонентов отечественного и импортного производства напрямую от производителей и с крупнейших мировых складов;
- Поставка более 17-ти миллионов наименований электронных компонентов;
- Поставка сложных, дефицитных, либо снятых с производства позиций;
- Оперативные сроки поставки под заказ (от 5 рабочих дней);
- Экспресс доставка в любую точку России;
- Техническая поддержка проекта, помощь в подборе аналогов, поставка прототипов;
- Система менеджмента качества сертифицирована по Международному стандарту ISO 9001;
- Лицензия ФСБ на осуществление работ с использованием сведений, составляющих государственную тайну;
- Поставка специализированных компонентов (Xilinx, Altera, Analog Devices, Intersil, Interpoint, Microsemi, Aeroflex, Peregrine, Syfer, Eurofarad, Texas Instrument, Miteq, Cobham, E2V, MA-COM, Hittite, Mini-Circuits, General Dynamics и др.);

Помимо этого, одним из направлений компании «ЭлектроПласт» является направление «Источники питания». Мы предлагаем Вам помощь Конструкторского отдела:

- Подбор оптимального решения, техническое обоснование при выборе компонента;
- Подбор аналогов;
- Консультации по применению компонента;
- Поставка образцов и прототипов;
- Техническая поддержка проекта;
- Защита от снятия компонента с производства.



#### Как с нами связаться

**Телефон:** 8 (812) 309 58 32 (многоканальный)

**Факс:** 8 (812) 320-02-42

**Электронная почта:** [org@eplast1.ru](mailto:org@eplast1.ru)

**Адрес:** 198099, г. Санкт-Петербург, ул. Калинина, дом 2, корпус 4, литера А.