

Features

- Dual P-Channel MOSFET
- Low On-Resistance
 - 150 mΩ @ $V_{GS} = -4.5V$
 - 200 mΩ @ $V_{GS} = -2.5V$
 - 240 mΩ @ $V_{GS} = -1.8V$
- Very Low Gate Threshold Voltage $V_{GS(th)} \leq 1V$
- Low Input Capacitance
- Fast Switching Speed
- Low Input/Output Leakage
- **Lead Free By Design/RoHS Compliant (Note 2)**
- **"Green" Device (Note 3)**
- **Qualified to AEC-Q101 standards for High Reliability**

Mechanical Data

- Case: SOT-26
- Case Material: Molded Plastic, "Green" Molding Compound. UL Flammability Classification Rating 94V-0
- Moisture Sensitivity: Level 1 per J-STD-020
- Terminals Connections: See Diagram
- Terminals: Finish — Matte Tin annealed over Copper leadframe. Solderable per MIL-STD-202, Method 208
- Marking Information: See Page 4
- Ordering Information: See Page 4
- Weight: 0.015 grams (approximate)

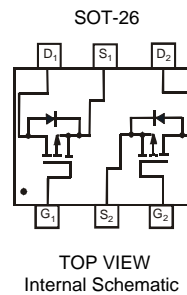
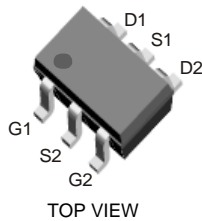

Maximum Ratings @ $T_A = 25^\circ C$ unless otherwise specified

Characteristic	Symbol	Value	Units
Drain-Source Voltage	V_{DSS}	-20	V
Gate-Source Voltage	V_{GSS}	± 12	V
Drain Current (Note 1)	I_D	-2.0 -1.5	A
Pulsed Drain Current	I_{DM}	-7	A

Thermal Characteristics

Characteristic	Symbol	Value	Units
Total Power Dissipation (Note 1)	P_D	600	mW
Thermal Resistance, Junction to Ambient	$R_{\theta JA}$	208	$^\circ C/W$
Operating and Storage Temperature Range	T_J, T_{STG}	-65 to +150	$^\circ C$

- Notes:
1. Device mounted on FR-4 PCB.
 2. No purposefully added lead.
 3. Diodes Inc.'s "Green" policy can be found on our website at http://www.diodes.com/products/lead_free/index.php.

Electrical Characteristics @ $T_A = 25^\circ\text{C}$ unless otherwise specified

Characteristic	Symbol	Min	Typ	Max	Unit	Test Condition
OFF CHARACTERISTICS (Note 4)						
Drain-Source Breakdown Voltage	BV_{DSS}	-20	—	—	V	$V_{GS} = 0V, I_D = -250\mu A$
Zero Gate Voltage Drain Current	I_{DSS}	—	—	-1.0 -5.0	μA	$T_J = 25^\circ\text{C}$ $T_J = 125^\circ\text{C}$ $V_{DS} = -20V, V_{GS} = 0V$
Gate-Source Leakage	I_{GSS}	—	—	± 100	nA	$V_{GS} = \pm 12V, V_{DS} = 0V$
ON CHARACTERISTICS (Note 4)						
Gate Threshold Voltage	$V_{GS(th)}$	-0.45	—	-1.0	V	$V_{DS} = V_{GS}, I_D = -250\mu A$
Static Drain-Source On-Resistance	$R_{DS(on)}$	—	92 134 180	150 200 240	m Ω	$V_{GS} = -4.5V, I_D = -2.0A$ $V_{GS} = -2.5V, I_D = -1.5A$ $V_{GS} = -1.8V, I_D = -0.5A$
Forward Transconductance	g_{FS}	—	3.1	—	S	$V_{DS} = -10V, I_D = -810mA$
Diode Forward Voltage (Note 4)	V_{SD}	—	—	-0.9	V	$V_{GS} = 0V, I_S = -0.5A$
DYNAMIC CHARACTERISTICS						
Input Capacitance	C_{iss}	—	320	—	pF	$V_{DS} = -16V, V_{GS} = 0V$ $f = 1.0MHz$
Output Capacitance	C_{oss}	—	80	—	pF	
Reverse Transfer Capacitance	C_{rss}	—	60	—	pF	
Turn-On Delay Time	$t_{D(on)}$	—	11.51	—	ns	$V_{DS} = -10V, V_{GS} = -4.5V$ $R_G = 6\Omega, R_L = 10\Omega$
Turn-On Rise Time	t_r	—	12.09	—	ns	
Turn-Off Delay Time	$t_{D(off)}$	—	55.34	—	ns	
Turn-Off Fall Time	t_f	—	27.54	—	ns	

Notes: 4. Short duration pulse test used to minimize self-heating effect.

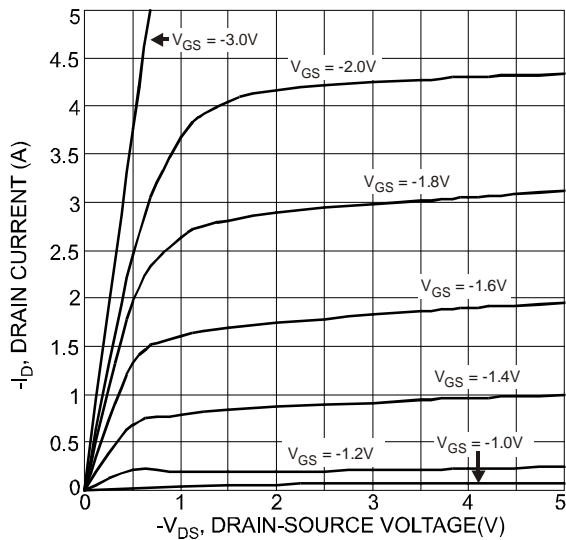

Fig.1 Typical Output Characteristics

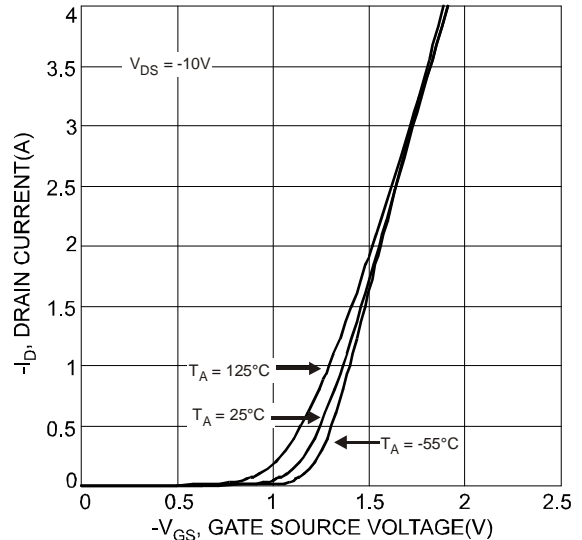

Fig. 2 Typical Transfer Characteristics

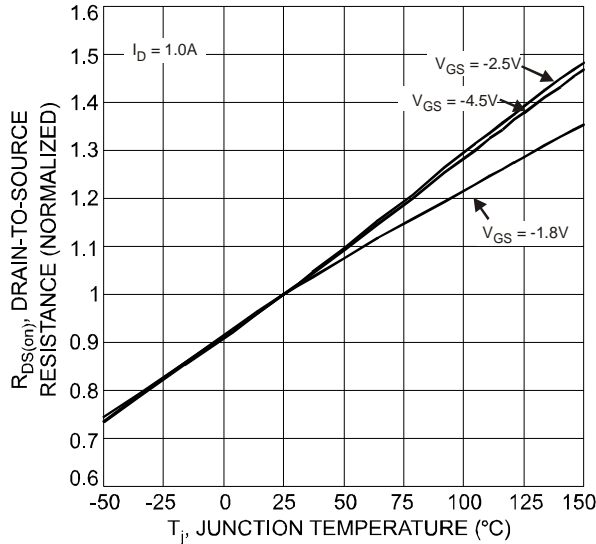

Fig. 3 On-Resistance Variation with Temperature

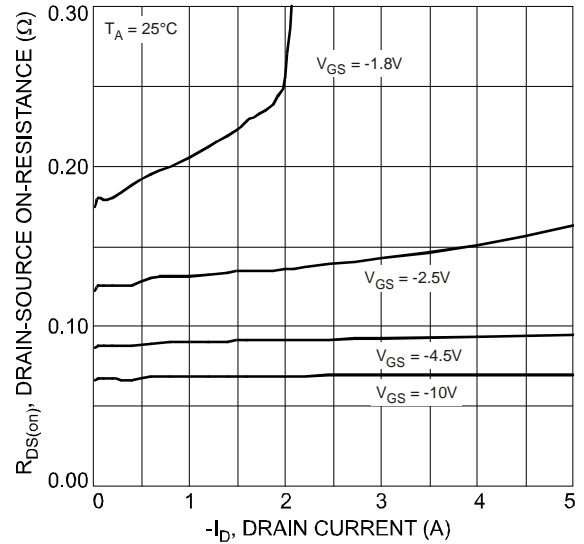

Fig. 4 On-Resistance vs Drain Current and Gate Voltage

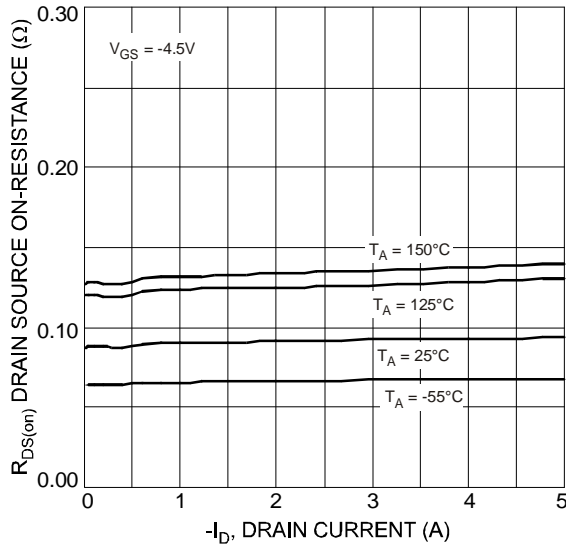

Fig. 5 Drain-Source On-Resistance Vs. Drain Current and Temperature

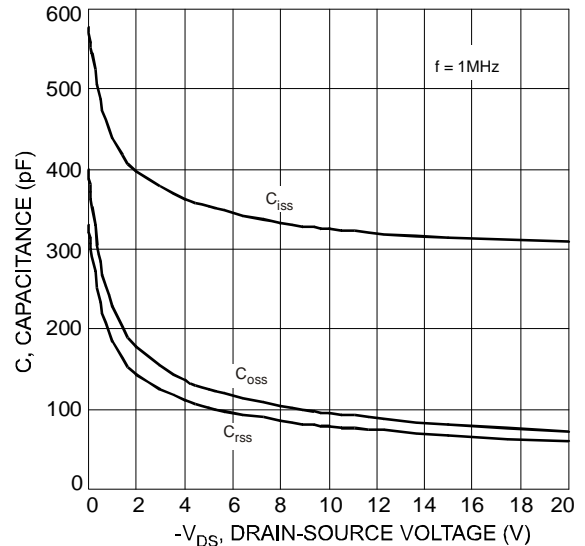

Fig. 6: Typical Capacitance

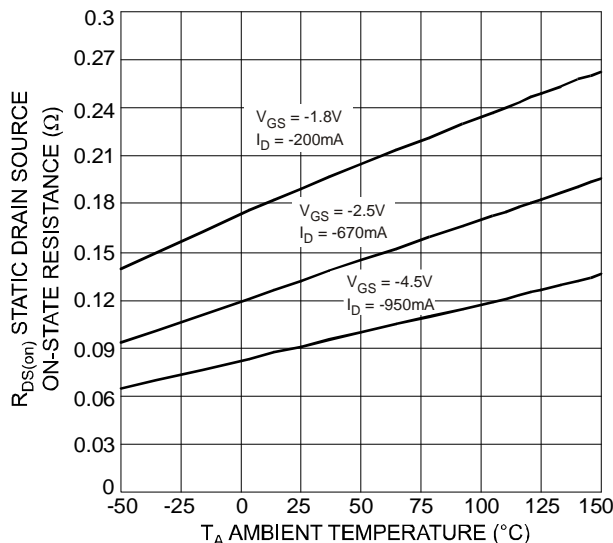

Fig. 7 Static Drain-Source On-State Resistance vs Ambient Temperature

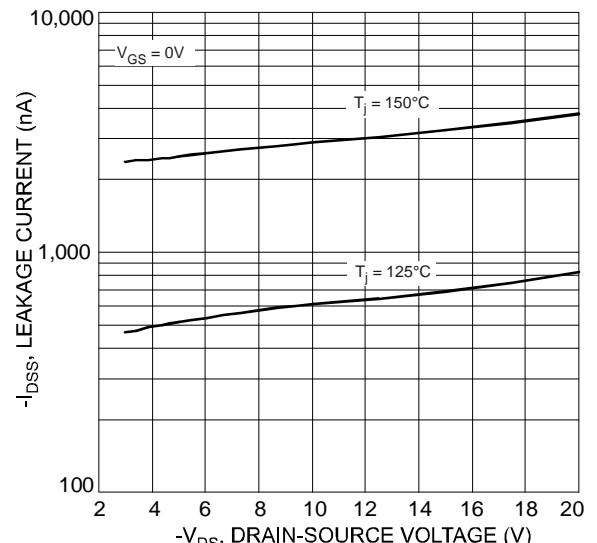

Fig. 8 Drain-Source Leakage Current vs Voltage

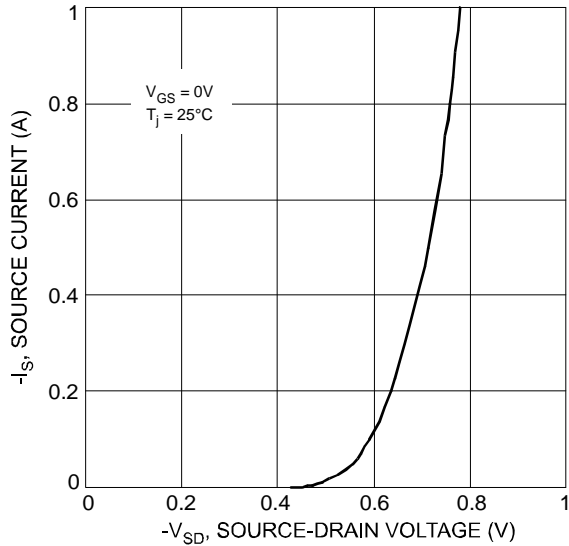

Fig. 9 Diode Forward Voltage vs. Current

Ordering Information (Note 5)

Part Number	Case	Packaging
DMP2240UDM-7	SOT-26	3000/Tape & Reel

Notes: 5. For packaging details, go to our website at <http://www.diodes.com/datasheets/ap02007.pdf>.

Marking Information

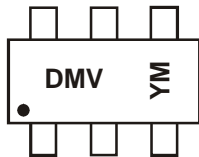

DMV = Marking Code
 YM = Date Code Marking
 Y = Year (ex: U = 2007)
 M = Month (ex: 9 = September)

Date Code Key

Year	2007	2008	2009	2010	2011	2012
Code	U	V	W	X	Y	Z

Month	Jan	Feb	Mar	Apr	May	Jun	Jul	Aug	Sep	Oct	Nov	Dec
Code	1	2	3	4	5	6	7	8	9	O	N	D

Package Outline Dimensions

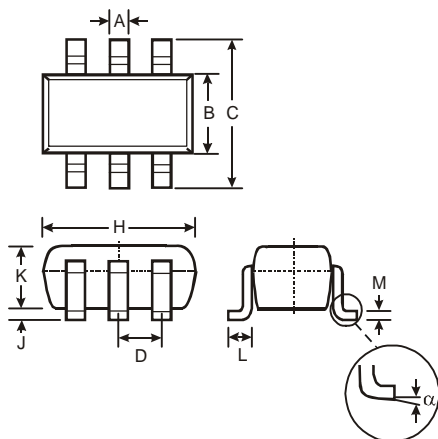

SOT-26			
Dim	Min	Max	Typ
A	0.35	0.50	0.38
B	1.50	1.70	1.60
C	2.70	3.00	2.80
D	—	—	0.95
H	2.90	3.10	3.00
J	0.013	0.10	0.05
K	1.00	1.30	1.10
L	0.35	0.55	0.40
M	0.10	0.20	0.15
α	0°	8°	—

All Dimensions in mm

Suggested Pad Layout

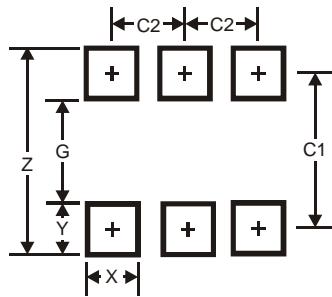

Dimensions	Value (in mm)
Z	3.20
G	1.60
X	0.55
Y	0.80
C1	2.40
C2	0.95

IMPORTANT NOTICE

DIODES INCORPORATED MAKES NO WARRANTY OF ANY KIND, EXPRESS OR IMPLIED, WITH REGARDS TO THIS DOCUMENT, INCLUDING, BUT NOT LIMITED TO, THE IMPLIED WARRANTIES OF MERCHANTABILITY AND FITNESS FOR A PARTICULAR PURPOSE (AND THEIR EQUIVALENTS UNDER THE LAWS OF ANY JURISDICTION).

Diodes Incorporated and its subsidiaries reserve the right to make modifications, enhancements, improvements, corrections or other changes without further notice to this document and any product described herein. Diodes Incorporated does not assume any liability arising out of the application or use of this document or any product described herein; neither does Diodes Incorporated convey any license under its patent or trademark rights, nor the rights of others. Any Customer or user of this document or products described herein in such applications shall assume all risks of such use and will agree to hold Diodes Incorporated and all the companies whose products are represented on Diodes Incorporated website, harmless against all damages.

Diodes Incorporated does not warrant or accept any liability whatsoever in respect of any products purchased through unauthorized sales channel. Should Customers purchase or use Diodes Incorporated products for any unintended or unauthorized application, Customers shall indemnify and hold Diodes Incorporated and its representatives harmless against all claims, damages, expenses, and attorney fees arising out of, directly or indirectly, any claim of personal injury or death associated with such unintended or unauthorized application.

Products described herein may be covered by one or more United States, international or foreign patents pending. Product names and markings noted herein may also be covered by one or more United States, international or foreign trademarks.

LIFE SUPPORT

Diodes Incorporated products are specifically not authorized for use as critical components in life support devices or systems without the express written approval of the Chief Executive Officer of Diodes Incorporated. As used herein:

A. Life support devices or systems are devices or systems which:

1. are intended to implant into the body, or
2. support or sustain life and whose failure to perform when properly used in accordance with instructions for use provided in the labeling can be reasonably expected to result in significant injury to the user.

B. A critical component is any component in a life support device or system whose failure to perform can be reasonably expected to cause the failure of the life support device or to affect its safety or effectiveness.

Customers represent that they have all necessary expertise in the safety and regulatory ramifications of their life support devices or systems, and acknowledge and agree that they are solely responsible for all legal, regulatory and safety-related requirements concerning their products and any use of Diodes Incorporated products in such safety-critical, life support devices or systems, notwithstanding any devices- or systems-related information or support that may be provided by Diodes Incorporated. Further, Customers must fully indemnify Diodes Incorporated and its representatives against any damages arising out of the use of Diodes Incorporated products in such safety-critical, life support devices or systems.

Copyright © 2010, Diodes Incorporated

www.diodes.com



Компания «ЭлектроПласт» предлагает заключение долгосрочных отношений при поставках импортных электронных компонентов на взаимовыгодных условиях!

Наши преимущества:

- Оперативные поставки широкого спектра электронных компонентов отечественного и импортного производства напрямую от производителей и с крупнейших мировых складов;
- Поставка более 17-ти миллионов наименований электронных компонентов;
- Поставка сложных, дефицитных, либо снятых с производства позиций;
- Оперативные сроки поставки под заказ (от 5 рабочих дней);
- Экспресс доставка в любую точку России;
- Техническая поддержка проекта, помощь в подборе аналогов, поставка прототипов;
- Система менеджмента качества сертифицирована по Международному стандарту ISO 9001;
- Лицензия ФСБ на осуществление работ с использованием сведений, составляющих государственную тайну;
- Поставка специализированных компонентов (Xilinx, Altera, Analog Devices, Intersil, Interpoint, Microsemi, Aeroflex, Peregrine, Syfer, Eurofarad, Texas Instrument, Miteq, Cobham, E2V, MA-COM, Hittite, Mini-Circuits, General Dynamics и др.);

Помимо этого, одним из направлений компании «ЭлектроПласт» является направление «Источники питания». Мы предлагаем Вам помощь Конструкторского отдела:

- Подбор оптимального решения, техническое обоснование при выборе компонента;
- Подбор аналогов;
- Консультации по применению компонента;
- Поставка образцов и прототипов;
- Техническая поддержка проекта;
- Защита от снятия компонента с производства.



Как с нами связаться

Телефон: 8 (812) 309 58 32 (многоканальный)

Факс: 8 (812) 320-02-42

Электронная почта: org@eplast1.ru

Адрес: 198099, г. Санкт-Петербург, ул. Калинина, дом 2, корпус 4, литера А.