

FEATURES

- 100MHz Gain Bandwidth Product
- 750V/ μ s Slew Rate
- 3.6mA Maximum Supply Current per Amplifier
- Tiny 3mm x 3mm x 0.8mm DFN Package
- 8nV/ $\sqrt{\text{Hz}}$ Input Noise Voltage
- Unity-Gain Stable
- 1.5mV Maximum Input Offset Voltage
- 4 μ A Maximum Input Bias Current
- 400nA Maximum Input Offset Current
- 40mA Minimum Output Current, $V_{OUT} = \pm 3V$
- $\pm 3.5V$ Minimum Input CMR, $V_S = \pm 5V$
- 30ns Settling Time to 0.1%, 5V Step
- Specified at $\pm 5V$, Single 5V Supplies
- Operating Temperature Range: -40°C to 85°C

APPLICATIONS

- Active Filters
- Wideband Amplifiers
- Buffers
- Video Amplification
- Communication Receivers
- Cable Drivers
- Data Acquisition Systems

DESCRIPTION

The LT[®]1813/LT1814 are dual and quad, low power, high speed, very high slew rate operational amplifiers with excellent DC performance. The LT1813/LT1814 feature reduced supply current, lower input offset voltage, lower input bias current and higher DC gain than other devices with comparable bandwidth. The circuit topology is a voltage feedback amplifier with the slewing characteristics of a current feedback amplifier.

The output drives a 100 Ω load to $\pm 3.5V$ with $\pm 5V$ supplies. On a single 5V supply, the output swings from 1.1V to 3.9V with a 100 Ω load connected to 2.5V. The amplifiers are stable with a 1000pF capacitive load making them useful in buffer and cable driver applications.

The LT1813/LT1814 are manufactured on Linear Technology's advanced low voltage complementary bipolar process. The LT1813 dual op amp is available in 8-pin MSOP, SO and 3mm x 3mm low profile (0.8mm) dual fine pitch leadless packages (DFN). The quad LT1814 is available in 14-pin SO and 16-pin SSOP packages. A single version, the LT1812, is also available (see separate data sheet).

 LTC and LT are registered trademarks of Linear Technology Corporation.

TYPICAL APPLICATION

Bandpass Filter with Independently Settable Gain, Q and f_c

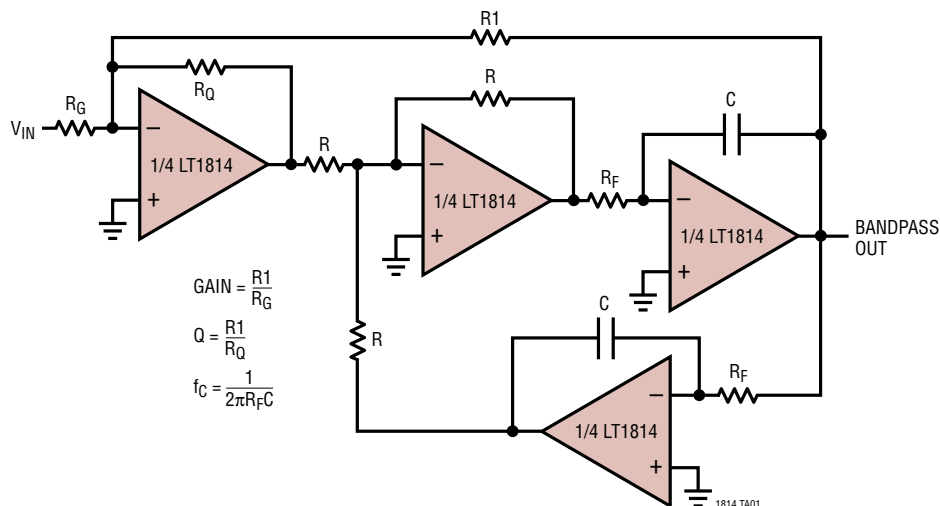

Filter Frequency Response

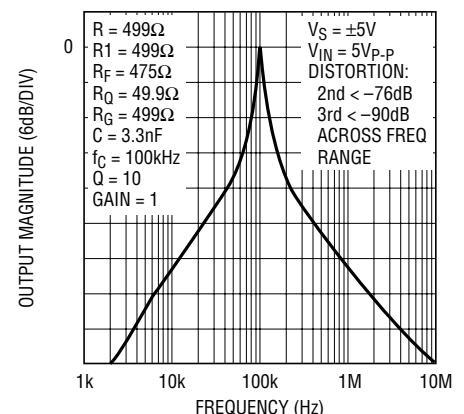

LT1813/LT1814

ABSOLUTE MAXIMUM RATINGS (Note 1)

Total Supply Voltage (V^+ to V^-)

LT1813/LT1814 12.6V

LT1813HV 13.5V

Differential Input Voltage (Transient Only, Note 2) .. $\pm 6V$

Input Voltage $\pm V_S$

Output Short-Circuit Duration (Note 3) Indefinite

Operating Temperature Range -40°C to 85°C

Specified Temperature Range (Note 8) .. -40°C to 85°C

Maximum Junction Temperature 150°C

(DD Package) 125°C

Storage Temperature Range -65°C to 150°C

(DD Package) -65°C to 125°C

Lead Temperature (Soldering, 10 sec) 300°C

PACKAGE/ORDER INFORMATION

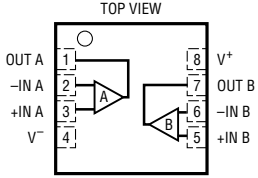
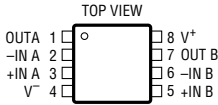
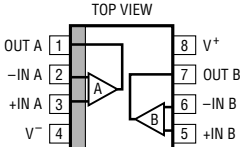
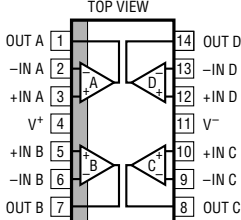
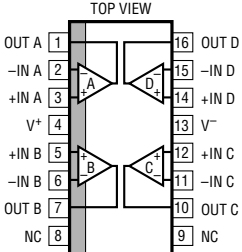
 <p>DD PACKAGE 8-LEAD (3mm x 3mm) PLASTIC DFN $T_{JMAX} = 125^\circ\text{C}$, $\theta_{JA} = 160^\circ\text{C/W}$ UNDERSIDE METAL INTERNALLY CONNECTED TO V^-</p>		<p>ORDER PART NUMBER</p> <p>LT1813DDD* LT1813CDD LT1813IDD</p> <p>DD PART MARKING **</p> <p>LAAQ</p>	 <p>MS8 PACKAGE 8-LEAD PLASTIC MSOP $T_{JMAX} = 150^\circ\text{C}$, $\theta_{JA} = 250^\circ\text{C/W}$</p>	<p>ORDER PART NUMBER</p> <p>LT1813DMS8*</p> <p>MS8 PART MARKING</p> <p>LTGZ</p>
 <p>S8 PACKAGE 8-LEAD PLASTIC SO $T_{JMAX} = 150^\circ\text{C}$, $\theta_{JA} = 150^\circ\text{C/W}$</p>		 <p>S PACKAGE 14-LEAD PLASTIC SO $T_{JMAX} = 150^\circ\text{C}$, $\theta_{JA} = 110^\circ\text{C/W}$</p>	 <p>GN PACKAGE 16-LEAD PLASTIC SSOP $T_{JMAX} = 150^\circ\text{C}$, $\theta_{JA} = 135^\circ\text{C/W}$</p>	
ORDER PART NUMBER	S8 PART MARKING	ORDER PART NUMBER	ORDER PART NUMBER	
LT1813DS8*	1813D	LT1814CS	LT1814CGN	
LT1813CS8	1813	LT1814IS	LT1814IGN	
LT1813IS8	1813I		GN PART MARKING	
LT1813HVD8*	813HVD		1814	
LT1813HVCS8	1813HV		1814I	
LT1813HVIS8	813HVI			

Consult LTC marketing for parts specified with wider operating temperature ranges. *See Note 9.

**The temperature grades are identified by a label on the shipping container.

ELECTRICAL CHARACTERISTICS The ● denotes the specifications which apply over the full operating temperature range, otherwise specifications are at $T_A = 25^\circ\text{C}$. $V_S = \pm 5\text{V}$, $V_{CM} = 0\text{V}$, unless otherwise noted. (Note 8)

SYMBOL	PARAMETER	CONDITIONS	MIN	TYP	MAX	UNITS
V_{OS}	Input Offset Voltage (Note 4)	$T_A = 0^\circ\text{C}$ to 70°C	●	0.5	1.5	mV
		$T_A = -40^\circ\text{C}$ to 85°C	●		2	mV
						3
$\frac{\Delta V_{OS}}{\Delta T}$	Input Offset Voltage Drift (Note 7)	$T_A = 0^\circ\text{C}$ to 70°C	●	10	15	$\mu\text{V}/^\circ\text{C}$
		$T_A = -40^\circ\text{C}$ to 85°C	●	10	30	$\mu\text{V}/^\circ\text{C}$
I_{OS}	Input Offset Current	$T_A = 0^\circ\text{C}$ to 70°C	●	50	400	nA
		$T_A = -40^\circ\text{C}$ to 85°C	●		500	nA
						600
I_B	Input Bias Current	$T_A = 0^\circ\text{C}$ to 70°C	●	-0.9	± 4	μA
		$T_A = -40^\circ\text{C}$ to 85°C	●		± 5	μA
					± 6	μA
e_n	Input Noise Voltage Density	$f = 10\text{kHz}$		8		$\text{nV}/\sqrt{\text{Hz}}$
i_n	Input Noise Current Density	$f = 10\text{kHz}$		1		$\text{pA}/\sqrt{\text{Hz}}$
R_{IN}	Input Resistance	$V_{CM} = 3.5\text{V}$ Differential		3	10	$\text{M}\Omega$
					1.5	$\text{M}\Omega$
C_{IN}	Input Capacitance			2		pF
V_{CM}	Input Voltage Range	Guaranteed by CMRR $T_A = -40^\circ\text{C}$ to 85°C	●	± 3.5	± 4.2	V
				± 3.5		V
CMRR	Common Mode Rejection Ratio	$V_{CM} = \pm 3.5\text{V}$ $T_A = 0^\circ\text{C}$ to 70°C $T_A = -40^\circ\text{C}$ to 85°C	●	75	85	dB
			●	73		dB
			●	72		dB
	Minimum Supply Voltage	Guaranteed by PSRR $T_A = -40^\circ\text{C}$ to 85°C	●	± 1.25	± 2	V
					± 2	V
PSRR	Power Supply Rejection Ratio	$V_S = \pm 2\text{V}$ to $\pm 5.5\text{V}$ $T_A = 0^\circ\text{C}$ to 70°C $T_A = -40^\circ\text{C}$ to 85°C	●	78	97	dB
			●	76		dB
			●	75		dB
		$V_S = \pm 2\text{V}$ to $\pm 6.5\text{V}$ (LT1813HV) $T_A = 0^\circ\text{C}$ to 70°C $T_A = -40^\circ\text{C}$ to 85°C	●	75	97	dB
			●	73		dB
			●	72		dB
A_{VOL}	Large-Signal Voltage Gain	$V_{OUT} = \pm 3\text{V}$, $R_L = 500\Omega$ $T_A = 0^\circ\text{C}$ to 70°C $T_A = -40^\circ\text{C}$ to 85°C	●	1.5	3	V/mV
			●	1.0		V/mV
			●	0.8		V/mV
		$V_{OUT} = \pm 3\text{V}$, $R_L = 100\Omega$ $T_A = 0^\circ\text{C}$ to 70°C $T_A = -40^\circ\text{C}$ to 85°C	●	1.0	2.5	V/mV
			●	0.7		V/mV
			●	0.6		V/mV
V_{OUT}	Maximum Output Swing (Positive/Negative)	$R_L = 500\Omega$, 30mV Overdrive $T_A = 0^\circ\text{C}$ to 70°C $T_A = -40^\circ\text{C}$ to 85°C	●	± 3.8	± 4	V
			●	± 3.7		V
			●	± 3.6		V
		$R_L = 100\Omega$, 30mV Overdrive $T_A = 0^\circ\text{C}$ to 70°C $T_A = -40^\circ\text{C}$ to 85°C	●	± 3.35	± 3.5	V
			●	± 3.25		V
			●	± 3.15		V

ELECTRICAL CHARACTERISTICS The ● denotes the specifications which apply over the full operating temperature range, otherwise specifications are at $T_A = 25^\circ\text{C}$. $V_S = \pm 5\text{V}$, $V_{CM} = 0\text{V}$, unless otherwise noted. (Note 8)

SYMBOL	PARAMETER	CONDITIONS	MIN	TYP	MAX	UNITS	
I_{OUT}	Maximum Output Current	$V_{OUT} = \pm 3\text{V}$, 30mV Overdrive		±40	±60	mA	
		$T_A = 0^\circ\text{C}$ to 70°C	●	±35			mA
		$T_A = -40^\circ\text{C}$ to 85°C	●	±30			
I_{SC}	Output Short-Circuit Current	$V_{OUT} = 0\text{V}$, 1V Overdrive (Note 3)		±75	±100	mA	
		$T_A = 0^\circ\text{C}$ to 70°C	●	±60			mA
		$T_A = -40^\circ\text{C}$ to 85°C	●	±55			
SR	Slew Rate	$A_V = -1$ (Note 5)		500	750	V/μs	
		$T_A = 0^\circ\text{C}$ to 70°C	●	400			V/μs
		$T_A = -40^\circ\text{C}$ to 85°C	●	350			
FPBW	Full Power Bandwidth	$6V_{P-P}$ (Note 6)		40		MHz	
GBW	Gain Bandwidth Product	$f = 200\text{kHz}$, $R_L = 500\Omega$		75	100	MHz	
		$T_A = 0^\circ\text{C}$ to 70°C	●	65			MHz
		$T_A = -40^\circ\text{C}$ to 85°C	●	60			
-3dB BW	-3dB Bandwidth	$A_V = 1$, $R_L = 500\Omega$		200		MHz	
t_r , t_f	Rise Time, Fall Time	$A_V = 1$, 10% to 90%, 0.1V, $R_L = 100\Omega$		2		ns	
t_{PD}	Propagation Delay (Note 10)	$A_V = 1$, 50% to 50%, 0.1V, $R_L = 100\Omega$		2.8		ns	
OS	Overshoot	$A_V = 1$, 0.1V, $R_L = 100\Omega$		25		%	
t_S	Settling Time	$A_V = -1$, 0.1%, 5V		30		ns	
THD	Total Harmonic Distortion	$A_V = 2$, $f = 1\text{MHz}$, $V_{OUT} = 2V_{P-P}$, $R_L = 500\Omega$		-76		dB	
dG	Differential Gain	$A_V = 2$, $V_{OUT} = 2V_{P-P}$, $R_L = 150\Omega$		0.12		%	
dP	Differential Phase	$A_V = 2$, $V_{OUT} = 2V_{P-P}$, $R_L = 150\Omega$		0.07		DEG	
R_{OUT}	Output Resistance	$A_V = 1$, $f = 1\text{MHz}$		0.4		Ω	
	Channel Separation	$V_{OUT} = \pm 3\text{V}$, $R_L = 100\Omega$		82	100	dB	
	$T_A = 0^\circ\text{C}$ to 70°C	●	81	dB			
	$T_A = -40^\circ\text{C}$ to 85°C	●	80				dB
I_S	Supply Current	Per Amplifier			3	3.6	
		$T_A = 0^\circ\text{C}$ to 70°C	●				4.5
		$T_A = -40^\circ\text{C}$ to 85°C	●				
		Per Amplifier, $V_S = \pm 6.5\text{V}$, (LT1813HV only)				4.0	mA
		$T_A = 0^\circ\text{C}$ to 70°C	●		5.0		
$T_A = -40^\circ\text{C}$ to 85°C	●		5.5				

ELECTRICAL CHARACTERISTICS The ● denotes the specifications which apply over the full operating temperature range, otherwise specifications are at $T_A = 25^\circ\text{C}$. $V_S = 5\text{V}$, $V_{CM} = 2.5\text{V}$, R_L to 2.5V, unless otherwise noted. (Note 8)

SYMBOL	PARAMETER	CONDITIONS	MIN	TYP	MAX	UNITS	
V_{OS}	Input Offset Voltage (Note 4)	$T_A = 0^\circ\text{C}$ to 70°C	●	0.7	2.0	mV	
		$T_A = -40^\circ\text{C}$ to 85°C	●		2.5	mV	
					3.5	mV	
$\frac{\Delta V_{OS}}{\Delta T}$	Input Offset Voltage Drift (Note 7)	$T_A = 0^\circ\text{C}$ to 70°C	●	10	15	$\mu\text{V}/^\circ\text{C}$	
		$T_A = -40^\circ\text{C}$ to 85°C	●	10	30	$\mu\text{V}/^\circ\text{C}$	
I_{OS}	Input Offset Current	$T_A = 0^\circ\text{C}$ to 70°C	●	50	400	nA	
		$T_A = -40^\circ\text{C}$ to 85°C	●		500	nA	
					600	nA	
I_B	Input Bias Current	$T_A = 0^\circ\text{C}$ to 70°C	●	-1	± 4	μA	
		$T_A = -40^\circ\text{C}$ to 85°C	●		± 5	μA	
					± 6	μA	
e_n	Input Noise Voltage Density	$f = 10\text{kHz}$		8		$\text{nV}/\sqrt{\text{Hz}}$	
i_n	Input Noise Current Density	$f = 10\text{kHz}$		1		$\text{pA}/\sqrt{\text{Hz}}$	
R_{IN}	Input Resistance	$V_{CM} = 3.5\text{V}$ Differential		3	10	$\text{M}\Omega$	
					1.5	$\text{M}\Omega$	
C_{IN}	Input Capacitance			2		pF	
V_{CM}	Input Voltage Range (Positive)	Guaranteed by CMRR $T_A = -40^\circ\text{C}$ to 85°C	●	3.5	4.2	V	
	Input Voltage Range (Negative)	Guaranteed by CMRR $T_A = -40^\circ\text{C}$ to 85°C	●	0.8	1.5	V	
CMRR	Common Mode Rejection Ratio	$V_{CM} = 1.5\text{V}$ to 3.5V	●	73	82	dB	
		$T_A = 0^\circ\text{C}$ to 70°C	●	71		dB	
		$T_A = -40^\circ\text{C}$ to 85°C	●	70		dB	
	Minimum Supply Voltage	Guaranteed by PSRR $T_A = -40^\circ\text{C}$ to 85°C	●	2.5	4	V	
					4	V	
A_{VOL}	Large-Signal Voltage Gain	$V_{OUT} = 1.5\text{V}$ to 3.5V , $R_L = 500\Omega$	$T_A = 0^\circ\text{C}$ to 70°C	●	1.0	2	V/mV
			$T_A = -40^\circ\text{C}$ to 85°C	●	0.7		V/mV
				●	0.6		V/mV
		$V_{OUT} = 1.5\text{V}$ to 3.5V , $R_L = 100\Omega$	$T_A = 0^\circ\text{C}$ to 70°C	●	0.7	1.5	V/mV
			$T_A = -40^\circ\text{C}$ to 85°C	●	0.5		V/mV
				●	0.4		V/mV
V_{OUT}	Maximum Output Swing (Positive)	$R_L = 500\Omega$, 30mV Overdrive	$T_A = 0^\circ\text{C}$ to 70°C	●	3.9	4.1	V
			$T_A = -40^\circ\text{C}$ to 85°C	●	3.8		V
				●	3.7		V
		$R_L = 100\Omega$, 30mV Overdrive	$T_A = 0^\circ\text{C}$ to 70°C	●	3.7	3.9	V
			$T_A = -40^\circ\text{C}$ to 85°C	●	3.6		V
				●	3.5		V
	Maximum Output Swing (Negative)	$R_L = 500\Omega$, 30mV Overdrive	$T_A = 0^\circ\text{C}$ to 70°C	●	0.9	1.1	V
			$T_A = -40^\circ\text{C}$ to 85°C	●		1.2	V
			●		1.3	V	
	$R_L = 100\Omega$, 30mV Overdrive	$T_A = 0^\circ\text{C}$ to 70°C	●	1.1	1.3	V	
$T_A = -40^\circ\text{C}$ to 85°C		●		1.4	V		
			●		1.5	V	

ELECTRICAL CHARACTERISTICS

The ● denotes the specifications which apply over the full operating temperature range, otherwise specifications are at $T_A = 25^\circ\text{C}$. $V_S = 5\text{V}$, $V_{CM} = 2.5\text{V}$, R_L to 2.5V, unless otherwise noted. (Note 8)

SYMBOL	PARAMETER	CONDITIONS	MIN	TYP	MAX	UNITS
I_{OUT}	Maximum Output Current	$V_{OUT} = 1.5\text{V}$ or 3.5V , 30mV Overdrive		±25	±35	mA
		$T_A = 0^\circ\text{C}$ to 70°C	●	±20		
		$T_A = -40^\circ\text{C}$ to 85°C	●	±17		
I_{SC}	Output Short-Circuit Current	$V_{OUT} = 2.5\text{V}$, 1V Overdrive (Note 3)		±55	±75	mA
		$T_A = 0^\circ\text{C}$ to 70°C	●	±45		
		$T_A = -40^\circ\text{C}$ to 85°C	●	±40		
SR	Slew Rate	$A_V = -1$ (Note 5)		200	350	V/μs
		$T_A = 0^\circ\text{C}$ to 70°C	●	150		
		$T_A = -40^\circ\text{C}$ to 85°C	●	125		
FPBW	Full Power Bandwidth	$2V_{P-P}$ (Note 6)		55		MHz
GBW	Gain Bandwidth Product	$f = 200\text{kHz}$, $R_L = 500\Omega$		65	94	MHz
		$T_A = 0^\circ\text{C}$ to 70°C	●	55		
		$T_A = -40^\circ\text{C}$ to 85°C	●	50		
-3dB BW	-3dB Bandwidth	$A_V = 1$, $R_L = 500\Omega$		180		MHz
t_r , t_f	Rise Time, Fall Time	$A_V = 1$, 10% to 90%, 0.1V, $R_L = 100\Omega$		2.1		ns
t_{PD}	Propagation Delay (Note 10)	$A_V = 1$, 50% to 50%, 0.1V, $R_L = 100\Omega$		3		ns
OS	Overshoot	$A_V = 1$, 0.1V, $R_L = 100\Omega$		25		%
t_s	Settling Time	$A_V = -1$, 0.1%, 2V		30		ns
THD	Total Harmonic Distortion	$A_V = 2$, $f = 1\text{MHz}$, $V_{OUT} = 2V_{P-P}$, $R_L = 500\Omega$		-75		dB
dG	Differential Gain	$A_V = 2$, $V_{OUT} = 2V_{P-P}$, $R_L = 150\Omega$		0.22		%
dP	Differential Phase	$A_V = 2$, $V_{OUT} = 2V_{P-P}$, $R_L = 150\Omega$		0.21		DEG
R_{OUT}	Output Resistance	$A_V = 1$, $f = 1\text{MHz}$		0.45		Ω
	Channel Separation	$V_{OUT} = 1.5\text{V}$ to 3.5V , $R_L = 100\Omega$		81	100	dB
	$T_A = 0^\circ\text{C}$ to 70°C	●	80			
	$T_A = -40^\circ\text{C}$ to 85°C	●	79			
I_S	Supply Current	Per Amplifier		2.9	4.0	mA
		$T_A = 0^\circ\text{C}$ to 70°C	●		5.0	mA
		$T_A = -40^\circ\text{C}$ to 85°C	●		5.5	mA

Note 1: Absolute Maximum Ratings are those values beyond which the life of the device may be impaired.

Note 2: Differential inputs of ±6V are appropriate for transient operation only, such as during slewing. Large sustained differential inputs can cause excessive power dissipation and may damage the part.

Note 3: A heat sink may be required to keep the junction temperature below absolute maximum when the output is shorted indefinitely.

Note 4: Input offset voltage is pulse tested and is exclusive of warm-up drift.

Note 5: Slew rate is measured between ±2V at the output with ±3V input for ±5V supplies and $2V_{P-P}$ at the output with a $3V_{P-P}$ input for single 5V supplies.

Note 6: Full power bandwidth is calculated from the slew rate:

$$FPBW = SR/2\pi V_P$$

Note 7: This parameter is not 100% tested

Note 8: The LT1813C/LT1814C are guaranteed to meet specified performance from 0°C to 70°C and is designed, characterized and expected to meet the extended temperature limits, but is not tested at -40°C and 85°C . The LT1813I/LT1814I are guaranteed to meet the extended temperature limits.

Note 9: The LT1813D is 100% production tested at 25°C . It is designed, characterized and expected to meet the 0°C to 70°C specifications although it is not tested or QA sampled at these temperatures. The LT1813D is guaranteed functional from -40°C to 85°C but may not meet those specifications.

Note 10: Propagation delay is measured from the 50% point on the input waveform to the 50% point on the output waveform.

TYPICAL PERFORMANCE CHARACTERISTICS

Supply Current vs Temperature

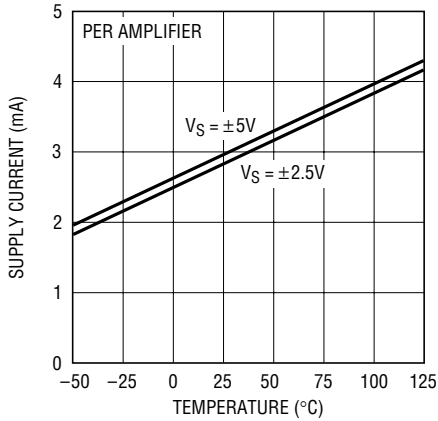

1813/14 G01

Input Common Mode Range vs Supply Voltage

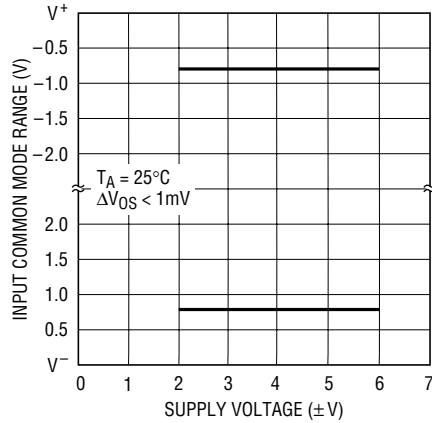

1813/14 G02

Input Bias Current vs Common Mode Voltage

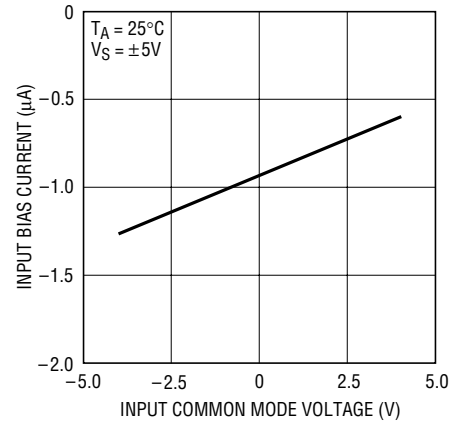

1813/14 G03

Input Bias Current vs Temperature

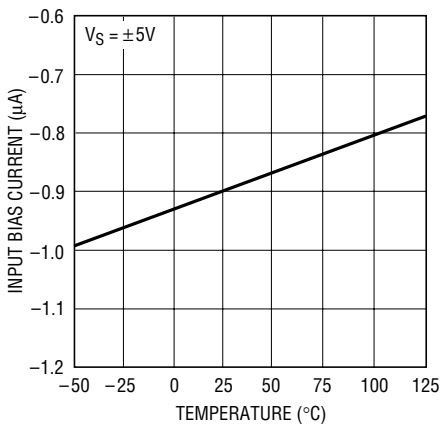

1813/14 G04

Input Noise Spectral Density

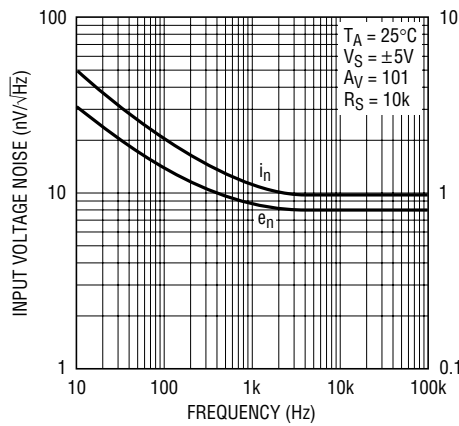

1813/14 G05

Open-Loop Gain vs Resistive Load

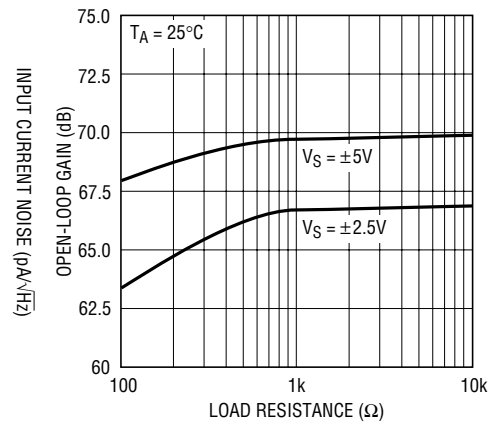

1813/14 G06

Open-Loop Gain vs Temperature

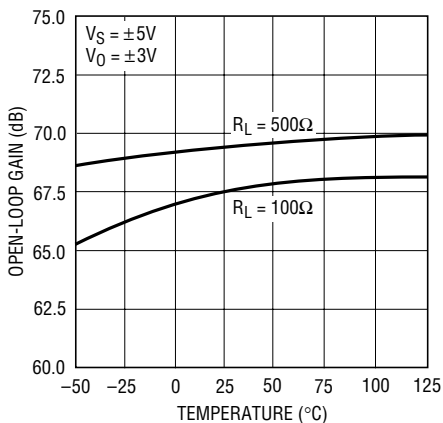

1813/14 G07

Output Voltage Swing vs Supply Voltage

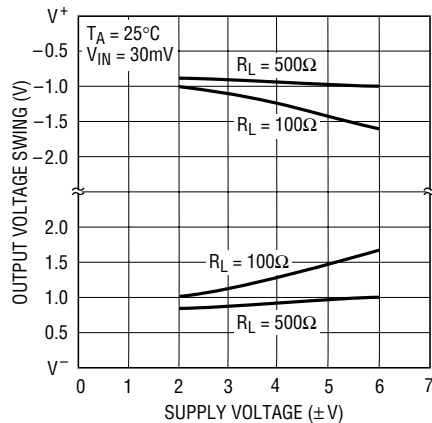

1813/14 G02

Output Voltage Swing vs Load Current

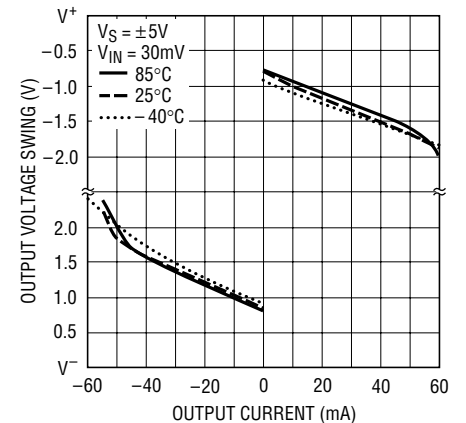

1813/14 G09

TYPICAL PERFORMANCE CHARACTERISTICS

Output Short-Circuit Current vs Temperature

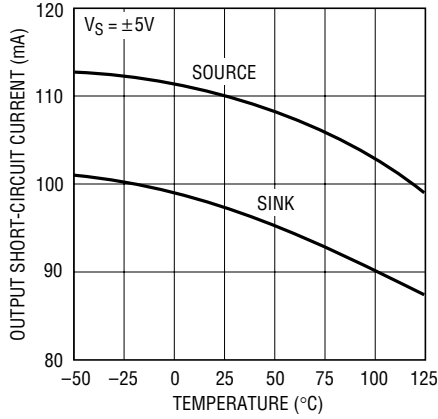

1813/14 G10

Settling Time vs Output Step

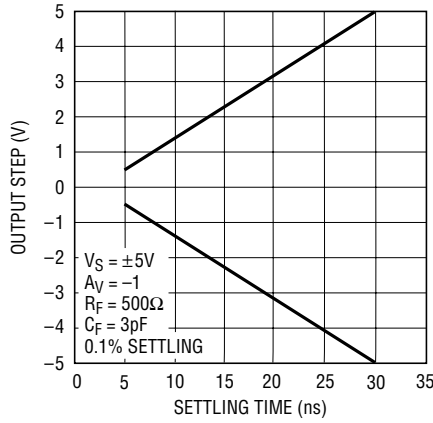

1813/14 G11

Output Impedance vs Frequency

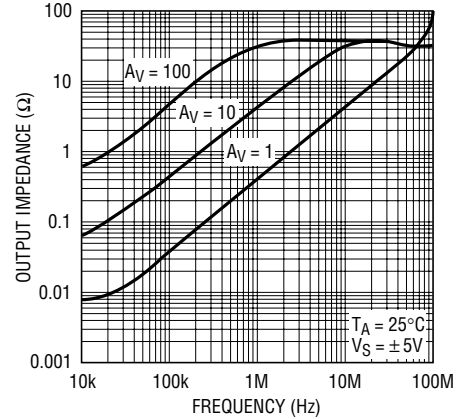

1813/14 G12

Gain and Phase vs Frequency

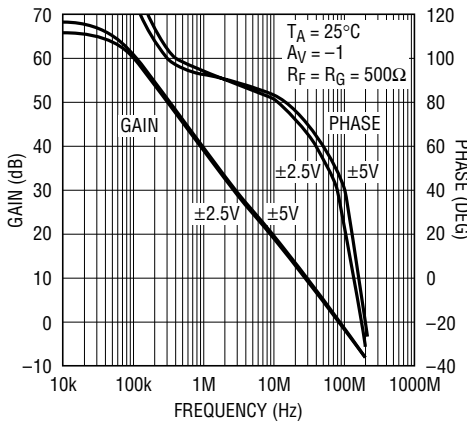

1813/14 G13

Crosstalk vs Frequency

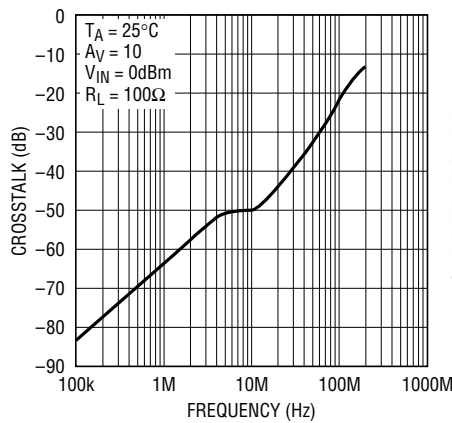

1813/14 G14

Gain Bandwidth and Phase Margin vs Temperature

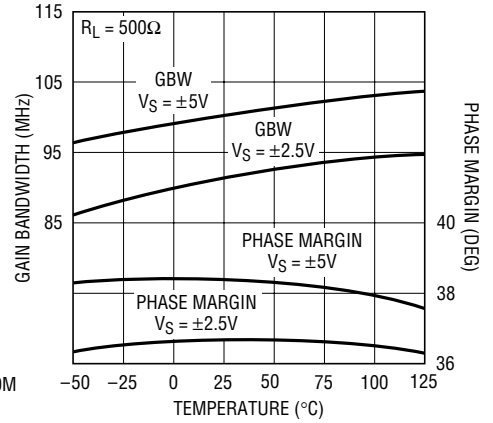

1813/14 G15

Frequency Response vs Supply Voltage, A_V = 1

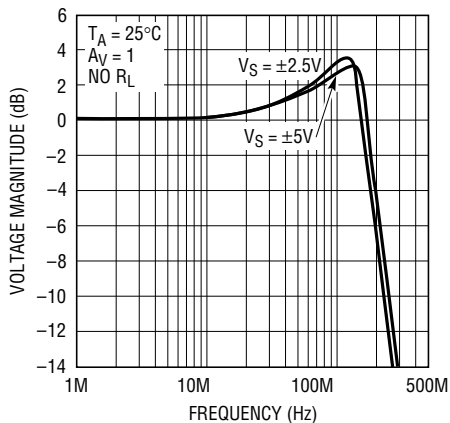

1813/14 G16

Frequency Response vs Supply Voltage, A_V = 2

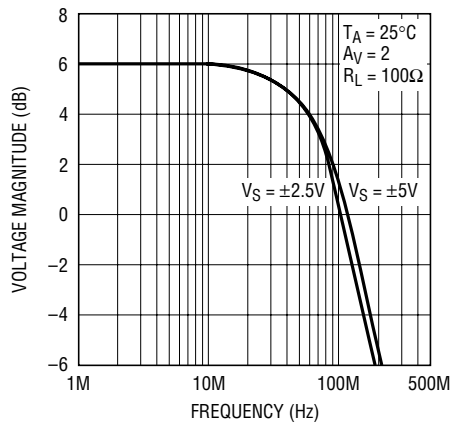

1813/14 G17

Frequency Response vs Capacitive Load, A_V = -1

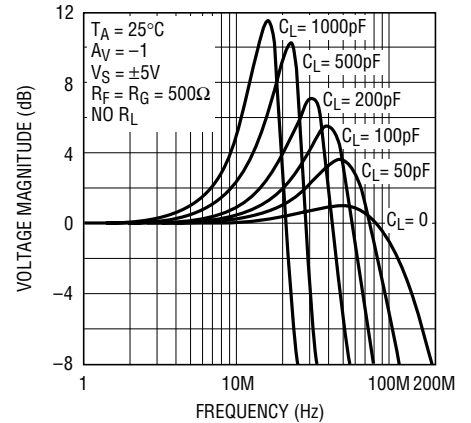

1813/14 G18

TYPICAL PERFORMANCE CHARACTERISTICS

Gain Bandwidth and Phase Margin vs Supply Voltage

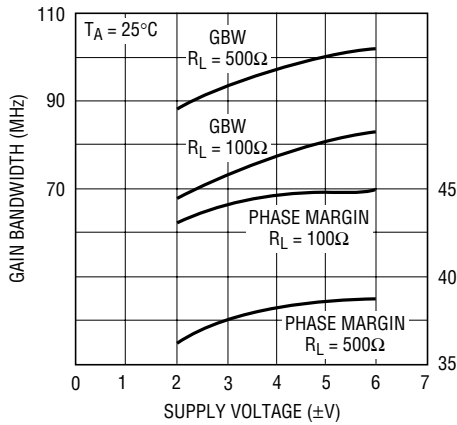

1813/14 G19

Power Supply Rejection Ratio vs Frequency

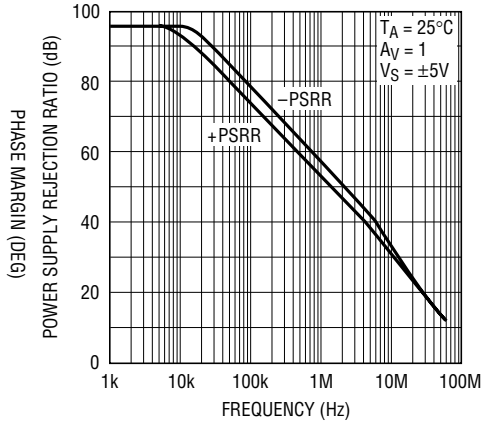

1813/14 G20

Common Mode Rejection Ratio vs Frequency

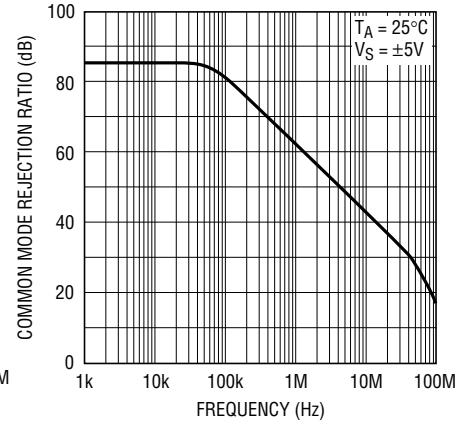

1813/14 G21

Slew Rate vs Supply Voltage

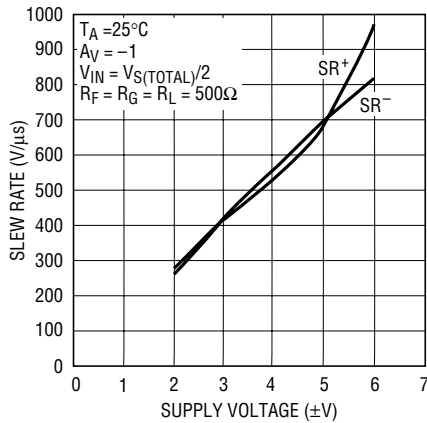

1813/14 G22

Slew Rate vs Supply Voltage

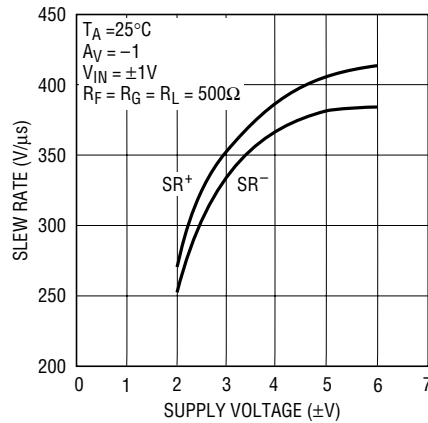

1813/14 G23

Slew Rate vs Input Level

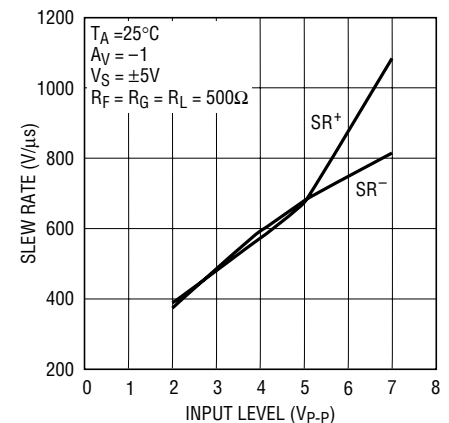

1813/14 G24

Slew Rate vs Temperature

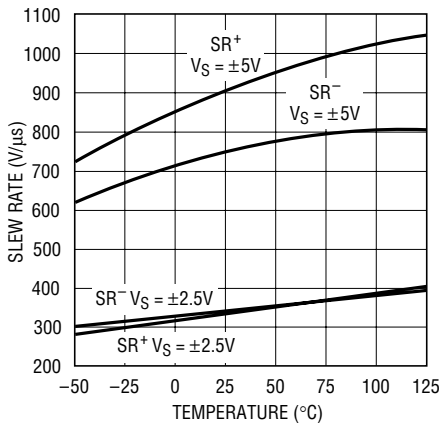

1813/14 G25

Total Harmonic Distortion + Noise vs Frequency

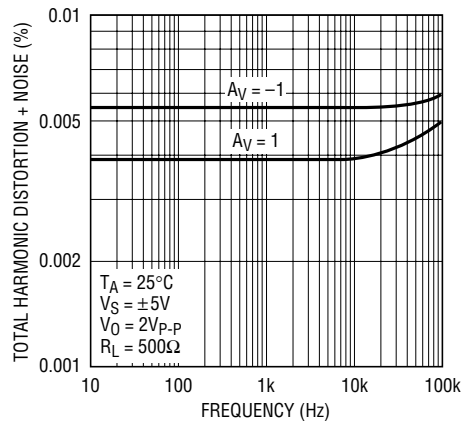

1813/14 G26

Undistorted Output Swing vs Frequency

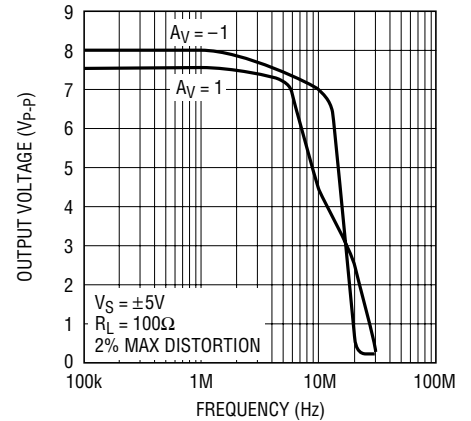

1813/14 G27

TYPICAL PERFORMANCE CHARACTERISTICS

2nd and 3rd Harmonic Distortion vs Frequency

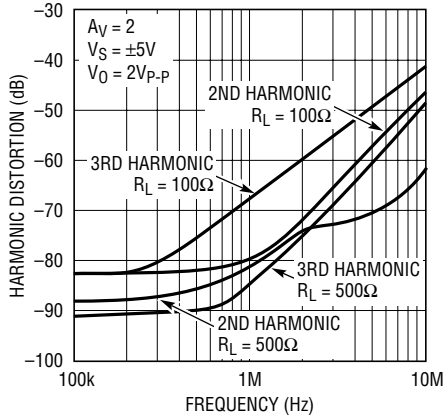

1813/14 G28

Differential Gain and Phase vs Supply Voltage

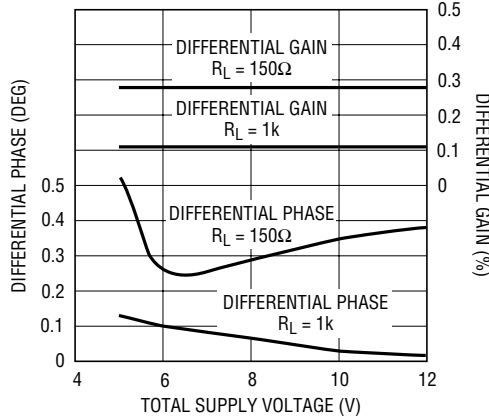

1813/14 G29

Capacitive Load Handling

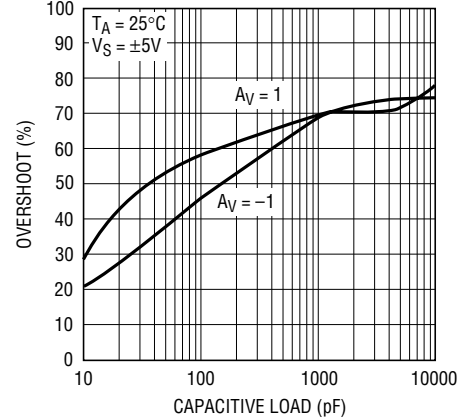

1813/14 G30

Small-Signal Transient ($A_V = 1$)

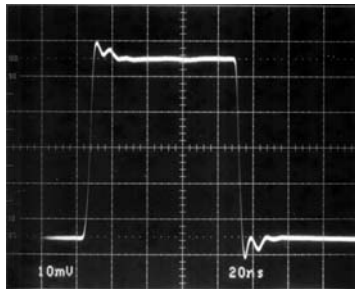

1813/14 G31

Small-Signal Transient ($A_V = -1$)

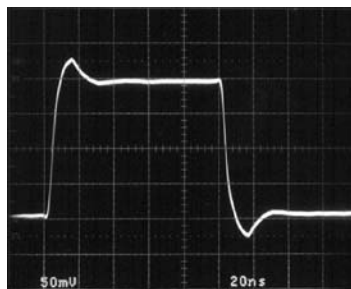

1813/14 G32

Small-Signal Transient ($A_V = 1$, $C_L = 100pF$)

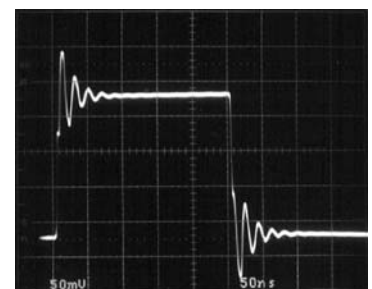

1813/14 G33

Large-Signal Transient ($A_V = 1$)

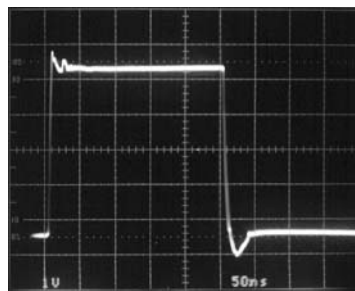

1813/14 G34

Large-Signal Transient ($A_V = -1$)

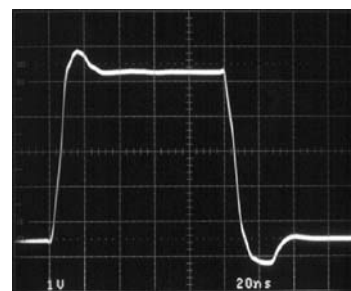

1813/14 G35

Large-Signal Transient ($A_V = -1$, $C_L = 200pF$)

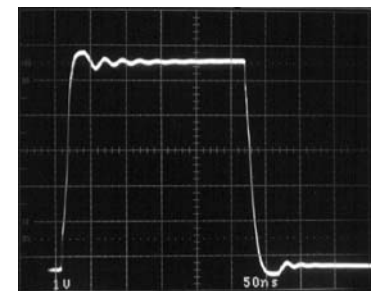

1813/14 G36

APPLICATIONS INFORMATION

Layout and Passive Components

The LT1813/LT1814 amplifiers are more tolerant of less than ideal board layouts than other high speed amplifiers. For optimum performance, a ground plane is recommended and trace lengths should be minimized, especially on the negative input lead.

Low ESL/ESR bypass capacitors should be placed directly at the positive and negative supply pins (0.01 μ F ceramics are recommended). For high drive current applications, additional 1 μ F to 10 μ F tantalums should be added.

The parallel combination of the feedback resistor and gain setting resistor on the inverting input combine with the input capacitance to form a pole that can cause peaking or even oscillations. If feedback resistors greater than 1k are used, a parallel capacitor of value:

$$C_F > R_G \cdot C_{IN}/R_F$$

should be used to cancel the input pole and optimize dynamic performance. For applications where the DC noise gain is 1 and a large feedback resistor is used, C_F should be greater than or equal to C_{IN} . An example would be an I-to-V converter.

Input Considerations

The inputs of the LT1813/LT1814 amplifiers are connected to the base of an NPN and PNP bipolar transistor in parallel. The base currents are of opposite polarity and provide first order bias current cancellation. Due to variation in the matching of NPN and PNP beta, the polarity of the input bias current can be positive or negative. The offset current, however, does not depend on beta matching and is tightly controlled. Therefore, the use of balanced source resistance at each input is recommended for applications where DC accuracy must be maximized. For example, with a 100 Ω source resistance at each input, the 400nA maximum offset current results in only 40 μ V of extra offset, while without balance the 4 μ A maximum input bias current could result in a 0.4mV offset contribution.

The inputs can withstand differential input voltages of up to 6V without damage and without needing clamping or

series resistance for protection. This differential input voltage generates a large internal current (up to 40mA), which results in the high slew rate. In normal transient closed-loop operation, this does not increase power dissipation significantly because of the low duty cycle of the transient inputs. Sustained differential inputs, however, will result in excessive power dissipation and therefore **this device should not be used as a comparator.**

Capacitive Loading

The LT1813/LT1814 are stable with capacitive loads from 0pF to 1000pF, which is outstanding for a 100MHz amplifier. The internal compensation circuitry accomplishes this by sensing the load induced output pole and adding compensation at the amplifier gain node as needed. As the capacitive load increases, both the bandwidth and phase margin decrease so there will be peaking in the frequency domain and ringing in the transient response. Coaxial cable can be driven directly, but for best pulse fidelity a resistor of value equal to the characteristic impedance of the cable (e.g., 75 Ω) should be placed in series with the output. The receiving end of the cable should be terminated with the same value resistance to ground.

Slew Rate

The slew rate of the LT1813/LT1814 is proportional to the differential input voltage. Highest slew rates are therefore seen in the lowest gain configurations. For example, a 5V output step in a gain of 10 has a 0.5V input step, whereas in unity gain there is a 5V input step. The LT1813/LT1814 is tested for a slew rate in a gain of -1. Lower slew rates occur in higher gain configurations.

Power Dissipation

The LT1813/LT1814 combine two or four amplifiers with high speed and large output drive in a small package. It is possible to exceed the maximum junction temperature specification under certain conditions. Maximum junction temperature (T_J) is calculated from the ambient temperature (T_A) and power dissipation (P_D) as follows:

$$T_J = T_A + (P_D \cdot \theta_{JA})$$

APPLICATIONS INFORMATION

Power dissipation is composed of two parts. The first is due to the quiescent supply current and the second is due to on-chip dissipation caused by the load current. The worst-case load induced power occurs when the output voltage is at 1/2 of either supply voltage (or the maximum swing if less than 1/2 the supply voltage). Therefore P_{DMAX} is:

$$P_{DMAX} = (V^+ - V^-) \cdot (I_{SMAX}) + (V^+/2)^2/R_L \text{ or}$$

$$P_{DMAX} = (V^+ - V^-) \cdot (I_{SMAX}) + (V^+ - V_{OMAX}) \cdot (V_{OMAX}/R_L)$$

Example: LT1814S at 70°C, $V_S = \pm 5V$, $R_L = 100\Omega$

$$P_{DMAX} = (10V) \cdot (4.5mA) + (2.5V)^2/100\Omega = 108mW$$

$$T_{JMAX} = 70^\circ C + (4 \cdot 108mW) \cdot (100^\circ C/W) = 113^\circ C$$

Circuit Operation

The LT1813/LT1814 circuit topology is a true voltage feedback amplifier that has the slewing behavior of a current feedback amplifier. The operation of the circuit can be understood by referring to the Simplified Schematic. Complementary NPN and PNP emitter followers buffer the inputs and drive an internal resistor. The input voltage appears across the resistor, generating current that is mirrored into the high impedance node.

Complementary followers form an output stage that buffers the gain node from the load. The input resistor, input stage transconductance, and the capacitor on the high impedance node determine the bandwidth. The slew rate is determined by the current available to charge the gain node capacitance. This current is the differential input voltage divided by R_1 , so the slew rate is proportional to the input step. Highest slew rates are therefore seen in the lowest gain configurations.

The RC network across the output stage is bootstrapped when the amplifier is driving a light or moderate load and has no effect under normal operation. When a heavy load (capacitive or resistive) is driven, the network is incompletely bootstrapped and adds to the compensation at the high impedance node. The added capacitance moves the unity-gain frequency away from the pole formed by the output impedance and the capacitive load. The zero created by the RC combination adds phase to ensure that the total phase lag does not exceed 180° (zero phase margin), and the amplifier remains stable. In this way, the LT1813/LT1814 are stable with up to 1000pF capacitive loads in unity gain, and even higher capacitive loads in higher closed-loop gain configurations.

SIMPLIFIED SCHEMATIC (one amplifier)

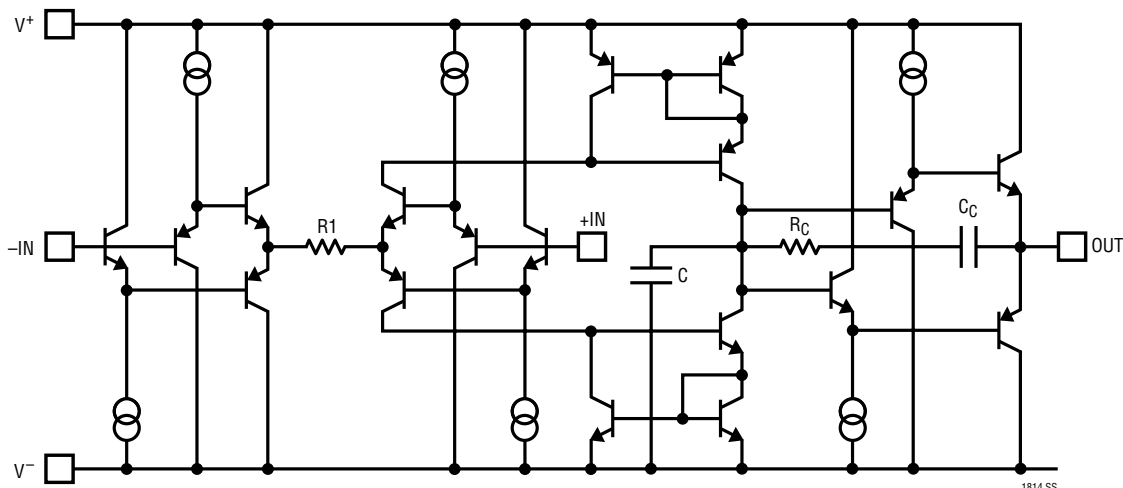

TYPICAL APPLICATION

4MHz, 4th Order Butterworth Filter

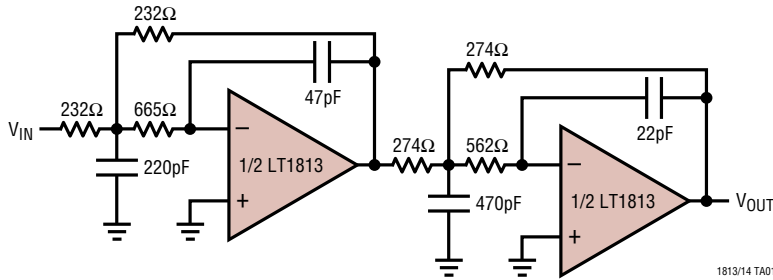

1813/14 TA01

Filter Frequency Response

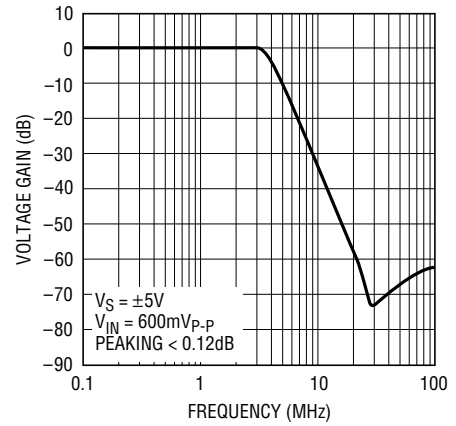

1813/14 TA02

Gain of 20 Composite Amplifier Drives Differential Load with Low Distortion

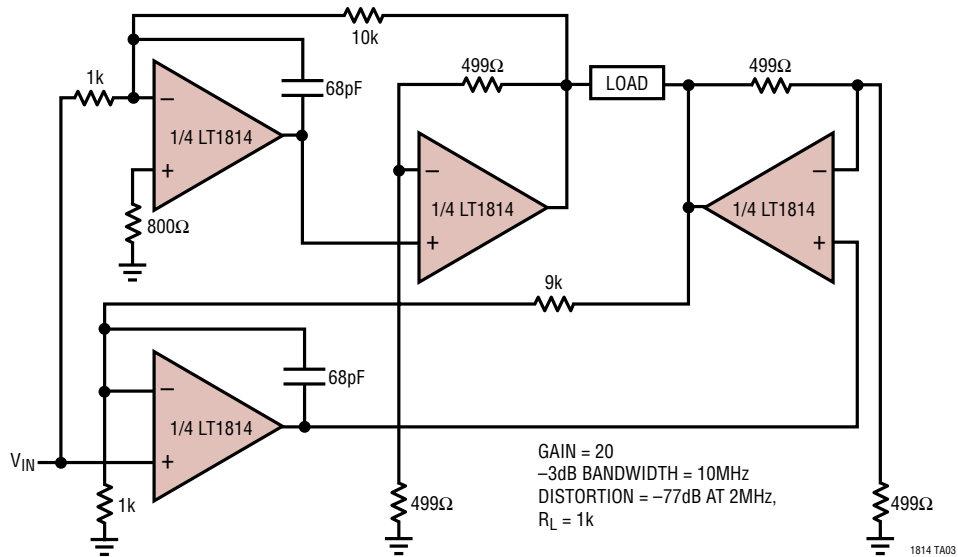

1814 TA03

PACKAGE DESCRIPTION

DD Package
8-Lead Plastic DFN (3mm × 3mm)
 (Reference LTC DWG # 05-08-1698)

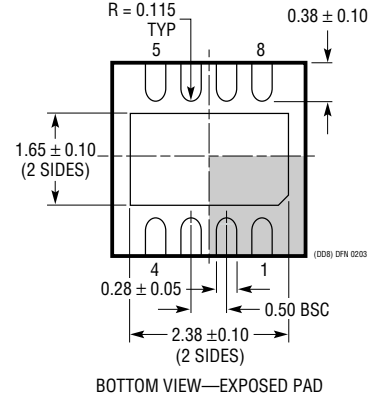
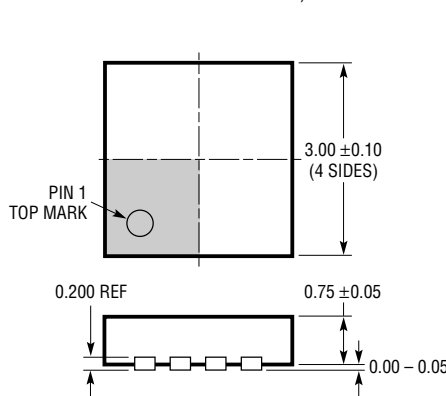
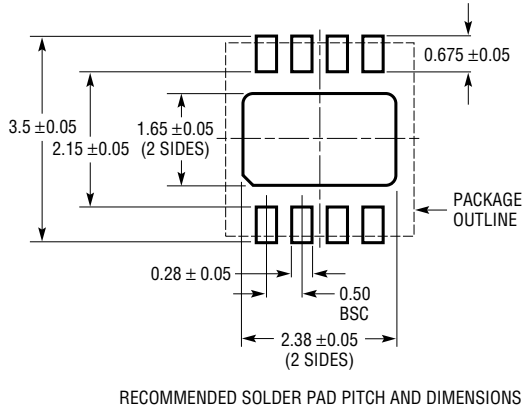

NOTE:

1. DRAWING TO BE MADE A JEDEC PACKAGE OUTLINE MO-229 VARIATION OF (WEED-1)
2. ALL DIMENSIONS ARE IN MILLIMETERS
3. DIMENSIONS OF EXPOSED PAD ON BOTTOM OF PACKAGE DO NOT INCLUDE MOLD FLASH. MOLD FLASH, IF PRESENT, SHALL NOT EXCEED 0.15mm ON ANY SIDE
4. EXPOSED PAD SHALL BE SOLDER PLATED

MS8 Package
8-Lead Plastic MSOP
 (Reference LTC DWG # 05-08-1660)

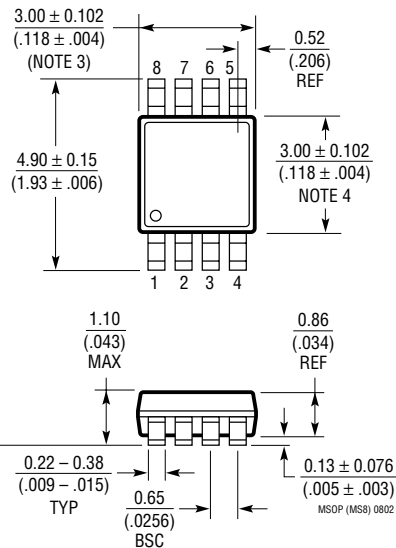
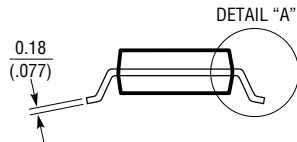
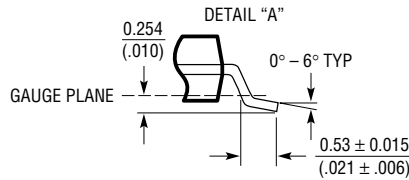
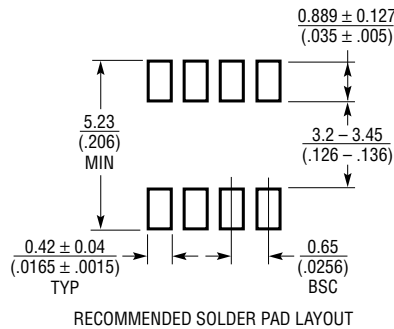

NOTE:

1. DIMENSIONS IN MILLIMETER/(INCH)
2. DRAWING NOT TO SCALE
3. DIMENSION DOES NOT INCLUDE MOLD FLASH, PROTRUSIONS OR GATE BURRS. MOLD FLASH, PROTRUSIONS OR GATE BURRS SHALL NOT EXCEED 0.152mm (.006") PER SIDE
4. DIMENSION DOES NOT INCLUDE INTERLEAD FLASH OR PROTRUSIONS. INTERLEAD FLASH OR PROTRUSIONS SHALL NOT EXCEED 0.152mm (.006") PER SIDE
5. LEAD COPLANARITY (BOTTOM OF LEADS AFTER FORMING) SHALL BE 0.102mm (.004") MAX

PACKAGE DESCRIPTION

S8 Package 8-Lead Plastic Small Outline (Narrow .150 Inch) (Reference LTC DWG # 05-08-1610)

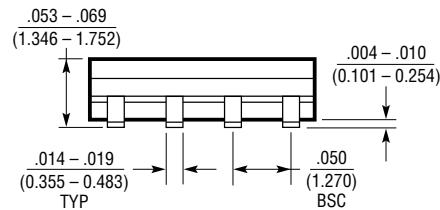
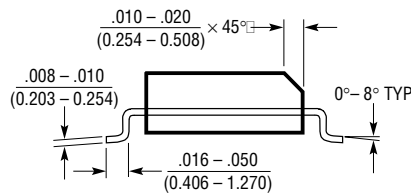
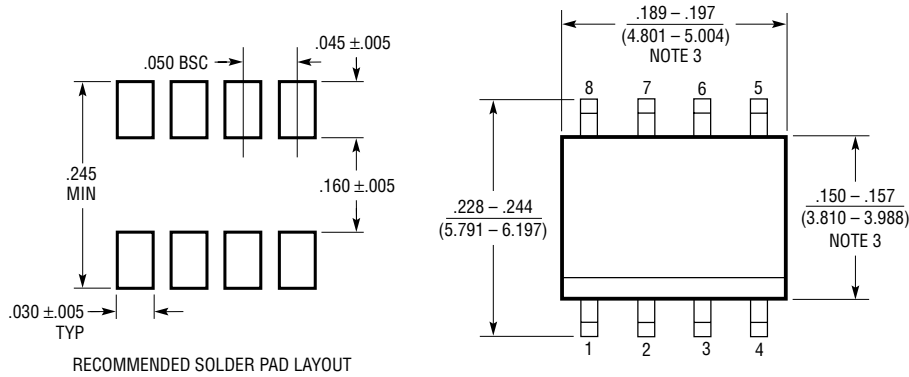

- NOTE:
1. DIMENSIONS IN $\frac{\text{INCHES}}{\text{MILLIMETERS}}$
2. DRAWING NOT TO SCALE
3. THESE DIMENSIONS DO NOT INCLUDE MOLD FLASH OR PROTRUSIONS.
MOLD FLASH OR PROTRUSIONS SHALL NOT EXCEED $.006''$ (0.15mm)

S08 0303

S Package 14-Lead Plastic Small Outline (Narrow .150 Inch) (Reference LTC DWG # 05-08-1610)

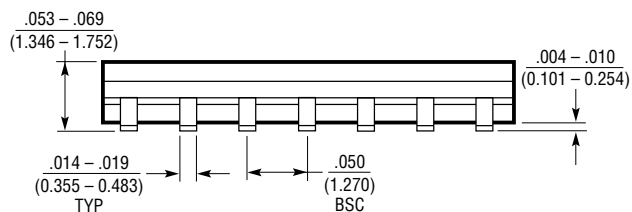
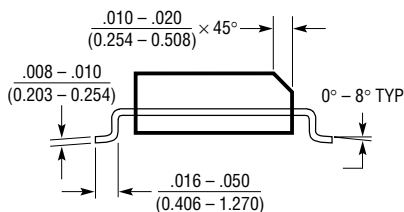
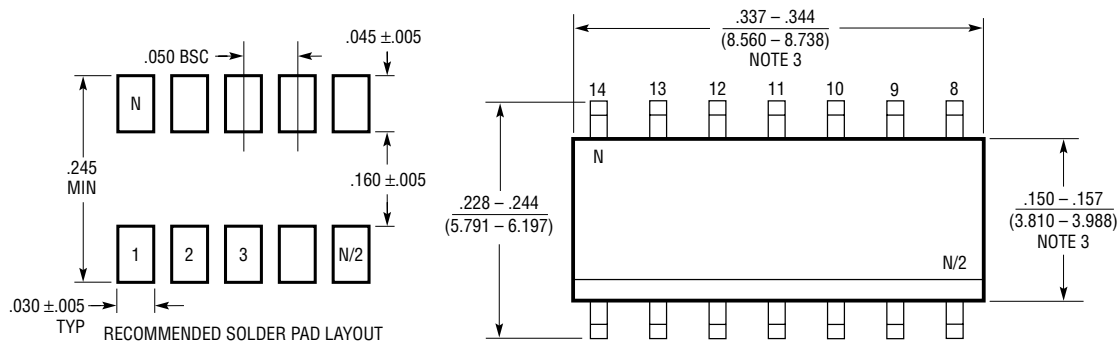

- NOTE:
1. DIMENSIONS IN $\frac{\text{INCHES}}{\text{MILLIMETERS}}$
2. DRAWING NOT TO SCALE
3. THESE DIMENSIONS DO NOT INCLUDE MOLD FLASH OR PROTRUSIONS.
MOLD FLASH OR PROTRUSIONS SHALL NOT EXCEED $.006''$ (0.15mm)

S14 0502

LT1813/LT1814

TYPICAL APPLICATION

Two Op Amp Instrumentation Amplifier

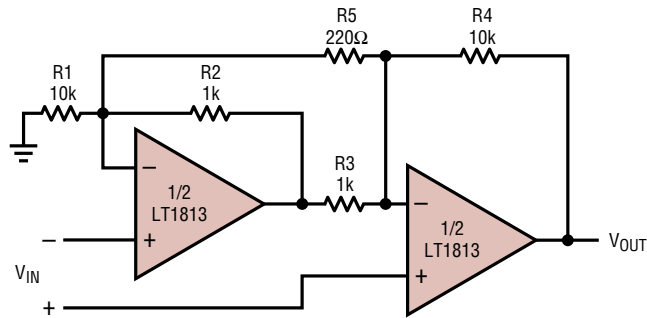

$$\text{GAIN} = \left[\frac{R4}{R3} \right] \left[1 + \left(\frac{1}{2} \right) \left(\frac{R2}{R1} + \frac{R3}{R4} \right) + \frac{R2 + R3}{R5} \right] = 102$$

TRIM R5 FOR GAIN
TRIM R1 FOR COMMON MODE REJECTION
BW = 1MHz

1813/14 TA03

PACKAGE DESCRIPTION

GN Package

16-Lead Plastic SSOP (Narrow .150 Inch)
(Reference LTC DWG # 05-08-1641)

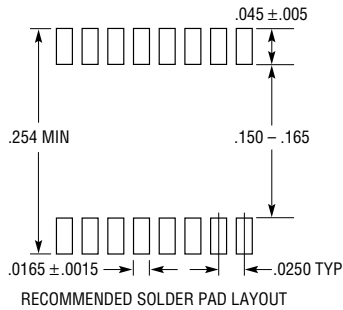

NOTE:

1. CONTROLLING DIMENSION: INCHES
2. DIMENSIONS ARE IN INCHES (MILLIMETERS)
3. DRAWING NOT TO SCALE

*DIMENSION DOES NOT INCLUDE MOLD FLASH. MOLD FLASH SHALL NOT EXCEED 0.006" (0.152mm) PER SIDE

**DIMENSION DOES NOT INCLUDE INTERLEAD FLASH. INTERLEAD FLASH SHALL NOT EXCEED 0.010" (0.254mm) PER SIDE

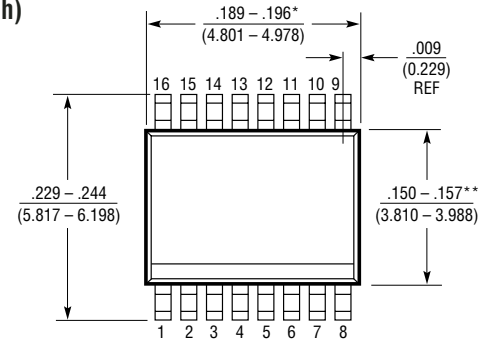
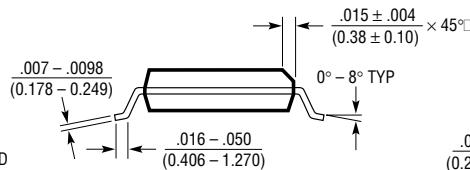

GN16 (SSOP) 0502

RELATED PARTS

PART NUMBER	DESCRIPTION	COMMENTS
LT1363/LT1364/LT1365	Single/Dual/Quad 70MHz, 1000V/μs, C-Load™ Op Amps	±2.5V to ±15V Operation
LT1395/LT1396/LT1397	Single/Dual/Quad 400MHz Current Feedback Amplifiers	4.6mA Supply Current, 800V/μs, 80mA Output Current
LT1806/LT1807	Single/Dual 325MHz, 140V/μs Rail-to-Rail I/O Op Amps	Low Noise 3.5nV/√Hz
LT1809/LT1810	Single/Dual 180MHz, 350V/μs Rail-to-Rail I/O Op Amps	Low Distortion -90dBc at 5MHz
LT1812	Single 3mA, 100MHz, 750V/μs Op Amp	Single Version of LT1813/LT1814; 50μA Shutdown Option
LT1815/LT1816/LT1817	Single/Dual/Quad 220MHz, 1500V/μs Op Amps	6.5mA Supply Current, 6nV/√Hz Input Noise

C-Load is a trademark of Linear Technology Corporation.



Компания «ЭлектроПласт» предлагает заключение долгосрочных отношений при поставках импортных электронных компонентов на взаимовыгодных условиях!

Наши преимущества:

- Оперативные поставки широкого спектра электронных компонентов отечественного и импортного производства напрямую от производителей и с крупнейших мировых складов;
- Поставка более 17-ти миллионов наименований электронных компонентов;
- Поставка сложных, дефицитных, либо снятых с производства позиций;
- Оперативные сроки поставки под заказ (от 5 рабочих дней);
- Экспресс доставка в любую точку России;
- Техническая поддержка проекта, помощь в подборе аналогов, поставка прототипов;
- Система менеджмента качества сертифицирована по Международному стандарту ISO 9001;
- Лицензия ФСБ на осуществление работ с использованием сведений, составляющих государственную тайну;
- Поставка специализированных компонентов (Xilinx, Altera, Analog Devices, Intersil, Interpoint, Microsemi, Aeroflex, Peregrine, Syfer, Eurofarad, Texas Instrument, Miteq, Cobham, E2V, MA-COM, Hittite, Mini-Circuits, General Dynamics и др.);

Помимо этого, одним из направлений компании «ЭлектроПласт» является направление «Источники питания». Мы предлагаем Вам помощь Конструкторского отдела:

- Подбор оптимального решения, техническое обоснование при выборе компонента;
- Подбор аналогов;
- Консультации по применению компонента;
- Поставка образцов и прототипов;
- Техническая поддержка проекта;
- Защита от снятия компонента с производства.



Как с нами связаться

Телефон: 8 (812) 309 58 32 (многоканальный)

Факс: 8 (812) 320-02-42

Электронная почта: org@eplast1.ru

Адрес: 198099, г. Санкт-Петербург, ул. Калинина, дом 2, корпус 4, литера А.