

SERIES: SMI6 | DESCRIPTION: AC-DC POWER SUPPLY
FEATURES

- DoE Level VI, CoC Tier 2 efficiency
- up to 6 W power
- interchangeable AC blades
- universal input (90~264 Vac)
- single regulated output from 5~15 Vdc
- over voltage and short circuit protections
- UL/cUL, GS, RCM, CCC, PSE safety approvals
- custom designs available



MODEL	output voltage	output current max	output power max	ripple and noise ¹ max	efficiency level ²
	(Vdc)	(A)	(W)	(mVp-p)	
SMI6-5	5	1.2	6	150	VI
SMI6-5.95	5.95	1	6	150	VI
SMI6-9	9	0.67	6	150	VI
SMI6-12	12	0.5	6	200	VI
SMI6-15	15	0.4	6	200	VI

Notes: 1. At full load, 100-240 Vac input, 20 MHz bandwidth oscilloscope, output terminated with 0.1 μ F ceramic and 10 μ F electrolytic capacitors.
2. CoC Tier 2 compliant

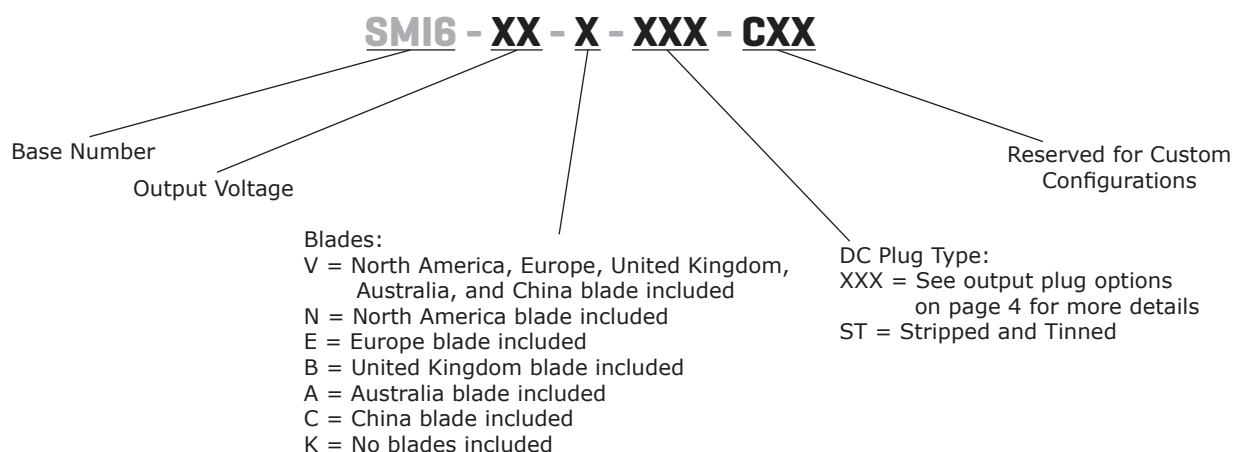
PART NUMBER KEY

INPUT

parameter	conditions/description	min	typ	max	units
voltage		90		264	Vac
frequency		47		63	Hz
current				0.3	A
leakage current				0.25	mA
no load power consumption				0.075	W

OUTPUT

parameter	conditions/description	min	typ	max	units
line regulation			±1		%
load regulation	5 Vdc output model all other models		±6 ±5		% %

PROTECTIONS

parameter	conditions/description	min	typ	max	units
over voltage protection	output shut down, auto recovery				
short circuit protection	output shut down, auto recovery				

SAFETY & COMPLIANCE

parameter	conditions/description	min	typ	max	units
isolation voltage	input to output at 10 mA for 1 minute		3,000 4,242		Vac Vdc
isolation resistance	input to output at 500 Vdc	100			MΩ
safety approvals	UL/cUL, GS, RCM, CCC, PSE				
EMI/EMC	FCC Part 15B Class B, CE				
RoHS	yes				

ENVIRONMENTAL

parameter	conditions/description	min	typ	max	units
operating temperature		0		40	°C
storage temperature		-10		70	°C
operating humidity	non-condensing	20		80	%
storage humidity	non-condensing	10		90	%

MECHANICAL

parameter	conditions/description	min	typ	max	units
dimensions	64 x 40.5 x 30				mm
inlet plug	interchangeable blades (North America, Europe, UK, Australia, China)				
weight	5.95 Vdc model (without interchangeable blades)		69		g
	all other models (without interchangeable blades)		68.5		g

MECHANICAL DRAWING

units: mm
tolerance: ±1 mm

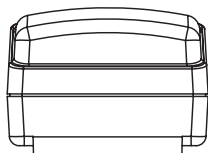
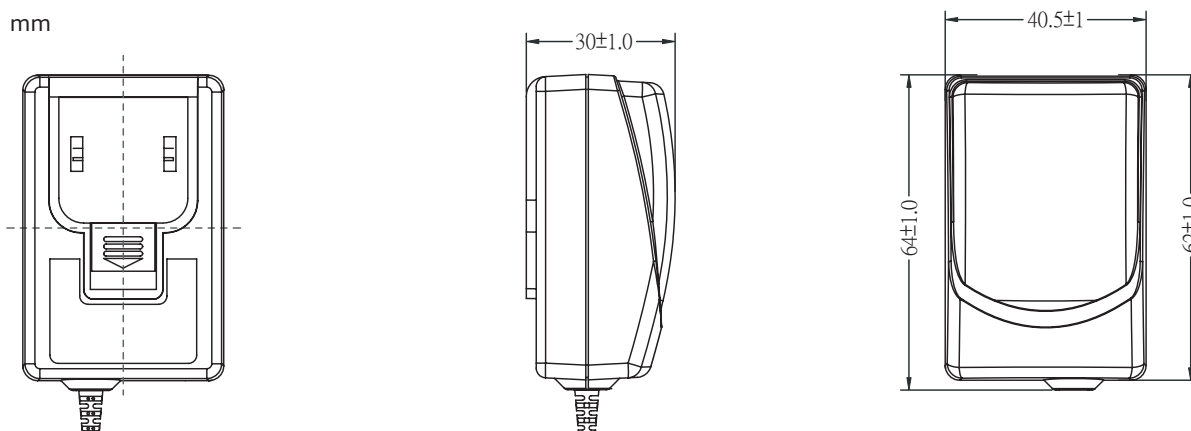

INTERCHANGEABLE BLADES					
BLADE DESIGNATOR	N	E	B	A	C
REGION	North America	Europe	UK	Australia	China
BLADE ACCESSORY	SMI-US-1	SMI-EU-1	SMI-UK-1	SMI-AU-1	SMI-CN-1
BLADE					

DC CORD

units: mm

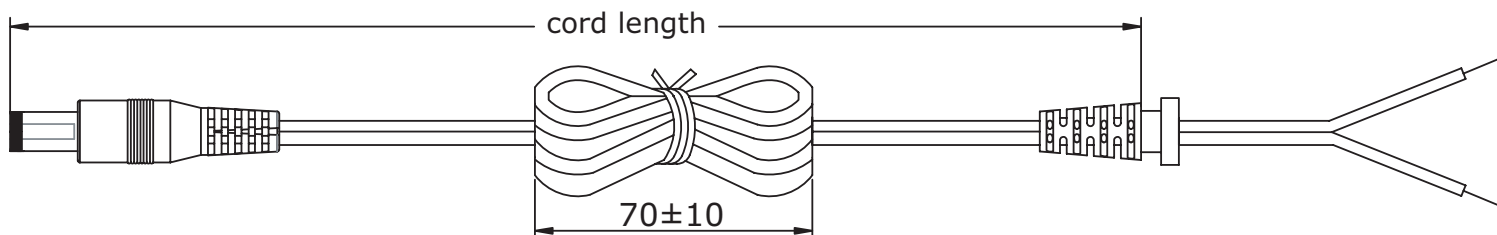
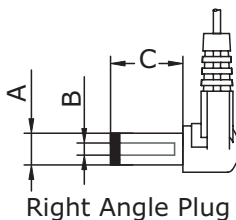
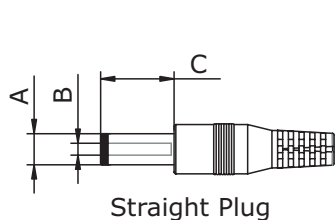

Table 1

MODEL NO.	CABLE	CORD LENGTH
SMI6-5	UL2468, 20 AWG	1,530 mm ±100
SMI6-5.95	UL2468, 20 AWG	1,530 mm ±100
SMI6-9	UL2468, 22 AWG	1,530 mm ±100
SMI6-12	UL2468, 22 AWG	1,530 mm ±100
SMI6-15	UL2468, 22 AWG	1,530 mm ±100

OUTPUT PLUG OPTIONS

Standard DC Plug



Size	A	B	C	Unit
5	5.5	2.1	9.5	mm
6	5.5	2.5	9.5	mm
7	3.5	1.35	9.5	mm
8	3.8	1.35	9.5	mm
9	3.8	1.05	9.5	mm

Locking DC Plug

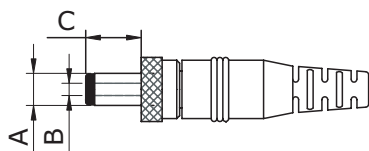

Size	A	B	C	Unit
10	5.5	2.1	9.5	mm
11	5.5	2.5	9.5	mm

EIAJ DC Plug

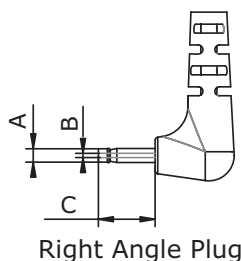
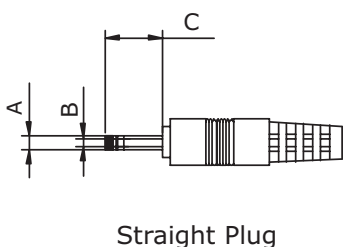

Size	EIAJ	A	B	C	Unit
12	EIAJ-1	2.35	0.7	9.5	mm
13	EIAJ-2	4.0	1.7	9.5	mm
14	EIAJ-3	4.75	1.7	9.5	mm

Stripped and Tinned

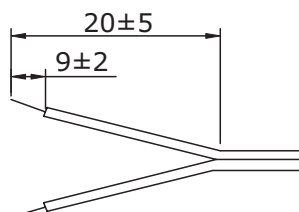

DC Plug Type

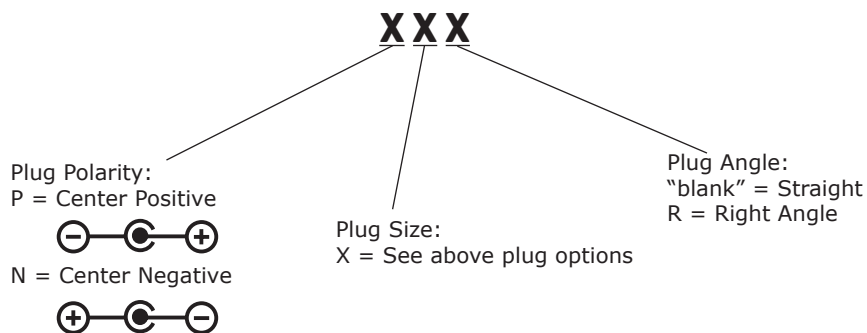

*Contact CUI for additional plug options

REVISION HISTORY

rev.	description	date
1.0	initial release	07/01/2015
1.01	updated datasheet	02/08/2016
1.02	updated datasheet	09/14/2016
1.03	Australia blade housing changed, and blade orientation rotated 90 degrees	10/02/2018

The revision history provided is for informational purposes only and is believed to be accurate.



Headquarters
20050 SW 112th Ave.
Tualatin, OR 97062
800.275.4899

Fax 503.612.2383
cui.com
techsupport@cui.com

This device complies with part 15 of the FCC Rules. Operation is subject to the following two conditions:

- (1) This device may not cause harmful interference, and
- (2) this device must accept any interference received, including interference that may cause undesired operation.

CUI offers a one (1) year limited warranty. Complete warranty information is listed on our website.

CUI reserves the right to make changes to the product at any time without notice. Information provided by CUI is believed to be accurate and reliable. However, no responsibility is assumed by CUI for its use, nor for any infringements of patents or other rights of third parties which may result from its use.

CUI products are not authorized or warranted for use as critical components in equipment that requires an extremely high level of reliability. A critical component is any component of a life support device or system whose failure to perform can be reasonably expected to cause the failure of the life support device or system, or to affect its safety or effectiveness.



Компания «ЭлектроПласт» предлагает заключение долгосрочных отношений при поставках импортных электронных компонентов на взаимовыгодных условиях!

Наши преимущества:

- Оперативные поставки широкого спектра электронных компонентов отечественного и импортного производства напрямую от производителей и с крупнейших мировых складов;
- Поставка более 17-ти миллионов наименований электронных компонентов;
- Поставка сложных, дефицитных, либо снятых с производства позиций;
- Оперативные сроки поставки под заказ (от 5 рабочих дней);
- Экспресс доставка в любую точку России;
- Техническая поддержка проекта, помощь в подборе аналогов, поставка прототипов;
- Система менеджмента качества сертифицирована по Международному стандарту ISO 9001;
- Лицензия ФСБ на осуществление работ с использованием сведений, составляющих государственную тайну;
- Поставка специализированных компонентов (Xilinx, Altera, Analog Devices, Intersil, Interpoint, Microsemi, Aeroflex, Peregrine, Syfer, Eurofarad, Texas Instrument, Miteq, Cobham, E2V, MA-COM, Hittite, Mini-Circuits, General Dynamics и др.);

Помимо этого, одним из направлений компании «ЭлектроПласт» является направление «Источники питания». Мы предлагаем Вам помощь Конструкторского отдела:

- Подбор оптимального решения, техническое обоснование при выборе компонента;
- Подбор аналогов;
- Консультации по применению компонента;
- Поставка образцов и прототипов;
- Техническая поддержка проекта;
- Защита от снятия компонента с производства.



Как с нами связаться

Телефон: 8 (812) 309 58 32 (многоканальный)

Факс: 8 (812) 320-02-42

Электронная почта: org@eplast1.ru

Адрес: 198099, г. Санкт-Петербург, ул. Калинина, дом 2, корпус 4, литера А.