

Ordering a market-ready enclosure® is made fast and affordable with our complete in-house capabilities. New Age provides machined openings to fit your PCB, pad printing for your graphics, custom enclosures, custom colors, final assembly, testing and fulfillment services to save you additional time and money. Ask your representative for a free quote today 805-595-1310.

Fast and Affordable Customization

**CNC Modifications
Pad Printing
Colored Resins
EMI/RF Shielding
Custom Enclosure
Assembly & Testing**

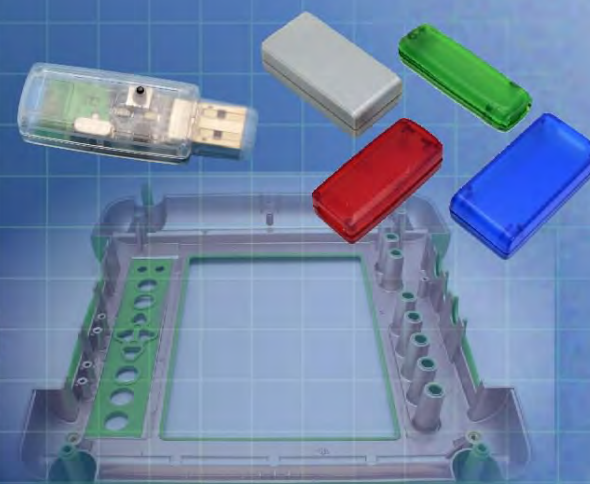

ISO quality
off-the-shelf
to market-ready®

NEW AGE ENCLOSURES

www.NewAgeEnclosures.com

4330 Santa Fe Road • San Luis Obispo, CA 93401 • T 805.595.1310 • F 805.595.1024

SXX-301210
3" DONGLE
 MOLD USING 2 SHORT ENDS
 INCLUDES 4 #4 x 3/8" ASSEMBLY SCREWS

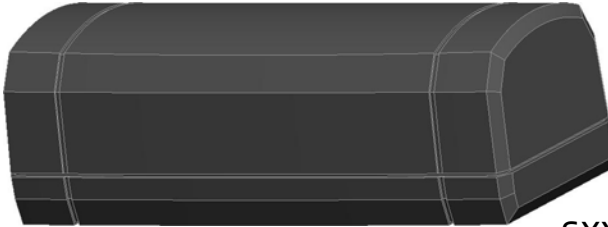

SCALE 1.000

SXX-401210
4" DONGLE
 MOLD USING 1 SHORT & 1 LONG END
 INCLUDES 4 #4 x 3/8" ASSEMBLY SCREWS

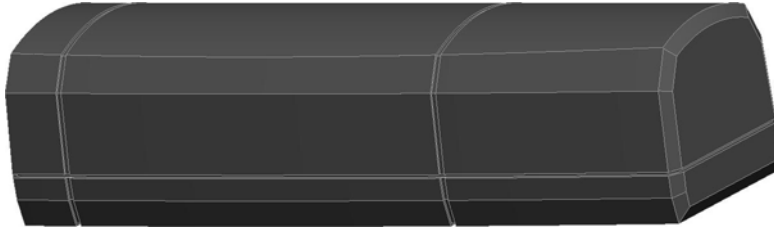

SCALE 1.000

SXX-501210
5" DONGLE
 MOLD USING 2 LONG ENDS
 INCLUDES 4 #4 x 3/8" ASSEMBLY SCREWS

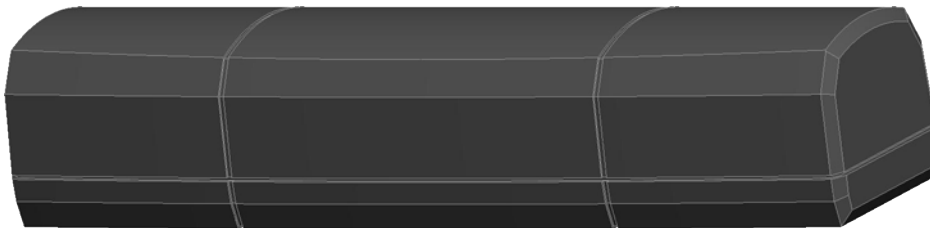

SCALE 1.000

THIS ENCLOSURE IS MOLDED WITH A "SHORT" OR "LONG" END ON EITHER HALF. THE DETAILS ON THE FOLLOWING SHEET SHOW THE 4" VERSION SINCE IT'S MOLDED WITH ONE LONG END AND ONE SHORT END.

R E V I S I O N					
REV.	DRAWN BY	ECO No	DESCRIPTION	DATE	APPROVED
1	M BOYER		PRELIMINARY RELEASE	09-Apr-08	D.C.
2	M BOYER	2408	UPDATE TO AS BUILT AND B.O.M. INFORMATION	17-Jul-08	D.C.
2.1	M BOYER	0710	UPDATE FORMAT	05-Mar-10	D.C.
3.0	M BOYER	1610	REMOVE EXTRA ASSEMBLY SCREW HOLES	01-Jun-10	D.C.
4.0	M BOYER	3110	INCREASE HEIGHT OF RETAINING RIBS ON BASE	26-Aug-10	D.C.
5.0	M BOYER	5410	INCREASE DRAFT ON END OF BASE TO 2°	14-Dec-10	D.C.
5.1	M BOYER	3712	MODIFY NOTE ON PG 5	22-Oct-12	D.C.
5.2	M BOYER	2013	UPDATE AS-BUILT TEXTURE INFORMATION	22-Apr-13	D.C.

S(X)01210 CONFIGURATIONS

	3"	4"	5"
S301210 COVER	1		
S301210 BASE	1		
S401210 COVER		1	
S401210 BASE		1	
S501210 COVER			1
S501210 BASE			1
#4 HiLo SCREW .375"	4	4	4

NOTES: UNLESS OTHERWISE SPECIFIED

- CORNERS DRAWN SHARP TO BE R.005 MAXIMUM.
- EXTERIOR SURFACE TEXTURE TO BE LIGHT EDM FINISH. EQUIVELANT TO MT-11020.
- INTERIOR SURFACE TEXTURE TO BE: NONE.
- ALL INSIDE RADII .010R. ALL OUTSIDE RADII .020R MAX, UNLESS OTHERWISE SPECIFIED.
- ALL EXTERNAL DIMENSIONS AFFECTED BY THE DRAFT APPLY AT THE LARGE END OF THE FEATURE, AND ALL INTERNAL FEATURES AFFECTED BY THE DRAFT APPLY AT THE SMALL END OF THE FEATURE UNLESS OTHERWISE SPECIFIED.
- 1 DEGREE DRAFT IN THE DIRECTION OF PULL IS PERMISSIBLE UNLESS OTHERWISE SPECIFIED.
- MATERIAL / COLOR: ABS PLASTIC IS STANDARD IN BLACK OR WHITE. CUSTOM MATERIALS AND COLORS ARE AVAILABLE UPON REQUEST FOR QUOTE.
- PCB SIZES ARE RECOMMENDATIONS ONLY. FINAL SIZES AND VERIFICATION OF IT'S FIT ARE THE SOLE RESPONSIBILITY OF EACH O.E.M.
- ASSEMBLY SCREWS FOR THE ENCLOSURE INCLUDED. MOUNTING SCREWS ARE UNNECESSARY WITH PCB CAPTURE DESIGN.
- THIS DRAWING IS BASED ON A SOLID MODEL, AND IS FURTHER DEFINED BY THE SOLID MODEL FILE.
- ALLOWABLE FLASH: 0.010 MAX.

THIRD ANGLE PROJECTION DO NOT SCALE DRAWING	TOLERANCES: UNLESS OTHERWISE SPECIFIED DIMENSIONS ARE IN U.S. INCHES. X.XX = .015 X.XXXX = .001 X.XXX = .010 X.X° = 1°	NEW AGE ENCLOSURES 4330 Santa Fe Road San Luis Obispo, CA. 93401 ph. (805) 595-1310 fax (805) 595-1024 www.newageenclosures.com
	NEW AGE ENCLOSURES Customer's Part No: (X)01210	
APPROVAL BY DATE CHECK _____ ENG. _____ SCALE _____	STANDARD - DONGLE SXX-X01210 ASSEMBLY	SHEET 1 OF 6 REV.DOC 5.2
DRAWN BY M BOYER DATE 09-Apr-08	SIZE A DRAWING NAME SX01210_RS_2	

ITEM	DESCRIPTION	MATERIAL	COLOR	QTY.
4	X01210 COVER - STANDARD	ABS	BLACK or WHITE	1
3	X01210 BASE - STANDARD	ABS	BLACK or WHITE	1
2	HiLo #4 x 3/8"	STEEL	.375" LONG	4
1	X01210 PCB	REFERENCE ONLY	.062" THICK	1

BILL OF MATERIALS

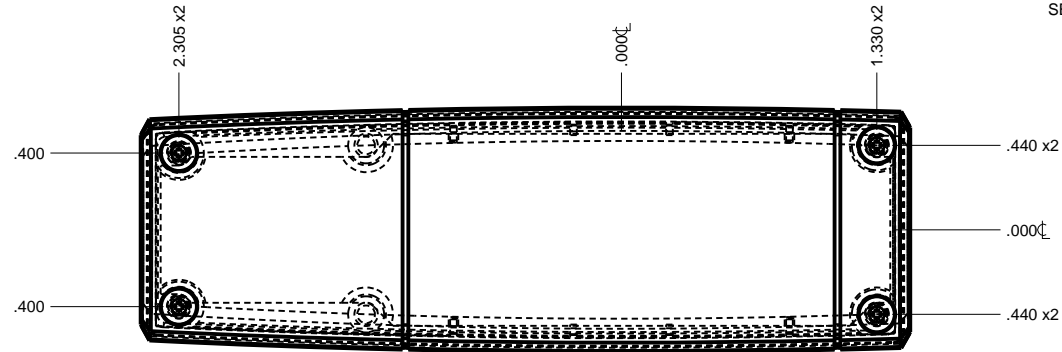
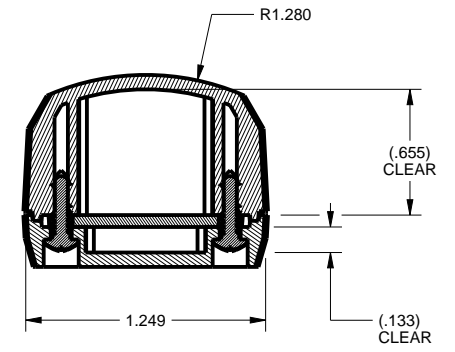
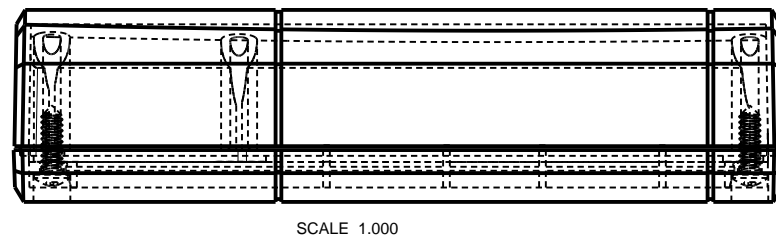
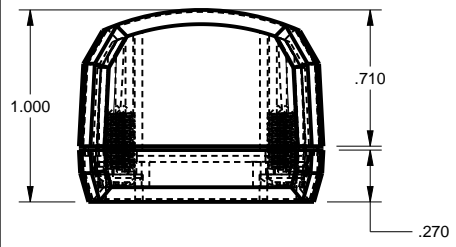
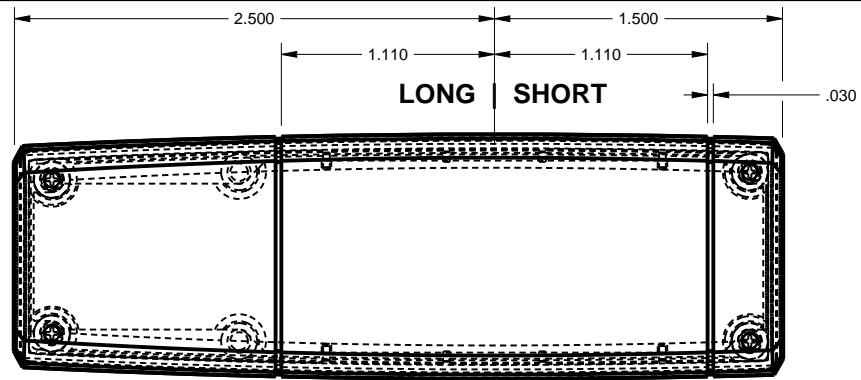

NOTE:
 4" DONGLE SHOWN TO REPRESENT
 1 LONG END & 1 SHORT END CONFIGURATION.

FOR THE 3" & 5" VERSIONS,
 MATCHING ENDS SHOULD BE USED.

TOLERANCES: UNLESS OTHERWISE SPECIFIED
 DIMENSIONS ARE IN U.S. INCHES.
 X.XX = .015 X.XXXX = .001
 X.XXX = .010 X.X° = 1°

NEW AGE ENCLOSURES
 Customer's Part No: (X)01210

APPROVAL	BY	DATE
CHECK		
ENG.		
SCALE		
DRAWN BY	09-Apr-08	
M BOYER		

NEW AGE ENCLOSURES
 4330 Santa Fe Road San Luis Obispo, CA. 93401
 ph. (805) 595-1310 fax (805) 595-1024
www.newageenclosures.com

STANDARD - DONGLE SXX-X01210 ASSEMBLY		SHEET	REV.DOC
SIZE	DRAWING NAME	2 OF 6	5.2
A	SX01210_R5_2		

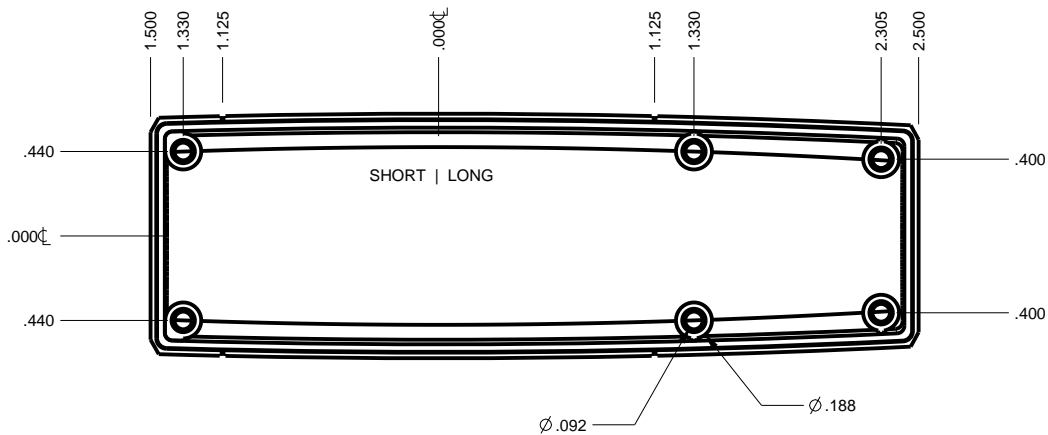
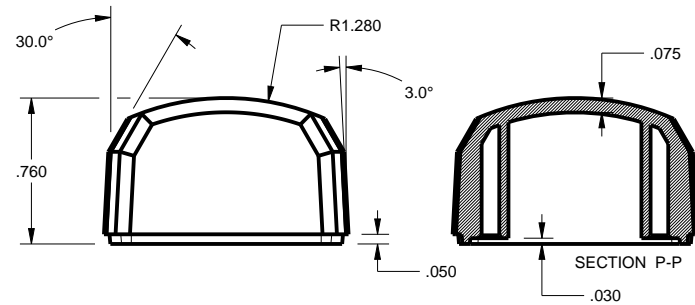
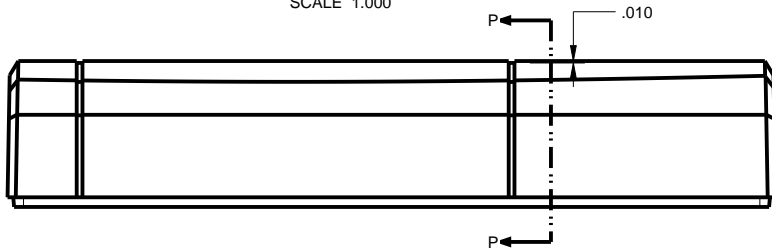
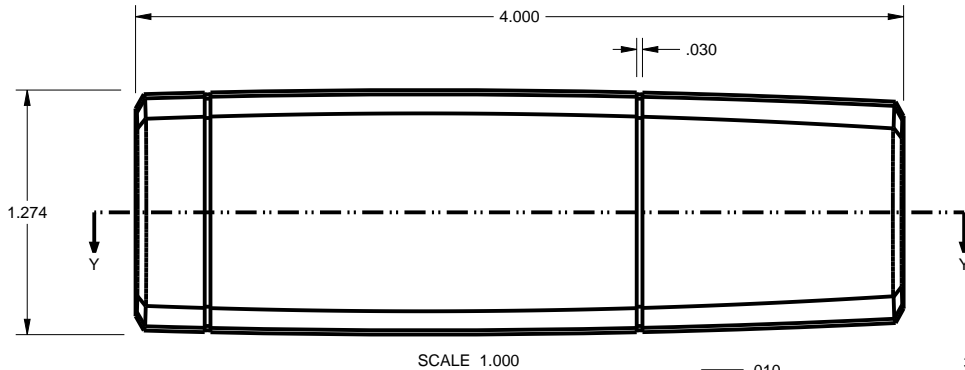
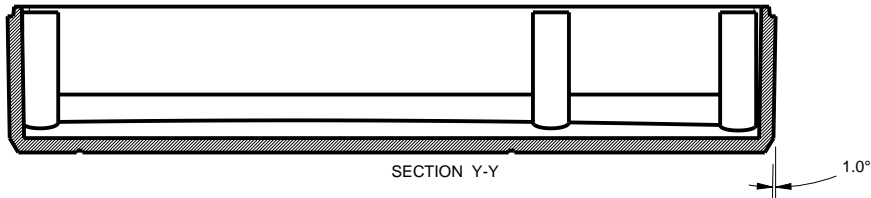

TOLERANCES: UNLESS OTHERWISE SPECIFIED
DIMENSIONS ARE IN U.S. INCHES.
X.XX = .015 X.XXXX = .001
X.XXX = .010 X.X° = 1°

NEW AGE ENCLOSURES

Customer's Part No: (X)01210

APPROVAL BY DATE

CHECK

ENG.

SCALE

DRAWN BY M BOYER 09-Apr-08

NEW AGE ENCLOSURES

4330 Santa Fe Road San Luis Obispo, CA. 93401
ph. (805) 595-1310 fax (805) 595-1024
www.newageenclosures.com

**STANDARD - DONGLE
SXX-X01210 ASSEMBLY**

SIZE A DRAWING NAME SX01210_R5_2

SHEET 3 OF 6 REV.DOC 5.2

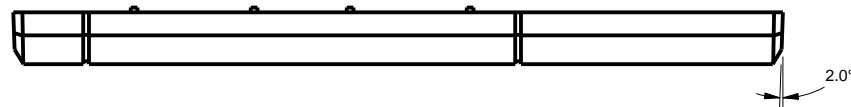
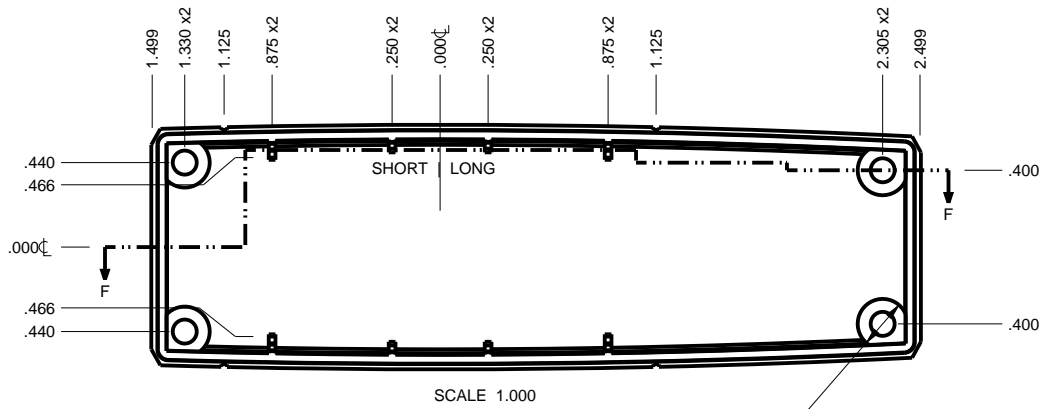
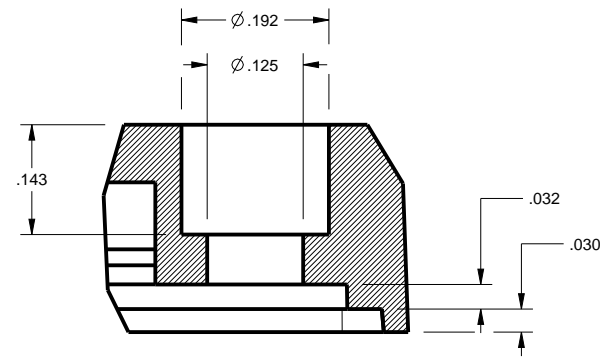
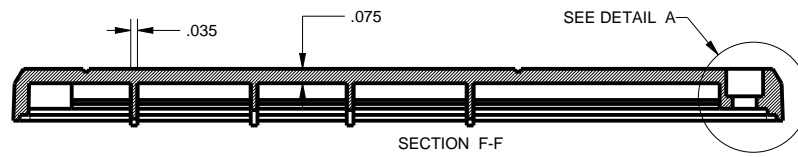
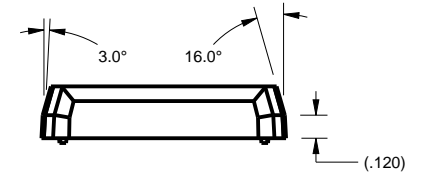
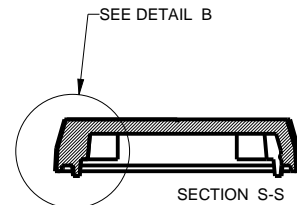
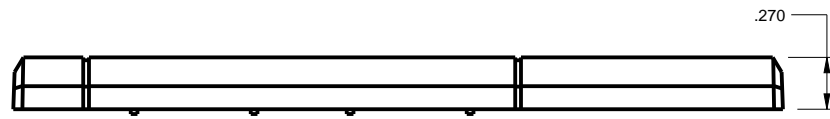
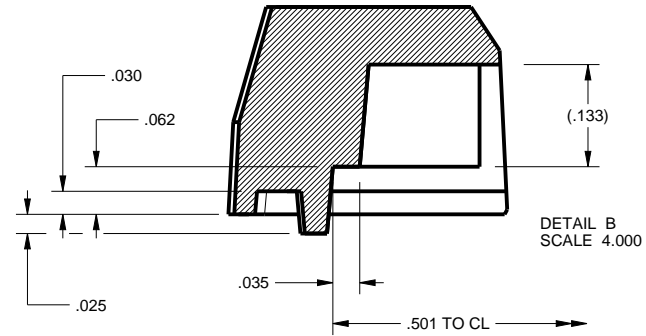
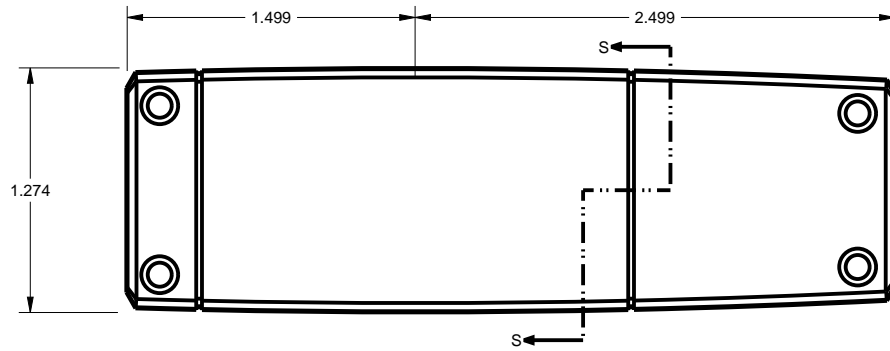

TOLERANCES: UNLESS OTHERWISE SPECIFIED DIMENSIONS ARE IN U.S. INCHES.
 X.XX = .015 X.XXXX = .001
 X.XXX = .010 X.X° = 1°

NEW AGE ENCLOSURES
 Customer's Part No: (X)01210

APPROVAL	BY	DATE
CHECK		
ENG.		
SCALE		
DRAWN BY		
M BOYER	09-Apr-08	

NEW AGE ENCLOSURES
 4330 Santa Fe Road San Luis Obispo, CA. 93401
 ph. (805) 595-1310 fax (805) 595-1024
www.newageenclosures.com

**STANDARD - DONGLE
 SXX-X01210 ASSEMBLY**

SIZE	DRAWING NAME	SHEET	REV.DOC
A	SX01210_R5_2	4 OF 6	5.2

(X)01210 PCB - CUSTOMER SUPPLIED

PCB SIZES ARE RECOMMENDATIONS ONLY. FINAL SIZES AND VERIFICATION OF IT'S FIT ARE THE SOLE RESPONSIBILITY OF THE OEM.

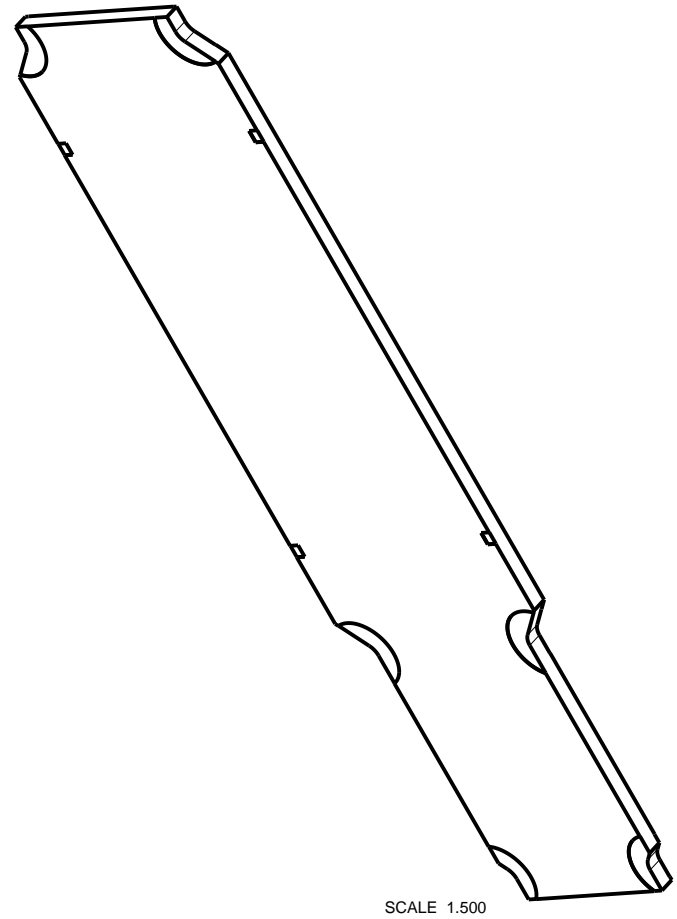
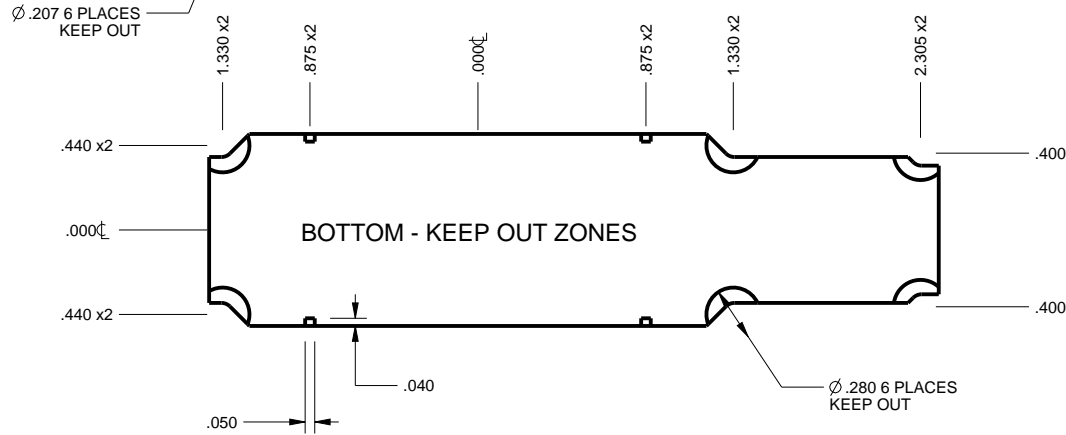
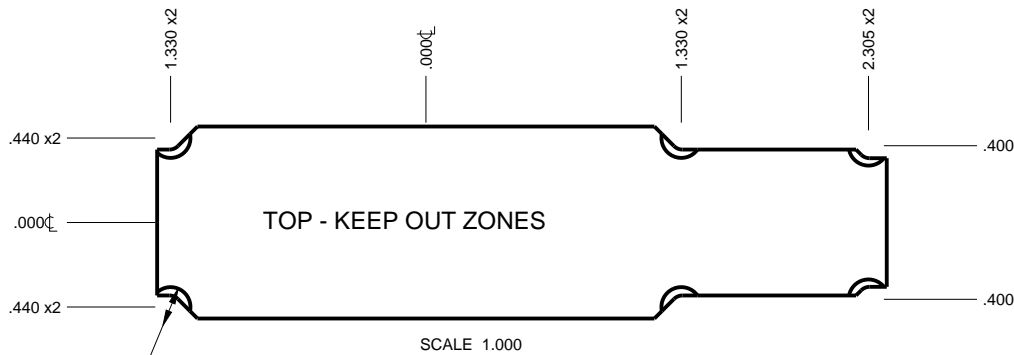
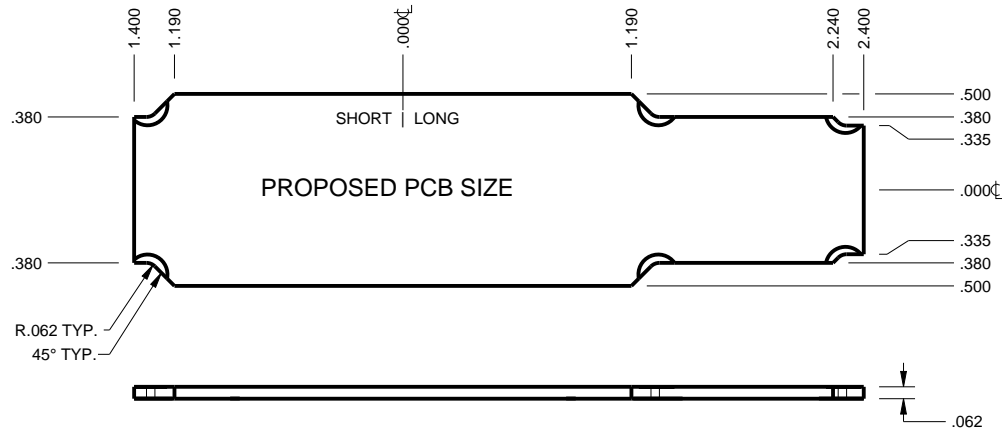

TOLERANCES: UNLESS OTHERWISE SPECIFIED DIMENSIONS ARE IN U.S. INCHES.
 X.XX = .015 X.XXXX = .001
 X.XXX = .010 X.X° = 1°

NEW AGE ENCLOSURES
 Customer's Part No: (X)01210

APPROVAL BY DATE

CHECK

ENG.

SCALE

DRAWN BY M BOYER 09-Apr-08

NEW AGE ENCLOSURES
 4330 Santa Fe Road San Luis Obispo, CA. 93401
 ph. (805) 595-1310 fax (805) 595-1024
www.newageenclosures.com

STANDARD - DONGLE
 SXX-X01210 ASSEMBLY

SIZE A DRAWING NAME SX01210_RS_2 SHEET 5 OF 6 REV.DOC 5.2

2nd OPERATION DETAILS

NEW AGE ENCLOSURES DELIVERS YOUR ENCLOSURE MARKET-READY WITH IN-HOUSE
CNC MACHINING, PAD PRINTING, ASSEMBLY, AND FULFILLMENT.
ALL SURFACES AND AREAS ARE AVAILABLE FOR CNC ALTERATION BY NEW AGE ENCLOSURES
CALL (805) 595-1310 FOR PRICING AND SCHEDULE.
THE INSIDE RADIUS OF ANY MACHINED FEATURES SHOULD BE NO SMALLER THAN .031"

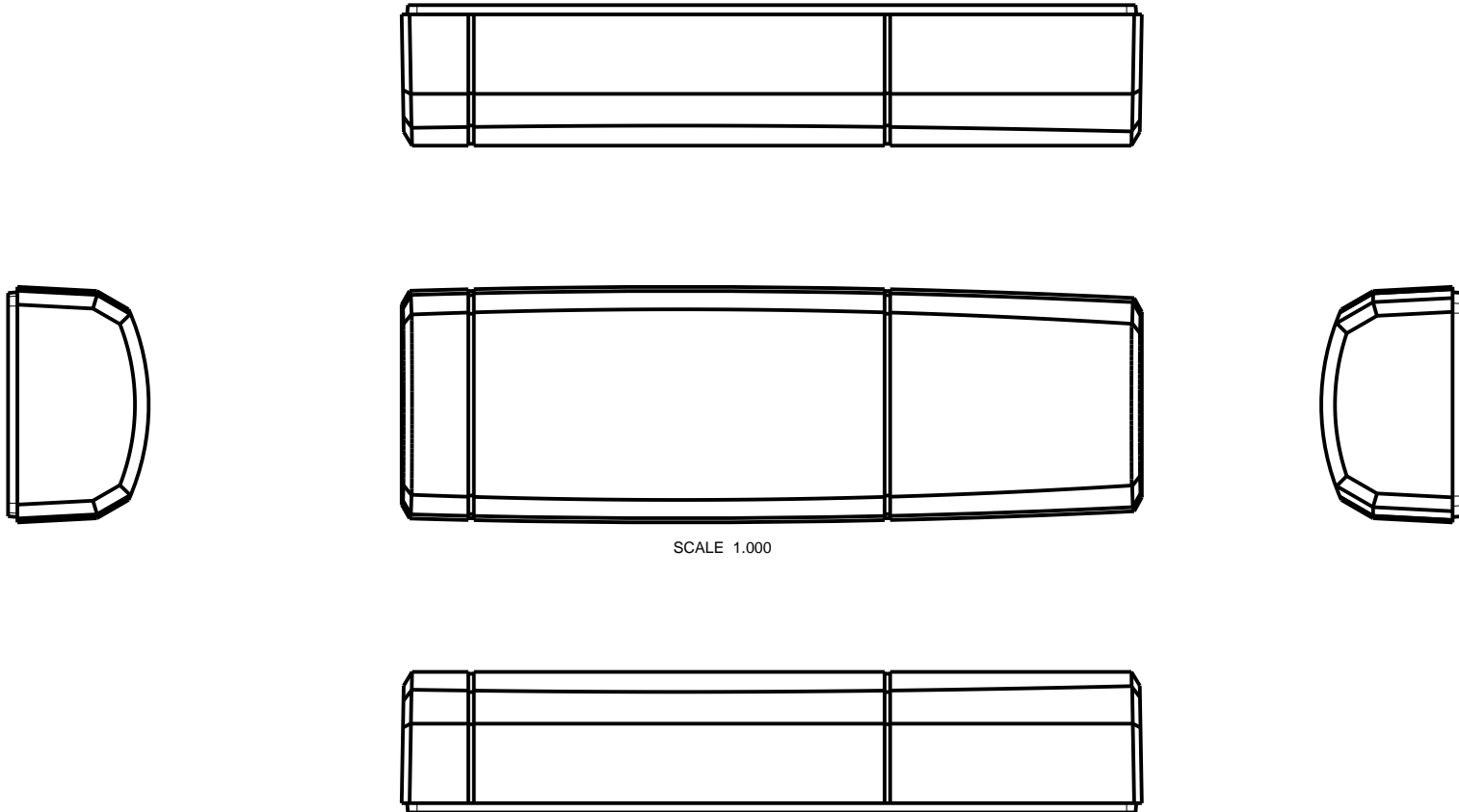

SCALE 1.000

TOLERANCES: UNLESS OTHERWISE SPECIFIED
DIMENSIONS ARE IN U.S. INCHES.
X.XX = .015 X.XXXX = .001
X.XXX = .010 X.X° = 1°

NEW AGE ENCLOSURES

Customer's Part No: (X)01210

NEW AGE ENCLOSURES

4330 Santa Fe Road San Luis Obispo, CA. 93401
ph. (805) 595-1310 fax (805) 595-1024

www.newageenclosures.com

**STANDARD - DONGLE
SXX-X01210 ASSEMBLY**

SXX-X01210-XXX COVER - ABS, BLACK					
STEP NO	DESCRIPTION	CUTTER	FIXTURE	ORIENTATION	PROGRAM
1	-	T2 = .062" EM	178	-	
2	-	T2 = .062" EM	178	-	
3	-	T2 = .062" EM	178	-	

APPROVAL	BY	DATE
CHECK		
ENG.		
SCALE		
DRAWN BY		
M BOYER	09-Apr-08	

SIZE	DRAWING NAME	SHEET	REV.DOC
A	SX01210_R5_2	6 OF 6	5.2

Mouser Electronics

Authorized Distributor

Click to View Pricing, Inventory, Delivery & Lifecycle Information:

[New Age Enclosures:](#)

[S3A-301210](#) [S1A-501210](#) [S1A-301210](#) [S3A-501210](#) [S3A-401210](#) [S1A-401210](#)



Компания «ЭлектроПласт» предлагает заключение долгосрочных отношений при поставках импортных электронных компонентов на взаимовыгодных условиях!

Наши преимущества:

- Оперативные поставки широкого спектра электронных компонентов отечественного и импортного производства напрямую от производителей и с крупнейших мировых складов;
- Поставка более 17-ти миллионов наименований электронных компонентов;
- Поставка сложных, дефицитных, либо снятых с производства позиций;
- Оперативные сроки поставки под заказ (от 5 рабочих дней);
- Экспресс доставка в любую точку России;
- Техническая поддержка проекта, помощь в подборе аналогов, поставка прототипов;
- Система менеджмента качества сертифицирована по Международному стандарту ISO 9001;
- Лицензия ФСБ на осуществление работ с использованием сведений, составляющих государственную тайну;
- Поставка специализированных компонентов (Xilinx, Altera, Analog Devices, Intersil, Interpoint, Microsemi, Aeroflex, Peregrine, Syfer, Eurofarad, Texas Instrument, Miteq, Cobham, E2V, MA-COM, Hittite, Mini-Circuits, General Dynamics и др.);

Помимо этого, одним из направлений компании «ЭлектроПласт» является направление «Источники питания». Мы предлагаем Вам помощь Конструкторского отдела:

- Подбор оптимального решения, техническое обоснование при выборе компонента;
- Подбор аналогов;
- Консультации по применению компонента;
- Поставка образцов и прототипов;
- Техническая поддержка проекта;
- Защита от снятия компонента с производства.



Как с нами связаться

Телефон: 8 (812) 309 58 32 (многоканальный)

Факс: 8 (812) 320-02-42

Электронная почта: org@eplast1.ru

Адрес: 198099, г. Санкт-Петербург, ул. Калинина, дом 2, корпус 4, литера А.