

*RoHS COMPLIANT



BOURNS®

Features

- Conductive plastic technology
- Low profile package
- 50,000 cycle rotational life
- Available with momentary push or rotary switch option
- PCB mount terminal configuration
- Rugged metal housing for industrial applications
- Flatted or slotted shaft options
- RoHS compliant*

39 – 13 mm Single-Turn Panel Control with Switch Option

Electrical Characteristics

| | |
|--|---------------------|
| Standard Resistance Range..... | 5 K - 100 K ohms |
| Total Resistance Tolerance..... | ±20 % |
| Independent Linearity..... | ±5 % |
| End Resistance..... | 2 ohms maximum |
| Effective Electrical Angle | |
| Non-Switch Type (Bushing Type "S") | 220 ° ± 5 ° |
| Rotary Switch Type (Bushing Type "S") | 220 ° ± 5 ° |
| Momentary Push Switch Type (Bushing Type "L") | 201 ° ± 5 % |
| Contact Resistance Variation | 3 % maximum |
| Dielectric Withstanding Voltage (MIL-STD-202, Method 301) | |
| Sea Level | 750 VRMS minimum |
| Insulation Resistance | 100 megohms minimum |
| Power Rating @ 70 °C (Derated to 0 @ 125 °C) | |
| (Voltage Limited by Power Dissipation or 350 VAC, whichever is less) | |
| Linear Taper | 0.25 watt |
| Audio Taper | 0.125 watt |

Switch Characteristics

| | |
|--|----------------------------------|
| Rotary Switch Type..... | SPST N.O. |
| Power Rating (Resistive Load) | 1.5 amps @ 12 VDC |
| Contact Resistance @ 10 mA | 200 milliohms maximum |
| Contact Bounce..... | 5 milliseconds |
| Actuation Torque..... | 0.7 to 4.9 N-cm (1 to 7 oz.-in.) |
| Momentary Push Switch Type..... | SPST N.O. |
| Power Rating (Resistive Load) | 250 milliamps @ 12 VDC |
| Contact Resistance @ 10 mA (w/500 gm Shaft Load) | 50 ohms maximum |
| Contact Bounce..... | 5 milliseconds |
| Actuation Force | 500 ± 100 gram |

Environmental Characteristics

| | |
|-----------------------------------|--------------------------------------|
| Operating Temperature Range | -40 °C to +85 °C (-40 °F to +185 °F) |
| Storage Temperature Range | -55 °C to +85 °C (-67 °F to +185 °F) |
| Vibration | 15 G |
| Total Resistance Shift | ±3 % |
| Voltage Ratio Shift | ±5 % |
| Shock | 30 G |
| Total Resistance Shift | ±3 % |
| Voltage Ratio Shift | ±5 % |
| Load Life..... | 1,000 Hours |
| Total Resistance Shift | ±10 % |
| Rotational Life (No Load)..... | 50,000 cycles |
| Total Resistance Shift | ±10 % |
| Switch Life | |
| Rotary Switch Type..... | 25,000 cycles |
| Momentary Push Switch Type | 50,000 cycles |
| Moisture Resistance..... | MIL-STD-202, Method 103, Condition B |
| Total Resistance Shift | ±10 % |
| IP Rating | IP 40 |

Mechanical Characteristics

| | |
|--|---|
| Stop Strength | 19.8 N-cm (28 oz.-in.) |
| Mechanical Angle | |
| Non-Switch and Rotary Switch Type..... | 270 ° ± 10 ° |
| Momentary Push Switch Type | 230 ° ± 10 ° |
| Torque | |
| Starting | 0.07 to 0.70 N-cm (0.1 to 1.0 oz.-in.) minimum |
| Running..... | 0.07 to 0.53 N-cm (0.1 to 0.75 oz.-in.) maximum |
| Mounting..... | 1.7 to 2.0 N-m (15 to 18 lbs.-in.) maximum |
| Shaft Retention | |
| Pull Force..... | 4 Kg (8.8 lb.) maximum |
| Push Force..... | 4.5 Kg (10 lb.) maximum |
| Weight (Single Section)..... | 4 grams (0.14 oz.) |
| Terminals | |
| Potentiometer | Printed circuit board terminals |
| Switch..... | Flat terminals |
| Soldering Condition | |
| Manual Soldering..... | 96.5Sn/3.0Ag/0.5Cu solid wire or no-clean rosin cored wire; 370 °C (700 °F) max. for 3 seconds |
| Wave Soldering..... | 96.5Sn/3.0Ag/0.5Cu solder with no-clean flux; 260 °C (500 °F) max. for 5 seconds |
| Wash processes | Not recommended |
| Marking..... | Manufacturer's trademark, part number and date code |
| Ganging..... | 1 cup maximum |
| Hardware..... | One lockwasher and one mounting nut is shipped with each potentiometer, except where noted in the part number |
| Packaging..... | 100 pcs./tray |

*RoHS Directive 2002/95/EC Jan. 27, 2003 including annex and RoHS Recast 2011/65/EU June 8, 2011. Specifications are subject to change without notice.

The device characteristics and parameters in this data sheet can and do vary in different applications and actual device performance may vary over time. Users should verify actual device performance in their specific applications.

39 - 13 mm Single-Turn Panel Control with Switch Option

BOURNS®

Product Dimensions

BUSHING STYLE "L"

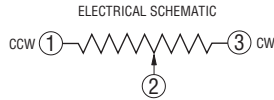
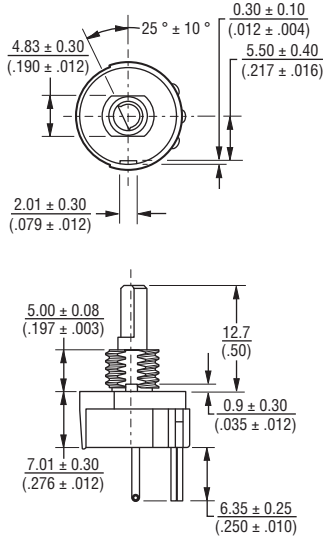

BOTTOM VIEW

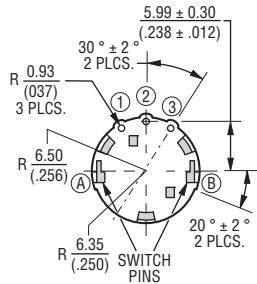

BUSHING STYLE "S"

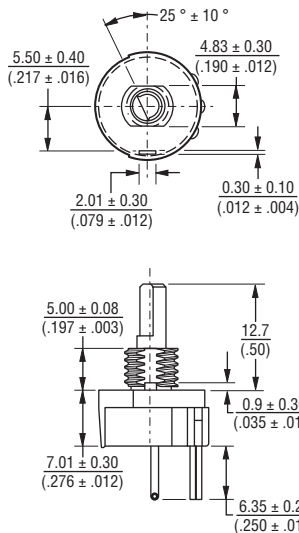

BOARD LAYOUT

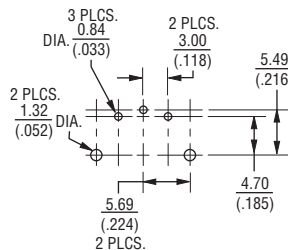

SHAFT STYLE "A"

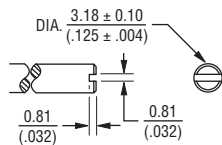

SHAFT STYLE "B"

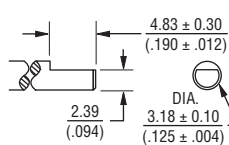

How To Order

39 S B - 1 R B - 503

SWITCH TYPE

| Code | Description |
|------|----------------|
| N | No Switch |
| P | Momentary Push |
| R | Rotary Switch |

TERMINAL CONFIGURATION

| Code | Description |
|------|-----------------|
| 1 | 6.35 mm (.250") |

SHAFT TYPE (SEE SHAFT STYLE FIGURES)

| Code | Description |
|------|--|
| A | Slotted Shaft, Dia. 3.175 mm (1/8") x 12.7 mm (1/2") FMS |
| B | Flatted Shaft, Dia. 3.175 mm (1/8") x 12.7 mm (1/2") FMS |

BUSHING TYPE (SEE BUSHING STYLE FIGURES)

| Code | Description | EFFECTIVE ELECTRICAL ANGLE | AVAILABLE ONLY IN SWITCH TYPE |
|------|----------------------------------|----------------------------|-------------------------------|
| L | 1/4-28-UNF-2A x 5 mm (.197") FMS | 201 | P |
| S | 1/4-28-UNF-2A x 5 mm (.197") FMS | 220 | R & N |

MODEL NUMBER

| Code | Description |
|------|-------------|
| 39 | Model 39 |

ELEMENT TAPER

| Code | Description |
|------|---------------------|
| B | Linear C.P. 20 % |
| D | CW Audio C.P. 20 % |
| G | CCW Audio C.P. 20 % |

RESISTANCE CODE 20 %

| Code | Description |
|------|-----------------|
| 502 | 5 K Ohms (13) |
| 103 | 10 K Ohms (15) |
| 203 | 20 K Ohms (16) |
| 253 | 25 K Ohms (17) |
| 503 | 50 K Ohms (18) |
| 104 | 100 K Ohms (20) |

DIMENSIONS: $\frac{\text{MM}}{\text{(INCHES)}}$

TOLERANCES EXCEPT AS SHOWN:
 .XX $\frac{0.13}{(.005)}$.X $\frac{0.38}{(.015)}$

REV. 03/13

Specifications are subject to change without notice.

The device characteristics and parameters in this data sheet can and do vary in different applications and actual device performance may vary over time. Users should verify actual device performance in their specific applications.



Компания «ЭлектроПласт» предлагает заключение долгосрочных отношений при поставках импортных электронных компонентов на взаимовыгодных условиях!

Наши преимущества:

- Оперативные поставки широкого спектра электронных компонентов отечественного и импортного производства напрямую от производителей и с крупнейших мировых складов;
- Поставка более 17-ти миллионов наименований электронных компонентов;
- Поставка сложных, дефицитных, либо снятых с производства позиций;
- Оперативные сроки поставки под заказ (от 5 рабочих дней);
- Экспресс доставка в любую точку России;
- Техническая поддержка проекта, помощь в подборе аналогов, поставка прототипов;
- Система менеджмента качества сертифицирована по Международному стандарту ISO 9001;
- Лицензия ФСБ на осуществление работ с использованием сведений, составляющих государственную тайну;
- Поставка специализированных компонентов (Xilinx, Altera, Analog Devices, Intersil, Interpoint, Microsemi, Aeroflex, Peregrine, Syfer, Eurofarad, Texas Instrument, Miteq, Cobham, E2V, MA-COM, Hittite, Mini-Circuits, General Dynamics и др.);

Помимо этого, одним из направлений компании «ЭлектроПласт» является направление «Источники питания». Мы предлагаем Вам помощь Конструкторского отдела:

- Подбор оптимального решения, техническое обоснование при выборе компонента;
- Подбор аналогов;
- Консультации по применению компонента;
- Поставка образцов и прототипов;
- Техническая поддержка проекта;
- Защита от снятия компонента с производства.



Как с нами связаться

Телефон: 8 (812) 309 58 32 (многоканальный)

Факс: 8 (812) 320-02-42

Электронная почта: org@eplast1.ru

Адрес: 198099, г. Санкт-Петербург, ул. Калинина, дом 2, корпус 4, литера А.