

## N-channel 600 V, 0.78 $\Omega$ typ., 6 A MDmesh™ DM2 Power MOSFET in a TO-220FP package

Datasheet - production data

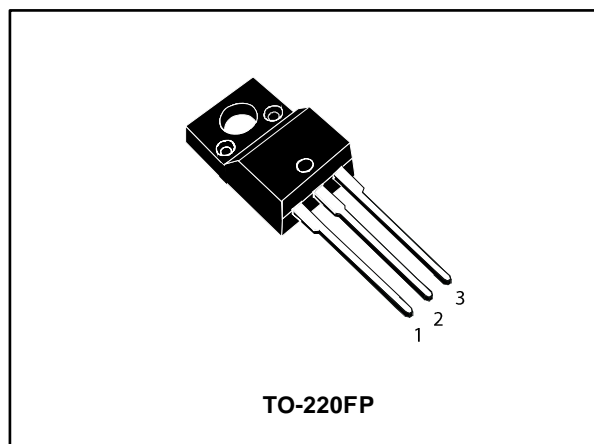
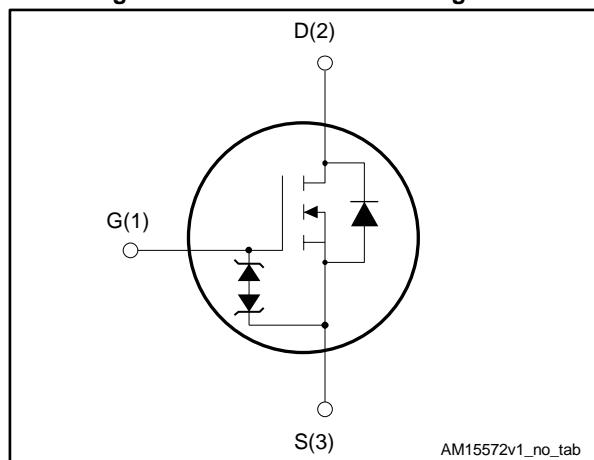

Figure 1: Internal schematic diagram



### Features

Order code	V <sub>DS</sub>	R <sub>DS(on)</sub> max.	I <sub>D</sub>	P <sub>TOT</sub>
STF7N60DM2	600 V	0.90 $\Omega$	6 A	25 W

- Fast-recovery body diode
- Extremely low gate charge and input capacitance
- Low on-resistance
- 100% avalanche tested
- Extremely high dv/dt ruggedness
- Zener-protected

### Applications

- Switching applications

### Description

This high voltage N-channel Power MOSFET is part of the MDmesh™ DM2 fast recovery diode series. It offers very low recovery charge ( $Q_{rr}$ ) and time ( $t_{rr}$ ) combined with low  $R_{DS(on)}$ , rendering it suitable for the most demanding high efficiency converters and ideal for bridge topologies and ZVS phase-shift converters.

Table 1: Device summary

Order code	Marking	Package	Packing
STF7N60DM2	7N60DM2	TO-220FP	Tube

---

## Contents

<b>1</b>	<b>Electrical ratings .....</b>	<b>3</b>
<b>2</b>	<b>Electrical characteristics .....</b>	<b>4</b>
	2.1 Electrical characteristics (curves) .....	6
<b>3</b>	<b>Test circuits .....</b>	<b>8</b>
<b>4</b>	<b>Package information .....</b>	<b>9</b>
	4.1 TO-220FP package information .....	10
<b>5</b>	<b>Revision history .....</b>	<b>12</b>

# 1 Electrical ratings

**Table 2: Absolute maximum ratings**

Symbol	Parameter	Value	Unit
V <sub>GS</sub>	Gate-source voltage	±25	V
I <sub>D</sub>	Drain current (continuous) at T <sub>case</sub> = 25 °C	6	A
	Drain current (continuous) at T <sub>case</sub> = 100 °C	3.8	
I <sub>DM</sub> <sup>(1)</sup>	Drain current (pulsed)	24	A
P <sub>TOT</sub>	Total dissipation at T <sub>case</sub> = 25 °C	25	W
dv/dt <sup>(2)</sup>	Peak diode recovery voltage slope	50	V/ns
dv/dt <sup>(3)</sup>	MOSFET dv/dt ruggedness	50	
V <sub>ISO</sub>	Insulation withstand voltage (RMS) from all three leads to external heat sink (t = 1 s; T <sub>C</sub> = 25 °C)	2.5	kV
T <sub>stg</sub>	Storage temperature range	-55 to 150	°C
T <sub>j</sub>	Operating junction temperature range		

**Notes:**

- (1) Pulse width is limited by safe operating area.  
 (2) I<sub>SD</sub> ≤ 6 A, di/dt=900 A/μs; V<sub>DS</sub> peak < V<sub>(BR)DSS</sub>, V<sub>DD</sub> = 480 V.  
 (3) V<sub>DS</sub> ≤ 480 V.

**Table 3: Thermal data**

Symbol	Parameter	Value	Unit
R <sub>thj-case</sub>	Thermal resistance junction-case	5	°C/W
R <sub>thj-amb</sub>	Thermal resistance junction-amb	62.5	

**Table 4: Avalanche characteristics**

Symbol	Parameter	Value	Unit
I <sub>AR</sub> <sup>(1)</sup>	Avalanche current, repetitive or not repetitive	1.5	A
E <sub>AS</sub> <sup>(2)</sup>	Single pulse avalanche energy	160	mJ

**Notes:**

- (1) Pulse width limited by T<sub>jmax</sub>.  
 (2) Starting T<sub>j</sub> = 25 °C, I<sub>D</sub> = I<sub>AR</sub>, V<sub>DD</sub> = 50 V.

## 2 Electrical characteristics

( $T_{\text{case}} = 25\text{ °C}$  unless otherwise specified)

**Table 5: Static**

Symbol	Parameter	Test conditions	Min.	Typ.	Max.	Unit
$V_{(\text{BR})\text{DSS}}$	Drain-source breakdown voltage	$V_{\text{GS}} = 0\text{ V}$ , $I_{\text{D}} = 1\text{ mA}$	600			V
$I_{\text{DSS}}$	Zero gate voltage drain current	$V_{\text{GS}} = 0\text{ V}$ , $V_{\text{DS}} = 600\text{ V}$			1	$\mu\text{A}$
		$V_{\text{GS}} = 0\text{ V}$ , $V_{\text{DS}} = 600\text{ V}$ , $T_{\text{case}} = 125\text{ °C}$ <sup>(1)</sup>			100	
$I_{\text{GSS}}$	Gate-body leakage current	$V_{\text{DS}} = 0\text{ V}$ , $V_{\text{GS}} = \pm 25\text{ V}$			$\pm 5$	$\mu\text{A}$
$V_{\text{GS(th)}}$	Gate threshold voltage	$V_{\text{DS}} = V_{\text{GS}}$ , $I_{\text{D}} = 250\text{ }\mu\text{A}$	3.25	4	4.75	V
$R_{\text{DS(on)}}$	Static drain-source on-resistance	$V_{\text{GS}} = 10\text{ V}$ , $I_{\text{D}} = 3\text{ A}$		0.78	0.90	$\Omega$

**Notes:**

<sup>(1)</sup>Defined by design, not subject to production test.

**Table 6: Dynamic**

Symbol	Parameter	Test conditions	Min.	Typ.	Max.	Unit
$C_{\text{ISS}}$	Input capacitance	$V_{\text{DS}} = 100\text{ V}$ , $f = 1\text{ MHz}$ , $V_{\text{GS}} = 0\text{ V}$	-	324	-	$\text{pF}$
$C_{\text{OSS}}$	Output capacitance		-	18	-	
$C_{\text{RSS}}$	Reverse transfer capacitance		-	2	-	
$C_{\text{OSS eq.}}^{(1)}$	Equivalent output capacitance	$V_{\text{DS}} = 0\text{ to }480\text{ V}$ , $V_{\text{GS}} = 0\text{ V}$	-	25	-	$\text{pF}$
$R_{\text{G}}$	Intrinsic gate resistance	$f = 1\text{ MHz}$ , $I_{\text{D}} = 0\text{ A}$	-	6	-	$\Omega$
$Q_{\text{g}}$	Total gate charge	$V_{\text{DD}} = 480\text{ V}$ , $I_{\text{D}} = 6\text{ A}$ , $V_{\text{GS}} = 0\text{ to }10\text{ V}$ (see <a href="#">Figure 15: "Test circuit for gate charge behavior"</a> )	-	7.5	-	$\text{nC}$
$Q_{\text{gs}}$	Gate-source charge		-	2.2	-	
$Q_{\text{gd}}$	Gate-drain charge		-	3.2	-	

**Notes:**

<sup>(1)</sup>  $C_{\text{OSS eq.}}$  is defined as a constant equivalent capacitance giving the same charging time as  $C_{\text{OSS}}$  when  $V_{\text{DS}}$  increases from 0 to 80%  $V_{\text{DSS}}$ .

**Table 7: Switching times**

Symbol	Parameter	Test conditions	Min.	Typ.	Max.	Unit
$t_{\text{d(on)}}$	Turn-on delay time	$V_{\text{DD}} = 300\text{ V}$ , $I_{\text{D}} = 3\text{ A}$ $R_{\text{G}} = 4.7\text{ }\Omega$ , $V_{\text{GS}} = 10\text{ V}$ (see <a href="#">Figure 14: "Test circuit for resistive load switching times"</a> and <a href="#">Figure 19: "Switching time waveform"</a> )	-	10	-	$\text{ns}$
$t_{\text{r}}$	Rise time		-	6	-	
$t_{\text{d(off)}}$	Turn-off delay time		-	12.6	-	
$t_{\text{f}}$	Fall time		-	22.6	-	

Table 8: Source-drain diode

Symbol	Parameter	Test conditions	Min.	Typ.	Max.	Unit
$I_{SD}$	Source-drain current		-		6	A
$I_{SDM}^{(1)}$	Source-drain current (pulsed)		-		24	A
$V_{SD}^{(2)}$	Forward on voltage	$V_{GS} = 0\text{ V}$ , $I_{SD} = 6\text{ A}$	-		1.6	V
$t_{rr}$	Reverse recovery time	$I_{SD} = 6\text{ A}$ , $di/dt = 100\text{ A}/\mu\text{s}$ , $V_{DD} = 60\text{ V}$ (see <a href="#">Figure 16: "Test circuit for inductive load switching and diode recovery times"</a> )	-	69		ns
$Q_{rr}$	Reverse recovery charge		-	164		nC
$I_{RRM}$	Reverse recovery current		-	4.8		A
$t_{rr}$	Reverse recovery time	$I_{SD} = 6\text{ A}$ , $di/dt = 100\text{ A}/\mu\text{s}$ , $V_{DD} = 60\text{ V}$ , $T_j = 150\text{ }^\circ\text{C}$ (see <a href="#">Figure 16: "Test circuit for inductive load switching and diode recovery times"</a> )	-	144		ns
$Q_{rr}$	Reverse recovery charge		-	492		nC
$I_{RRM}$	Reverse recovery current		-	6.8		A

**Notes:**

- (1) Pulse width is limited by safe operating area.  
(2) Pulse test: pulse duration = 300  $\mu\text{s}$ , duty cycle 1.5%.

## 2.1 Electrical characteristics (curves)

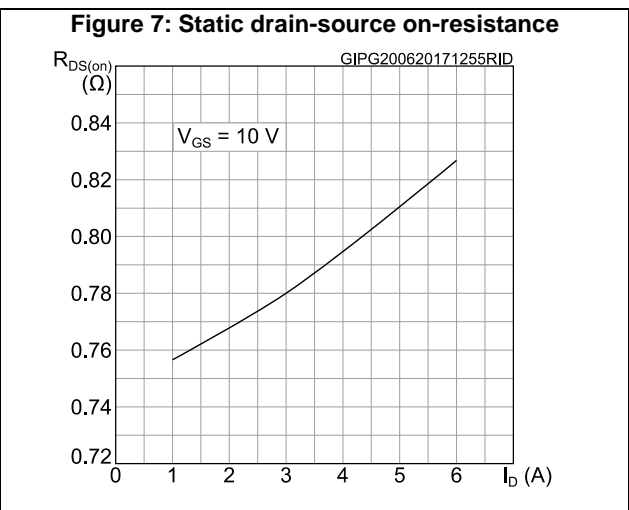
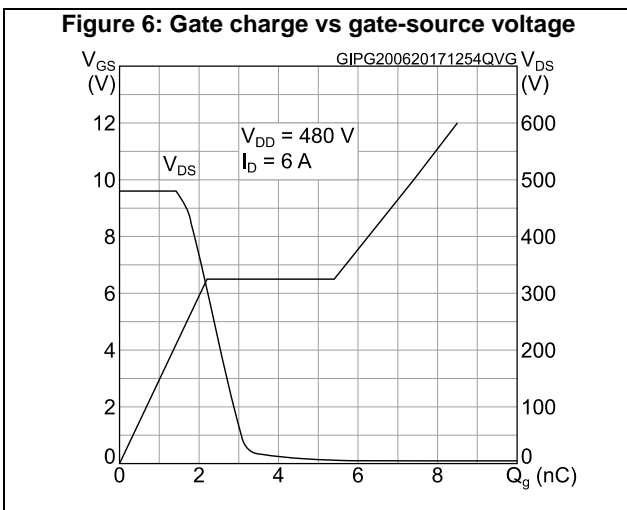
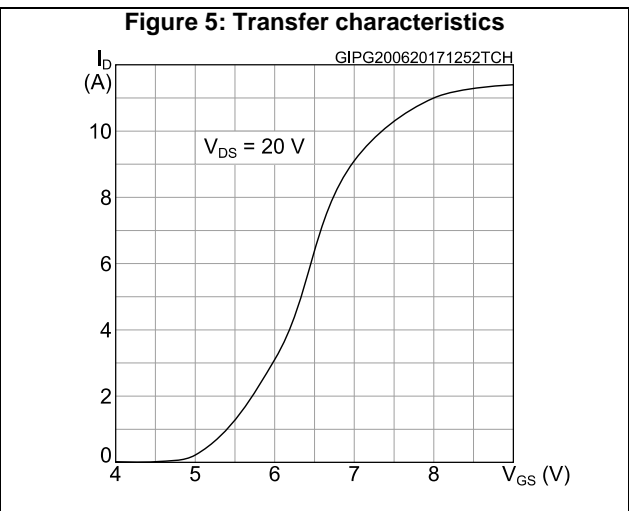
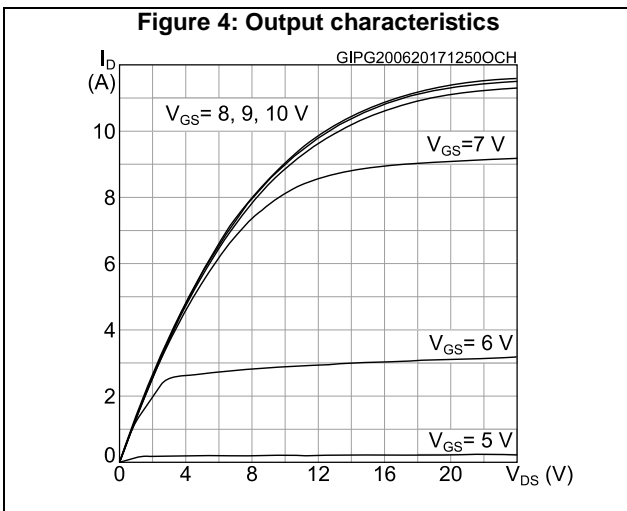
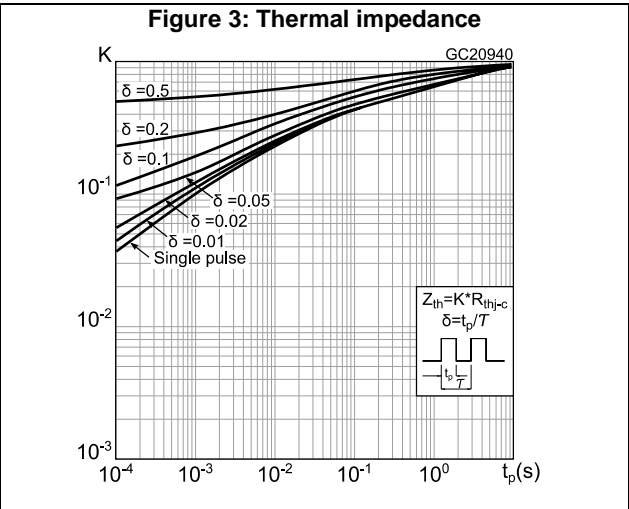
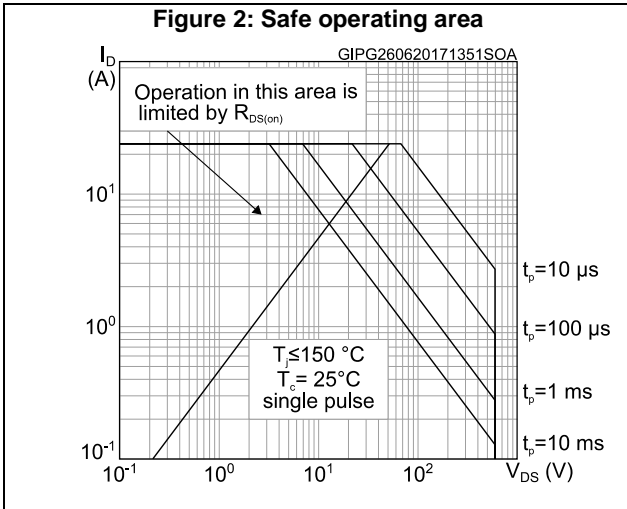

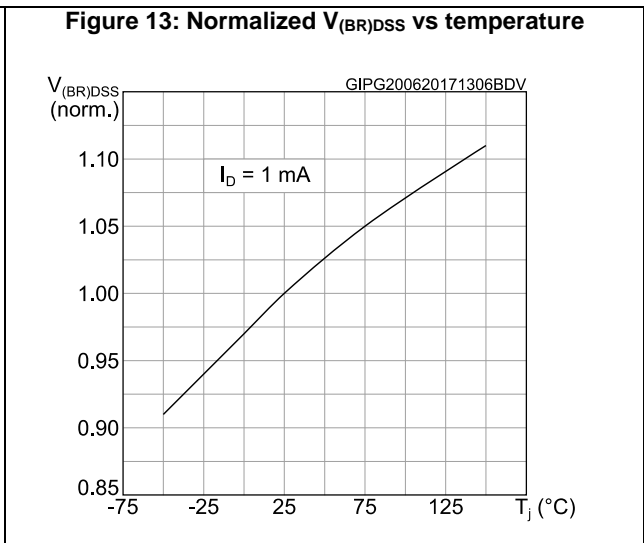
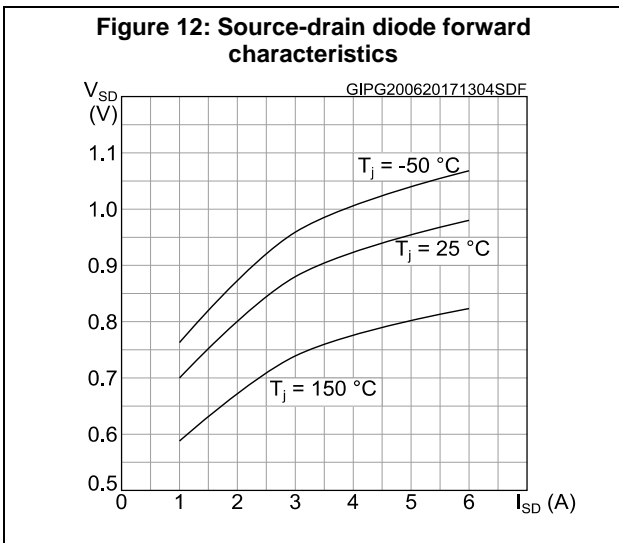
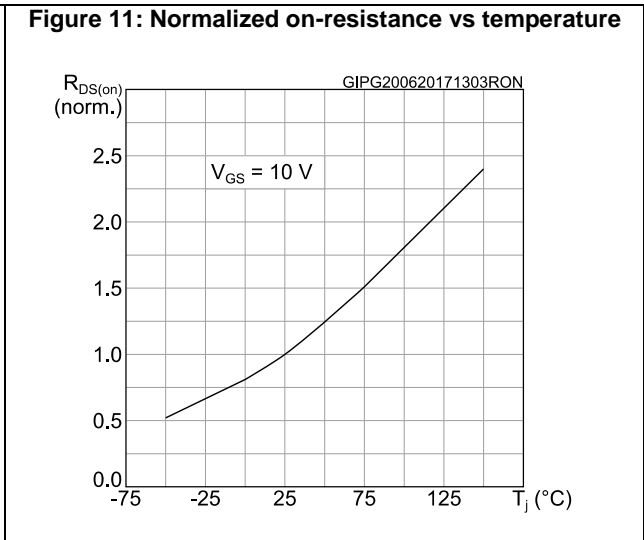
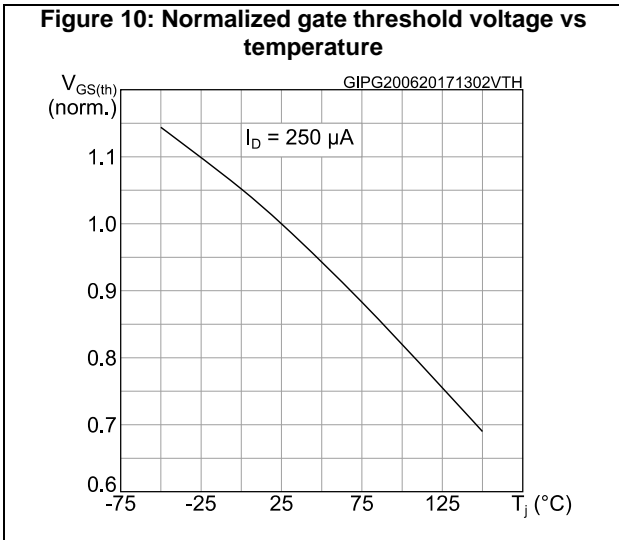
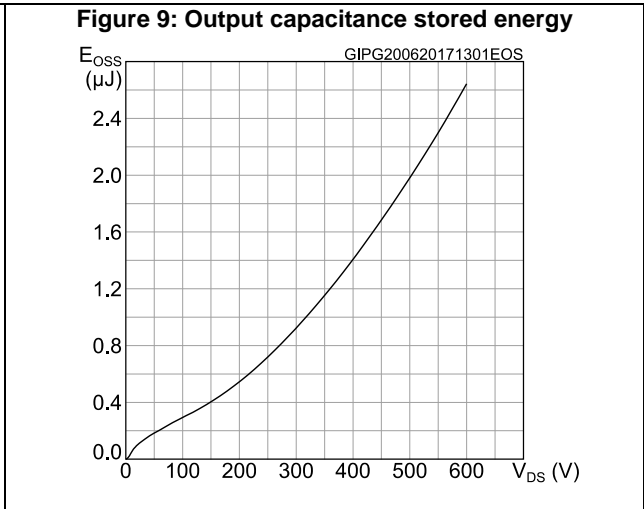
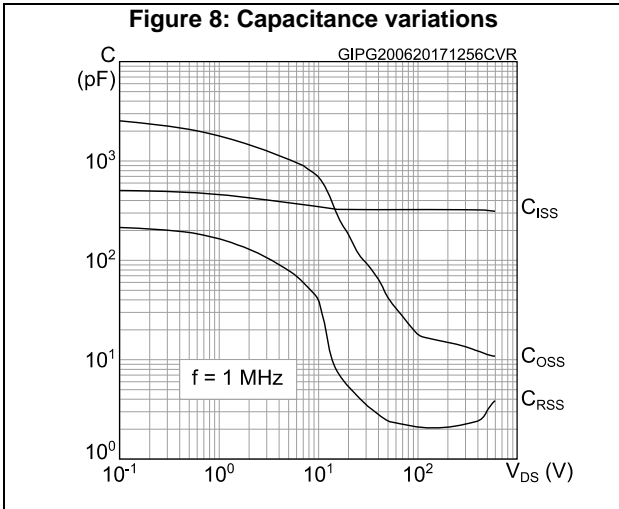

### 3 Test circuits

**Figure 14: Test circuit for resistive load switching times**



AM01468v1

**Figure 15: Test circuit for gate charge behavior**



AM01469v1

**Figure 16: Test circuit for inductive load switching and diode recovery times**



AM01470v1

**Figure 17: Unclamped inductive load test circuit**

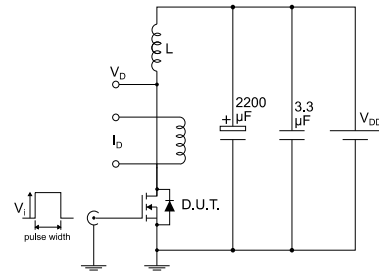

AM01471v1

**Figure 18: Unclamped inductive waveform**

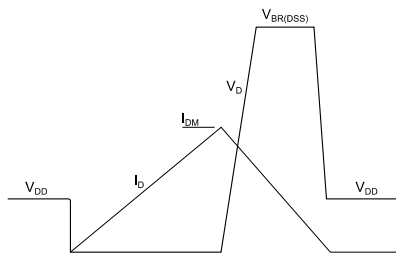

AM01472v1

**Figure 19: Switching time waveform**

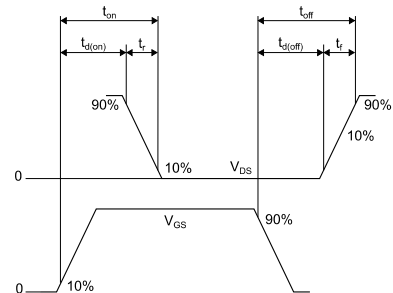

AM01473v1



## 4 Package information

In order to meet environmental requirements, ST offers these devices in different grades of ECOPACK® packages, depending on their level of environmental compliance. ECOPACK® specifications, grade definitions and product status are available at: [www.st.com](http://www.st.com). ECOPACK® is an ST trademark.

4.1 TO-220FP package information

Figure 20: TO-220FP package outline

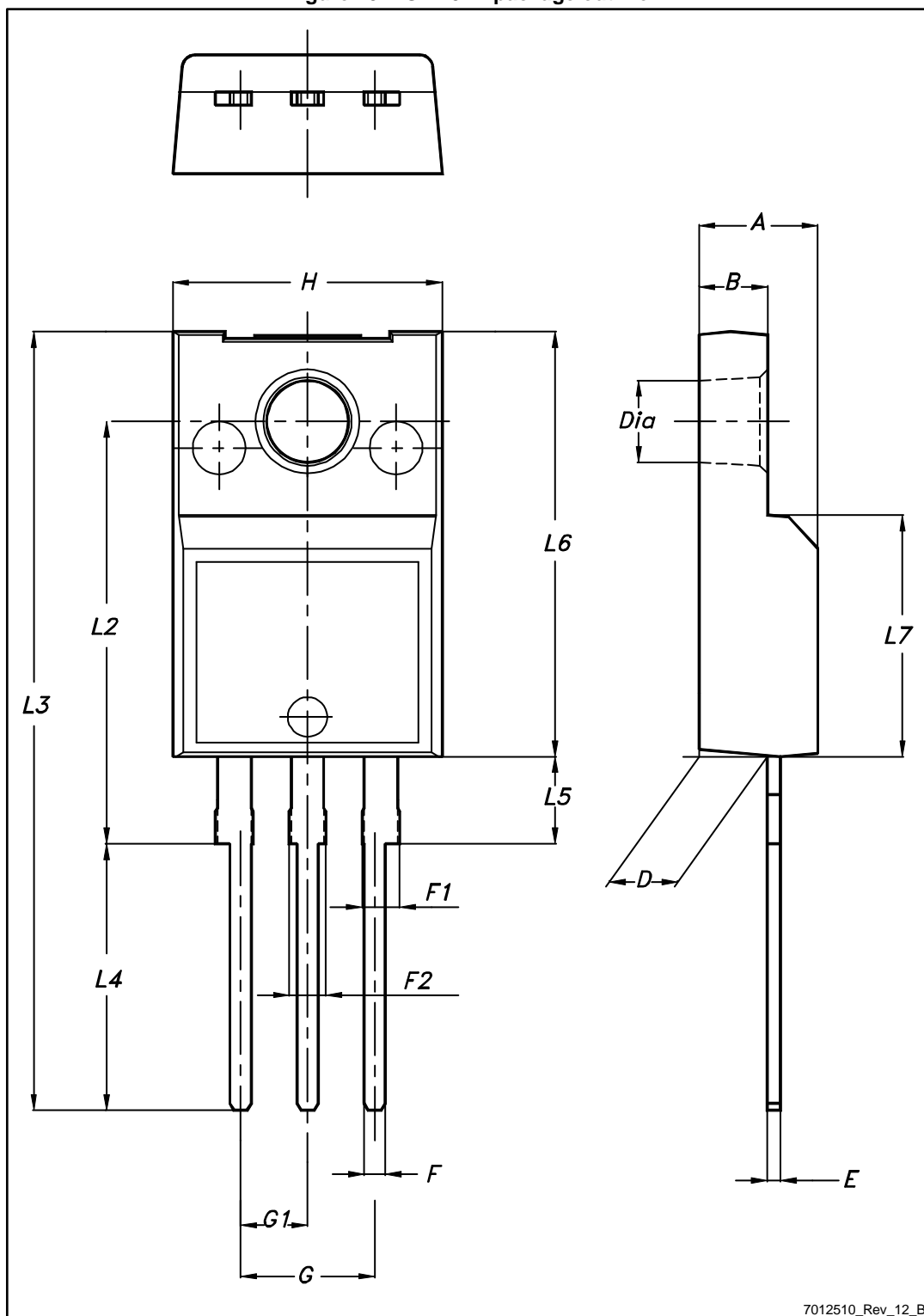

7012510\_Rev\_12\_B

Table 9: TO-220FP package mechanical data

Dim.	mm		
	Min.	Typ.	Max.
A	4.4		4.6
B	2.5		2.7
D	2.5		2.75
E	0.45		0.7
F	0.75		1
F1	1.15		1.70
F2	1.15		1.70
G	4.95		5.2
G1	2.4		2.7
H	10		10.4
L2		16	
L3	28.6		30.6
L4	9.8		10.6
L5	2.9		3.6
L6	15.9		16.4
L7	9		9.3
Dia	3		3.2

## 5 Revision history

Table 10: Document revision history

Date	Revision	Changes
20-Jun-2017	1	First release.

**IMPORTANT NOTICE – PLEASE READ CAREFULLY**

STMicroelectronics NV and its subsidiaries ("ST") reserve the right to make changes, corrections, enhancements, modifications, and improvements to ST products and/or to this document at any time without notice. Purchasers should obtain the latest relevant information on ST products before placing orders. ST products are sold pursuant to ST's terms and conditions of sale in place at the time of order acknowledgement.

Purchasers are solely responsible for the choice, selection, and use of ST products and ST assumes no liability for application assistance or the design of Purchasers' products.

No license, express or implied, to any intellectual property right is granted by ST herein.

Resale of ST products with provisions different from the information set forth herein shall void any warranty granted by ST for such product.

ST and the ST logo are trademarks of ST. All other product or service names are the property of their respective owners.

Information in this document supersedes and replaces information previously supplied in any prior versions of this document.

© 2017 STMicroelectronics – All rights reserved



Компания «ЭлектроПласт» предлагает заключение долгосрочных отношений при поставках импортных электронных компонентов на взаимовыгодных условиях!

Наши преимущества:

- Оперативные поставки широкого спектра электронных компонентов отечественного и импортного производства напрямую от производителей и с крупнейших мировых складов;
- Поставка более 17-ти миллионов наименований электронных компонентов;
- Поставка сложных, дефицитных, либо снятых с производства позиций;
- Оперативные сроки поставки под заказ (от 5 рабочих дней);
- Экспресс доставка в любую точку России;
- Техническая поддержка проекта, помощь в подборе аналогов, поставка прототипов;
- Система менеджмента качества сертифицирована по Международному стандарту ISO 9001;
- Лицензия ФСБ на осуществление работ с использованием сведений, составляющих государственную тайну;
- Поставка специализированных компонентов (Xilinx, Altera, Analog Devices, Intersil, Interpoint, Microsemi, Aeroflex, Peregrine, Syfer, Eurofarad, Texas Instrument, Miteq, Cobham, E2V, MA-COM, Hittite, Mini-Circuits, General Dynamics и др.);

Помимо этого, одним из направлений компании «ЭлектроПласт» является направление «Источники питания». Мы предлагаем Вам помощь Конструкторского отдела:

- Подбор оптимального решения, техническое обоснование при выборе компонента;
- Подбор аналогов;
- Консультации по применению компонента;
- Поставка образцов и прототипов;
- Техническая поддержка проекта;
- Защита от снятия компонента с производства.



#### Как с нами связаться

**Телефон:** 8 (812) 309 58 32 (многоканальный)

**Факс:** 8 (812) 320-02-42

**Электронная почта:** [org@eplast1.ru](mailto:org@eplast1.ru)

**Адрес:** 198099, г. Санкт-Петербург, ул. Калинина, дом 2, корпус 4, литера А.