

---

## 11V Input 150mA LDO

---

NO.EA-256-111020

### OUTLINE

The RP173x Series are CMOS-based voltage regulator ICs featuring 150 mA output and low supply current of Typ.2.0 $\mu$ A. Each of these ICs consists of a voltage reference unit, an error amplifier, a resistor-net for voltage setting, a current limit circuit, a chip enable circuit and a Reverse Current Protection Circuit. RP173x Series are suitable for the power source such as the equipment being in the standby-mode. A version with /CE input pin has reduced CE pull-up resistance to make its supply current ultra low.

The RP173x Series have Max.11V Input voltage and are applicable to the portable communication equipment that require the 2-cell Li-ion battery. Also they are applicable to the non-portable communication equipments. As this series includes Reverse Current Protection Circuit, there is little leakage current, if it's used as back-up circuit.

Since the packages for these ICs are the SOT-23-5 package, SC-88A, or DFN(PLP)1010-4 of 1mm square, high density mounting of the ICs on boards is possible.

### FEATURES

- Output Current ..... Typ. 150mA
- Supply Current ..... Typ. 2.0 $\mu$ A
- Standby Current ..... Typ. 0.2 $\mu$ A
- Input Voltage Range ..... 2.5V to Set  $V_{OUT}+6.5V$  (Max.11V)
- Output Voltage Range..... 1.2V to 5.5V (0.1V steps)  
(For other voltages, please refer to MARK INFORMATIONS.)
- Dropout Voltage ..... Typ. 0.13V (  $I_{OUT}=30mA$ ,  $V_{OUT}=3.0V$ )  
Typ. 0.90V (  $I_{OUT}=150mA$ ,  $V_{OUT}=3.0V$ )
- Output Voltage Accuracy.....  $\pm 1.0\%$ ( $1.5V < V_{OUT} \leq 5.5V$ ,  $T_{opt}=25^{\circ}C$ )
- Temperature-drift Coefficient of Output Voltage..... Typ.  $\pm 100ppm/^{\circ}C$
- Line Regulation ..... Typ. 0.02%/V
- Packages ..... DFN(PLP)1010-4, SC-88A, SOT-23-5
- Built-in Reverse Current Protection Circuit
- Short Current Limit ..... Typ. 45mA
- Built-in Peak Current Limit Circuit
- Output capacitors ..... 0.1 $\mu$ F or more

### APPLICATIONS

- Power source for portable communication equipments.
- Power source for battery-powered equipments.
- Power source for electrical appliances such as cameras, VSRs and camcorders.
- Power source for digital home appliances.

## BLOCK DIAGRAMS



## SELECTION GUIDE

The output voltage, auto discharge function, package for the ICs can be selected at the user's request.

Product Name	Package	Quantity per Reel	Pb Free	Halogen Free
RP173Kxx1*-TR	DFN(PLP)1010-4	10,000 pcs	Yes	Yes
RP173Qxx2*-TR-FE	SC-88A	3,000 pcs	Yes	Yes
RP173Nxx1*-TR-FE	SOT-23-5	3,000 pcs	Yes	Yes

xx: The output voltage can be designated in the range of 1.2V (12) to 5.5V (55) in 0.1V steps.  
(For other voltages, please refer to MARK INFORMATIONS.)

\* : The auto discharge function at off state are options as follows.  
 (A) "L" active, without auto discharge function at off state (Pull-up resistance is not built-in.)  
 (B) "H" active, without auto discharge function at off state  
 (D) "H" active, with auto discharge function at off state

## PIN CONFIGURATIONS

● DFN(PLP)1010-4

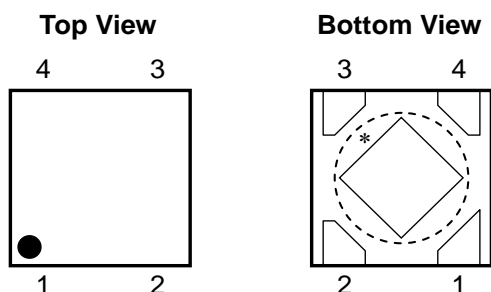

● SC-88A

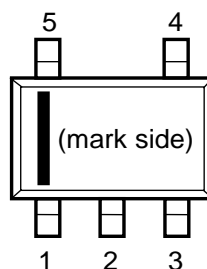

● SOT-23-5

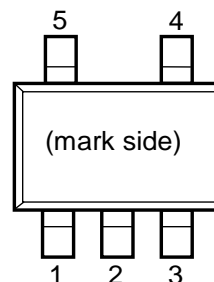

## PIN DESCRIPTIONS

●DFN(PLP)1010-4

Pin No.	Symbol	Description
1	$V_{OUT}$	Output Pin
2	GND	Ground Pin
3	$\overline{CE}$ /CE	Chip Enable Pin
4	$V_{DD}$	Input Pin

\*) Tab is GND level. (They are connected to the reverse side of this IC.)

The tab is better to be connected to the GND, but leaving it open is also acceptable.

●SC-88A

Pin No.	Symbol	Description
1	$\overline{CE}$ /CE	Chip Enable Pin
2	NC	No Connection
3	GND	Ground Pin
4	$V_{OUT}$	Output Pin
5	$V_{DD}$	Input Pin

●SOT-23-5

Pin No.	Symbol	Description
1	$V_{DD}$	Input Pin
2	GND	Ground Pin
3	$\overline{CE}$ /CE	Chip Enable Pin
4	NC	No Connection
5	$V_{OUT}$	Output Pin

## ABSOLUTE MAXIMUM RATINGS

Symbol	Item	Rating	Unit
$V_{IN}$	Input Voltage	12	V
$V_{CE}$	Input Voltage (CE pin)	12	V
$V_{OUT}$	Output Voltage	-0.3 to 6.0	V
$I_{OUT}$	Output Current	165	mA
$P_D$	Power Dissipation (DFN(PLP)1010-4)*	400	mW
	Power Dissipation (SC-88A)*	380	
	Power Dissipation (SOT-23-5)*	420	
$T_{opt}$	Operating Temperature Range	-40 to +85	°C
$T_{stg}$	Storage Temperature Range	-55 to +125	°C

\*) For Power Dissipation, please refer to PACKAGE INFORMATION.

### ABSOLUTE MAXIMUM RATINGS

Electronic and mechanical stress momentarily exceeded absolute maximum ratings may cause the permanent damages and may degrade the life time and safety for both device and system using the device in the field. The functional operation at or over these absolute maximum ratings is not assured.

## ELECTRICAL CHARACTERISTICS

Unless otherwise noted,  $V_{IN} = \text{Set } V_{OUT} + 1.0V (V_{OUT} > 1.5)$ ,  $I_{OUT} = 1\text{mA}$ ,  $C_{IN} = C_{OUT} = 0.1\mu\text{F}$ .  
 The values in   are applicable under the condition of  $-40^{\circ}\text{C} \leq T_{opt} \leq 85^{\circ}\text{C}$ .

● RP173xxxxA

$T_{opt} = 25^{\circ}\text{C}$

Symbol	Item	Conditions	Min.	Typ.	Max.	Unit	
$V_{OUT}$	Output Voltage	$T_{opt} = 25^{\circ}\text{C}$	$V_{OUT} > 1.5\text{V}$	$\times 0.99$		$\times 1.01$	V
			$V_{OUT} \leq 1.5\text{V}$	-15		15	mV
		$-40^{\circ}\text{C} \leq T_{opt} \leq 85^{\circ}\text{C}$	$V_{OUT} > 1.5\text{V}$	<span style="border: 1px solid black; padding: 0 2px;"><math>\times 0.982</math></span>		<span style="border: 1px solid black; padding: 0 2px;"><math>\times 1.018</math></span>	V
			$V_{OUT} \leq 1.5\text{V}$	<span style="border: 1px solid black; padding: 0 2px;">-28</span>		<span style="border: 1px solid black; padding: 0 2px;">27</span>	mV
$I_{OUT}$	Output Current		<span style="border: 1px solid black; padding: 0 2px;">150</span>			mA	
$\Delta V_{OUT} / \Delta I_{OUT}$	Load Regulation	$0.1\text{mA} \leq I_{OUT} \leq 150\text{mA}$	<span style="border: 1px solid black; padding: 0 2px;">-30</span>	-3	<span style="border: 1px solid black; padding: 0 2px;">35</span>	mV	
$V_{DIF}$	Dropout Voltage	Refer to the "Dropout Voltage"					
$I_{SS}$	Supply Current	$I_{OUT} = 0\text{mA}$		2.0	<span style="border: 1px solid black; padding: 0 2px;">3.7</span>	$\mu\text{A}$	
$I_{standby}$	Standby Current	$V_{IN} = V_{IN}(\text{Max.})$ $V_{CE} = 0\text{V}$		0.2	0.6	$\mu\text{A}$	
$\Delta V_{OUT} / \Delta V_{IN}$	Load Regulation	Set $V_{OUT} + 0.5\text{V} \leq V_{IN} \leq V_{IN}(\text{Max.})$ When $V_{OUT} \leq 2.0\text{V}$ , $2.5\text{V} \leq V_{IN} \leq V_{IN}(\text{Max.})$		0.02	<span style="border: 1px solid black; padding: 0 2px;">0.20</span>	%/V	
RR	Ripple Rejection	$f = 1\text{kHz}$ , Ripple $0.2\text{Vp-p}$ , $I_{OUT} = 10\text{mA}$ ※When $V_{OUT} < 2.0\text{V}$ , $V_{IN} = 3.0\text{V}$		30		dB	
$V_{IN}$	Input Voltage	$1.2 \leq V_{OUT} < 4.5$	<span style="border: 1px solid black; padding: 0 2px;">2.5</span>		$V_{set} + 6.5$	V	
		$4.5 \leq V_{OUT} \leq 5.5$	<span style="border: 1px solid black; padding: 0 2px;">2.5</span>		<span style="border: 1px solid black; padding: 0 2px;">11</span>	V	
$\Delta V_{OUT} / \Delta T_{opt}$	Output Voltage Temperature Coefficient	$-40^{\circ}\text{C} \leq T_{opt} \leq 85^{\circ}\text{C}$		$\pm 100$		ppm/ $^{\circ}\text{C}$	
$I_{SC}$	Short Current Limit Circuit	$V_{OUT} = 0\text{V}$		45		mA	
$V_{CEH}$	$\overline{\text{CE}}$ Input Voltage "H"		<span style="border: 1px solid black; padding: 0 2px;">1.7</span>			V	
$V_{CEL}$	$\overline{\text{CE}}$ Input Voltage "L"				<span style="border: 1px solid black; padding: 0 2px;">0.8</span>	V	
$I_{REV}$	Reverse Current	$0 \leq V_{IN} \leq 11.0\text{V}$ , $V_{OUT} \geq 1.5\text{V}$		0	0.16	$\mu\text{A}$	
$V_{REV\_DET}^*$	Reverse Current Protection Mode Detection Offset, $V_{REV} = V_{DD} - V_{OUT}$	$0 \leq V_{IN} \leq 11.0\text{V}$ , $V_{OUT} \geq 1.5\text{V}$		55	<span style="border: 1px solid black; padding: 0 2px;">100</span>	mV	
$V_{REV\_REL}^*$	Reverse Current Protection Mode Release Offset	$0 \leq V_{IN} \leq 11.0\text{V}$ , $V_{OUT} \geq 1.5\text{V}$		70	<span style="border: 1px solid black; padding: 0 2px;">120</span>	mV	

The values in   have been tested and guaranteed by Design Engineering.

All of units are tested and specified under the pulse load conditions such that  $T_j \approx T_{opt} \pm 25^{\circ}\text{C}$  except for Ripple Rejection and Output Voltage Temperature Coefficient.

\*) The operation coverage of the Reverse Current Protection Circuit is  $V_{OUT} \geq 1.5\text{V}$ . However, under the condition of  $V_{IN} = V_{OUT} = 0\text{V}$ , always the Reverse Current Protection Circuit is operating.

## RP173x

Unless otherwise noted,  $V_{IN} = \text{Set } V_{OUT} + 1.0V (V_{OUT} > 1.5)$ ,  $I_{OUT} = 1\text{mA}$ ,  $C_{IN} = C_{OUT} = 0.1\mu\text{F}$ .

The values in   are applicable under the condition of  $-40^{\circ}\text{C} \leq T_{opt} \leq 85^{\circ}\text{C}$ .

### • RP173xxxxB/D

$T_{opt} = 25^{\circ}\text{C}$

Symbol	Item	Conditions	Min.	Typ.	Max.	Unit	
$V_{OUT}$	Output Voltage	$T_{opt} = 25^{\circ}\text{C}$	$V_{OUT} > 1.5\text{V}$	$\times 0.99$		$\times 1.01$	V
			$V_{OUT} \leq 1.5\text{V}$	-15		15	mV
		$-40^{\circ}\text{C} \leq T_{opt} \leq 85^{\circ}\text{C}$	$V_{OUT} > 1.5\text{V}$	<span style="border: 1px solid black; padding: 0 2px;">×0.982</span>		<span style="border: 1px solid black; padding: 0 2px;">×1.018</span>	V
			$V_{OUT} \leq 1.5\text{V}$	<span style="border: 1px solid black; padding: 0 2px;">-28</span>		<span style="border: 1px solid black; padding: 0 2px;">27</span>	mV
$I_{OUT}$	Output Current		<span style="border: 1px solid black; padding: 0 2px;">150</span>			mA	
$\Delta V_{OUT}/\Delta I_{OUT}$	Load Regulation	$0.1\text{mA} \leq I_{OUT} \leq 150\text{mA}$	<span style="border: 1px solid black; padding: 0 2px;">-30</span>	-3	<span style="border: 1px solid black; padding: 0 2px;">35</span>	mV	
$V_{DIF}$	Dropout Voltage	Refer to the "Dropout Voltage"					
$I_{SS}$	Supply Current	$I_{OUT} = 0\text{mA}$		2.0	<span style="border: 1px solid black; padding: 0 2px;">3.7</span>	$\mu\text{A}$	
$I_{standby}$	Standby Current	$V_{IN} = V_{IN\_Max}$ $V_{CE} = 0\text{V}$		0.2	0.6	$\mu\text{A}$	
$\Delta V_{OUT}/\Delta V_{IN}$	Load Regulation	Set $V_{OUT} + 0.5\text{V} \leq V_{IN} \leq V_{IN\_Max}$ . When $V_{OUT} \leq 2.0\text{V}$ , $2.5\text{V} \leq V_{IN} \leq \text{Set } V_{OUT} + 6.5\text{V}$		0.02	<span style="border: 1px solid black; padding: 0 2px;">0.20</span>	%/V	
RR	Ripple Rejection	$f = 1\text{kHz}$ , Ripple $0.2\text{Vp-p}$ , $I_{OUT} = 10\text{mA}$ ※When $V_{OUT} < 2.0\text{V}$ , $V_{IN} = 3.0\text{V}$		30		dB	
$V_{IN}$	Input Voltage	$1.2 \leq V_{OUT} < 4.5$	<span style="border: 1px solid black; padding: 0 2px;">2.5</span>		$V_{set} + 6.5$	V	
		$4.5 \leq V_{OUT} \leq 5.5$	<span style="border: 1px solid black; padding: 0 2px;">2.5</span>		<span style="border: 1px solid black; padding: 0 2px;">11</span>	V	
$\Delta V_{OUT}/\Delta T_{opt}$	Output Voltage Temperature Coefficient	$-40^{\circ}\text{C} \leq T_{opt} \leq 85^{\circ}\text{C}$		$\pm 100$		ppm/ $^{\circ}\text{C}$	
$I_{SC}$	Short Current Limit Circuit	$V_{OUT} = 0\text{V}$		45		mA	
$I_{PD}$	CE Pull-down Current			0.30	<span style="border: 1px solid black; padding: 0 2px;">0.90</span>	$\mu\text{A}$	
$V_{CEH}$	CE Input Voltage "H"		<span style="border: 1px solid black; padding: 0 2px;">1.7</span>			V	
$V_{CEL}$	CE Input Voltage "L"				<span style="border: 1px solid black; padding: 0 2px;">0.8</span>	V	
$I_{REV}$	Reverse Current	$0 \leq V_{IN} \leq 11.0\text{V}$ , $V_{OUT} \geq 1.5\text{V}$		0	0.16	$\mu\text{A}$	
$V_{REV\_DET}^*$	Reverse Current Protection Mode Detection Offset $V_{REV} = V_{DD} - V_{OUT}$	$0 \leq V_{IN} \leq 11.0\text{V}$ , $V_{OUT} \geq 1.5\text{V}$		55	<span style="border: 1px solid black; padding: 0 2px;">100</span>	mV	
$V_{REV\_REL}^*$	Reverse Current Protection Mode Release Offset	$0 \leq V_{IN} \leq 11.0\text{V}$ , $V_{OUT} \geq 1.5\text{V}$		70	<span style="border: 1px solid black; padding: 0 2px;">120</span>	mV	
$R_{LOW}$	Autodischarge Nch Tr. ON Resistance (D Version only)	$V_{IN} = 7.0\text{V}$ , $V_{CE} = 0\text{V}$		380		$\Omega$	

The values in   have been tested and guaranteed by Design Engineering.

All of units are tested and specified under the pulse load conditions such that  $T_j \approx T_{opt} = 25^{\circ}\text{C}$  except for Ripple Rejection and Output Voltage Temperature Coefficient.

\*) The operation coverage of the Reverse Current Protection Circuit is  $V_{OUT} \geq 1.5\text{V}$ . However, under the condition of  $V_{IN} = V_{OUT} = 0\text{V}$ , always the Reverse Current Protection Circuit is operating.

• Dropout Voltage

$T_{opt}=25^{\circ}\text{C}$

Output Voltage $V_{OUT}$ (V)	Dropout Voltage $V_{DIF}$ (V)		
	Condition	Typ.	Max.
$1.2 \leq V_{OUT} < 1.3$	$I_{OUT}=150\text{mA}$	1.68	2.59
$1.3 \leq V_{OUT} < 1.5$		1.63	2.49
$1.5 \leq V_{OUT} < 1.8$		1.48	2.23
$1.8 \leq V_{OUT} < 2.3$		1.16	2.19
$2.3 \leq V_{OUT} < 3.0$		0.90	1.47
$3.0 \leq V_{OUT} < 4.0$		0.61	1.05
$4.0 \leq V_{OUT} \leq 5.5$		0.39	0.76

The values in  are applicable under the condition of  $-40^{\circ}\text{C} \leq T_{opt} \leq 85^{\circ}\text{C}$ .

**RECOMMENDED OPERATING CONDITIONS (ELECTRICAL CHARACTERISTICS)**

All of electronic equipment should be designed that the mounted semiconductor devices operate within the recommended operating conditions. The semiconductor devices cannot operate normally over the recommended operating conditions, even if when they are used over such conditions by momentary electronic noise or surge. And the semiconductor devices may receive serious damage when they continue to operate over the recommended operating conditions.

## TYPICAL APPLICATIONS



External Parts Example:

C2: Ceramic Capacitor 0.1 $\mu$ F, Murata, GRM155B31C104KA87D

## TECHNICAL NOTES

When using the ICs, please note the following points.

### Phase Compensation

In these ICs, phase compensation is made for securing stable operation even if the load current is varied. For this purpose, use a 0.1 $\mu$ F or more capacitor C2.

In case of using a tantalum capacitor, the output may be unstable due to inappropriate ESR. Therefore, the full range of operating conditions for the capacitor in the application should be considered.

### PCB Layout

Make  $V_{DD}$  and GND lines sufficient. If their impedance is high, noise pickup or unstable operation may result. Connect a capacitor C1 with a capacitance value as much as 0.1 $\mu$ F or more between  $V_{DD}$  and GND pin, and as close as possible to the pins.

Set external components, especially the output capacitor C2, as close as possible to the ICs, and make wiring as short as possible.

## POWER ACTIVATION

If the ICs are started up with  $V_{IN}$  and  $V_{CE}$  under the no-load condition, the both pin voltages have to be started up with faster than 2.0V/s. If the IC is started up with slower than 2.0V/s under the no-load condition, start up the IC only with  $V_{CE}$ .



## REVERSE CURRENT PROTECTION CIRCUIT

The RP173 Series include a Reverse Current Protection Circuit, which stops the reverse current from  $V_{OUT}$  pin to  $V_{DD}$  pin or to GND pin when  $V_{OUT}$  becomes higher than  $V_{IN}$ .

Usually, the LDO using Pch output transistor contains a parasitic diode between  $V_{DD}$  pin and  $V_{OUT}$  pin. Therefore, if  $V_{OUT}$  is higher than  $V_{IN}$ , the parasitic diode becomes forward direction. As a result, the current flows from  $V_{OUT}$  pin to  $V_{DD}$  pin.

The ICs of this series switches the mode to the reverse current protection mode before  $V_{IN}$  becomes lower than  $V_{OUT}$  by connecting the parasitic diode of Pch output transistor to the backward direction, and connecting the gate to  $V_{OUT}$  pin. As a result, the Pch output transistor is turned off and the all the current pathways from  $V_{OUT}$  pin to GND pin are shut down to maintain the reverse current lower than  $[I_{REV}]$  of the Electrical Characteristics.

Switching to either the normal mode or to the reverse current protection mode is determined by the magnitude of  $V_{IN}$  voltage and  $V_{OUT}$  voltage. For the stable operation, offset and hysteresis are set as the threshold. The detection/ release thresholds of both normal and reverse current protection modes are specified by  $[V_{REV\_DET}]$  and  $[V_{REV\_REL}]$  of the Electrical Characteristics. Therefore, the minimum dropout voltage under the small load current condition is restricted by the value of  $[V_{REV\_REL}]$ .

Fig.1 and Fig.2 show the diagrams of each mode, and Fig.3 shows the load characteristics of each mode. When giving the  $V_{OUT}$  pin a constant-voltage and decreasing the  $V_{IN}$  voltage, the dropout voltage will become lower than the  $[V_{REV\_DET}]$ . As a result, the reverse current protection starts to function to stop the load current. By increasing the dropout voltage higher than the  $[V_{REV\_REL}]$ , the protection mode will be released to let the load current to flow. If the dropout voltage to be used is lower than  $[V_{REV\_REL}]$ , the detection and the release may be repeated.

The operation coverage of the Reverse Current Protection Circuit is  $V_{OUT} \geq 1.5V$ . However, under the condition of  $V_{IN}=0V$ , always the reverse current protection mode is operating.

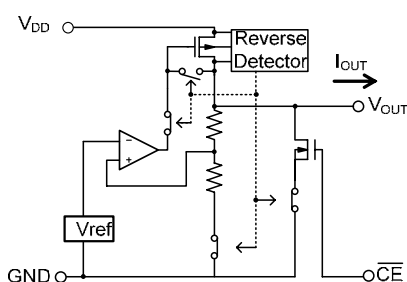

Fig. 1 Normal Mode

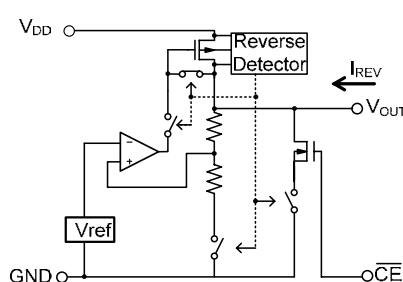

Fig. 2 Reverse Current Protection Mode

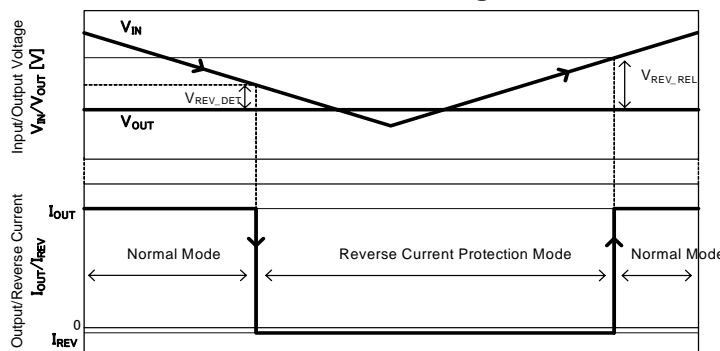

Fig. 3 Reverse Current Protection Mode Detection/ Release & Reverse Current/ Output Current Characteristics

TEST CIRCUITS



Basic Test Circuit



Supply Current Test Circuit



Ripple Rejection Test Circuit



Load Transient Response Test Circuit

## TYPICAL CHARACTERISTICS

1) Output Voltage vs. Output Current ( $C_1$ =Ceramic 0.1 $\mu$ F,  $C_2$ =Ceramic 0.1 $\mu$ F,  $T_{opt}$ =25°C)



2) Output Voltage vs. Input Voltage ( $C_1$ =Ceramic 0.1 $\mu$ F,  $C_2$ =Ceramic 0.1 $\mu$ F,  $T_{opt}$ =25°C)



RP173x30xx



RP173x55xx



3) Supply Current vs. Input Voltage (C1=Ceramic 0.1 $\mu$ F, C2=Ceramic 0.1 $\mu$ F, T<sub>opt</sub>=25°C)

RP173x12xx



RP173x18xx



RP173x30xx



RP173x55xx



4) Output Voltage vs. Temperature (C1=Ceramic 0.1 $\mu$ F, C2=Ceramic 0.1 $\mu$ F, I<sub>OUT</sub>=1mA)



5) Dropout Voltage vs. Output Current (C1=Ceramic 0.1 $\mu$ F, C2=Ceramic 0.1 $\mu$ F)



RP173x55xx



6) Dropout Voltage vs. Set Output Voltage (C1=Ceramic 0.1 $\mu$ F, C2=Ceramic 0.1 $\mu$ F, T<sub>opt</sub>=25°C)

RP173x



7) Minimum Operating Voltage (C1=Ceramic 0.1 $\mu$ F, C2=Ceramic 0.1 $\mu$ F, T<sub>opt</sub>=-40~85°C)



8) Ripple Rejection vs. Input Vias Voltage (C1=none, C2=Ceramic 0.1μF, Ripple=0.2Vp-p, T<sub>opt</sub>=25°C)



9) Ripple Rejection vs. Temperature (C1=none, C2=Ceramic 0.1μF, Ripple=0.2Vp-p, T<sub>opt</sub>=25°C)





**10) Input Transient Response ( $C1=none$ ,  $C2=Ceramic\ 0.1\mu F$ ,  $t_r=t_f=5.0\mu s$ ,  $T_{opt}=25^\circ C$ )**





RP173x12xx



RP173x18xx



RP173x30xx



RP173x55xx



11) Load Transient Response ( $C1$ =Ceramic  $0.1\mu\text{F}$ ,  $C2$ =Ceramic  $0.1\mu\text{F}$ ,  $t_r=t_f=0.5\mu\text{s}$ ,  $T_{opt}=25^\circ\text{C}$ )

RP173x12xx



RP173x18xx

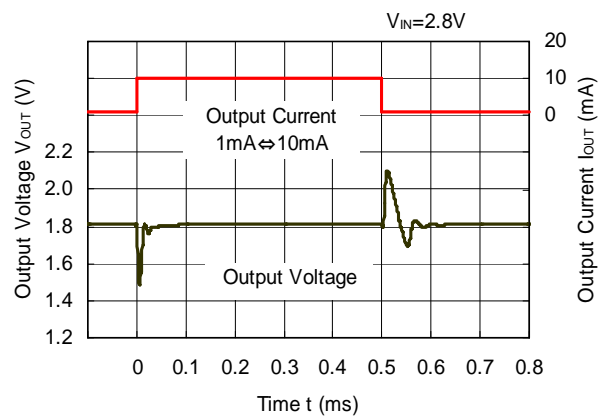

RP173x30xx



RP173x55xx



RP173x12xx



RP173x18xx



RP173x30xx



RP173x55xx



12) Turn on Speed (C1=Ceramic 0.1μF, C2=Ceramic 0.1μF, Topt=25°C)



13) Turn off Speed with CE pin (C1=Ceramic 0.1μF, C2=Ceramic 0.1μF, Topt=25°C)



RP173x30xx



RP173x55xx



### ESR vs. Output Current

When using these ICs, consider the following points: The relations between  $I_{OUT}$  (Output Current) and ESR of an output capacitor are shown below. The conditions when the white noise level is under  $40\mu V$  (Avg.) are marked as the hatched area in the graph.

#### Measurement Conditions

- Frequency Band : 10Hz to 2MHz
- Temperature :  $-40^{\circ}C$  to  $85^{\circ}C$
- C1,C2 :  $0.1\mu F$

RP173x0121x

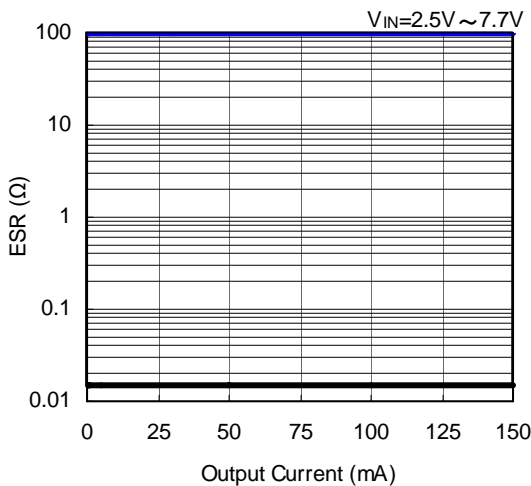

RP173x301x



RP173x551x





1. The products and the product specifications described in this document are subject to change or discontinuation of production without notice for reasons such as improvement. Therefore, before deciding to use the products, please refer to Ricoh sales representatives for the latest information thereon.
2. The materials in this document may not be copied or otherwise reproduced in whole or in part without prior written consent of Ricoh.
3. Please be sure to take any necessary formalities under relevant laws or regulations before exporting or otherwise taking out of your country the products or the technical information described herein.
4. The technical information described in this document shows typical characteristics of and example application circuits for the products. The release of such information is not to be construed as a warranty of or a grant of license under Ricoh's or any third party's intellectual property rights or any other rights.
5. The products listed in this document are intended and designed for use as general electronic components in standard applications (office equipment, telecommunication equipment, measuring instruments, consumer electronic products, amusement equipment etc.). Those customers intending to use a product in an application requiring extreme quality and reliability, for example, in a highly specific application where the failure or misoperation of the product could result in human injury or death (aircraft, spacevehicle, nuclear reactor control system, traffic control system, automotive and transportation equipment, combustion equipment, safety devices, life support system etc.) should first contact us.
6. We are making our continuous effort to improve the quality and reliability of our products, but semiconductor products are likely to fail with certain probability. In order to prevent any injury to persons or damages to property resulting from such failure, customers should be careful enough to incorporate safety measures in their design, such as redundancy feature, fire containment feature and fail-safe feature. We do not assume any liability or responsibility for any loss or damage arising from misuse or inappropriate use of the products.
7. Anti-radiation design is not implemented in the products described in this document.
8. Please contact Ricoh sales representatives should you have any questions or comments concerning the products or the technical information.



**Ricoh is committed to reducing the environmental loading materials in electrical devices with a view to contributing to the protection of human health and the environment.**

Ricoh has been providing RoHS compliant products since April 1, 2006 and Halogen-free products since April 1, 2012.

**RICOH** RICOH ELECTRONIC DEVICES CO., LTD.

<http://www.e-devices.ricoh.co.jp/en/>

#### Sales & Support Offices

##### **RICOH ELECTRONIC DEVICES CO., LTD.**

**Higashi-Shinagawa Office (International Sales)**  
3-32-3, Higashi-Shinagawa, Shinagawa-ku, Tokyo 140-8655, Japan  
Phone: +81-3-5479-2857 Fax: +81-3-5479-0502

##### **RICOH EUROPE (NETHERLANDS) B.V.**

**Semiconductor Support Centre**  
Prof. W.H. Keesomlaan 1, 1183 DJ Amstelveen, The Netherlands  
Phone: +31-20-5474-309

##### **RICOH ELECTRONIC DEVICES KOREA CO., LTD.**

3F, Haesung Bldg. 504, Teheran-ro, Gangnam-gu, Seoul, 135-725, Korea  
Phone: +82-2-2135-5700 Fax: +82-2-2051-5713

##### **RICOH ELECTRONIC DEVICES SHANGHAI CO., LTD.**

Room 403, No.2 Building, No.690 Bilbo Road, Pu Dong New District, Shanghai 201203,  
People's Republic of China  
Phone: +86-21-5027-3200 Fax: +86-21-5027-3299

##### **RICOH ELECTRONIC DEVICES CO., LTD.**

**Taipei office**  
Room 109, 10F-1, No.51, Hengyang Rd., Taipei City, Taiwan (R.O.C.)  
Phone: +886-2-2313-1621/1622 Fax: +886-2-2313-1623

# Mouser Electronics

Authorized Distributor

Click to View Pricing, Inventory, Delivery & Lifecycle Information:

## Ricoh Electronics:

[RP173N181D-TR-FE](#) [RP173K121D-TR](#) [RP173N301B-TR-FE](#) [RP173N121D-TR-FE](#) [RP173N331D-TR-FE](#)  
[RP173N331B-TR-FE](#) [RP173N251B-TR-FE](#) [RP173K331D-TR](#) [RP173N251D-TR-FE](#) [RP173N501D-TR-FE](#)  
[RP173K301D-TR](#) [RP173K281D-TR](#) [RP173K501D-TR](#) [RP173N301D-TR-FE](#) [RP173N501B-TR-FE](#) [RP173K301B-TR](#)



Компания «ЭлектроПласт» предлагает заключение долгосрочных отношений при поставках импортных электронных компонентов на взаимовыгодных условиях!

Наши преимущества:

- Оперативные поставки широкого спектра электронных компонентов отечественного и импортного производства напрямую от производителей и с крупнейших мировых складов;
- Поставка более 17-ти миллионов наименований электронных компонентов;
- Поставка сложных, дефицитных, либо снятых с производства позиций;
- Оперативные сроки поставки под заказ (от 5 рабочих дней);
- Экспресс доставка в любую точку России;
- Техническая поддержка проекта, помощь в подборе аналогов, поставка прототипов;
- Система менеджмента качества сертифицирована по Международному стандарту ISO 9001;
- Лицензия ФСБ на осуществление работ с использованием сведений, составляющих государственную тайну;
- Поставка специализированных компонентов (Xilinx, Altera, Analog Devices, Intersil, Interpoint, Microsemi, Aeroflex, Peregrine, Syfer, Eurofarad, Texas Instrument, Miteq, Cobham, E2V, MA-COM, Hittite, Mini-Circuits, General Dynamics и др.);

Помимо этого, одним из направлений компании «ЭлектроПласт» является направление «Источники питания». Мы предлагаем Вам помощь Конструкторского отдела:

- Подбор оптимального решения, техническое обоснование при выборе компонента;
- Подбор аналогов;
- Консультации по применению компонента;
- Поставка образцов и прототипов;
- Техническая поддержка проекта;
- Защита от снятия компонента с производства.



#### Как с нами связаться

**Телефон:** 8 (812) 309 58 32 (многоканальный)

**Факс:** 8 (812) 320-02-42

**Электронная почта:** [org@eplast1.ru](mailto:org@eplast1.ru)

**Адрес:** 198099, г. Санкт-Петербург, ул. Калинина, дом 2, корпус 4, литера А.