



3.3V

Low-Power CMOS Oscillator

## General Description

The DSC1033 is a 3.3V fixed frequency MEMS based PureSilicon™ Oscillator. It can be factory programmed to any frequency from 1 to 150MHz.

The DSC1033 incorporates an all silicon resonator that is extremely robust and nearly immune to stress related fractures, common to crystal based oscillators. Without sacrificing the performance and stability required of today's systems, a crystal-less design allows for a higher level of reliability, making the DSC1033 ideal for rugged, industrial, and portable applications where stress, shock, and vibration can damage quartz crystal based systems.

Available in industry standard packages, the DSC1033 can be "dropped-in" to the same PCB footprint as standard crystal oscillators.

## Block Diagram

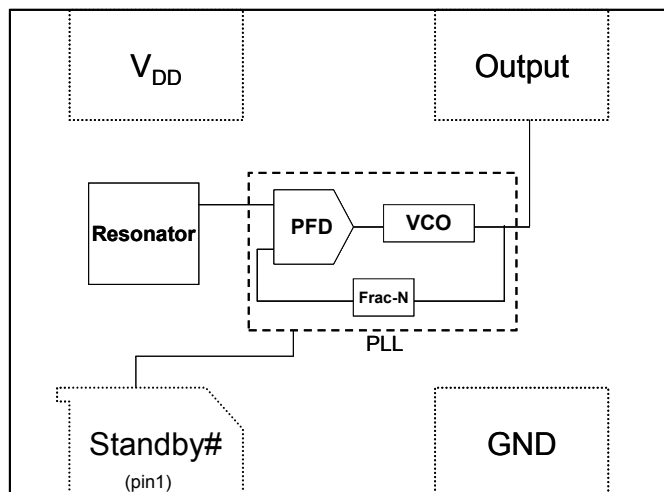

## Features

- Frequency Range: 1 to 150MHz
- Exceptional Stability over Temperature
  - $\pm 25$  PPM,  $\pm 50$  PPM
- Operating voltage
  - 3.0 to 3.6V
- Operating Temperature Range
  - Industrial  $-40^{\circ}\text{C}$  to  $85^{\circ}\text{C}$
  - Ext. Commercial  $-20^{\circ}\text{C}$  to  $70^{\circ}\text{C}$
  - Commercial  $0^{\circ}\text{C}$  to  $70^{\circ}\text{C}$
- Low Operating and Standby Current
  - 3mA Operating (40MHz)
  - 1uA Standby
- Ultra Miniature Footprint
  - $2.5 \times 2.0 \times 0.85$  mm
  - $3.2 \times 2.5 \times 0.85$  mm
  - $5.0 \times 3.2 \times 0.85$  mm
  - $7.0 \times 5.0 \times 0.85$  mm
- Excellent Shock and Vibration Resistance
- Lead Free, RoHS & Reach SVHC Compliant

## Benefits

- Pin for pin "drop in" replacement for industry standard oscillators
- Semiconductor level reliability, significantly higher than quartz
- Short mass production lead-times
- Longer Battery Life / Reduced Power
- Compact Plastic package
- Cost Effective

## Applications

- Mobile Applications
- Consumer Electronics
- Portable Electronics
- CCD Clock for VTR Cameras
- Low Profile Applications
- Industrial

## Absolute Maximum Ratings<sup>1</sup>

Item	Min.	Max	Unit	Condition
Supply Voltage	-0.3	+4.0	V	
Input Voltage	-0.3	V <sub>DD</sub> +0.3	V	
Junction Temp	-	+150	°C	
Storage Temp	-55	+150	°C	
Soldering Temp	-	+260	°C	40 sec max.
ESD	-		V	
HBM		2000		
MM		200		
CDM		500		

## Ordering Code



\* See Ordering Information for details

## Recommended Operating Conditions

Parameter	Symbol	Range
Supply Voltage	V <sub>DD</sub>	3.0 – 3.6V
Output Load	Z <sub>L</sub>	R>10KΩ, C≤15pF
Operating Temperature	T	
Option 1		-40 – +85 °C
Option 2		-20 – +70 °C
Option 3		0 – +70 °C

## Specifications

Parameter	Symbol	Condition	Min.	Typ.	Max.	Unit
Frequency	f <sub>0</sub>	Single Frequency	1		150	MHz
Frequency Tolerance						
Option 1		-40°C to +85°C			±25,±50	ppm
Option 2		-20°C to +70°C			±25,±50	
Option 3		0°C to +70°C			±25,±50	
Supply Current, no load	I <sub>DD</sub>	C <sub>L</sub> =0p R <sub>L</sub> =∞ T=25° C	1 to 40MHz 40 to 80MHz 80 to 125MHz 125 to 150MHz	3 4 5 6	10	mA
Supply Current, standby	I <sub>DD</sub>	T=25°C			1.0	uA
Output Logic Levels						
Output logic high	V <sub>OH</sub>	C <sub>L</sub> =15pF	0.8*V <sub>DD</sub>		-	Volts
Output logic low	V <sub>OL</sub>		-		0.2*V <sub>DD</sub>	
Output Transition time						
Rise Time	t <sub>R</sub>	C <sub>L</sub> =15pF; T=25°C		1.3	2	ns
Fall Time	t <sub>F</sub>	20%/80%*V <sub>DD</sub>		1.3	2	
Output Startup Time <sup>2</sup>	t <sub>SU</sub>	T=25°C		1.5	3	ms
Output Disable Time	t <sub>DA</sub>			20	100	ns
Output Duty Cycle	SYM		45		55	%
Input Logic Levels						
Input logic high	V <sub>IH</sub>		0.75*V <sub>DD</sub>		-	Volts
Input logic low	V <sub>IL</sub>		-		0.25* V <sub>DD</sub>	
Jitter, Cycle to Cycle	J <sub>CC</sub>	F = 100MHz <sup>3</sup>		95		ps

### Notes:

- Absolute maximum ratings are those values beyond which the safety of the device cannot be guaranteed. The device should not be operated beyond these limits.
- t<sub>SU</sub> is time to stable output frequency after V<sub>DD</sub> is applied. t<sub>SU</sub> and t<sub>EN</sub> (after EN is asserted) are identical values.
- See typical cycle to cycle jitter graph for frequency dependence.

## Nominal Performance Characteristics

### 3.3V Characteristics

**Supply Current**



**Standby Current**

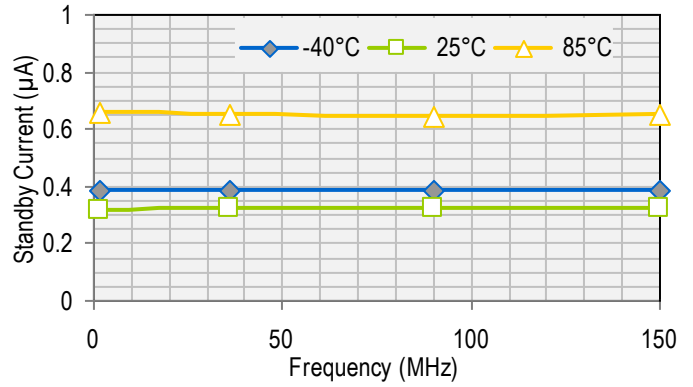

**Rise Time**

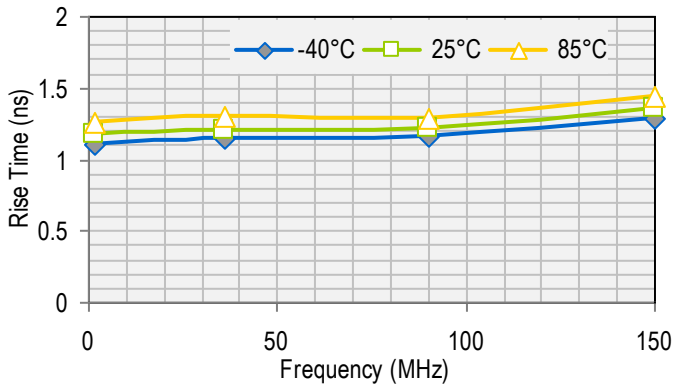

**Fall Time**

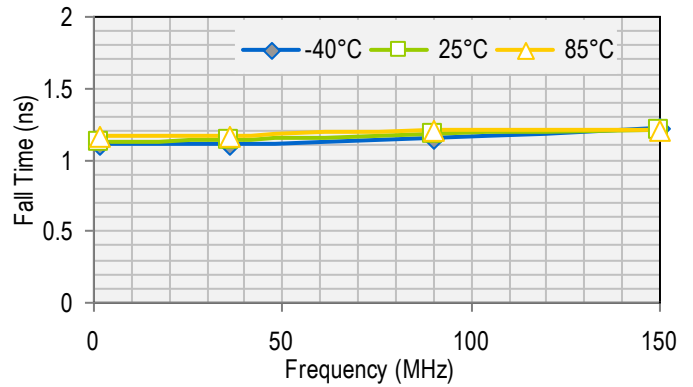

**Period Jitter**



**Cycle to Cycle Jitter**

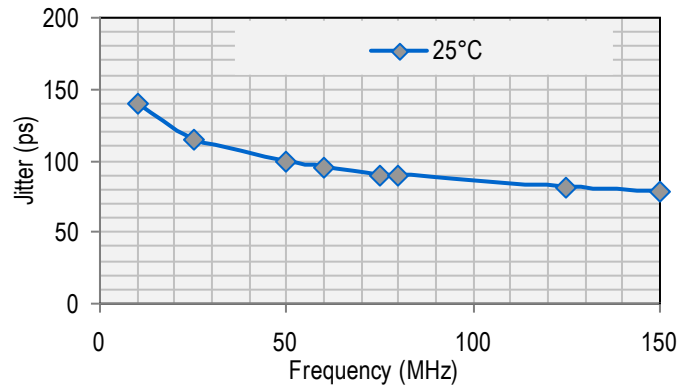

## Output Waveform



## Standby Function

Standby# (pin 1)	Output (pin 3)
Hi Level	Output ON
Open (no connect)	Output ON
Low Level	High Impedance

## Test Circuit



## Board Layout (recommended)



## Solder Reflow Profile

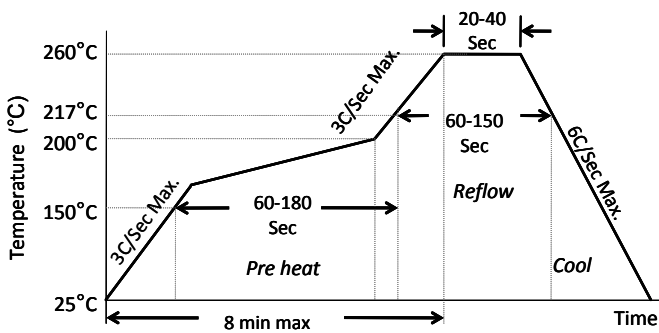

MSL 1 @ 260°C refer to JSTD-020C	
Ramp-Up Rate (200°C to Peak Temp)	3°C/Sec Max.
Preheat Time 150°C to 200°C	60-180 Sec
Time maintained above 217°C	60-150 Sec
Peak Temperature	255-260°C
Time within 5°C of actual Peak	20-40 Sec
Ramp-Down Rate	6°C/Sec Max.
Time 25°C to Peak Temperature	8 min Max.

## Package Dimensions

### 7.0 x 5.0 mm Plastic Package

#### External Dimensions

#### Recommended Land Pattern\*

No.	Pin Terminal
1	Standby#
2	GND
3	Output
4	VDD

units: mm [inch]

### 5.0 x 3.2 mm Plastic Package



### 3.2 x 2.5 mm Plastic Package



## 2.5 x 2.0 mm Plastic Package

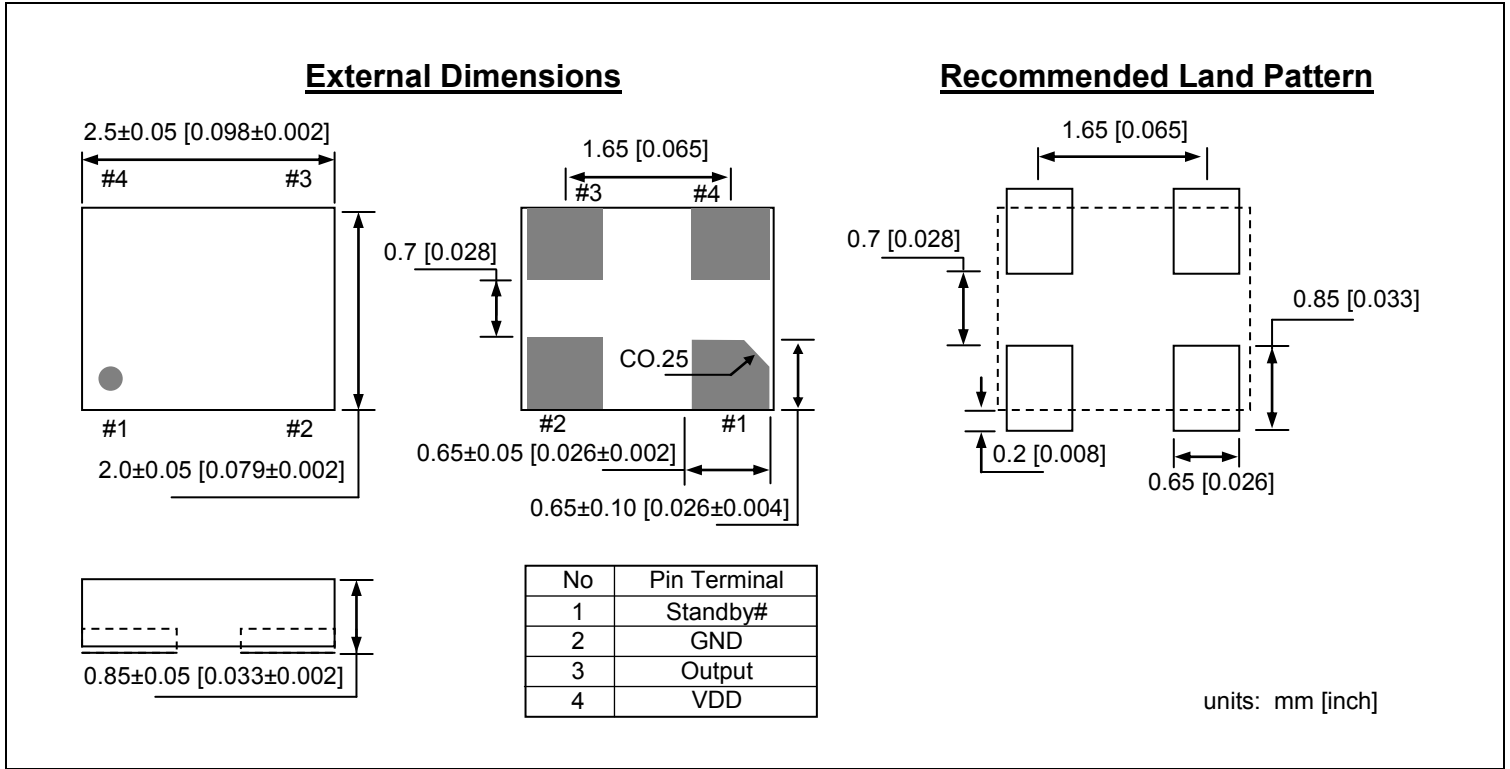

## Ordering Information

### DSC1033 PTS – xxx.xxxx T

PART NUMBERING GUIDE				
Package (Plastic QFN)	Temperature	Stability	Frequency	Packing Option
<b>P=A:</b> 7.0x5.0mm <b>P=B:</b> 5.0x3.2mm <b>P=C:</b> 3.2x2.5mm <b>P=D:</b> 2.5x2.0mm	<b>T=C:</b> 0° ~ +70° C <b>T=E:</b> -20° ~ +70° C <b>T=I:</b> -40° ~ +85° C	<b>S=1:</b> ±50ppm <b>S=2:</b> ±25ppm	<b>XXX.XXXX</b> (4 decimal places)	<b>Blank:</b> Tubes <b>T:</b> Tape & Reel

Example: DSC1033CE1-123.0000T

The example part number above is a 123.0000MHz oscillator in Plastic 3.2x2.5mm package, with ±50ppm stability over an operating temperature of -20 to +70°C, shipped in Tape and Reel. The reel size (7" or 13" diameter) will be determined by the factory based on quantity.

### Disclaimer:

Micrel makes no representations or warranties with respect to the accuracy or completeness of the information furnished in this data sheet. This information is not intended as a warranty and Micrel does not assume responsibility for its use. Micrel reserves the right to change circuitry, specifications and descriptions at any time without notice. No license, whether express, implied, arising by estoppel or otherwise, to any intellectual property rights is granted by this document. Except as provided in Micrel's terms and conditions of sale for such products, Micrel assumes no liability whatsoever, and Micrel disclaims any express or implied warranty relating to the sale and/or use of Micrel products including liability or warranties relating to fitness for a particular purpose, merchantability, or infringement of any patent, copyright or other intellectual property right.

**MICREL, Inc.**  
 Phone: +1 (408) 944-0800

• **2180 Fortune Drive,** **San Jose, California 95131** •  
 • **Fax: +1 (408) 474-1000** • **Email: hbwhelp@micrel.com** •

**USA**  
[www.micrel.com](http://www.micrel.com)



Компания «ЭлектроПласт» предлагает заключение долгосрочных отношений при поставках импортных электронных компонентов на взаимовыгодных условиях!

Наши преимущества:

- Оперативные поставки широкого спектра электронных компонентов отечественного и импортного производства напрямую от производителей и с крупнейших мировых складов;
- Поставка более 17-ти миллионов наименований электронных компонентов;
- Поставка сложных, дефицитных, либо снятых с производства позиций;
- Оперативные сроки поставки под заказ (от 5 рабочих дней);
- Экспресс доставка в любую точку России;
- Техническая поддержка проекта, помощь в подборе аналогов, поставка прототипов;
- Система менеджмента качества сертифицирована по Международному стандарту ISO 9001;
- Лицензия ФСБ на осуществление работ с использованием сведений, составляющих государственную тайну;
- Поставка специализированных компонентов (Xilinx, Altera, Analog Devices, Intersil, Interpoint, Microsemi, Aeroflex, Peregrine, Syfer, Eurofarad, Texas Instrument, Miteq, Cobham, E2V, MA-COM, Hittite, Mini-Circuits, General Dynamics и др.);

Помимо этого, одним из направлений компании «ЭлектроПласт» является направление «Источники питания». Мы предлагаем Вам помощь Конструкторского отдела:

- Подбор оптимального решения, техническое обоснование при выборе компонента;
- Подбор аналогов;
- Консультации по применению компонента;
- Поставка образцов и прототипов;
- Техническая поддержка проекта;
- Защита от снятия компонента с производства.



#### Как с нами связаться

**Телефон:** 8 (812) 309 58 32 (многоканальный)

**Факс:** 8 (812) 320-02-42

**Электронная почта:** [org@eplast1.ru](mailto:org@eplast1.ru)

**Адрес:** 198099, г. Санкт-Петербург, ул. Калинина, дом 2, корпус 4, литера А.