

Converter - Brake - Inverter Module

XPT IGBT

Three Phase Rectifier	Brake Chopper	Three Phase Inverter
$V_{RRM} = 1600 \text{ V}$	$V_{CES} = 1200 \text{ V}$	$V_{CES} = 1200 \text{ V}$
$I_{DAVM25} = 150 \text{ A}$	$I_{C25} = 17 \text{ A}$	$I_{C25} = 28 \text{ A}$
$I_{FSM} = 320 \text{ A}$	$V_{CE(sat)} = 1.8 \text{ V}$	$V_{CE(sat)} = 1.8 \text{ V}$

Part name (Marking on product)

MIXA20WB1200TML

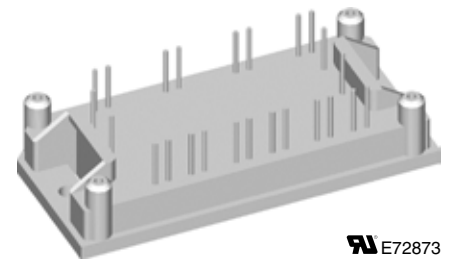
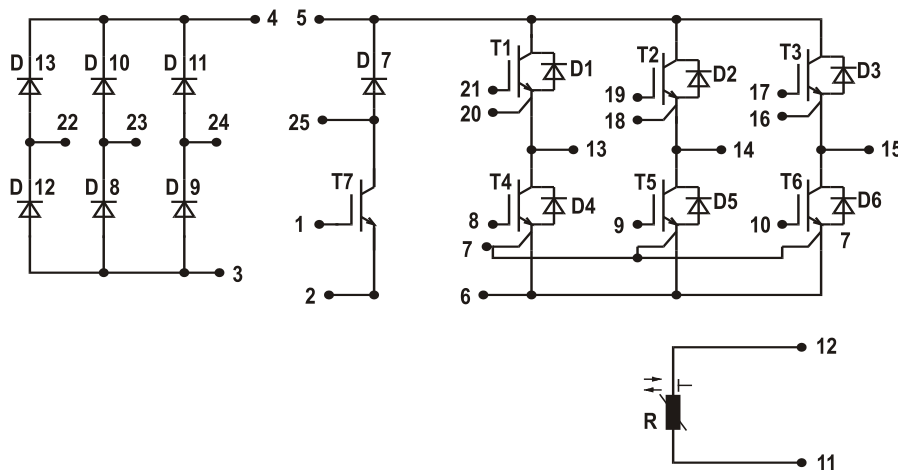

E72873

Pin configuration see outlines.

Features:

- High level of integration - only one power semiconductor module required for the whole drive
- Rugged XPT design (Xtreme light Punch Through) results in:
 - short circuit rated for 10 μsec .
 - very low gate charge
 - square RBSOA @ $3 \times I_c$
 - low EMI
- Thin wafer technology combined with the XPT design results in a competitive low $V_{CE(sat)}$
- Temperature sense included
- SONIC™ diode
 - fast and soft reverse recovery
 - low operating forward voltage

Application:

- AC motor drives
- Pumps, Fans
- Washing machines
- Air-conditioning system
- Inverter and power supplies

Package:

- DCB based "E1-Pack"
- Assembly height is 17 mm
- Insulated base plate
- UL registered E72873

Output Inverter T1 - T6

Symbol	Definitions	Conditions	Ratings			Unit	
			min.	typ.	max.		
V_{CES}	collector emitter voltage		$T_{VJ} = 25^{\circ}\text{C}$		1200	V	
V_{GES}	max. DC gate voltage	continuous			± 20	V	
V_{GEM}	max. transient collector gate voltage	transient			± 30	V	
I_{C25}	collector current		$T_C = 25^{\circ}\text{C}$		28	A	
I_{C80}			$T_C = 80^{\circ}\text{C}$		20	A	
P_{tot}	total power dissipation		$T_C = 25^{\circ}\text{C}$		100	W	
$V_{CE(sat)}$	collector emitter saturation voltage	$I_C = 16\text{ A}; V_{GE} = 15\text{ V}$	$T_{VJ} = 25^{\circ}\text{C}$ $T_{VJ} = 125^{\circ}\text{C}$	1.8 2.1	2.1	V V	
$V_{GE(th)}$	gate emitter threshold voltage	$I_C = 0.6\text{ mA}; V_{GE} = V_{CE}$	$T_{VJ} = 25^{\circ}\text{C}$	5.5	6.0	6.5	V
I_{CES}	collector emitter leakage current	$V_{CE} = V_{CES}; V_{GE} = 0\text{ V}$	$T_{VJ} = 25^{\circ}\text{C}$ $T_{VJ} = 125^{\circ}\text{C}$	0.02 0.2	0.2	mA mA	
I_{GES}	gate emitter leakage current	$V_{GE} = \pm 20\text{ V}$			500	nA	
$Q_{G(on)}$	total gate charge	$V_{CE} = 600\text{ V}; V_{GE} = 15\text{ V}; I_C = 15\text{ A}$			48	nC	
$t_{d(on)}$	turn-on delay time	inductive load $V_{CE} = 600\text{ V}; I_C = 15\text{ A}$ $V_{GE} = \pm 15\text{ V}; R_G = 56\ \Omega$	$T_{VJ} = 125^{\circ}\text{C}$		70	ns	
t_r	current rise time				40	ns	
$t_{d(off)}$	turn-off delay time				250	ns	
t_f	current fall time				100	ns	
E_{on}	turn-on energy per pulse				1.55	mJ	
E_{off}	turn-off energy per pulse				1.7	mJ	
RBSOA	reverse bias safe operating area	$V_{GE} = \pm 15\text{ V}; R_G = 56\ \Omega; V_{CEK} = 1200\text{ V}$	$T_{VJ} = 125^{\circ}\text{C}$		45	A	
I_{SC} (SCSOA)	short circuit safe operating area	$V_{CE} = 900\text{ V}; V_{GE} = \pm 15\text{ V};$ $R_G = 56\ \Omega; t_p = 10\ \mu\text{s};$ non-repetitive	$T_{VJ} = 125^{\circ}\text{C}$		60	A	
R_{thJC}	thermal resistance junction to case	(per IGBT)			1.26	K/W	
R_{thCH}	thermal resistance case to heatsink			0.42		K/W	

Output Inverter D1 - D6

Symbol	Definitions	Conditions	Ratings			Unit
			min.	typ.	max.	
V_{RRM}	max. repetitive reverse voltage		$T_{VJ} = 25^{\circ}\text{C}$		1200	V
I_{F25}	forward current		$T_C = 25^{\circ}\text{C}$		33	A
I_{F80}			$T_C = 80^{\circ}\text{C}$		22	A
V_F	forward voltage	$I_F = 20\text{ A}; V_{GE} = 0\text{ V}$	$T_{VJ} = 25^{\circ}\text{C}$ $T_{VJ} = 125^{\circ}\text{C}$	1.95 1.95	2.2	V V
Q_{rr}	reverse recovery charge	$V_R = 600\text{ V}$ $di_F/dt = -400\text{ A}/\mu\text{s}$ $I_F = 20\text{ A}; V_{GE} = 0\text{ V}$	$T_{VJ} = 125^{\circ}\text{C}$		3	μC
I_{RM}	max. reverse recovery current				20	A
t_{rr}	reverse recovery time				350	ns
E_{rec}	reverse recovery energy				0.7	mJ
R_{thJC}	thermal resistance junction to case	(per diode)			1.5	K/W
R_{thCH}	thermal resistance case to heatsink			0.5		K/W

Brake T7

Symbol	Definitions	Conditions	Ratings			Unit	
			min.	typ.	max.		
V_{CES}	collector emitter voltage	$T_{VJ} = 25^{\circ}\text{C}$			1200	V	
V_{GES}	max. DC gate voltage	continuous			± 20	V	
V_{GEM}	max. transient collector gate voltage	transient			± 30	V	
I_{C25}	collector current	$T_C = 25^{\circ}\text{C}$			17	A	
I_{C80}		$T_C = 80^{\circ}\text{C}$			12	A	
P_{tot}	total power dissipation	$T_C = 25^{\circ}\text{C}$			63	W	
$V_{CE(sat)}$	collector emitter saturation voltage	$I_C = 9\text{ A}; V_{GE} = 15\text{ V}$			1.8 2.1	V V	
$V_{GE(th)}$	gate emitter threshold voltage	$I_C = 0.3\text{ mA}; V_{GE} = V_{CE}$	$T_{VJ} = 25^{\circ}\text{C}$	5.5	6.0	6.5	V
I_{CES}	collector emitter leakage current	$V_{CE} = V_{CES}; V_{GE} = 0\text{ V}$	$T_{VJ} = 25^{\circ}\text{C}$ $T_{VJ} = 125^{\circ}\text{C}$		0.01 0.1	0.1	mA mA
I_{GES}	gate emitter leakage current	$V_{GE} = \pm 20\text{ V}$				500	nA
$Q_{G(on)}$	total gate charge	$V_{CE} = 600\text{ V}; V_{GE} = 15\text{ V}; I_C = 10\text{ A}$			27		nC
$t_{d(on)}$	turn-on delay time	inductive load $V_{CE} = 600\text{ V}; I_C = 10\text{ A}$ $V_{GE} = \pm 15\text{ V}; R_G = 100\ \Omega$	$T_{VJ} = 125^{\circ}\text{C}$		70		ns
t_r	current rise time				40		ns
$t_{d(off)}$	turn-off delay time				250		ns
t_f	current fall time				100		ns
E_{on}	turn-on energy per pulse				1.1		mJ
E_{off}	turn-off energy per pulse				1.1		mJ
RBSOA	reverse bias safe operating area	$V_{GE} = \pm 15\text{ V}; R_G = 100\ \Omega; V_{CEK} = 1200\text{ V}$				30	A
			$T_{VJ} = 125^{\circ}\text{C}$				
I_{SC} (SCSOA)	short circuit safe operating area	$V_{CE} = 900\text{ V}; V_{GE} = \pm 15\text{ V};$ $R_G = 100\ \Omega; t_p = 10\ \mu\text{s};$ non-repetitive	$T_{VJ} = 125^{\circ}\text{C}$		40		A
R_{thJC}	thermal resistance junction to case	(per IGBT)				2.0	K/W
R_{thCH}	thermal resistance case to heatsink				0.7		K/W

Brake Chopper D7

Symbol	Definitions	Conditions	Ratings			Unit	
			min.	typ.	max.		
V_{RRM}	max. repetitive reverse voltage	$T_{VJ} = 150^{\circ}\text{C}$			1200	V	
I_{F25}	forward current	$T_C = 25^{\circ}\text{C}$			33	A	
I_{F80}		$T_C = 80^{\circ}\text{C}$			22	A	
V_F	forward voltage	$I_F = 20\text{ A}; V_{GE} = 0\text{ V}$	$T_{VJ} = 25^{\circ}\text{C}$ $T_{VJ} = 125^{\circ}\text{C}$		1.95 1.95	2.2	V V
I_R	reverse current	$V_R = V_{RRM}$	$T_{VJ} = 25^{\circ}\text{C}$ $T_{VJ} = 125^{\circ}\text{C}$		0.01 0.1	0.1	mA mA
Q_{rr}	reverse recovery charge	$V_R = 600\text{ V}$ $di_F/dt = 400\text{ A}/\mu\text{s}$ $I_F = 20\text{ A}; V_{GE} = 0\text{ V}$	$T_{VJ} = 125^{\circ}\text{C}$		3		μC
I_{RM}	max. reverse recovery current				20		A
t_{rr}	reverse recovery time				350		ns
E_{rec}	reverse recovery energy				0.7		mJ
R_{thJC}	thermal resistance junction to case	(per diode)				1.5	K/W
R_{thCH}	thermal resistance case to heatsink				0.5		K/W

Input Rectifier Bridge D8 - D11

Symbol	Definitions	Conditions	Ratings			Unit
			min.	typ.	max.	
V_{RRM}	max. repetitive reverse voltage		$T_{VJ} = 25^{\circ}\text{C}$		1600	V
I_{FAV}	average forward current	sine 180°	$T_C = 80^{\circ}\text{C}$		37	A
I_{DAVM}	max. average DC output current	rect.; $d = 1/3$	$T_C = 80^{\circ}\text{C}$		105	A
I_{FSM}	max. forward surge current	$t = 10\text{ ms}$; sine 50 Hz	$T_{VJ} = 25^{\circ}\text{C}$ $T_{VJ} = 125^{\circ}\text{C}$		320 280	A A
I^2t	I^2t value for fusing	$t = 10\text{ ms}$; sine 50 Hz	$T_{VJ} = 25^{\circ}\text{C}$ $T_{VJ} = 125^{\circ}\text{C}$		510 390	A^2s A^2s
P_{tot}	total power dissipation		$T_C = 25^{\circ}\text{C}$		110	W
V_F	forward voltage	$I_F = 50\text{ A}$	$T_{VJ} = 25^{\circ}\text{C}$ $T_{VJ} = 125^{\circ}\text{C}$	1.36 1.36	1.7	V V
I_R	reverse current	$V_R = V_{RRM}$	$T_{VJ} = 25^{\circ}\text{C}$ $T_{VJ} = 125^{\circ}\text{C}$	0.2	0.02	mA mA
R_{thJC}	thermal resistance junction to case	(per diode)		0.36	1.1	K/W
R_{thCH}	thermal resistance case to heatsink	(per diode)				K/W

Temperature Sensor NTC

Symbol	Definitions	Conditions	Ratings			Unit
			min.	typ.	max.	
R_{25}	resistance		$T_C = 25^{\circ}\text{C}$	4.45	4.7	$\text{k}\Omega$
$B_{25/50}$					3510	K

Module

Symbol	Definitions	Conditions	Ratings			Unit
			min.	typ.	max.	
T_{VJ}	operating temperature		-40		125	$^{\circ}\text{C}$
T_{VJM}	max. virtual junction temperature				150	$^{\circ}\text{C}$
T_{stg}	storage temperature		-40		125	$^{\circ}\text{C}$
V_{ISOL}	isolation voltage	$I_{ISOL} \leq 1\text{ mA}$; 50/60 Hz			2500	V~
CTI	comparative tracking index				-	
M_d	mounting torque	(M4)	2.0		2.2	Nm
d_s	creep distance on surface		12.7			mm
d_A	strike distance through air		7.6			mm
Weight				40		g

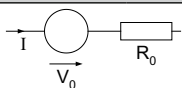
Equivalent Circuits for Simulation

Symbol	Definitions	Conditions	Ratings			Unit
			min.	typ.	max.	
V_0	rectifier diode	D8 - D13	$T_{VJ} = 150^{\circ}\text{C}$		0.88	V
R_0					9.0	$\text{m}\Omega$
V_0	IGBT	T1 - T6	$T_{VJ} = 150^{\circ}\text{C}$		1.1	V
R_0					86.3	$\text{m}\Omega$
V_0	free wheeling diode	D1 - D6	$T_{VJ} = 150^{\circ}\text{C}$		1.19	V
R_0					40.0	$\text{m}\Omega$
V_0	IGBT	T7	$T_{VJ} = 150^{\circ}\text{C}$		1.1	V
R_0					153	$\text{m}\Omega$
V_0	free wheeling diode	D7	$T_{VJ} = 150^{\circ}\text{C}$		1.19	V
R_0					40	$\text{m}\Omega$

Circuit Diagram

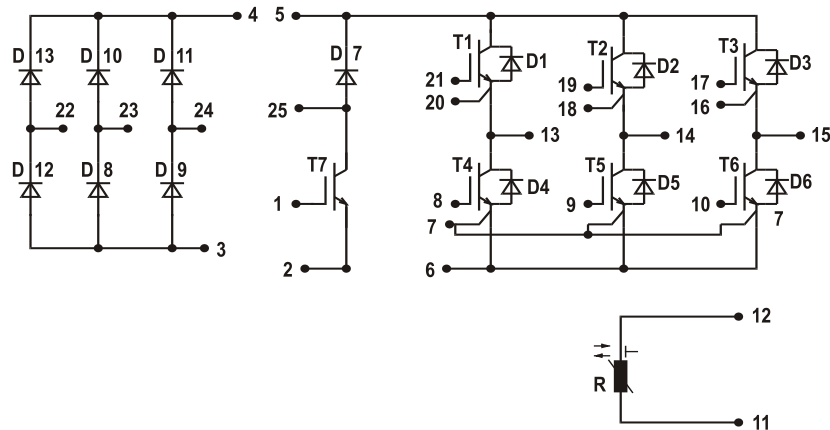

Outline Drawing

Dimensions in mm (1 mm = 0.0394")

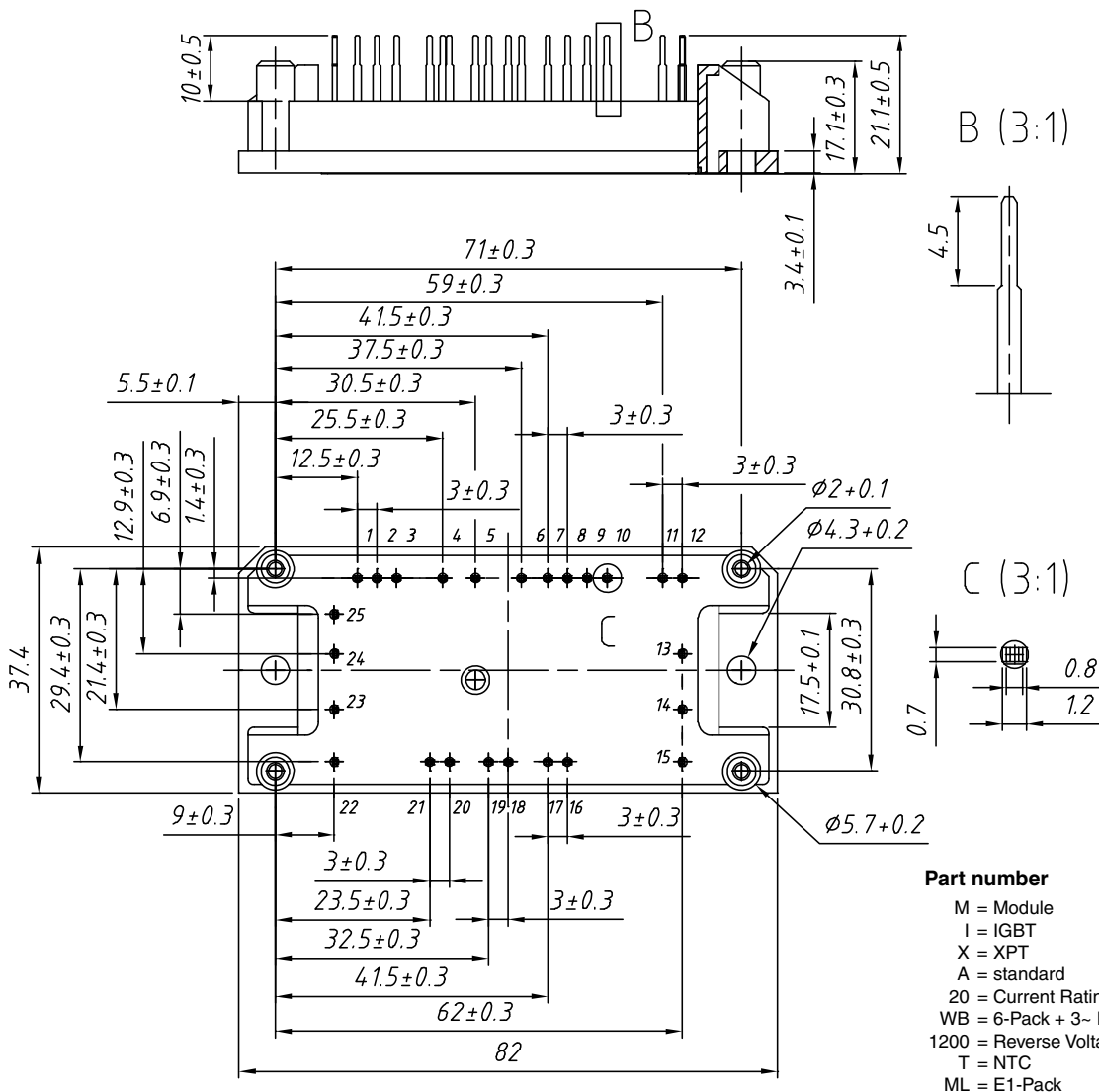

Part number
 M = Module
 I = IGBT
 X = XPT
 A = standard
 20 = Current Rating [A]
 WB = 6-Pack + 3~ Rectifier Bridge & Brake Unit
 1200 = Reverse Voltage [V]
 T = NTC
 ML = E1-Pack

Ordering	Part Name	Marking on Product	Delivering Mode	Base Qty	Ordering Code
Standard	MIXA 20 WB 1200 TML	MIXA20WB1200TML	Box	10	508630

IGBT T1 - T6

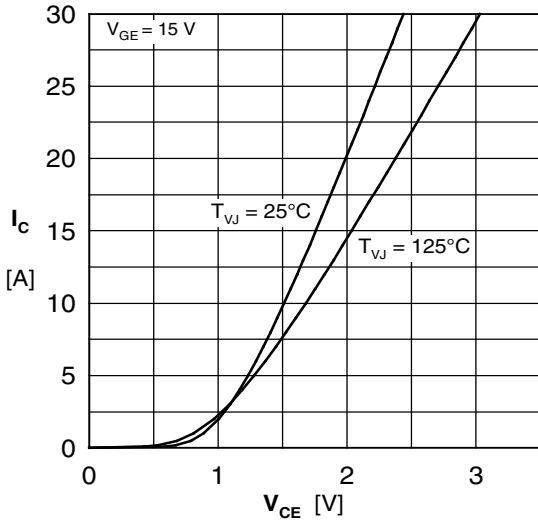

Fig. 1 Typ. output characteristics

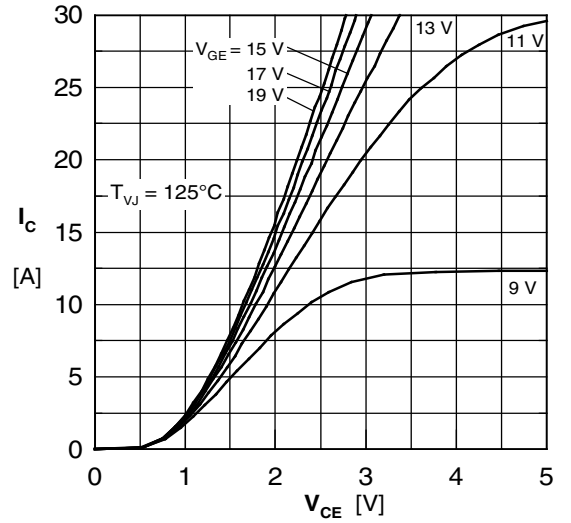

Fig. 2 Typ. output characteristics

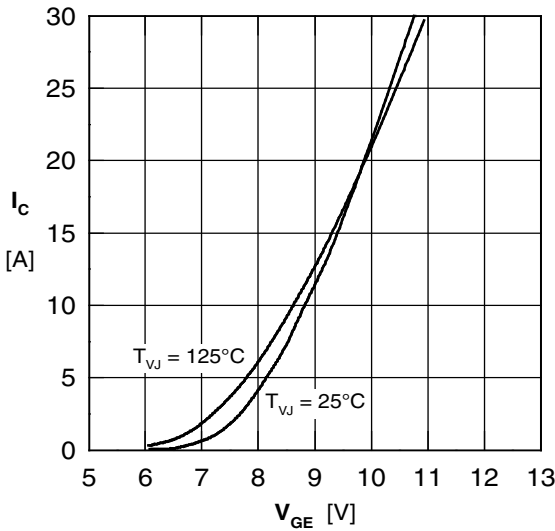

Fig. 3 Typ. transfer characteristics

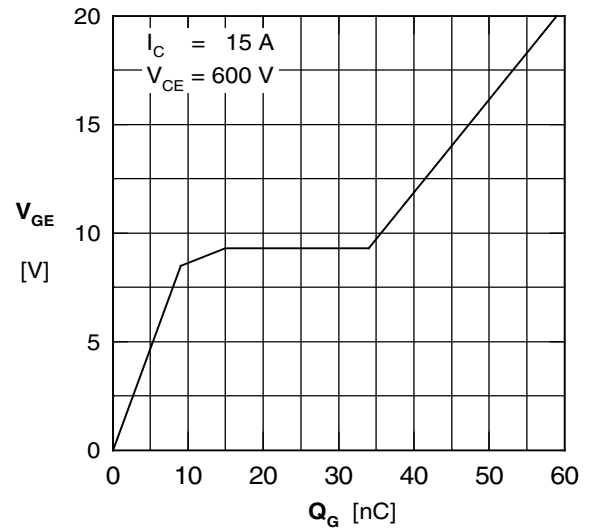

Fig. 4 Typ. turn-on gate charge

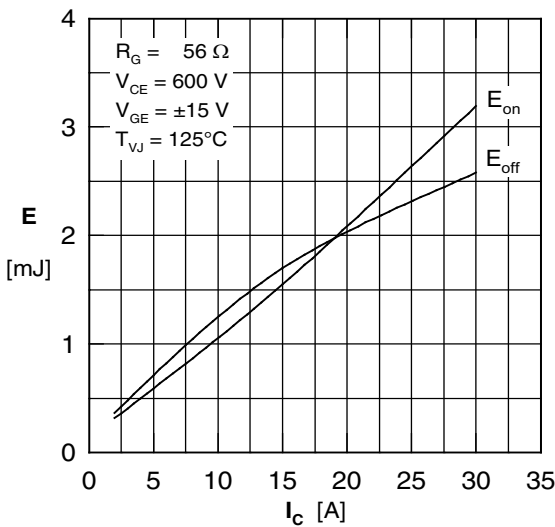

Fig. 5 Typ. switching energy vs. collector current

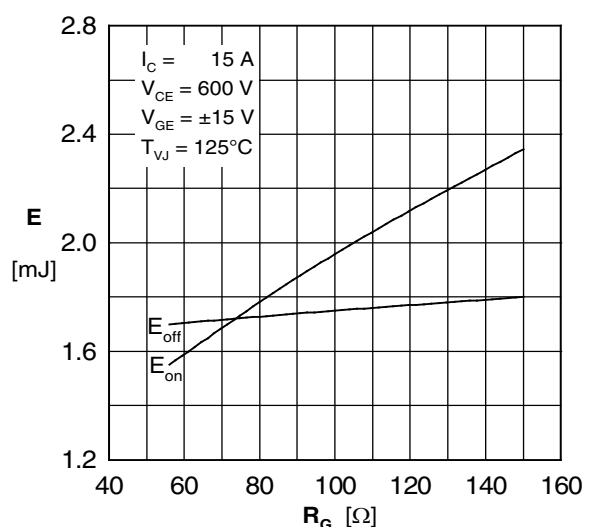

Fig. 6 Typ. switching energy vs. gate resistance

Diode D1 - D6

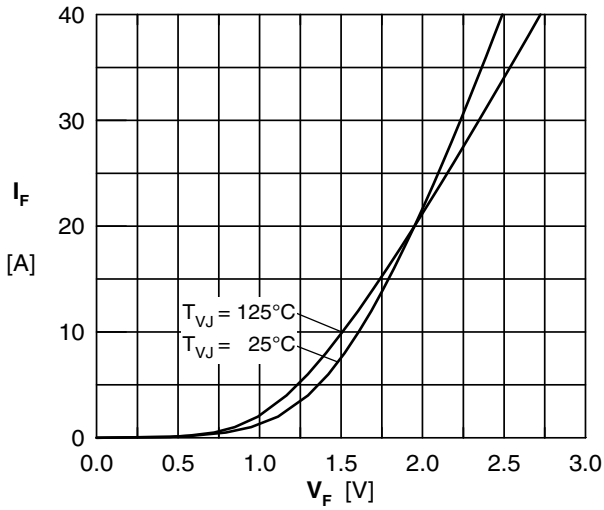

Fig. 7 Typ. Forward current versus V_F

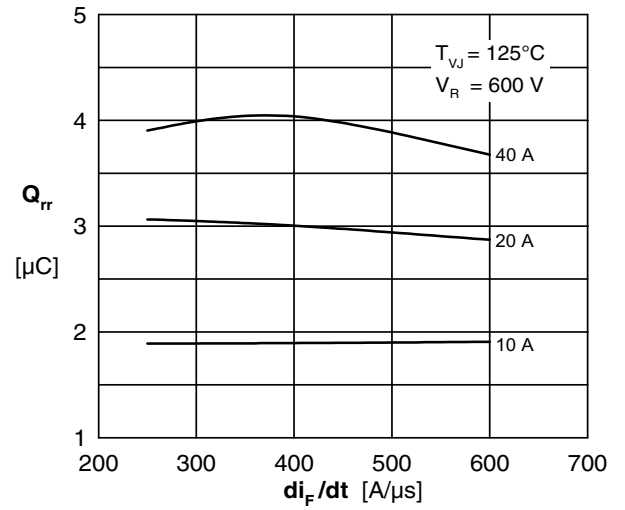

Fig. 8 Typ. reverse recov.charge Q_{rr} vs. di/dt

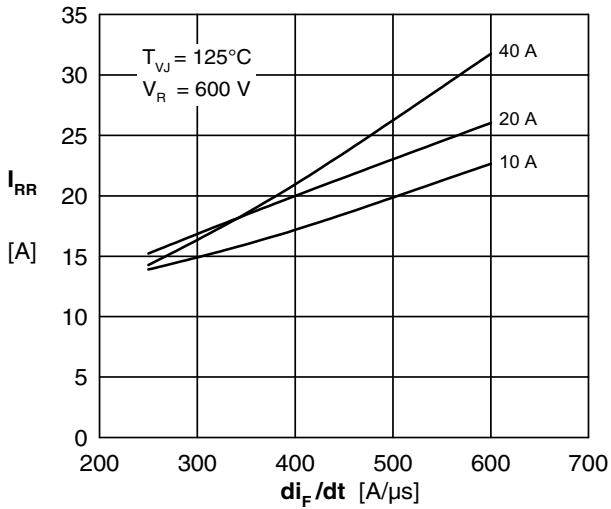

Fig. 9 Typ. peak reverse current I_{RRM} vs. di/dt

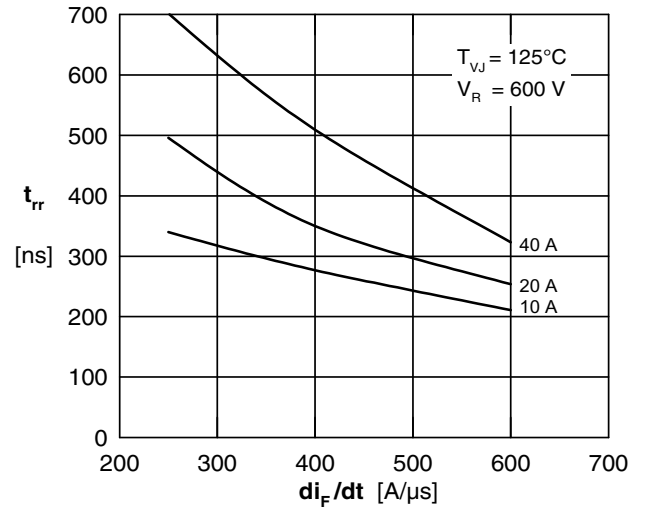

Fig. 10 Typ. recovery time t_{rr} versus di/dt

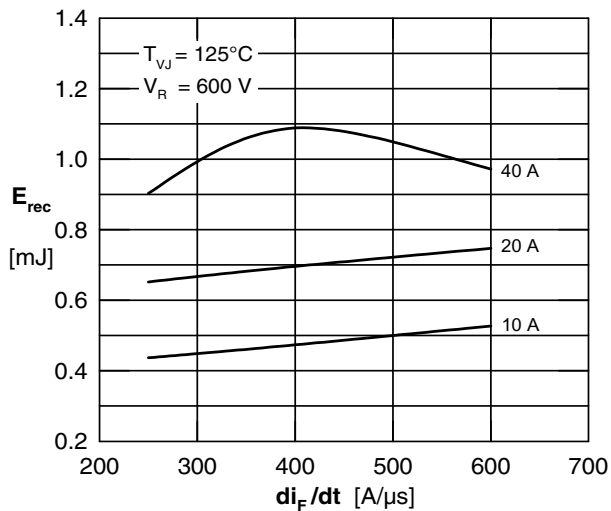

Fig. 11 Typ. recovery energy E_{rec} versus di/dt

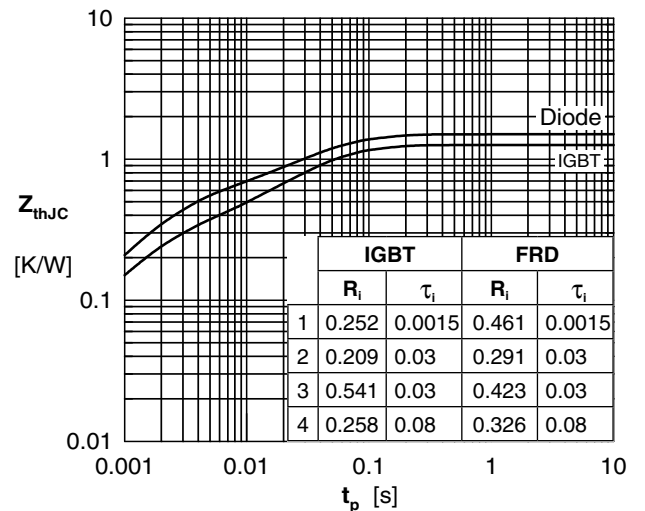

Fig. 12 Typ. transient thermal impedance

NTC

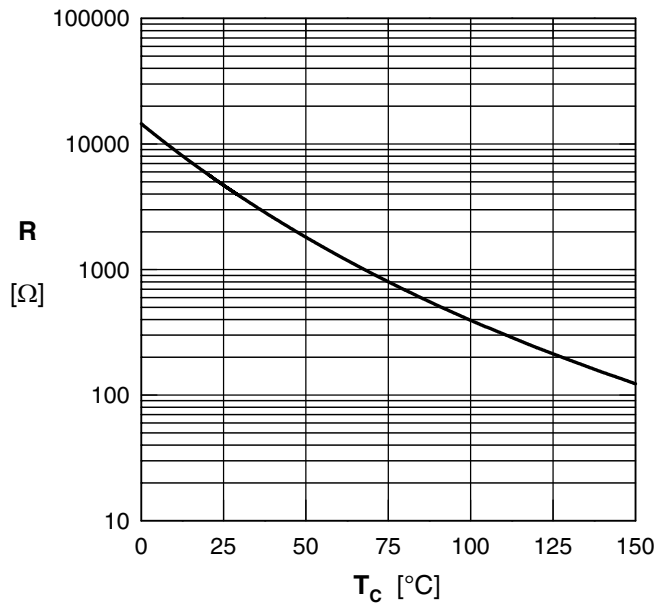

Fig. 13 Typ. thermistor resistance vs. temperature



Компания «ЭлектроПласт» предлагает заключение долгосрочных отношений при поставках импортных электронных компонентов на взаимовыгодных условиях!

Наши преимущества:

- Оперативные поставки широкого спектра электронных компонентов отечественного и импортного производства напрямую от производителей и с крупнейших мировых складов;
- Поставка более 17-ти миллионов наименований электронных компонентов;
- Поставка сложных, дефицитных, либо снятых с производства позиций;
- Оперативные сроки поставки под заказ (от 5 рабочих дней);
- Экспресс доставка в любую точку России;
- Техническая поддержка проекта, помощь в подборе аналогов, поставка прототипов;
- Система менеджмента качества сертифицирована по Международному стандарту ISO 9001;
- Лицензия ФСБ на осуществление работ с использованием сведений, составляющих государственную тайну;
- Поставка специализированных компонентов (Xilinx, Altera, Analog Devices, Intersil, Interpoint, Microsemi, Aeroflex, Peregrine, Syfer, Eurofarad, Texas Instrument, Miteq, Cobham, E2V, MA-COM, Hittite, Mini-Circuits, General Dynamics и др.);

Помимо этого, одним из направлений компании «ЭлектроПласт» является направление «Источники питания». Мы предлагаем Вам помощь Конструкторского отдела:

- Подбор оптимального решения, техническое обоснование при выборе компонента;
- Подбор аналогов;
- Консультации по применению компонента;
- Поставка образцов и прототипов;
- Техническая поддержка проекта;
- Защита от снятия компонента с производства.



Как с нами связаться

Телефон: 8 (812) 309 58 32 (многоканальный)

Факс: 8 (812) 320-02-42

Электронная почта: org@eplast1.ru

Адрес: 198099, г. Санкт-Петербург, ул. Калинина, дом 2, корпус 4, литера А.