

General Specifications

Electrical Capacity (Resistive Load)

Power Level (silver):	3A @ 125V AC
Logic Level (gold):	0.4VA maximum @ 28V AC/DC maximum (Applicable Range 0.1mA ~ 0.1A @ 20mV ~ 28V)
Logic/Power Level: (gold over silver)	Combines silver & gold ratings
	Note: Find additional explanation of dual rating & operating range in Supplement section.

Other Ratings

Contact Resistance:	20 milliohms maximum for silver; 30 milliohms maximum for gold
Insulation Resistance:	1,000 megohms minimum @ 500V DC
Dielectric Strength:	1,000V AC minimum between contacts for 1 minute minimum; 1,500V AC minimum between contacts & case for 1 minute minimum
Mechanical Life:	200,000 operations minimum
Electrical Life:	25,000 operations minimum for silver; 100,000 operations minimum for gold
Nominal Operating Force:	Single pole 2.45N; double pole 3.92N
Travel	Pretravel .024" (0.6mm); Overtravel .016" (0.4mm); Total Travel .039" (1.0mm)

Materials & Finishes

Plunger:	Brass with nickel plating
Bushing:	Brass with nickel plating
Frame:	Stainless steel
Case:	Polybutylene terephthalate (PBT) (UL94V-0)
Base:	Diallyl phthalate resin (UL94V-0)
Movable Contactor:	Phosphor bronze with silver or gold plating
Movable Contacts:	Silver alloy (code W); copper with gold plating (code G); or silver alloy with gold plating (code A)
Stationary Contacts:	Silver alloy with silver plating (code W); copper or brass with gold plating (code G); or silver with gold plating (code A)
Terminals:	Copper or brass with silver plating; copper or brass with gold plating

Environmental Data

Operating Temp Range:	-30°C through +85°C (-22°F through +185°F)
Humidity:	90 ~ 95% humidity for 96 hours @ 40°C (104°F)
Vibration:	10 ~ 55Hz with peak-to-peak amplitude of 1.5mm traversing the frequency range & returning in 1 minute; 3 right angled directions for 2 hours
Shock:	50G (490m/s ²) acceleration (tested in 6 right angled directions, with 3 shocks in each direction)

Installation

Mounting Torque:	1.5Nm (13.0 lb•in) for double nut; 0.7Nm (6.0 lb•in) for single nut
Cap Installation Force:	80.0N (18.0 lbf) maximum downward force on actuator
Soldering:	Wave Soldering (PC version): See Profile B in Supplement section. Manual Soldering: See Profile B in Supplement section.
Cleaning:	These devices are not process sealed. Hand clean locally using alcohol based solution. See Cleaning Specifications in Supplement section.

Standards & Certifications

Flammability Standards:	UL94V-0 case & base
UL:	File No. E44145 - Recognized only when ordered with marking on switch. Add "/U" or "/CUL" before dash in part number to order UL recognized switch. All single and double pole models recognized at 3A @ 125V AC or 0.4VA max. @ 28V DC max.
CSA:	File No. 023535_0_000 - Certified only when ordered with marking on switch. Add "/C" before dash in part number to order CSA certified switch. Single pole models with PC, solder lug, or Wirewrap terminals & double pole with PC or Wirewrap terminals certified at 3A @ 125V AC or 0.4VA @ 28V maximum.

Distinctive Characteristics

Snap-acting mechanism gives smooth actuation, short stroke, light touch, and audible feedback. This mechanism also provides long mechanical life.

High torque bushing construction prevents rotation or separation from frame during installation.

Antijamming design protects contacts from damage due to excessive downward force on the actuator.

Compatible companions with M series toggles. Body, bushing, and footprint dimensions ideal for mounting MB2400 pushbuttons and M toggles next to one another.

Stainless steel frame resists corrosion.

Longer center solder lug terminal simplifies wiring and soldering.

Silver contacts of specially composed alloy for hardness.

Epoxy sealed terminals prevent entry of solder flux and other contaminants.

Prominent external insulating barriers increase insulation resistance and dielectric strength.

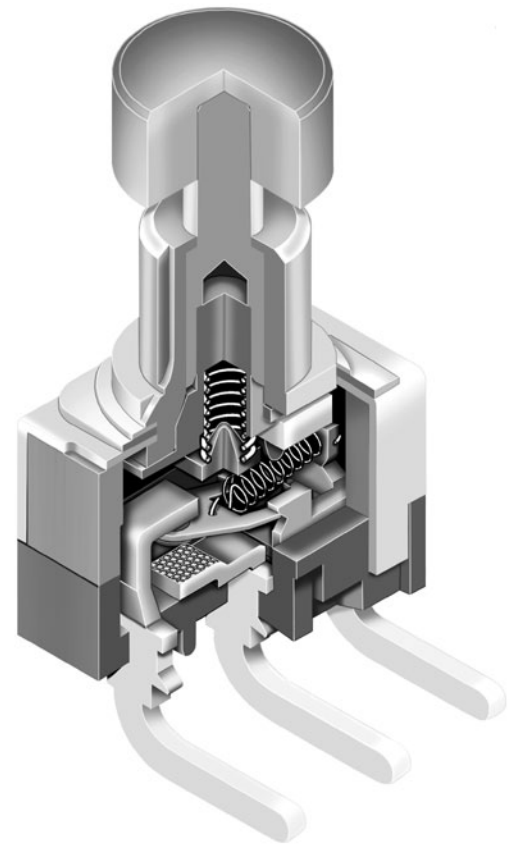

Actual Size

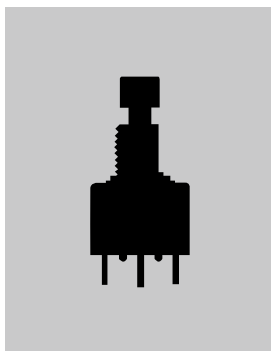

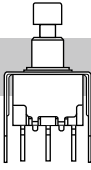
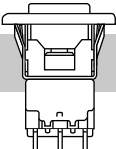
	Bushing Mount	Page C98
	Bracket PC Mount	Page C102
	Snap-in Mount	Page C108

- Toggle
- Rockers
- Pushbuttons**
- Illuminated PB
- Programmable
- Keylocks
- Rotaries
- Slides
- Tactiles
- Tilt
- Touch
- Indicators
- Accessories
- Supplement

TYPICAL SWITCH ORDERING EXAMPLE

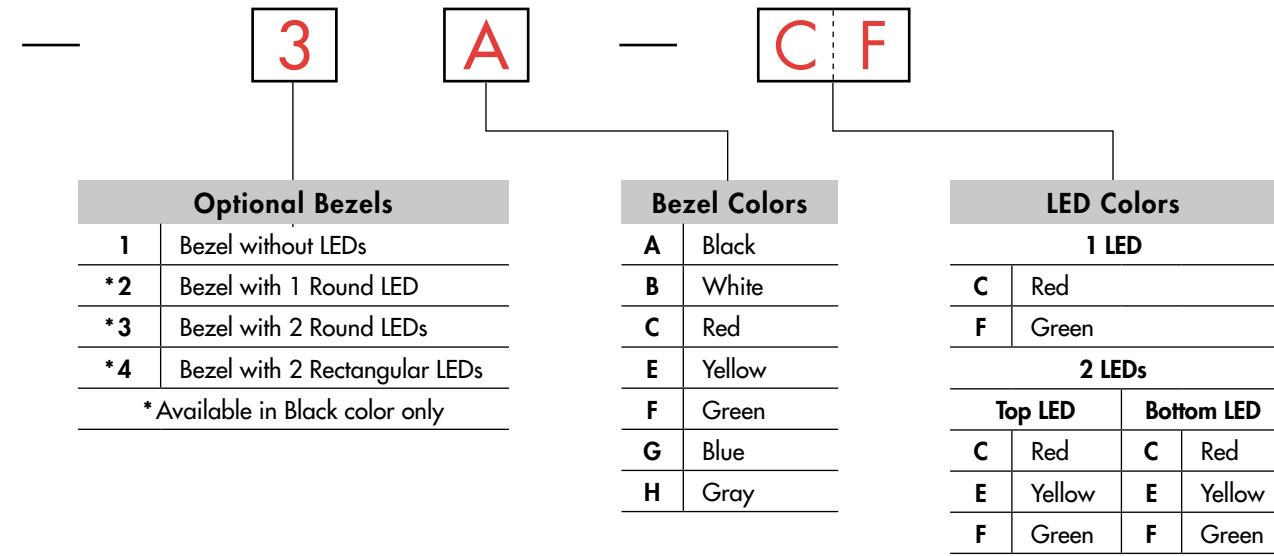
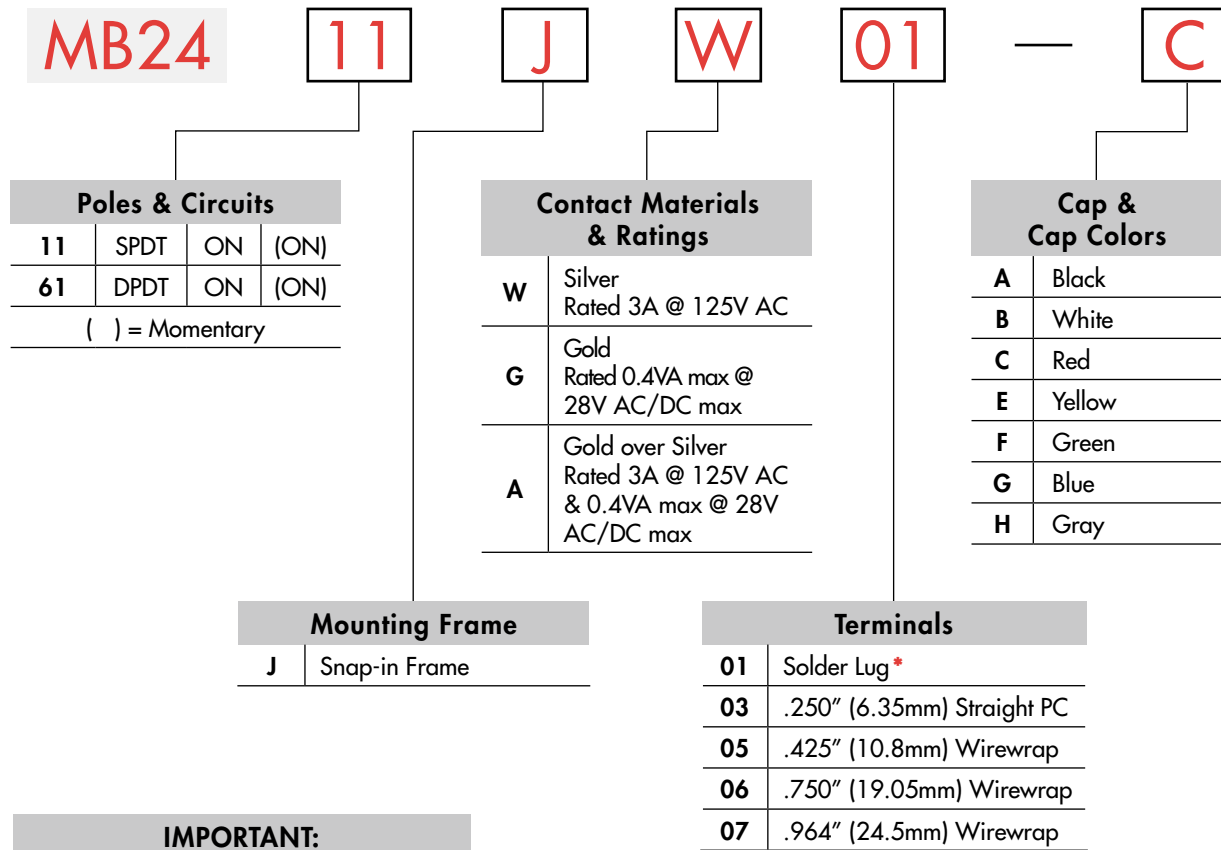

IMPORTANT:



Switches are supplied without UL, cULus & CSA marking unless specified. **UL, cULus & CSA recognized only when ordered with marking on the switch.** Specific models, ratings, & ordering instructions are noted on General Specifications page.

* Wire harness & cable assemblies offered only in Americas

DESCRIPTION FOR TYPICAL ORDERING EXAMPLE

MB2411JW01-C

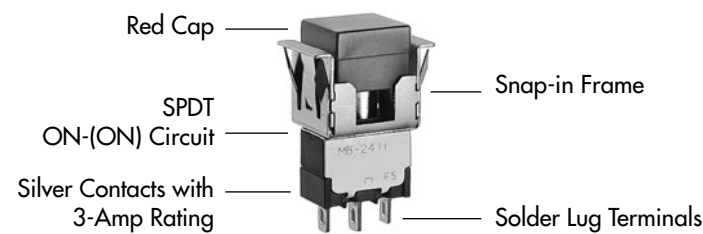

DESCRIPTION FOR TYPICAL ORDERING EXAMPLE

MB2411JW01-C-3A-CF

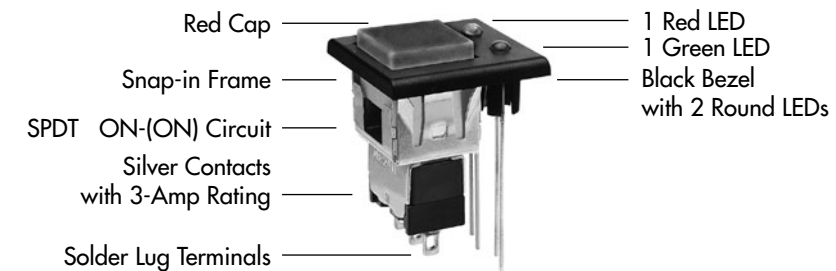

Toggles

Rockers

Pushbuttons

Illuminated PB

Programmable

Keylocks

Rotaries

Slides

Tactiles

Tilt

Touch

Indicators

Accessories

Supplement

POLES & CIRCUITS

		Plunger Position () = Momentary		Connected Terminals		Throw & Switch Schematics
Pole	Model	Normal	Down	Normal	Down	
SP	MB2411	ON	(ON)	1-3	1-2	SPDT
DP	MB2461	ON	(ON)	1-3 4-6	1-2 4-5	DPDT

Note: Terminal numbers are not actually on the switch.

MOUNTING FRAME

J

Snap-in Frame

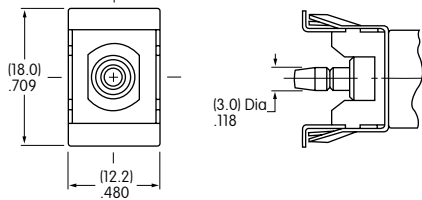

Panel Cutout for Single Pole without Bezel

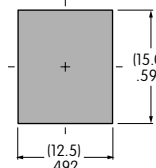

Panel Cutout for Double Pole without Bezel

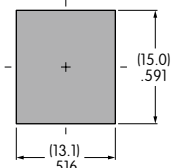

Panel Thickness without Bezel: .039" ~ .157" (1.0mm ~ 4.0mm)
 Panel Thickness with Bezel: .039" ~ .126" (1.0mm ~ 3.2mm)

CONTACT MATERIALS & RATINGS

W

Silver over Silver

Power Level

3A @ 125V AC

G

Gold over Brass or Copper

Logic Level

0.4VA maximum @ 28V AC/DC maximum

Note: Complete explanation of operating range in Supplement section.

A

Gold over Silver

Power Level
or Logic Level

3A @ 125V AC
or 0.4VA maximum @ 28V AC/DC maximum

Note: This dual rated option is suitable when two or more identical switches are used in logic and in power circuits within the same application. See Supplement section for complete explanation of dual rating and operating range.

TERMINALS

01

Solder Lug

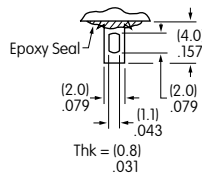

03

.250" (6.35mm)
Straight PC

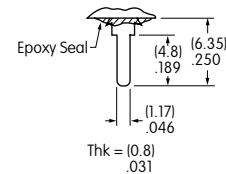

Wirewrap or Extended PC

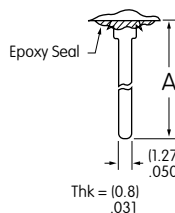

Refer to footprints if using as extended PC terminal.

Dimension A = terminal lengths as shown beside the code boxes at left.

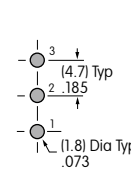

Single Pole

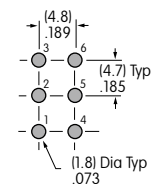

Double Pole

05

.425"
(10.8mm)

06

.750"
(19.05mm)

07

.964"
(24.5mm)

CAP & CAP COLORS

AT465
.453" (11.5mm)
Square Cap

Material: Polycarbonate
 Finish: Glossy

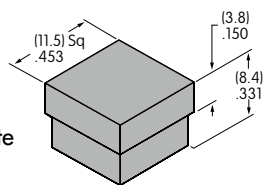

Contact factory for matte finish.

Legend details at end of this section.

A	Black	B	White	C	Red	E	Yellow
F	Green	G	Blue	H	Gray		

OPTIONAL SNAP-IN BEZELS & BEZEL COLORS

1 **AT207 Bezel**

Material: Polycarbonate
 Finish: Glossy

Contact factory for matte finish.

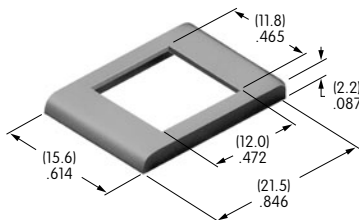

A	Black	F	Green
B	White	G	Blue
C	Red	H	Gray
E	Yellow		

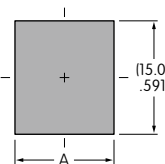

	Single Pole	Double Pole
A	(12.5)mm .492"	(13.1)mm .516"

2 **AT208 Bezel for AT070 LED**

Material: Polycarbonate
 Finish: Glossy

Contact factory for matte finish.

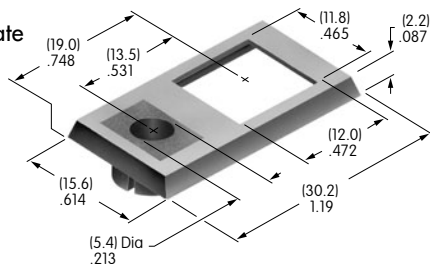

A Black
 LED colors & specifications on next page.

	Single Pole	Double Pole
A	(12.5)mm .492"	(13.1)mm .516"
B	(6.25)mm .246"	(6.55)mm .258"

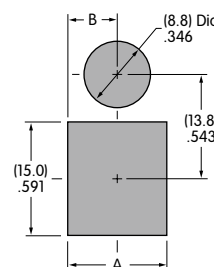

3 **AT212 Bezel for AT617 LED**

Material: Polycarbonate
 Finish: Semi-glossy

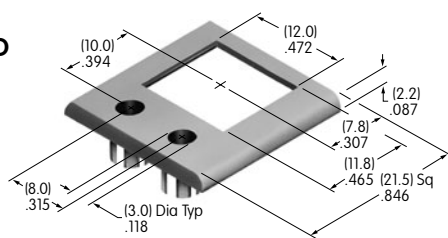

A Black
 LED colors & specifications on next page.

	Single Pole	Double Pole
A	(18.4)mm .724"	(18.7)mm .736"

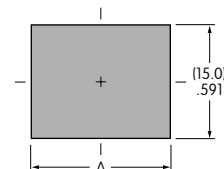

4 **AT213 Bezel for AT618 LED**

Material: Polycarbonate
 Finish: Semi-glossy

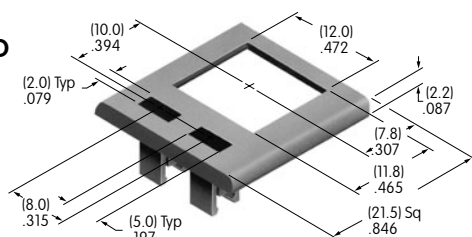

A Black
 LED colors & specifications on next page.

	Single Pole	Double Pole
A	(18.4)mm .724"	(18.7)mm .736"

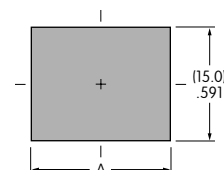

Bezel Assembly

1. Pry out tab on bezel to a 45° angle.

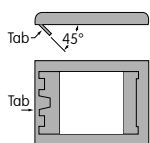

2. Insert switch frame under tab and snap on the bezel.

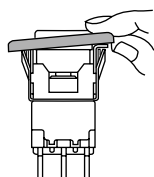

3. Push tab back into place.

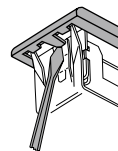

4. Snap assembled bezel and switch into panel.

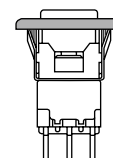

LED COLORS & SPECIFICATIONS

Bezel Orientation on Switch

AT070 LED
For Bezel AT208
with 1 LED

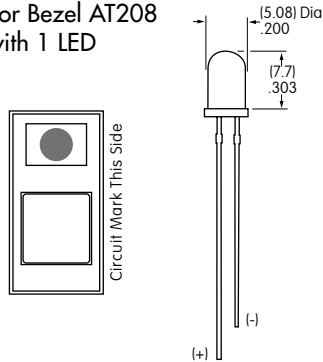

AT617 LED
For Bezel AT212
with 2 Round LEDs

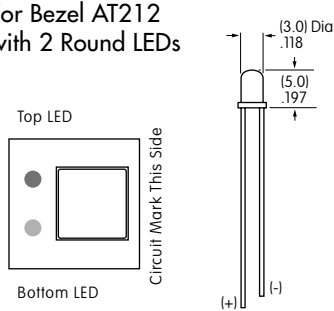

AT618 LED
For Bezel AT213
with 2 Rectangular LEDs

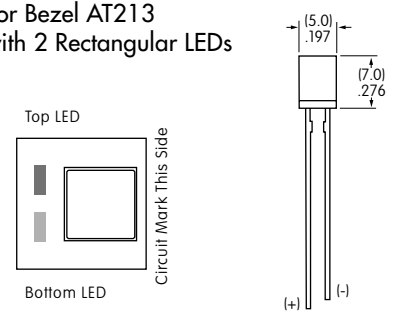

Note: Lead lengths may differ from manufacturing lot to lot. The longer lead is the anode (+).

		AT070		AT617			AT618		
		C	F	C	E	F	C	E	F
	Color	Red	Green	Red	Yellow	Green	Red	Yellow	Green
Forward Peak Current	I_{FM}	25mA	50mA	30mA	30mA	25mA	10mA	30mA	30mA
Typical Forward Current	I_F	20mA	30mA	20mA	20mA	20mA	8mA	24mA	24mA
Forward Voltage	V_F	2.8V	2.1V	2.0V	2.1V	2.2V	1.9V	2.0V	2.1V
Reverse Peak Voltage	V_{RM}	4V	5V	5V	5V	5V	5V	5V	5V
Current Reduction Rate Above 25°C	ΔI_F	0.33 mA/°C	0.40 mA/°C	0.40 mA/°C	0.40 mA/°C	0.33 mA/°C	0.13 mA/°C	0.40 mA/°C	0.40 mA/°C
Ambient Temperature Range (when used with a bezel)		-10° ~ +70°C		-15° ~ +70°C			-15° ~ +70°C		

The electrical specifications shown are determined at a basic temperature of 25°C. LED circuit is independent of switch operation. LED is colored in OFF state.

If the source voltage is greater than the rated voltage of the LED, a ballast resistor must be connected in series with the LED. The ballast resistor calculation and more lamp detail are shown in the Supplement section.

TYPICAL SWITCH DIMENSIONS

Solder Lug

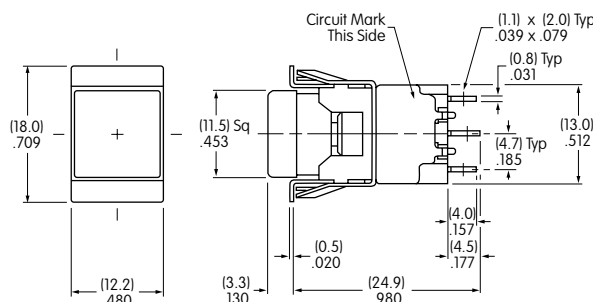

Single Pole

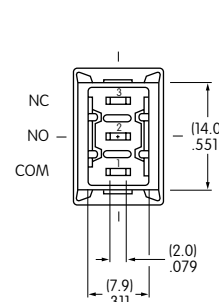

Double Pole

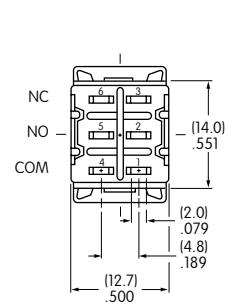

MB2411JW01-C

TYPICAL SWITCH DIMENSIONS

Single & Double Pole

Solder Lug • AT207 Bezel

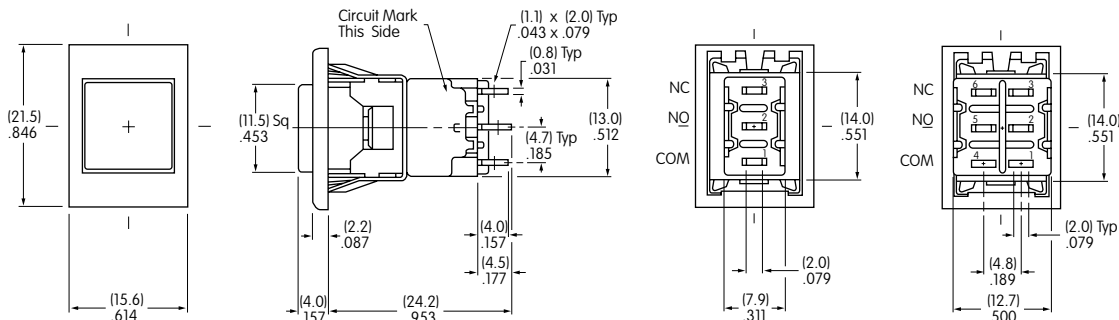

MB2411JW01-C-1A

Single Pole

Solder Lug • AT208 Bezel

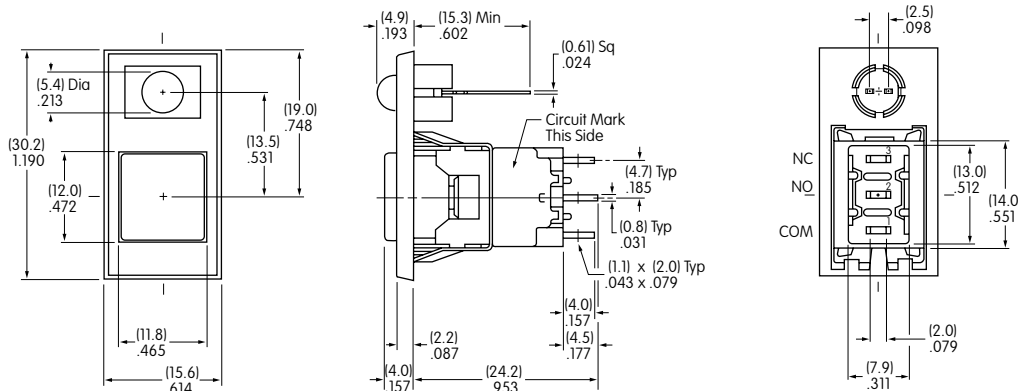

MB2411JW01-C-2A-C

Single Pole

Solder Lug • AT212 Bezel

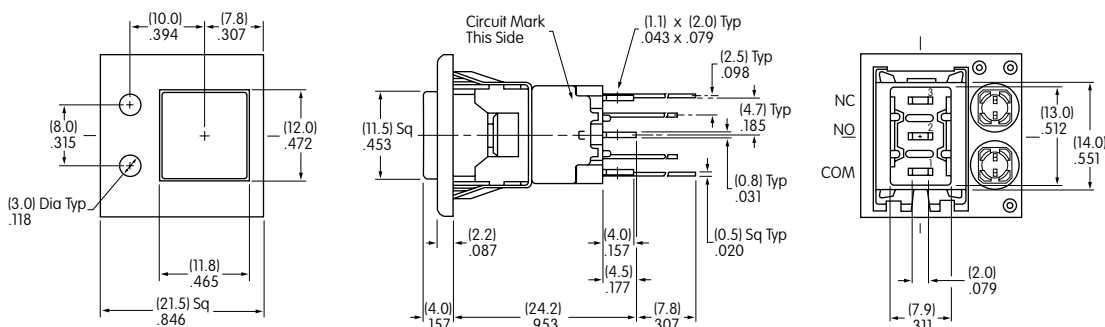

MB2411JW01-C-3A-CF

Double Pole

Solder Lug • AT213 Bezel

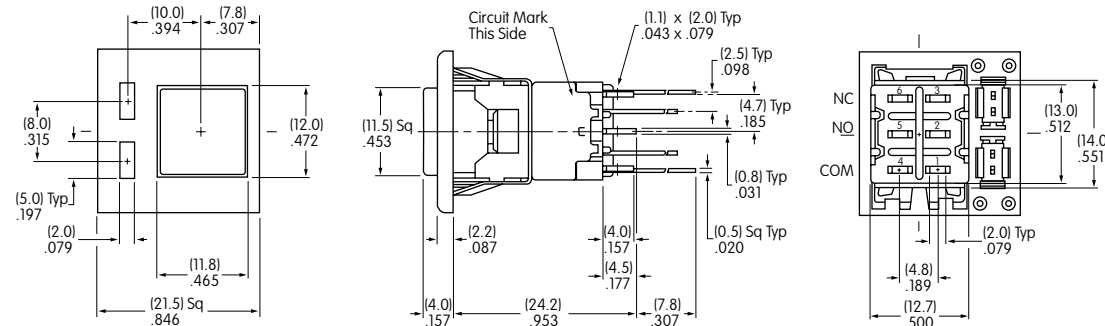

MB2461JW01-C-4A-CF

LEGENDS

NKK Switches can provide custom legends for caps. Contact factory for more information.

Suggested Printable Area for Cap

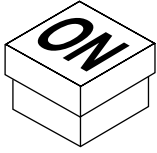

Recommended Print Method:

Screen Print or Pad Print

Epoxy based ink is recommended.

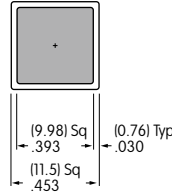

AT465

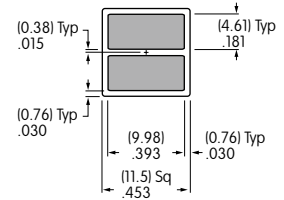

AT465

Shaded areas are printable areas.



Компания «ЭлектроПласт» предлагает заключение долгосрочных отношений при поставках импортных электронных компонентов на взаимовыгодных условиях!

Наши преимущества:

- Оперативные поставки широкого спектра электронных компонентов отечественного и импортного производства напрямую от производителей и с крупнейших мировых складов;
- Поставка более 17-ти миллионов наименований электронных компонентов;
- Поставка сложных, дефицитных, либо снятых с производства позиций;
- Оперативные сроки поставки под заказ (от 5 рабочих дней);
- Экспресс доставка в любую точку России;
- Техническая поддержка проекта, помощь в подборе аналогов, поставка прототипов;
- Система менеджмента качества сертифицирована по Международному стандарту ISO 9001;
- Лицензия ФСБ на осуществление работ с использованием сведений, составляющих государственную тайну;
- Поставка специализированных компонентов (Xilinx, Altera, Analog Devices, Intersil, Interpoint, Microsemi, Aeroflex, Peregrine, Syfer, Eurofarad, Texas Instrument, Miteq, Cobham, E2V, MA-COM, Hittite, Mini-Circuits, General Dynamics и др.);

Помимо этого, одним из направлений компании «ЭлектроПласт» является направление «Источники питания». Мы предлагаем Вам помощь Конструкторского отдела:

- Подбор оптимального решения, техническое обоснование при выборе компонента;
- Подбор аналогов;
- Консультации по применению компонента;
- Поставка образцов и прототипов;
- Техническая поддержка проекта;
- Защита от снятия компонента с производства.



Как с нами связаться

Телефон: 8 (812) 309 58 32 (многоканальный)

Факс: 8 (812) 320-02-42

Электронная почта: org@eplast1.ru

Адрес: 198099, г. Санкт-Петербург, ул. Калинина, дом 2, корпус 4, литера А.