

PNP PRE-BIASED SMALL SIGNAL SOT23 SURFACE MOUNT TRANSISTOR
Features

- Epitaxial Planar Die Construction
- Complementary NPN Types Available (DDTC)
- Built-In Biasing Resistors, R1 = R2
- "Lead Free", RoHS Compliant (Note 1)
- Halogen and Antimony Free "Green" Device (Note 2)
- Qualified to AEC-Q101 Standards for High Reliability

Mechanical Data

- Case: SOT23
- Case material: Molded Plastic. "Green" Molding Compound.
- Classification Rating 94V-0
- Moisture Sensitivity: Level 1 per J-STD-020
- Terminals: Matte Tin Finish
- Weight: 0.008 grams (approximate)

Part Number	R1, R2 (NOM)
DDTA123ECA	2.2KΩ
DDTA143ECA	4.7KΩ
DDTA114ECA	10KΩ
DDTA124ECA	22KΩ
DDTA144ECA	47KΩ
DDTA115ECA	100KΩ



Top View

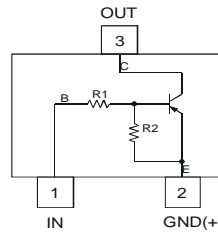

Device Schematic

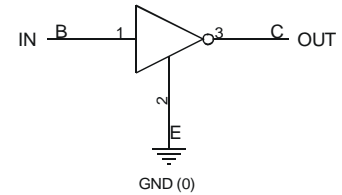

Equivalent Inverter Circuit

Ordering Information (Note 3 & 4)

Product	Grade	Marking	Reel size (inches)	Tape width (mm)	Quantity per reel
DDTA123ECA-7-F	Commercial	P04	7	8	3,000
DDTA143ECA-7-F	Commercial	P08	7	8	3,000
DDTA114ECA-7-F	Commercial	P13	7	8	3,000
DDTA114ECAQ-7-F	Automotive	P13	7	8	3,000
DDTA114ECAQ-13-F	Automotive	P13	13	8	10,000
DDTA124ECA-7-F	Commercial	P17	7	8	3,000
DDTA144ECA-7-F	Commercial	P20	7	8	3,000
DDTA115ECA-7-F	Commercial	P24	7	8	3,000

- Notes:
1. No purposefully added lead.
 2. Diodes Inc's "Green" policy can be found on our website at <http://www.diodes.com>.
 3. For packaging details, go to our website at <http://www.diodes.com>.
 4. Products with Q-suffix are automotive grade. Automotive products are electrical and thermal the same as the commercial, except where specified.

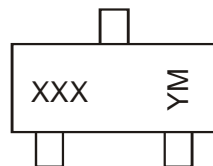
Marking Information

XXX = Product Type Marking Code, See Ordering Information
 YM = Date Code Marking
 Y = Year (ex: X = 2010)
 M = Month (ex: 9 = September)

Date Code Key

Year	2002	2003	2004	2005	2006	2007	2008	2009	2010	2011	2012	2013	2014	2015	2016	2017
Code	N	P	R	S	T	U	V	W	X	Y	Z	A	B	C	D	E

Month	Jan	Feb	Mar	Apr	May	Jun	Jul	Aug	Sep	Oct	Nov	Dec
Code	1	2	3	4	5	6	7	8	9	O	N	D

Maximum Ratings @ $T_A = 25^\circ\text{C}$ unless otherwise specified

Characteristic		Symbol	Value	Unit
Supply Voltage <Pin: (3) to (2)>		V_{CC}	50	V
Input Voltage <Pin: (1) to (2)>	DDTA123ECA	V_{IN}	+10 to -12	V
	DDTA143ECA		+10 to -30	
	DDTA114ECA		+10 to -40	
	DDTA124ECA		+10 to -40	
	DDTA144ECA		+10 to -40	
	DDTA115ECA		+10 to -40	
Output Current	DDTA123ECA	I_O	-100	mA
	DDTA143ECA		-100	
	DDTA114ECA		-50	
	DDTA124ECA		-30	
	DDTA144ECA		-30	
	DDTA115ECA		-20	
Output Current		I_C (Max)	-100	mA

Thermal Characteristics @ $T_A = 25^\circ\text{C}$ unless otherwise specified

Characteristic	Symbol	Value	Unit
Power Dissipation (Note 5 & 6)	P_D	200	mW
Thermal Resistance, Junction to Ambient Air (Note 5)	$R_{\theta JA}$	625	$^\circ\text{C}/\text{W}$
Operating and Storage Temperature Range	T_J, T_{STG}	-55 to +150	$^\circ\text{C}$

Notes: 5. Mounted on FR4 PC Board with minimum recommended pad layout
6. 150mW per element must not be exceeded.

Electrical Characteristics @T_A = 25°C unless otherwise specified

Characteristic		Symbol	Min	Typ	Max	Unit	Test Condition
Input Voltage		V _{I(off)}	-0.5	-1.1	—	V	V _{CC} = -5V, I _O = -100μA
		V _{I(on)}	—	-1.9	-3		V _O = -0.3V, I _O = -20mA, DDTA123ECA V _O = -0.3V, I _O = -20mA, DDTA143ECA V _O = -0.3V, I _O = -10mA, DDTA114ECA V _O = -0.3V, I _O = -5mA, DDTA124ECA V _O = -0.3V, I _O = -2mA, DDTA144ECA V _O = -0.3V, I _O = -1mA, DDTA115ECA
Output Voltage		V _{O(on)}	—	-0.1	-0.3	V	I _O /I _I = -10mA/-0.5mA DDTA123ECA I _O /I _I = -10mA/-0.5mA DDTA143ECA I _O /I _I = -10mA/-0.5mA DDTA114ECA I _O /I _I = -10mA/-0.5mA DDTA124ECA I _O /I _I = -10mA/-0.5mA DDTA144ECA I _O /I _I = -5mA/-0.25mA DDTA115ECA
Input Current	DDTA123ECA DDTA143ECA DDTA114ECA DDTA124ECA DDTA144ECA DDTA115ECA	I _I	—	—	-3.8 -1.8 -0.88 -0.36 -0.18 -0.15	mA	V _I = -5V
Output Current		I _{O(off)}	—	—	-0.5	μA	V _{CC} = -50V, V _I = 0V
DC Current Gain	DDTA123ECA DDTA143ECA DDTA114ECA DDTA124ECA DDTA144ECA DDTA115ECA	G _I	20 20 30 56 68 82	—	—	—	V _O = -5V, I _O = -20mA V _O = -5V, I _O = -10mA V _O = -5V, I _O = -5mA V _O = -5V, I _O = -5mA V _O = -5V, I _O = -5mA V _O = -5V, I _O = -5mA
Input Resistor Tolerance		ΔR ₁	-30	—	+30	%	—
Resistance Ratio Tolerance		ΔR ₂ /R ₁	0.8	1	1.2	%	—
Gain-Bandwidth Product		f _T	—	250	—	MHz	V _{CE} = -10V, I _E = -5mA, f = 100MHz

Typical Characteristics – DDTA143ECA

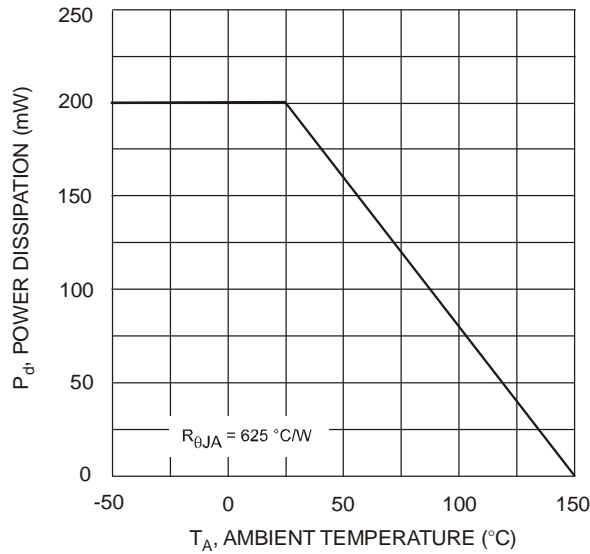

Fig. 1 Derating Curve

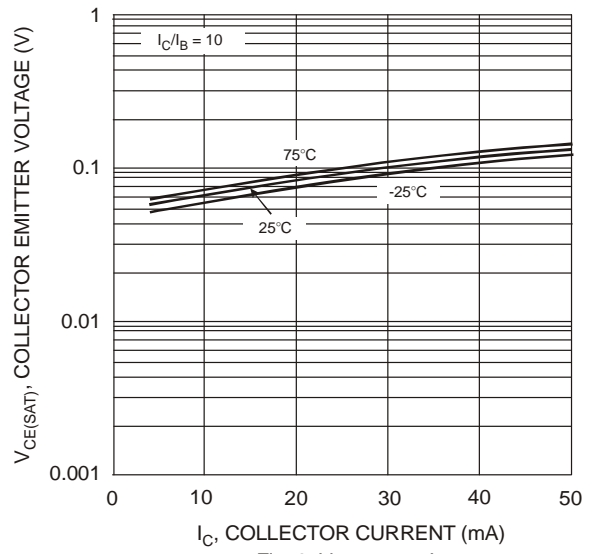

Fig. 2 $V_{CE(SAT)}$ vs. I_C

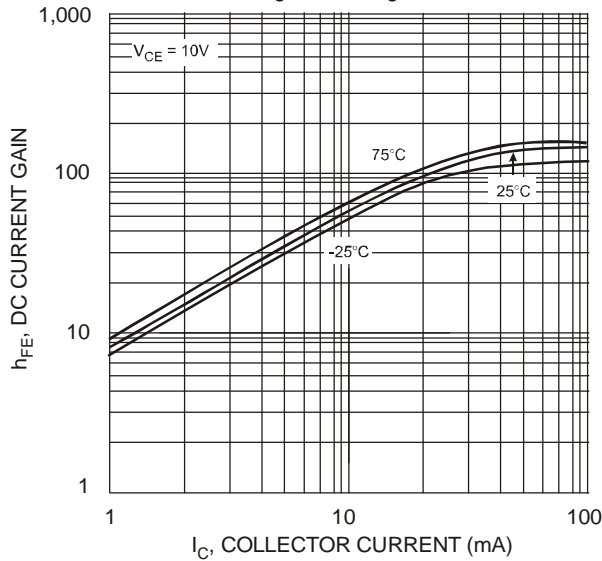

Fig. 3 DC Current Gain

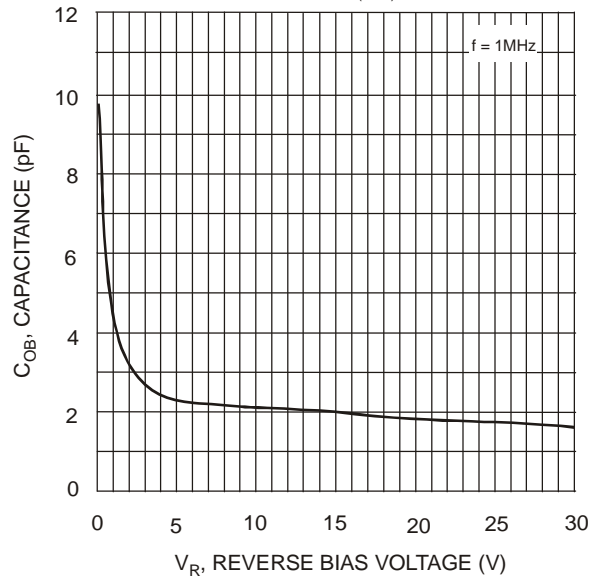

Fig. 4 Output Capacitance

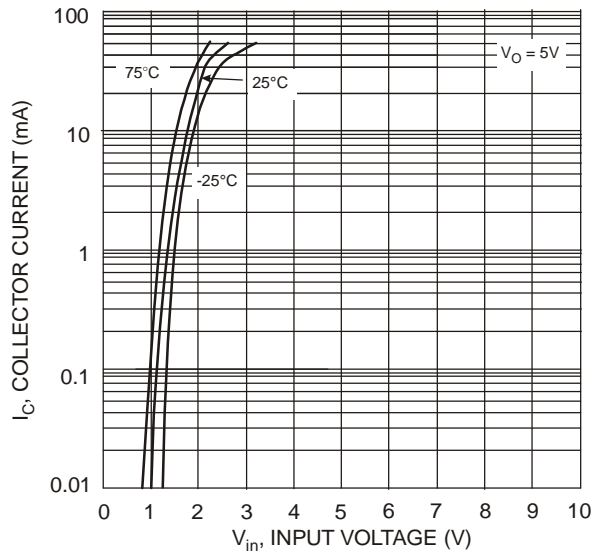

Fig. 5 Collector Current vs. Input Voltage

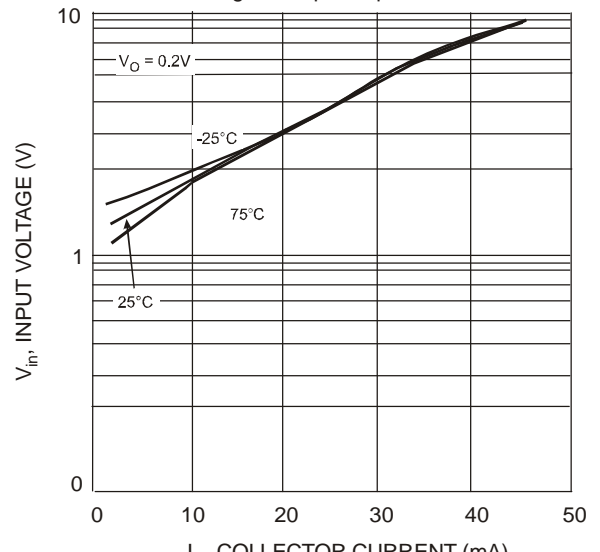
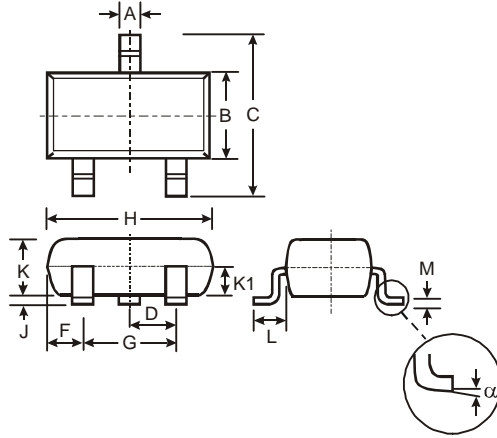

Fig. 6 Input Voltage vs. Collector Current

Package Outline Dimensions



SOT23			
Dim	Min	Max	Typ
A	0.37	0.51	0.40
B	1.20	1.40	1.30
C	2.30	2.50	2.40
D	0.89	1.03	0.915
F	0.45	0.60	0.535
G	1.78	2.05	1.83
H	2.80	3.00	2.90
J	0.013	0.10	0.05
K	0.903	1.10	1.00
K1	-	-	0.400
L	0.45	0.61	0.55
M	0.085	0.18	0.11
α	0°	8°	-
All Dimensions in mm			

Suggested Pad Layout

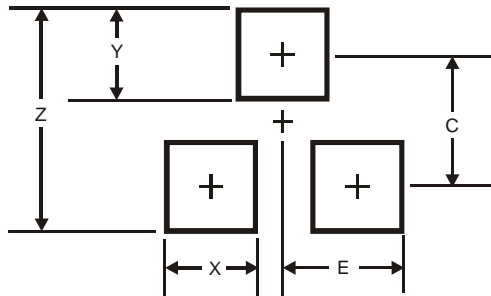

Dimensions	Value (in mm)
Z	2.9
X	0.8
Y	0.9
C	2.0
E	1.35

IMPORTANT NOTICE

DIODES INCORPORATED MAKES NO WARRANTY OF ANY KIND, EXPRESS OR IMPLIED, WITH REGARDS TO THIS DOCUMENT, INCLUDING, BUT NOT LIMITED TO, THE IMPLIED WARRANTIES OF MERCHANTABILITY AND FITNESS FOR A PARTICULAR PURPOSE (AND THEIR EQUIVALENTS UNDER THE LAWS OF ANY JURISDICTION).

Diodes Incorporated and its subsidiaries reserve the right to make modifications, enhancements, improvements, corrections or other changes without further notice to this document and any product described herein. Diodes Incorporated does not assume any liability arising out of the application or use of this document or any product described herein; neither does Diodes Incorporated convey any license under its patent or trademark rights, nor the rights of others. Any Customer or user of this document or products described herein in such applications shall assume all risks of such use and will agree to hold Diodes Incorporated and all the companies whose products are represented on Diodes Incorporated website, harmless against all damages.

Diodes Incorporated does not warrant or accept any liability whatsoever in respect of any products purchased through unauthorized sales channel. Should Customers purchase or use Diodes Incorporated products for any unintended or unauthorized application, Customers shall indemnify and hold Diodes Incorporated and its representatives harmless against all claims, damages, expenses, and attorney fees arising out of, directly or indirectly, any claim of personal injury or death associated with such unintended or unauthorized application.

Products described herein may be covered by one or more United States, international or foreign patents pending. Product names and markings noted herein may also be covered by one or more United States, international or foreign trademarks.

LIFE SUPPORT

Diodes Incorporated products are specifically not authorized for use as critical components in life support devices or systems without the express written approval of the Chief Executive Officer of Diodes Incorporated. As used herein:

A. Life support devices or systems are devices or systems which:

1. are intended to implant into the body, or
2. support or sustain life and whose failure to perform when properly used in accordance with instructions for use provided in the labeling can be reasonably expected to result in significant injury to the user.

B. A critical component is any component in a life support device or system whose failure to perform can be reasonably expected to cause the failure of the life support device or to affect its safety or effectiveness.

Customers represent that they have all necessary expertise in the safety and regulatory ramifications of their life support devices or systems, and acknowledge and agree that they are solely responsible for all legal, regulatory and safety-related requirements concerning their products and any use of Diodes Incorporated products in such safety-critical, life support devices or systems, notwithstanding any devices- or systems-related information or support that may be provided by Diodes Incorporated. Further, Customers must fully indemnify Diodes Incorporated and its representatives against any damages arising out of the use of Diodes Incorporated products in such safety-critical, life support devices or systems.

Copyright © 2011, Diodes Incorporated

www.diodes.com



Компания «ЭлектроПласт» предлагает заключение долгосрочных отношений при поставках импортных электронных компонентов на взаимовыгодных условиях!

Наши преимущества:

- Оперативные поставки широкого спектра электронных компонентов отечественного и импортного производства напрямую от производителей и с крупнейших мировых складов;
- Поставка более 17-ти миллионов наименований электронных компонентов;
- Поставка сложных, дефицитных, либо снятых с производства позиций;
- Оперативные сроки поставки под заказ (от 5 рабочих дней);
- Экспресс доставка в любую точку России;
- Техническая поддержка проекта, помощь в подборе аналогов, поставка прототипов;
- Система менеджмента качества сертифицирована по Международному стандарту ISO 9001;
- Лицензия ФСБ на осуществление работ с использованием сведений, составляющих государственную тайну;
- Поставка специализированных компонентов (Xilinx, Altera, Analog Devices, Intersil, Interpoint, Microsemi, Aeroflex, Peregrine, Syfer, Eurofarad, Texas Instrument, Miteq, Cobham, E2V, MA-COM, Hittite, Mini-Circuits, General Dynamics и др.);

Помимо этого, одним из направлений компании «ЭлектроПласт» является направление «Источники питания». Мы предлагаем Вам помощь Конструкторского отдела:

- Подбор оптимального решения, техническое обоснование при выборе компонента;
- Подбор аналогов;
- Консультации по применению компонента;
- Поставка образцов и прототипов;
- Техническая поддержка проекта;
- Защита от снятия компонента с производства.



Как с нами связаться

Телефон: 8 (812) 309 58 32 (многоканальный)

Факс: 8 (812) 320-02-42

Электронная почта: org@eplast1.ru

Адрес: 198099, г. Санкт-Петербург, ул. Калинина, дом 2, корпус 4, литера А.