

## Code Reader/OCR

Tracing Products Group Catalog

▶▶ High-accuracy, Multifunctional Readers



LOT. NO. S4153 2013

12 packs 2013.01.15



▶▶ Ultra-compact, High-speed Readers



# Code Reader

You can select the optimum products from  
We provide Readers for everything from Bar Codes and 2D Codes  
The lineup also includes Readers that

## Ultra Compact and Fast

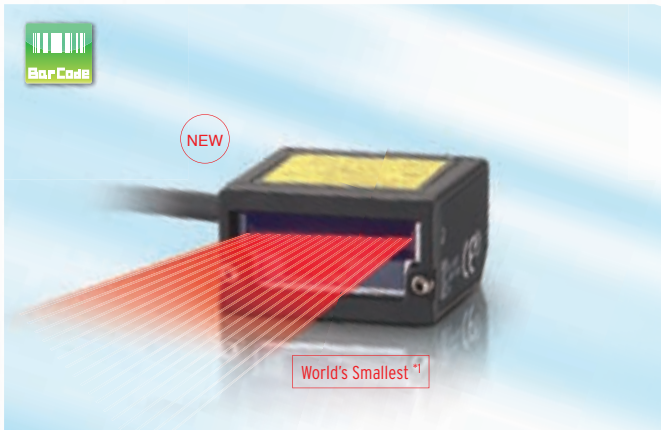

### Laser-type Bar Code Reader

#### V500-R2 Series

- High speed: 1,000 scans/s
- Long distance: 270 mm
- World's Smallest



### Multi Code Reader

#### V400-R2 Series

- Fastest reading in the class:  
Reads moving objects at up to 500 m/min \*2
- Long distance: 125 mm
- Ultra compact

▶▶ P4



### Conveyors

- Ultra compact for possible mounting in rail gaps.
- Stable reading of high-speed moving objects.

▶▶ P8



### Semiconductor Manufacturing Equipment

- World's smallest reader handles 300-mm wafer loading ports.



### Cartoners

- Prevention of mixing of different cartons by reading bar codes.



### Labeler

- Reading to check printing conditions.

\*1.According to OMRON investigation in January 2013.

\*2.Performance may depend on the code that is read and the printing conditions.

# and OCR Lineup

OMRON's wide lineup of tracing products.  
 printed on paper or labels to DPM directly printed on workpieces.  
 can read expiration dates and other text.

## High-accuracy and Multifunctional



**Multi Code Reader**  
FQ-CR1 Series

- HDR function to cut out ambient light interference.
- Polarizing filter to cut specular reflections.
- Verification with master data.

▶▶ P 12



**2D Code Reader for DPM**  
FQ-CR2 Series

- Reads direct part marking codes.
- Cuts halation from metallic surfaces.
- High-power LED that is effective for low contrast.

▶▶ P 12



**Optical Character Recognition Sensor**  
FQ2-CH Series

- New OCR algorithm.
- Easy application with no dictionary registration.
- Handles dot characters, stamped characters, and more.

▶▶ P 16



**Smart Camera**  
FQ2-S4 Series

- Code reader, OCR, and inspections.
- Lineup includes Integrated Sensors and C-mounts.
- High resolution of 760,000 or 1,300,000 pixels.

▶▶ P 20



### Case Packers

- Lineup of models with many installation distances from 38 to 970 mm.
- Stable reading of low-contrast codes.



### Automotive Processing Machines

- High-performance filters that cut specular reflections from metallic or glossy surfaces.



### Cartoners

- Multi-processing of everything needed for cartoners: character verification, code reading, and inspections.

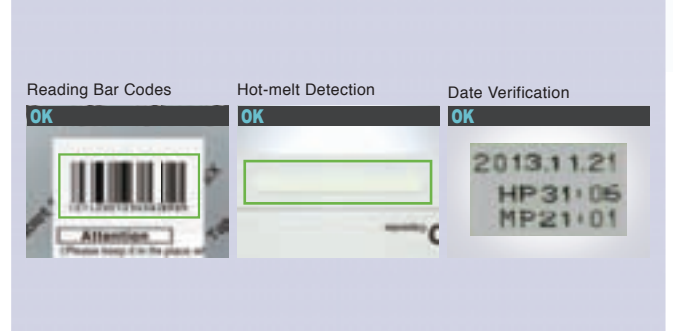
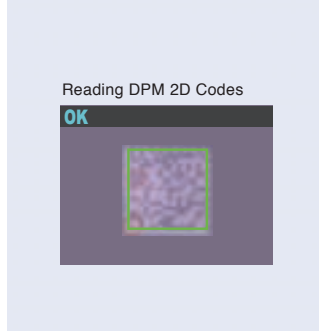
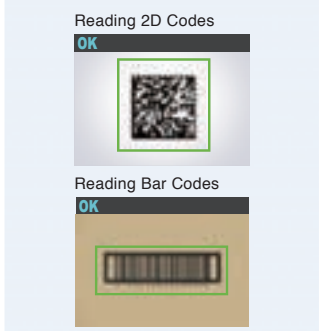



# The World's Smallest\* Bar Code Reader That Fits Essentially Anywhere

\*According to OMRON investigation in January 2013.

## Laser-type Bar Code Reader V500-R2 Series

NEW



## High-speed Reading at 1,000 Scans/Second

A high-speed motor and new algorithm gives surprising performance for the size to achieve stable reading even in high-speed takt machines of around 66,000 items/hour.

## Enables Reading Imperfect Codes

Even though it is small, the V500-R2 with its new algorithm is adept at reading even the most imperfect codes. Raster scanning enables reading Bar Codes even if they are partially dirty or missing.

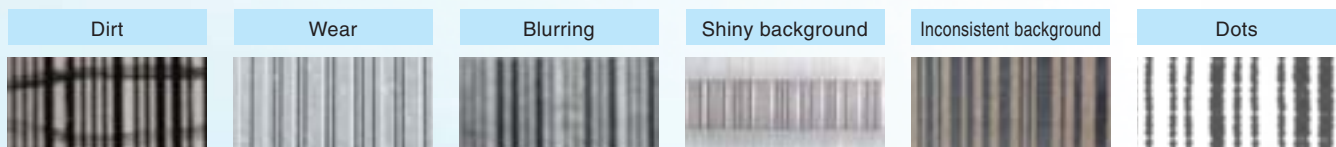

## Resists Ambient Light Interference

Operation is possible with ambient illumination of up to 80,000 lx (sunlight), so the Code Reader can stably read even near Photoelectric Sensors with little influence from ambient light.

Ambient Light Interference Guidelines	
Florescent light	4,000 lx max.
Sunlight	80,000 lx max.



## Long Range Up to 270 mm

The wide reading distance from 60 to 270 mm lets you handle variations in conveying and workpiece height without changing the installation.

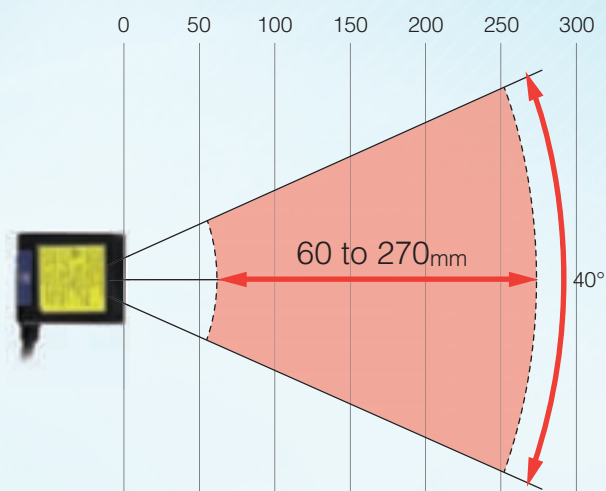

## Reading Test Switch Provided

Just press the Scan button on the Reader to perform a read test. The results are provided with the Read OK indicator and buzzer. We achieved an operation that is simple enough for essentially anyone to increase mounting efficiency.

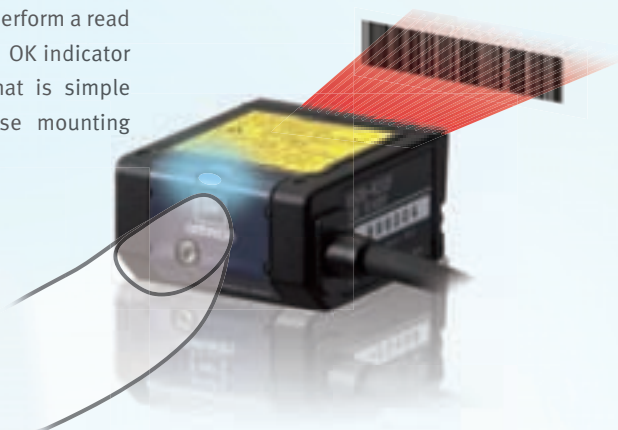

## Minimum Readable Narrow Bar Width: 0.15 mm

Reading is even possible for Bar Codes with narrow bars of 0.15 mm.

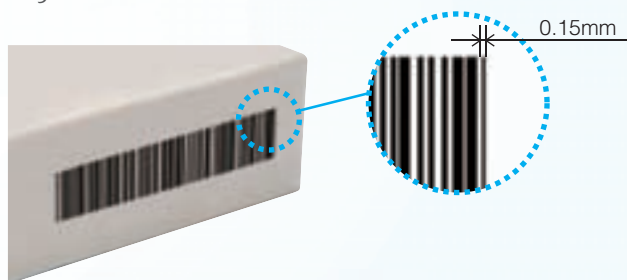

## GS1-Databar (RSS) Supported

The data-rich GS1-Databar (RSS code) Bar Codes can also be read.



## Verification with Master Data

You can verify character strings to see if they match preset master data without a special device.

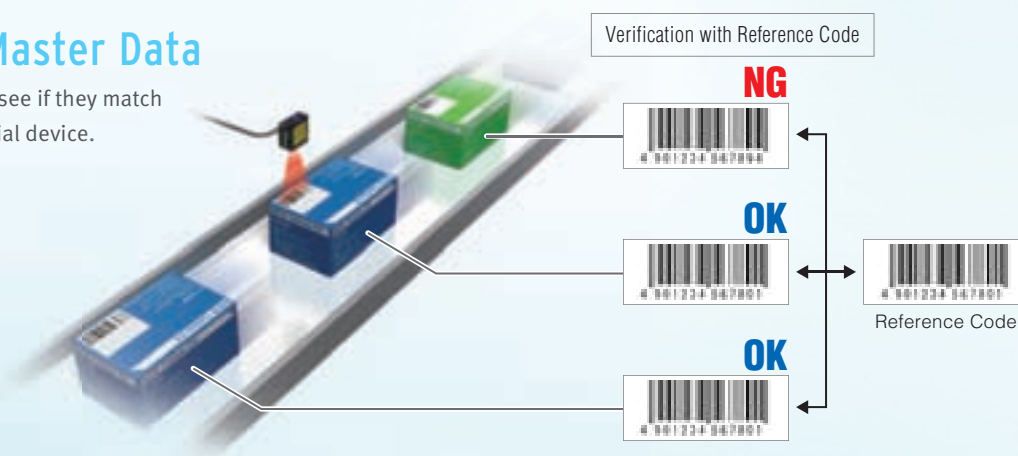

## Ordering Information

Type		Model
Laser-type Bar Code Reader		V500-R2CF
OMRON PLC connecting cable	D-sub 9-pin, 0.8M	V509-W011
	D-sub 9-pin, 5M	V509-W016
PC/AT Connecting cable	D-sub 9-pin, 0.8M	V509-W011D
	D-sub 9-pin, 5M	V509-W016D

## Ratings and Performance

Model		V500-R2CF
Direction of view		Front view
Applicable codes	Bar code	WPC(JAN/EAN/UPC), Codabar(NW-7), ITF, Industrial 2 of 5(STF), Code39, Code93, Code128, GS1-128(EAN-128), GS1-Databar(RSS-14), GS1-Databar Limited(RSS Limited), GS1-Databar Expanded(RSSExpanded)
	Number of reading digits	No upper limit (depends on bar width and reading distance)
Reading performance(*)	Minimum resolution	Bar code: 0.15 mm
	Contrast (PCS)	0.45 or more (white reflectance 70 % or more)
	Reading distance	60 to 270 mm (At narrow bar: 0.5 mm)
	Reading angle	Within 40° (Including margins at left and right sides)
	Pitch angle ( $\alpha$ )	$\pm 30^\circ$
	Skew angle ( $\beta$ )	$\pm 60^\circ$ (However, exclude from 10° upper side to 8° lower side)
	Tilt angle ( $\gamma$ )	$\pm 25^\circ$
	Reading of bar codes on curved surfaces (R)	$R \geq 20\text{mm}$ (UPC 12 digit)
	Light source	Red laser diode (Wave length: 650 nm)
	Light output	1.0m W or less (Correspond to JIS class 2)
Interface	Scan type	Raster scan
	Number of scan	1000 scan/sec.
	Communication specification	RS-232C
Interface	OK/NG outputs	NPN open collector output (cable work required)
	Function setting method	Menu sheet reading method or host command method
Functional specifications	Reading trigger	External trigger (Transistor input), Trigger by command (RS-232C), Trigger a test reading by pressing the SCAN button on the product
	OK/NG signals	OK signal is turned on to indicate a successful read NG signal is turned on to indicate a successful read of a non-registered label
	Indication LED	OK LED (green) illuminates to indicate a successful read
	Buzzer	Notifies a successful reading with a buzzer sound (Muting available)
Power supply specification	Power voltage	4.5 to 5.5 VDC
	Consumption current	During operation: 500 mA or less; during standby: 150 mA or less
	Inrush current	2.0 A MAX
Environmental specifications	Ambient temperature range	At operation: 0 to + 45°C At storage: -20 to + 60°C
	Ambient humidity range	At operation and storage: 20 to 85% RH (with no icing or condensation)
	Ambient atmosphere	No corrosive gases
	Ambient light	Fluorescent lamp: 4,000lx or less, Sunlight: 80,000lx or less
	Vibration resistance	10 to 150 Hz, half amplitude 0.35 mm, 3 directions (X/Y/Z), 8 minutes each 10 times
Degree of protection		IP54 (IEC60529)
Weight	Main unit only	Approximately 80 g
	Including accessories	Approximately 190 g (including mounting bracket, insulation plate and screws)
	Packaged weight	Approximately 270 g (including packing carton)
Dimensions	Main unit	Approximately 29(W) × 34.5(D) × 17(H)mm
	Packing carton	Approximately 245(W) × 110(D) × 40(H)mm
Input/output connector		Round DIN connector
Code length		Approximately 1.5 m
Minimum bending radius of cord		Approximately 23 mm
Accessories		Operation manual, menu sheet, mounting bracket, insulation plate, M3 × 6 screw (two), M3 × 8 screws (one), M5 × 10 screws (two)
Material, Color	Upper case	Magnesium diecast, black
	Front panel	PC, black
	Labels	PET
	Reading window	PMMA, transparent
	Cable	Polyvinyl chloride (PVC), black
	Insulation plate	ABS, black
	Mounting bracket	SUS304, silver

\* Unless otherwise specified, use a JAN x1, MRD 63% or higher (PCS = 0.9 or higher) bar code with a pitch angle  $\alpha = 0^\circ$ , a skew angle  $\beta = 15^\circ$ , a tilt angle  $\gamma = 0^\circ$ , and a curvature  $R = \infty$ .

## Reading range performance (typical example)

Explained with examples of following conditions:

- Contrast: MRD 63 % (PCS = 0.9)
- Bar code: CODE39
- Installation condition:  
Pitch angle  $\alpha = 0^\circ$ , skew angle  $\beta = 15^\circ$   
Tilt angle  $\gamma = 0^\circ$ , curvature  $R = \infty$

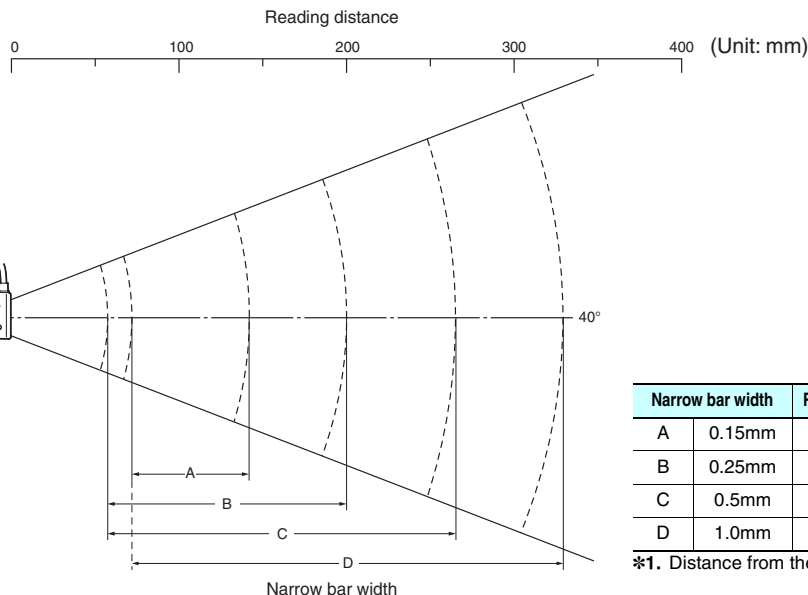
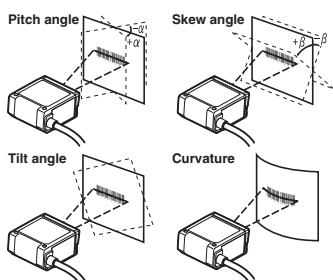

Narrow bar width	Reading distance (*1)	
A	0.15mm	70 to 140mm
B	0.25mm	60 to 200mm
C	0.5mm	60 to 270mm
D	1.0mm	70 to 330mm

\*1. Distance from the end of the case.

## Dimensions

(Unit: mm)

### Bar Code Reader V500-R2CF

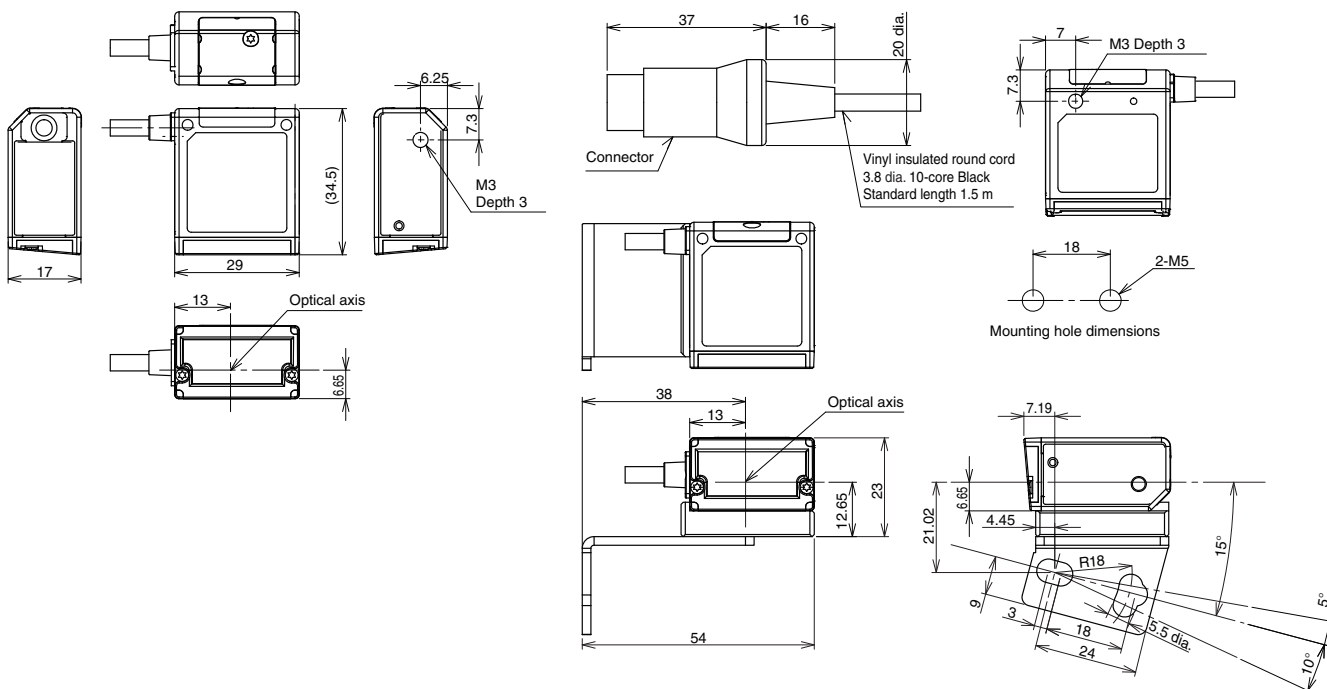

### Safety Precautions for Laser Equipment



**WARNING**

Avoid eye exposure to direct or scattered radiation reflected by a mirror surface.  
Laser beam emitted from a laser has high power density and may become blind when the beam is directed into eyes.



### Laser Label Indications

This warning label is attached to the Bar Code Reader.  
Never remove this label or place objects in front of it.



## Related Manuals

Man.No.	Model number	Manual
Z334	V500-R2	Laser-Type Bar Code Reader V500-R2 Series User's Manual

## Multi Code Reader



# The Ultra-small Multi-code Reader That Can Handle Speed

## Multi Code Reader V400-R2 Series

**NEW**



## Improves Machine Takt Time with the Fastest Reading in the Class: Reads Moving Objects at Up to 500 m/min\*

It is not just the size that makes this Reader easy to build into equipment. It enables stable reading of moving objects on high-speed lines. Build it into equipment to read moving objects, which is achieved with a new algorithm.

\* Performance may depend on the code that is read and the printing conditions.



## Stable Reading of Imperfect Codes

The V400-R2 with its new algorithm is adept even the most imperfect codes. Even for codes that were previously difficult to read, you can change the exposure time and gain to achieve the optimum settings to enable reading.

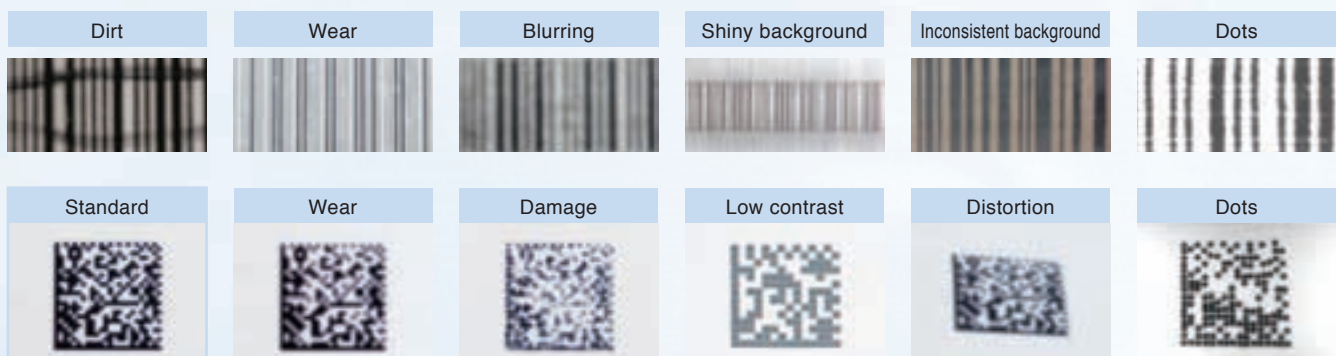



## Distance Variations

There are two models in the lineup to let you select the field of view or installation distance that is best for the equipment type. Both models are the same size, so additional design work is not necessary to change the model.

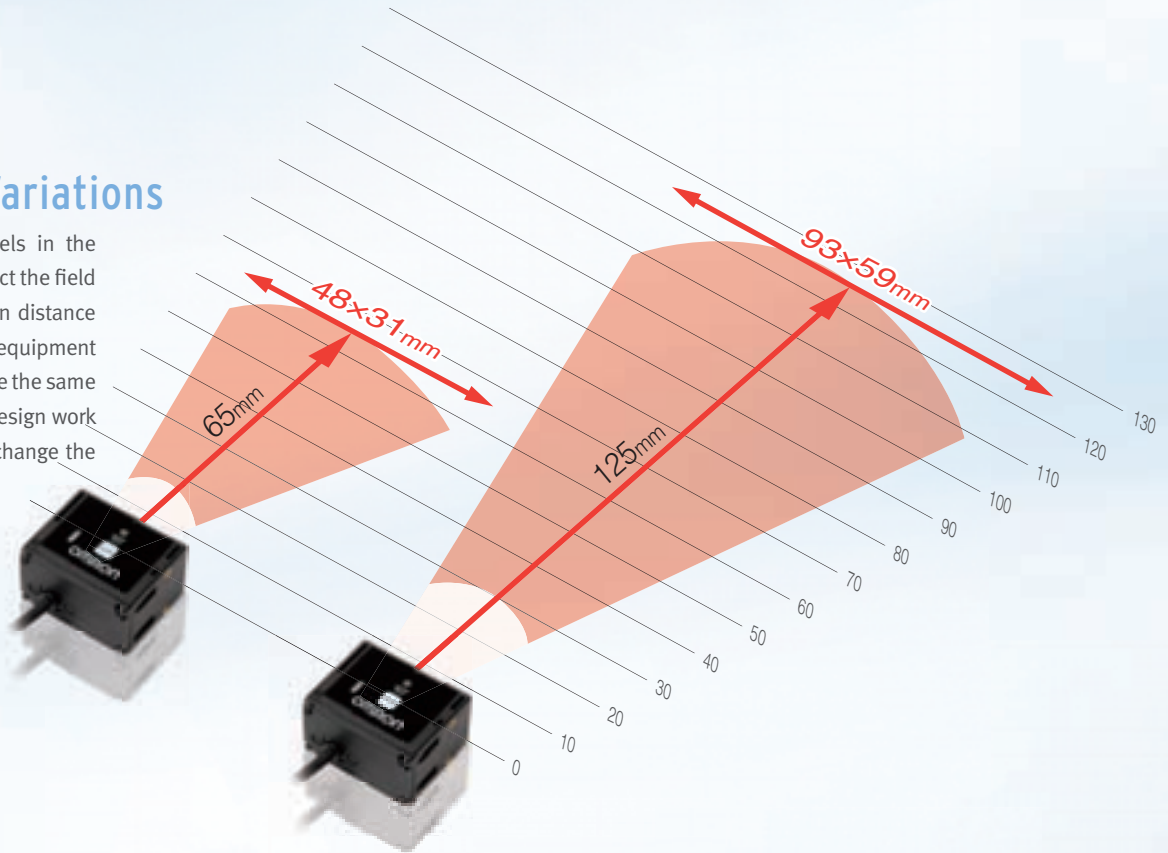

## Reading Test Switch Provided

We achieved an operation that is simple enough for essentially anyone. Just press the Scan button on the Reader to perform a read test. The results are provided with the Read OK indicator and buzzer.



## Aiming Positioning Function

A guide light lets you easily find the ideal installation position. You can easily and quickly position the codes with the aiming function.

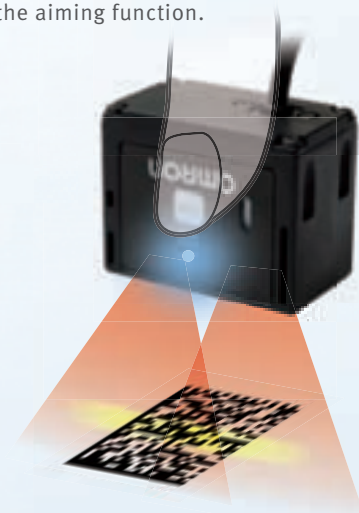

## Body Resists Environments to IP65

IP65 protection is provided because that is generally the level that is required to build devices into equipment. That enables reliable application in harsh environments subject to water and mist.

## GS1-Databar (RSS) Supported

The data-rich GS1-Databar (RSS code) Bar Codes can also be read. This enables reliable applications in the pharmaceutical industry, where GS1-Databar (RSS code) Bar Codes are becoming popular.

## Verification with Master Data

You can verify character strings to see if they match preset master data without a special device.



## Ordering Information

Type	Model	
Multi Code Reader	Working distance 65mm	V400-R2CF65
	Working distance 125mm	V400-R2CF125
OMRON PLC connecting cable	D-sub 9-pin, 0.8M	V509-W011
	D-sub 9-pin, 5M	V509-W016
PC/AT Connecting cable	D-sub 9-pin, 0.8M	V509-W011D
	D-sub 9-pin, 5M	V509-W016D

## Ratings and Performance

Model	V400-R2CF65	V400-R2CF125	
<b>Direction of view</b>	Front view		
<b>Applicable codes</b>	<b>Bar code</b>	WPC(JAN/EAN/UPC), Codabar(NW-7), ITF, Industrial 2 of 5, Code39, Code93, Code128, GS1-128(EAN-128), GS1-Databar(RSS-14), GS1-Databar Limited(RSS Limited), GS1-Databar Expanded (RSS Expanded), GS1-Databar Composite(RSS Composite)	
	<b>2D code</b>	QR code, DataMatrix(ECC200), MicroQR code, PDF417, MicroPDF417, AztecCode, MaxiCode, Codablock-F	
<b>Reading performance (*)</b>	<b>Number of reading digits</b>	No upper limit (depends on bar width and reading distance)	
	<b>Light source</b>	Two red LEDs (wave length: 617 nm)	
	<b>Aiming light</b>	One green LED (wave length: 528 nm)	
	<b>Minimum resolution</b>	Bar code: 0.076 mm 2D code: 0.169 mm	Bar code: 0.127 mm 2D code: 0.212 mm
	<b>Image capture device</b>	Monochrome CMOS	
	<b>Effective number of pixels</b>	754 × 480 pixels	
	<b>Working distance (WD)</b>	65mm	125mm
	<b>Field of view</b>	Approximately 48 × 31(for WD = 65 mm)	Approximately 93 × 59(for WD = 125 mm)
	<b>Pitch angle (<math>\alpha</math>)</b>	±50°	
	<b>Skew angle (<math>\beta</math>)</b>	±50°	
	<b>Tilt angle (<math>\gamma</math>)</b>	±180°	
<b>Reading of bar codes on curved surfaces (R)</b>	R ≥ 20mm (UPC 12 line)		
<b>Interface</b>	<b>Communication specification</b>	RS-232C	
	<b>OK/NG outputs</b>	NPN open collector output (cable work required)	
<b>Function setting method</b>	Menu sheet reading method or host command method		
<b>Functional specifications</b>	<b>Reading trigger</b>	External trigger (Transistor input) Trigger by command (RS-232C) Trigger a test reading by pressing the SCAN button on the product	
	<b>OK/NG signals</b>	OK signal is turned on to indicate a successful read OK signal is turned on to indicate a successful read of registered label NG signal is turned on to indicate a successful read of a non-registered label	
	<b>Indication LED</b>	OK LED (green) illuminates to indicate a successful read	
	<b>Buzzer</b>	Notifies a successful reading with a buzzer sound (Muting available)	
<b>Power supply specification</b>	<b>Power voltage</b>	4.5 to 5.5 VDC	
	<b>Consumption current</b>	During operation: 265 mA or less; during standby: 70 mA or less	
<b>Environmental specifications</b>	<b>Ambient temperature range</b>	At operation: 0 to + 45°C; At storage: -10 to + 60°C	
	<b>Ambient humidity range</b>	At operation and storage: 20 to 85% RH (with no icing or condensation)	
	<b>Ambient atmosphere</b>	No corrosive gases	
	<b>Ambient light</b>	Fluorescent lamp: 10,000lx or less, Sunlight: 100,000lx or less	
	<b>Vibration resistance</b>	10 to 150 Hz, half amplitude 0.35 mm, 3 directions (X/Y/Z), 8 minutes each 10 times	
<b>Degree of protection</b>	IP54 (IEC60529)		
<b>Weight</b>	<b>Main unit only</b>	Approximately 90 g	
	<b>Including accessories</b>	Approximately 200 g (including mounting bracket and screws)	
	<b>Packaged weight</b>	Approximately 280 g (including packing carton)	
<b>Dimensions</b>	<b>Main unit</b>	Approximately 41(W) × 33(D) × 24(H) mm	
	<b>Packing carton</b>	Approximately 240(W) × 110(D) × 40(H) mm	
<b>Input/output connector</b>	Round DIN connector		
<b>Code length</b>	Approximately 1.5 m		
<b>Minimum bending radius of cord</b>	Approximately 23 mm		
<b>Accessories</b>	Operation manual, menu sheet, mounting bracket, M2 × 6 screws (two), M5 × 10 screws (two)		
<b>Material, Color</b>	<b>Case</b>	PC, PET, black	
	<b>Reading window</b>	PMMA, transparent	
	<b>Cable</b>	Polyvinyl chloride (PVC), black	
	<b>Mounting bracket</b>	SUS304, silver	

\* Unless otherwise specified, the reading performance is defined with angle  $\alpha = 0^\circ$ ,  $\beta = +15^\circ$ ,  $\gamma = 0^\circ$ ,  $R = \infty$ ; illuminance: 100 to 2001x, reading rate: 90% or more.

•QR code is the registered trademark of DENSO WAVE.

# Reading range performance (typical example)

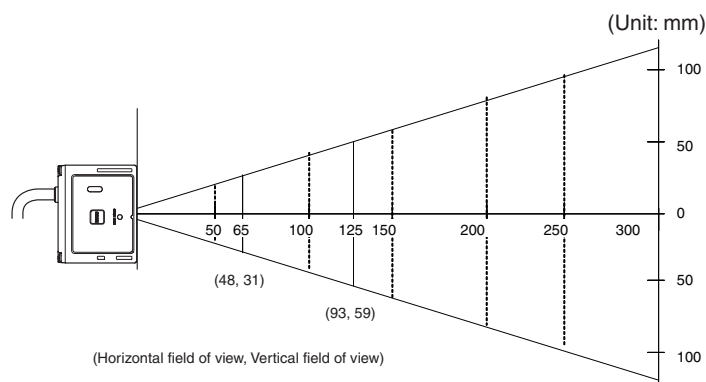

- Explained with examples of following conditions:
- Contrast: MRD 63% (PCS = 0.9)
  - Installation condition: Pitch angle  $\alpha = 0^\circ$ , skew angle  $\beta = 15^\circ$ , Tilt angle  $\gamma = 0^\circ$ , curvature  $R = \infty$
  - Reading rate: 90% or more in 10 tries

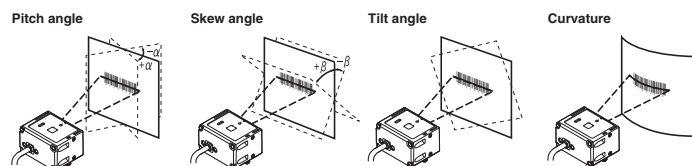

## V400-R2CF125 2D code (typical example)

Code types	Resolution	Reading distance	Field-of-view size at reading distance
QR Code	0.212	90 to 115	67×42 to 85×54
	0.381	55 to 195	41×26 to 144×91
Data Matrix	0.254	75 to 145	55×33 to 107×68
PDF417	0.169	80 to 140	59×38 to 104×66
	0.254	60 to 195	44×28 to 144×91

## Bar code (typical example)

Code types	Resolution	Reading distance	Field-of-view size at reading distance
Code39	0.127	85 to 125	63×47 to 92×59
	0.254	65 to 205	48×31 to 152×96
	0.508	60 to 295	44×28 to 218×138
Code128	0.2	75 to 185	55×35 to 137×87
UPC	0.33	50 to 220	37×23 to 163×103

## V400-R2CF65 2D code (typical example)

Code types	Resolution	Reading distance	Field-of-view size at reading distance
QR Code	0.169	60 to 80	44×28 to 59×38
	0.381	35 to 115	26×16 to 85×54
Data Matrix	0.212	55 to 90	41×26 to 67×42
PDF417	0.127	55 to 80	41×26 to 59×38
	0.254	55 to 115	41×26 to 85×54

## Bar code (typical example)

Code types	Resolution	Reading distance	Field-of-view size at reading distance
Code39	0.076	60 to 65	44×28 to 48×31
	0.127	55 to 85	41×26 to 63×40
	0.254	50 to 115	37×23 to 85×54
Code128	0.18	45 to 100	33×21 to 74×47
UPC	0.33	45 to 120	33×21 to 89×56

# Dimensions

(Unit: mm)

## Multi Code Reader V400-R2CF65/R2CF125

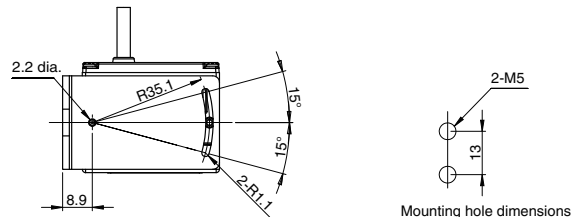
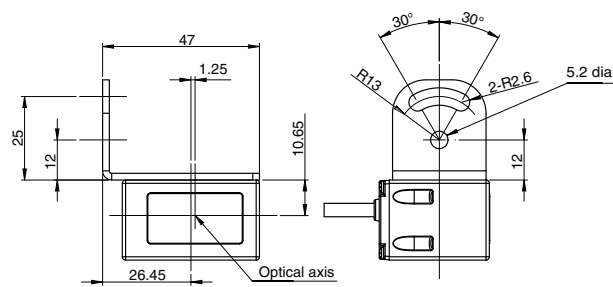
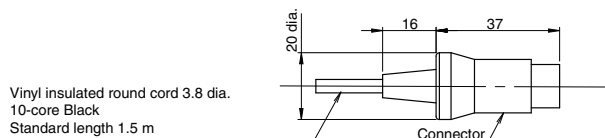
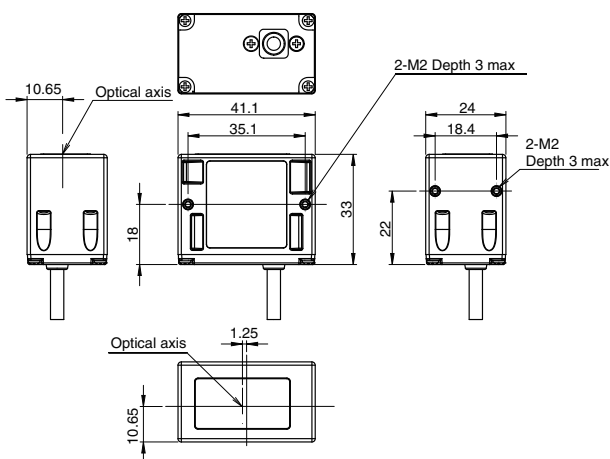

# Related Manuals

Man.No.	Model number	Manual
Z333	V400-R2	Multi Code Reader V400-R2 Series User's Manual

Multi Code Reader FQ-CR1 series

2D Code Reader for DPM FQ-CR2 series



# Highly Advanced, Multi-functional Code Reader That Can Handle Low-contrast and Glossy Surfaces

## Multi Code Reader FQ-CR1 Series



## 2D Code Reader for Direct Part Marking codes FQ-CR2 Series



FQ-CR1

FQ-CR2

### High-power LEDs

The wider the field of view, the more difficult it is to maintain consistent lighting within the field, causing errors in reading. The built-in LEDs of the FQ-CR Series use a unique OMRON DR optical system for effective light usage to maintain consistent lighting within the field of view at a brightness that is four times that of previous models.



Previous Lighting



High-power Lighting

### HDR Function to Cut Out Ambient Light Interference

The HDR (high dynamic range) function minimizes the influence of changes in lighting conditions and light reflection. This enables stable inspections even for materials that are difficult to light evenly, such as metal parts or glossy films, or in locations subject to external light interference.

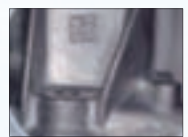

Halation

Stable Detection for  
Metal Surfaces Subject to  
Gloss and Inconsistent  
Lighting

### Polarizing Filter to Cut Specular Reflections

A polarizing filter is included to cut specular reflection from glossy surfaces. This enables stable code reading even for metallic or other glossy surfaces.



Without Polarizing Filter



With Polarizing Filter

### Connection of Up to 32 Readers

Up to 32 Code Readers can be controlled from the Touch Finder setup console. Expansion of required processes is simple.

Connect up to 32 readers



FQ-CR2

## Removing Printing Irregularities or Noise

You can apply up to three of the four unique filters developed by OMRON in the desired order to remove printing irregularities and noise, in order to achieve a stable reading.

### Combining Filtering

Erosion and dilation can be combined to connect dots without changing the dot thickness.



### Types of Filtering

<b>Smooth</b>	Smooths the image.	<b>Erosion</b>	For white codes, reduces the cell size. Effective for reading separated dot codes.
<b>Dilate</b>	For white codes, increases the cell size. Effective for reading codes with cell spreading.	<b>Median</b>	Removes noise.

## Retry Reading Until Successful

Code Readers must be able to read codes even for poor printing conditions. You can automatically retry reading while changing the exposure time and other reading conditions, even for changing workpieces or environments, to enable a stable reading.

The following retry functions are provided.

- 1 Retrying the Specified Number of Times with the Same Conditions**  
 Reading is performed the specified number of times for the same scene.
- 2 Retrying While External Trigger Is Input**  
 Reading is performed until successful, as long as an external level trigger is input.
- 3 Retrying While Changing the Shutter Speed**  
 Reading is performed for the same scene while changing the exposure time in stages.
- 4 Retrying While Changing the Reading Conditions**  
 When reading DPM codes, inconsistencies in printing conditions can result in NGs if reading is performed with only one set of reading settings. The FQ-CR allows you to register up to 32 sets of reading conditions as scenes and retry reading while changing the scenes in order. The system automatically determines the scenes with the highest usage rates and changes the order to start with them to flexibly handle changes in reading conditions. Of course you can specify a fixed order if required.

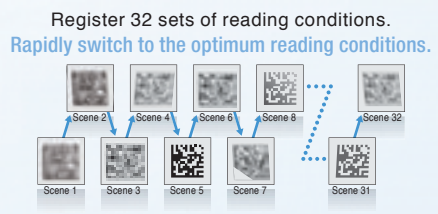

FQ-CR1

## Verification with Master Data

You can verify character strings to see if they match preset master data without a special device.

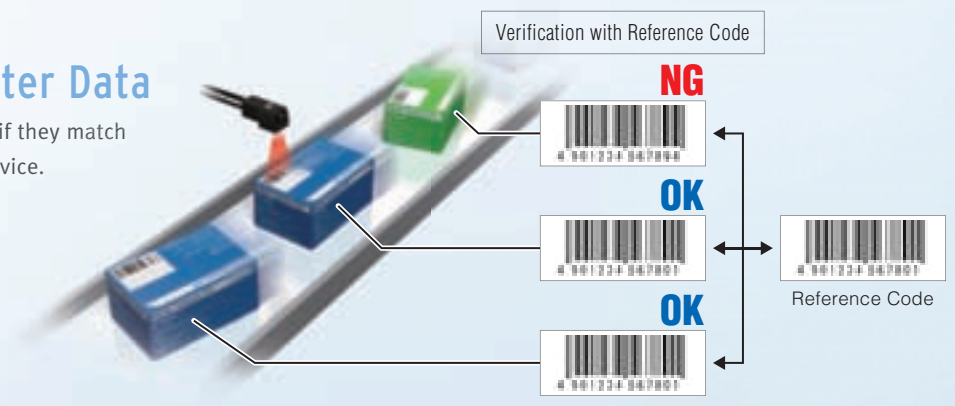

## Ordering Information

### Code Reader

(Unit: mm)

#### Narrow View

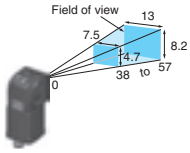

#### Standard

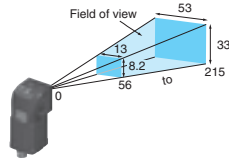

#### Wide View(Long-distance)

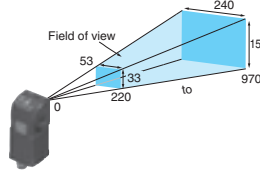

#### (Short-distance)

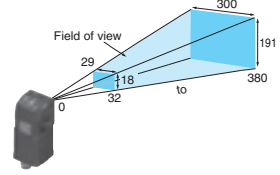

	2D CodeReader	Multi Code Reader		2D CodeReader	Multi Code Reader		2D CodeReader	Multi Code Reader		2D CodeReader	Multi Code Reader
NPN	FQ-CR20010F-M	FQ-CR10010F-M	NPN	FQ-CR20050F-M	FQ-CR10050F-M	NPN	FQ-CR20100F-M	FQ-CR10100F-M	NPN	FQ-CR20100N-M	FQ-CR10100N-M
PNP	FQ-CR25010F-M	FQ-CR15010F-M	PNP	FQ-CR25050F-M	FQ-CR15050F-M	PNP	FQ-CR25100F-M	FQ-CR15100F-M	PNP	FQ-CR25100N-M	FQ-CR15100N-M

Note: Tolerance (field of view): ±10% max.

### Touch Finder

Type	Model
DC power supply	FQ2-D30
AC/DC/battery	FQ2-D31

### Cables

Type	Cable length	Model
FQ Ethernet Cables (connect Sensor to Touch Finder, Sensor to PC)	2m	FQ-WN002
	5m	FQ-WN005
	10m	FQ-WN010
	20m	FQ-WN020
I/O Cables	2m	FQ-WD002
	5m	FQ-WD005
	10m	FQ-WD010
	20m	FQ-WD020

Refer to the FQ2 Smart Camera Catalog (Cat. No. Q193) for other devices.

## Dimensions

(Unit: mm)

### Code Reader

#### FQ-CR

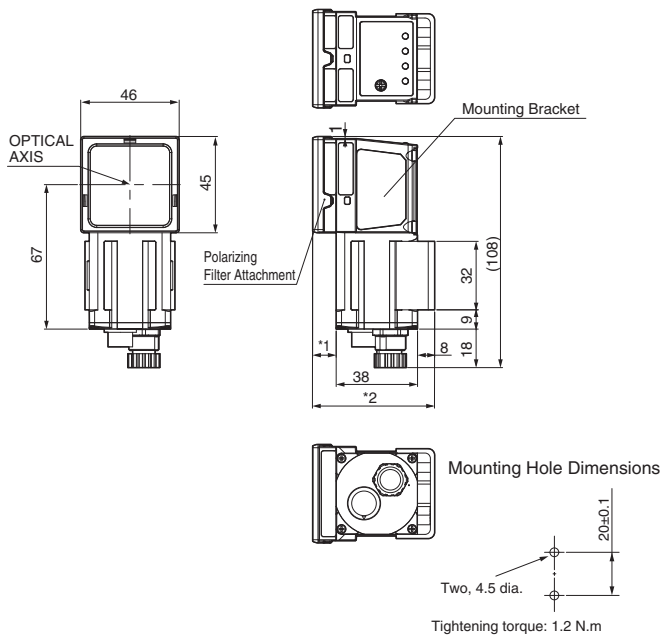

Type	Model	Note 1.	Note 2.
Narrow View, Standard	FQ-CR1□010F-M/-CR2□010F-M/-CR1□050F-M/-CR2□050F-M	11	57
Wide View	FQ-CR1□100F-M/-CR2□0100F-M/-CR1□100N-M/-CR2□100N-M	3	49

## Ratings and Performance

### Code Reader

Item	Type	2D Code Reader	Multi Code Reader
Model	NPN	FQ-CR20□□□□-M	FQ-CR10□□□□-M
	PNP	FQ-CR25□□□□-M	FQ-CR15□□□□-M
Field of view		Refer to Ordering Information on p.14 (Tolerance (field of view): ±10% max.)	
Installation distance			
Minimum resolution		FQ-CR2□010F-M/-CR1□010F-M: 0.040mm FQ-CR2□050F-M/-CR1□050F-M: 0.070mm FQ-CR2□100F-M/-CR1□100F-M: 0.282mm FQ-CR2□100N-M/-CR1□100N-M: 0.155mm	
Main functions	Code	2D Code (DataMatrix (EC200), QR Code)	2D Code (DataMatrix (EC200), QR Code, MicroQR Code, PDF417, MicroPDF417, GS1-Data Matrix Bar code (JAN/EAN/UPC, Code39, Codabar (NW-7), ITF (Interleaved 2 of 5), Code 93, Code128/GS1-128, GS1 DataBar* (Truncated, Stacked, Omni-directional, Stacked Omni-directional, Limited, Expanded and Expanded Stacked), Pharmacode and GS1-128 Composite Code (CC-A, CC-B, CC-C))
	Image filter	Filter function (Smooth, Dilate, Erosion, Median), Retry function, Code Error Correction Position Display	None
	Verification function	None	Supported
	Number of simultaneous inspections	32	
	Number of registered scenes	32	
Image input	Image filter	High dynamic range (HDR), polarizing filter (attachment)	
	Image elements	1/3-inch monochrome CMOS	
	Shutter	1/250 to 1/32,258 s	1/250 to 1/30,000 s
	Processing resolution	752 × 480	
Lighting	Lighting method	Pulse	
	Lighting color	White	
Data logging	Measurement data	In Code Reader:1,000 items (If a Touch Finder is used, results can be saved up to the capacity of an SD card.)	
	Images	In Code Reader:20 images (If a Touch Finder is used, images can be saved up to the capacity of an SD card.)	
Measurement trigger		External trigger (single or continuous), Communications trigger (Ethernet TCP no-protocol)	
I/O specifications	Input signals	7 signals • Single measurement input (TRIG) • Control command inputs (IN0 to IN5)	
	Output signals	3 signals • Control output (BUSY) • Overall judgement output (OR) • Error output (ERROR) <b>Note:</b> The three output signals can be allocated for the judgements of individual inspection items.	
	Ethernet specification	100BASE-TX/10BASE-T	
	Communications	Ethernet TCP no-protocol	
Ratings	Power supply voltage	21.6 to 26.4 VDC (including ripple)	
	Current consumption	2.4 A max.	
Environmental immunity	Ambient temperature range	Operating: 0 to 50°C Storage: -25 to 65°C (with no icing or condensation)	
	Ambient humidity range	Operating and storage: 35% to 85% (with no condensation)	
	Ambient atmosphere	No corrosive gas	
	Vibration resistance (destruction)	10 to 150 Hz, single amplitude: 0.35 mm, X/Y/Z directions 8 min each, 10 times	
	Shock resistance (destruction)	150 m/s <sup>2</sup> 3 times each in 6 direction (up, down, right, left, forward, and backward) Degree of protection	
Degree of protection	IEC 60529 IP67 (Except when Polarizing Filter Attachment is mounted.)		
Materials		Code Reader: PBT, PC, SUS Mounting Bracket: PBT Polarizing Filter Attachment: PBT, PC Ethernet connector: Oil-resistance vinyl compound I/O connector: Lead-free heat-resistant PVC	
Weight		Narrow View/Standard View:Approx.160 g Wide View:Approx.150 g	
Accessories		<ul style="list-style-type: none"> <li>• Mounting Bracket (FQ-XL) (1)</li> <li>• Polarizing Filter Attachment (FQ-XF1) (1)</li> <li>• Instruction Manual</li> </ul> <ul style="list-style-type: none"> <li>• Member registration sheet</li> </ul>	
LED class		Risk Group 2 (IEC62471-2)	
Applicable standards		EC Directive No.2004/108/EC and EN standard EN 61326-1	

### Related Manuals

Man.No.	Model number	Manual
Z329	FQ-CR1-M	Fixed Mount Multi Code Reader FQ-CR1-M User's manual
Z316	FQ-CR2-M	Fixed Mount 2D Code Reader FQ-CR2-M User's manual



# An OCR Sensor with Built-in Dictionary for Reading Expiration Dates and Lot Numbers

Optical Character Recognition Sensor  
FQ-CH Series



## Approx. 80 Built-in Fonts

The large amount of data in the built-in dictionary contains approximately 80 different fonts that are used on FA sites. Variations for worn characters, blurring, distortion, different backgrounds, and size changes have been included to enable stable and highly accurate reading with the built-in dictionary even for some variations in the characters. It is not necessary to set parameters to compensate for character contrast or positional offsetting.

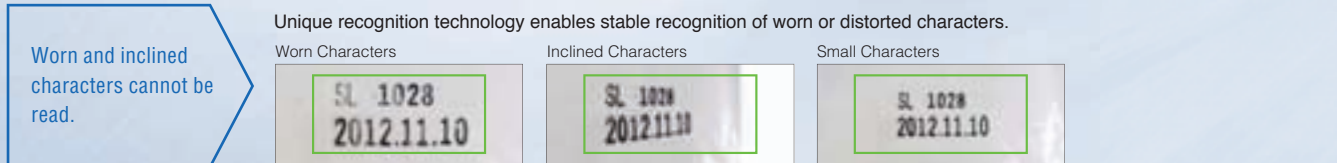
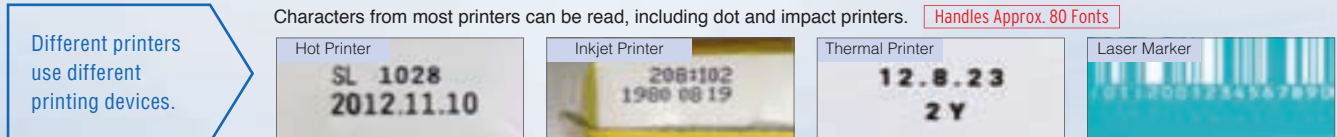
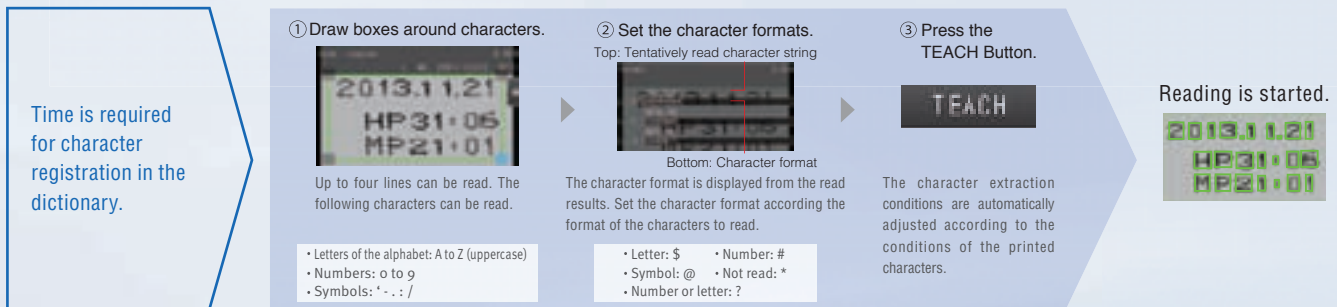



# Utilities That Make Everyday Operation Easier

## Verification to Reduce Setup Work

You can verify the read character data against the character data registered in the master data. Master data registration is easy. A character string is read and the result is registered in the master data. This reduces setting time and mistakes in setting character strings. You can register up to 32 character strings in the master data and easily change the current master data with an external signal.

0.Master data 0	SL1028	^
1.Master data 1	201211	
2.Master data 2	28L	
3.Master data 3	WP31:06	
4.Master data 4	???:??	
5.Master data 5	HP/2013	v

## Registration in Model Dictionary

You can add characters to the dictionary. You can achieve reliable operation when reading special fonts even if reading was not stable with the default settings.

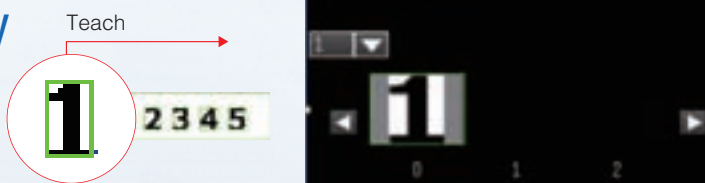

## Logging Images and Reading Data

The read images and reading results can be temporarily saved in the sensor, and up to 10,000 images and 10,000,000 reading results can be saved in a 4-GB SD card. You can select logging both OK and NG results or only NG results to aid in traceability.

Sensor

Images: 20  
Reading results: 1,000 max.

Touch Finder

Images: Approx. 10,000  
Reading results: Approx. 10,000,000 (with 4-GB SD card)

## New OCR Algorithm: Matching with Structural Models

Even in cases like the following one, where character registration is required for image matching methods, no character registration is required to read the characters with this new method, which matches structural models of characteristic points.

Structural models record the characteristics of each character in approximately 80 fonts.

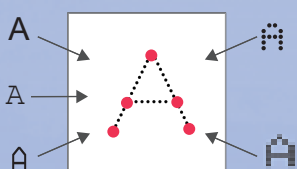

The position and structure of characteristic points are used to recognize characters.

Background Changes

Size and Font Changes

Worn Characters

Inclined Characters

# Optical Character Recognition Sensor FQ2-CH

## Ordering Information

### Optical Character Recognition Sensor

(Unit: mm)

Narrow View

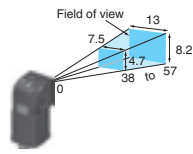

Standard

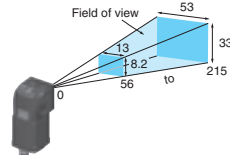

Wide View(Long-distance)

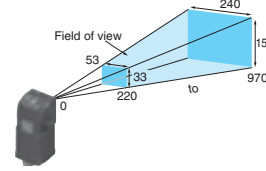

(Short-distance)

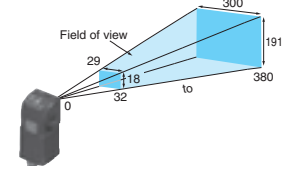

Field of view		Narrow View	Standard View	Wide View (Long-distance)	Wide View (Short-distance)
Monochrome	NPN	FQ2-CH10010F-M	FQ2-CH10050F-M	FQ2-CH10100F-M	FQ2-CH10100N-M
	PNP	FQ2-CH15010F-M	FQ2-CH15050F-M	FQ2-CH15100F-M	FQ2-CH15100N-M

### Touch Finder

Type	Model
DC power supply	FQ2-D30
AC/DC/battery	FQ2-D31

### Cables

Type	Cable length	Model
FQ Ethernet Cables (connect Sensor to Touch Finder, Sensor to PC)	2m	FQ-WN002
	5m	FQ-WN005
	10m	FQ-WN010
	20m	FQ-WN020
I/O Cables	2m	FQ-WD002
	5m	FQ-WD005
	10m	FQ-WD010
	20m	FQ-WD020

Refer to the FQ2 Smart Camera Catalog (Cat. No. Q193) for other devices.

## Dimensions

(Unit: mm)

### Optical Character Recognition Sensor

#### FQ2-CH

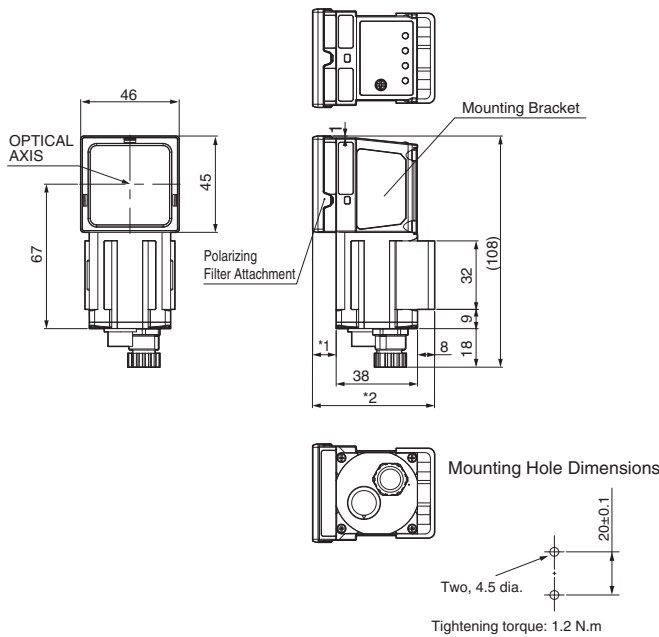

Type	Model	Note 1.	Note 2.
Narrow View, Standard	FQ2-CH1□010F-M/-CH1□050F-M	11	57
Wide View	FQ2-CH1□100F-M/-CH1□100N-M	3	49

## Ratings and Performance

Item		Optical Character Recognition Sensor
Model	NPN	FQ2-CH10□□□□-M
	PNP	FQ2-CH15□□□□-M
Field of view		Refer to Ordering Information on p.18. (Tolerance (field of view): ±10% max.)
Installation distance		
Main functions	Inspection items	OCR <ul style="list-style-type: none"> <li>• Alphabet A to Z</li> <li>• Number 0 to 9</li> <li>• Symbol ' - . : /</li> </ul> Model dictionary
	Image filter	Weak smoothing, Strong smoothing, Dilate, Erosion, Median, Extract edges, Extract horizontal edges, Extract vertical edges, Enhance edges, Background suppression
	Verification function	Supported
	Retry function	Normal retry, Exposure retry, Scene retry, Trigger retry
	Number of simultaneous measurements	32
	Position compensation	Supported (360° Model position compensation, Edge position compensation)
	Number of registered scenes	32
Image input	Image processing method	Monochrome
	Image filter	High dynamic range (HDR) and polarizing filter (attachment)
	Image elements	1/3-inch Monochrome CMOS
	Shutter	Built-in lighting ON: 1/250 to 1/50,000 s Built-in lighting OFF: 1/1 to 1/50,000 s
	Processing resolution	752 × 480
	Partial input function	Supported horizontally only
Lighting	Lighting method	Pulse
	Lighting color	White
Data logging	Measurement data	In Sensor: 1,000 items (If a Touch Finder is used, results can be saved up to the capacity of an SD card.)
	Images	In Sensor: 20 images (If a Touch Finder is used, images can be saved up to the capacity of an SD card.)
Auxiliary function		Math (arithmetic, calculation functions, trigonometric functions, and logic functions)
Measurement trigger		External trigger (single or continuous) Communications trigger (Ethernet TCP no-protocol, Ethernet UDP no-protocol, Ethernet FINS/TCP no-protocol, EtherNet/IP, PLC Link, or PROFINET)
I/O specifications	Input signals	7 signals <ul style="list-style-type: none"> <li>• Single measurement input (TRIG)</li> <li>• Control command input (IN0 to IN5)</li> </ul>
	Output signals	3 signals <ul style="list-style-type: none"> <li>• Control output (BUSY)</li> <li>• Overall judgement output (OR)</li> <li>• Error output (ERROR)</li> </ul> <b>Note:</b> The assignments of the three output signals (OUT0 to OUT2) can be changed to the individual judgements of the inspection items, the image input ready output (READY), or the external lighting timing output (STGOUT).
	Ethernet specifications	100Base-TX/10Base-T
	Communications	Ethernet TCP no-protocol, Ethernet UDP no-protocol, Ethernet FINS/TCP no-protocol, EtherNet/IP, PLC Link, or PROFINET
	I/O expansion	Possible by connecting FQ-SDU1_ Sensor Data Unit. 11 inputs and 24 outputs
	RS-232C	Possible by connecting FQ-SDU2_ Sensor Data Unit. 8 inputs and 7 outputs
Ratings	Power supply voltage	21.6 to 26.4 VDC (including ripple)
	Current consumption	2.4 A max.
Environmental immunity	Ambient temperature range	Operating: 0 to 40°C, Storage: -25 to 65°C (with no icing or condensation)
	Ambient humidity range	Operating and storage: 35% to 85% (with no condensation)
	Ambient atmosphere	No corrosive gas
	Vibration resistance(destruction)	10 to 150 Hz, single amplitude: 0.35 mm, X/Y/Z directions 8 min each, 10 times
	Shock resistance(destruction)	150 m/s <sup>2</sup> 3 times each in 6 direction (up, down, right, left, forward, and backward)
	Degree of protection	IEC 60529 IP67 (Except when Polarizing Filter Attachment is mounted or connector cap is removed.)
Materials		Sensor: PBT, PC, SUS, Mounting Bracket: PBT, Polarizing Filter Attachment: PBT, PC Ethernet connector: Oil-resistance vinyl compound, I/O connector: Lead-free heat-resistant PVC
Weight		Narrow View/Standard View: Approx.160 g Wide View: Approx.150 g
Accessories included with sensor		Mounting Bracket (FQ-XL) (1), Polarizing Filter Attachment (FQ-XF1) (1), Instruction Manual, Member Registration Sheet
LED class		Risk Group 2 (IEC 62471)
Applicable standards		EC Directive No.2004/108/EC and EN standard EN 61326-1

## Related Manuals

Man.No.	Model number	Manual
Z337	FQ2-S1/S2/S3/S4/CH	Smart Camera FQ2-S/CH Series User's manual
Z338	FQ2-S1/S2/S3/S4/CH	Smart Camera FQ2-S/CH Series User's manual (Communication Settings)

\* EtherNet/IP™ is the trademark of ODVA.

## Smart Camera



# The High End of OMRON Tracing Products That Operates as a Code Reader or OCR and Also Performs Inspections

Smart Camera  
FQ2-S4 Series



## A Complete Range of Top-end Functions

A complete set of functions for stable reading even with low contrast or shiny surfaces along with high-demand communications interfaces. Printed character checking, Bar Code checking, packaging condition inspections, and much more with just one Smart Camera.

<b>Code Reader</b>	<b>High-speed</b> image processor	Megapixel capacity	Real color	Monochrome	<b>C</b> -mount	<b>9</b> inspection items	<b>11</b> image filters	<b>32</b> -camera expansion	<b>360°</b> position compensation	<b>Ultra-wide</b> field of view	<b>DAP</b> partial input
<b>OCR</b>	<b>HDR</b>	Sub-pixel processing	High-power lighting	<b>IP67</b>	<b>E-IP</b>	<b>PLC</b> Link	<b>FINS</b>	<b>34 I/O</b> points	<b>RS-232C</b>	Password	Image inversion

## Reads both Codes and Characters in One View with 1.3 Megapixels

It is generally said that a resolution of 700,000 pixels or higher is required to read both codes and characters in one field of view. The FQ2-S4 Series includes 760,000-pixel models with built-in lighting as well as 1,300,000-pixel models with C-mounts for a flexible selection of fields of view so you can stably read information-heavy codes with one read image.

**Megapixel CMOS Sensor**

1.3 Megapixels	760,000 Pixels
<b>Color</b>   Monochrome	<b>Color</b>   Monochrome

Sensor with C-mount      Integrated Sensor

**350,000-pixel Image**

**1,300,000-pixel Image**

## Code and Character Verification

OCR and Code Reading inspection items can be combined to read codes and verify them against character strings all within the FQ2. No programming of external devices is required.

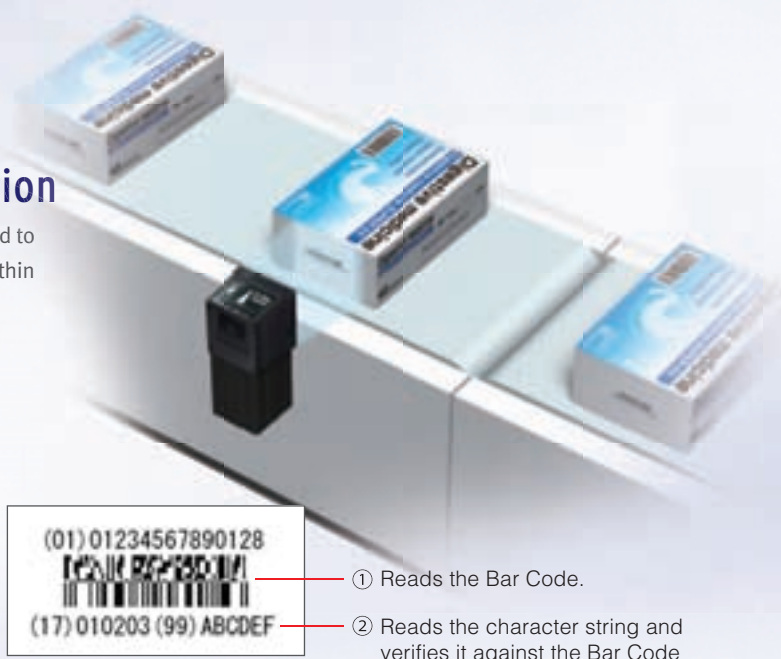
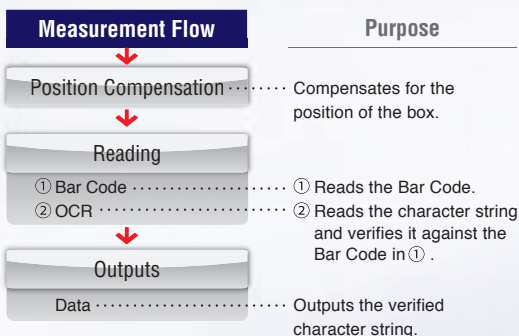

① Reads the Bar Code.  
② Reads the character string and verifies it against the Bar Code

## Character Verification and Label Position Inspection

Although previously performed as separate processes, character verification and inspections can now both be performed with one FQ2 Sensor. This helps you reduce costs and save space.

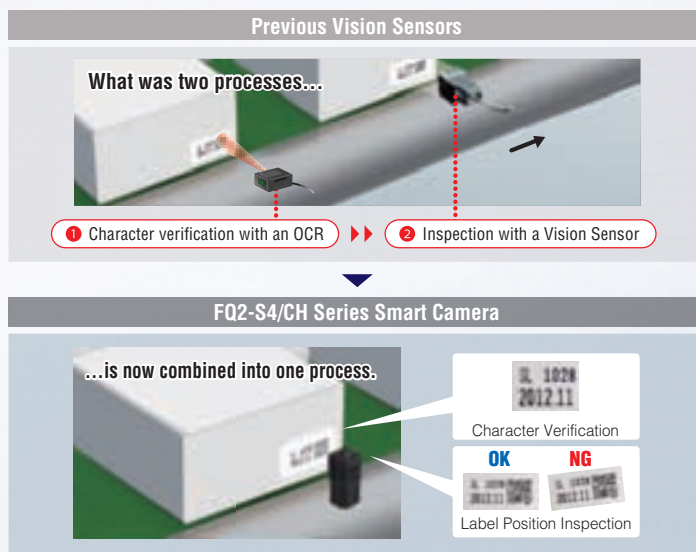
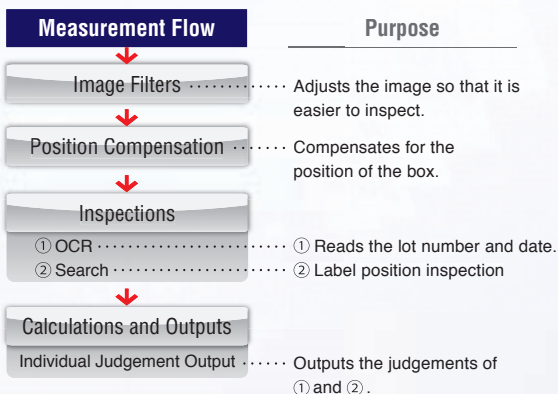

## Code Reading and Component Positioning

The Sensor can measure angles of rotation and other position information, so it can also be used for positioning. Inspections can also be performed for the number and size of holes along with the position information.

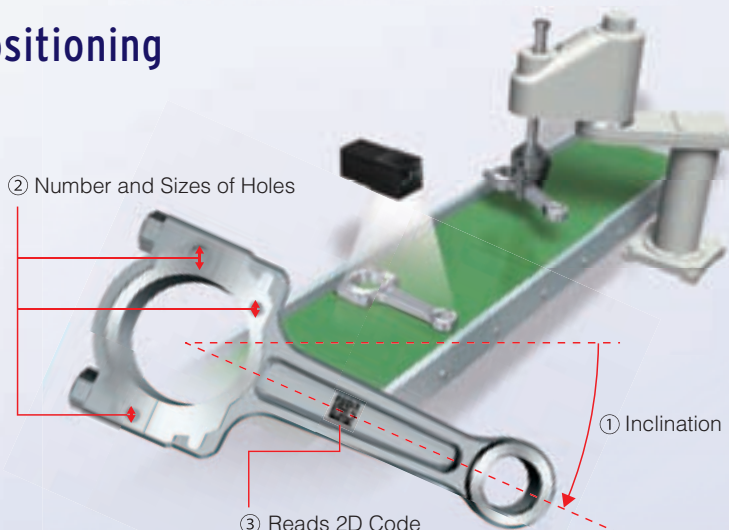
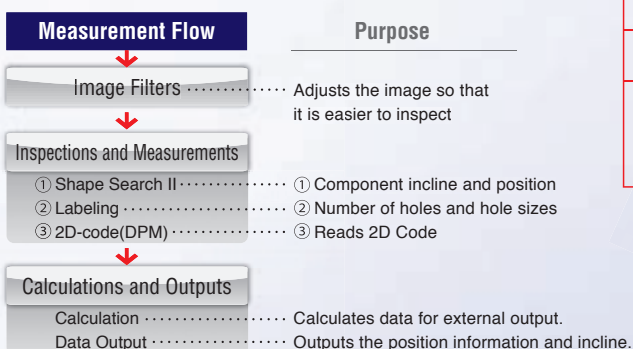

## Ordering Information

### Smart Camera

(Unit: mm)

[Standard Type]

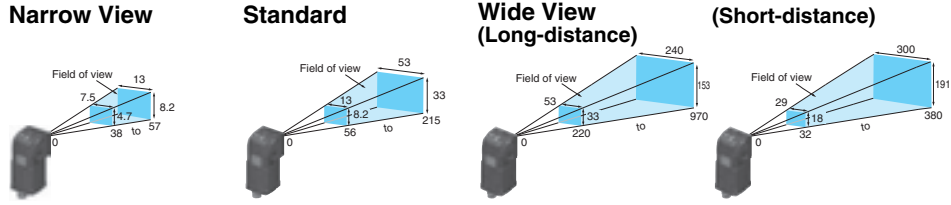

Field of view		Narrow View	Standard View	Wide View (Long-distance)	Wide View (Short-distance)
Number of pixels		350,000 pixels			
Color	NPN	FQ2-S40010F	FQ2-S40050F	FQ2-S40100F	FQ2-S40100N
	PNP	FQ2-S45010F	FQ2-S45050F	FQ2-S45100F	FQ2-S45100N
Monochrome	NPN	FQ2-S40010F-M	FQ2-S40050F-M	FQ2-S40100F-M	FQ2-S40100N-M
	PNP	FQ2-S45010F-M	FQ2-S45050F-M	FQ2-S45100F-M	FQ2-S45100N-M

[High-resolution Type]

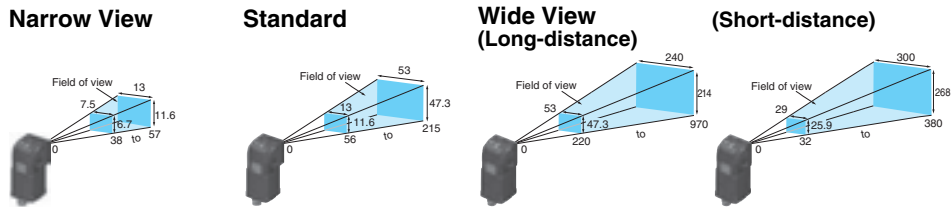

C-mount type needs a lens. Refer to the optical chart on the FQ2 Catalog (Cat. No. Q193).

Field of view		Narrow View	Standard View	Wide View (Long-distance)	Wide View (Short-distance)	C-mount
Number of pixels		760,000 pixels				1.3 million pixels
Color	NPN	FQ2-S40010F-08	FQ2-S40050F-08	FQ2-S40100F-08	FQ2-S40100N-08	FQ2-S40-13
	PNP	FQ2-S45010F-08	FQ2-S45050F-08	FQ2-S45100F-08	FQ2-S45100N-08	FQ2-S45-13
Monochrome	NPN	FQ2-S40010F-08M	FQ2-S40050F-08M	FQ2-S40100F-08M	FQ2-S40100N-08M	FQ2-S40-13M
	PNP	FQ2-S45010F-08M	FQ2-S45050F-08M	FQ2-S45100F-08M	FQ2-S45100N-08M	FQ2-S45-13M

Refer to the FQ2 Smart Camera Catalog (Cat. No. Q193) for other devices.

## Dimensions

(Unit: mm)

### Integrated Sensor FQ2-S4□□□□□□ (-□□□)

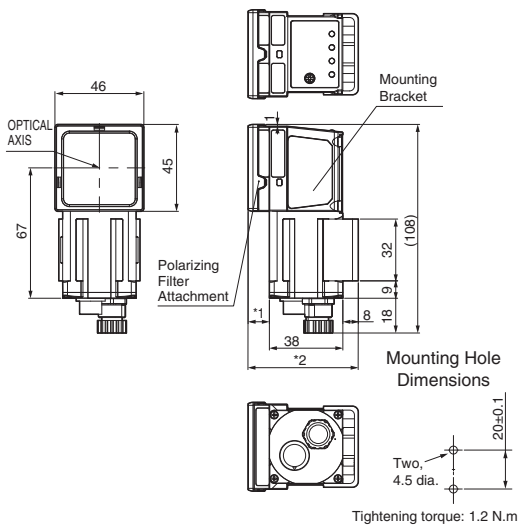

### C-mount FQ2-S4□-13□

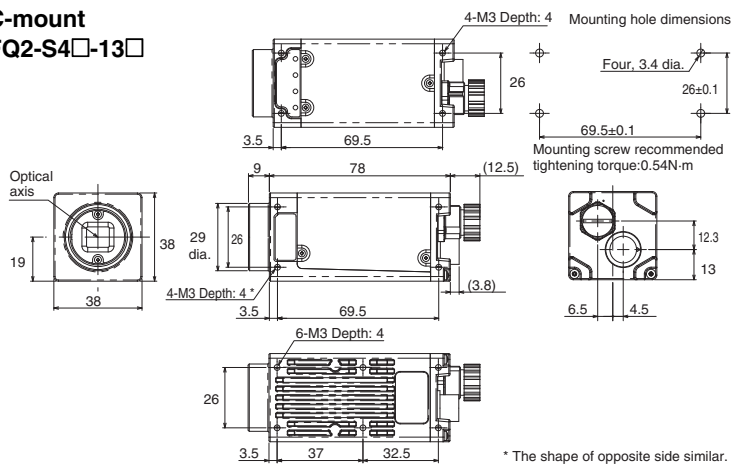

### Mounting Base FQ-XLC (included with Sensor)

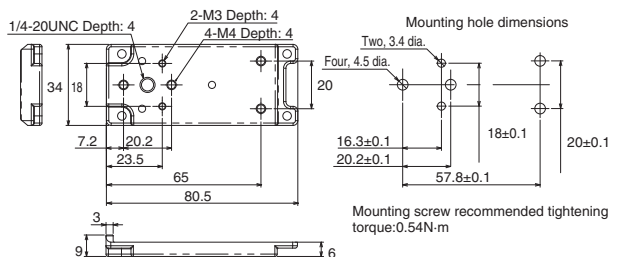

\* Dimensions with the Mounting Bracket

Type	Model	Note 1.	Note 2.
Narrow View, Standard	FQ2-S4□010F (-□□□)	11	57
	FQ2-S4□050F (-□□□)		
Wide View	FQ2-S4□100F (-□□□)	3	49
	FQ2-S4□100N (-□□□)		

## Ratings and Performance

### Sensor [Inspection/ID Model FQ2-S4 Series]

Item		Inspection/ID Model						
Model	NPN	FQ2-S40□□□□	FQ2-S40□□□□-M	FQ2-S40□□□□-08	FQ2-S40□□□□-08M	FQ2-S40□□□□-13	FQ2-S40□□□□-13M	
	PNP	FQ2-S45□□□□	FQ2-S45□□□□-M	FQ2-S45□□□□-08	FQ2-S45□□□□-08M	FQ2-S45□□□□-13	FQ2-S45□□□□-13M	
Field of view							Select a lens according to the field of view and installation distance.	
Installation distance		Refer to Ordering Information on p.22. (Tolerance (field of view): ±10% max.)					Refer to the optical chart on the FQ2 Catalog (Cat. No. Q193).	
Main functions	Inspection items	Search, shape search II, sensitive search, area, color data, edge position, edge pitch, edge width, labeling, OCR *1, Bar code *2, 2D-code *2, 2D-code(DMP) *3, and Model dictionary						
	Number of simultaneous measurements	32						
	Position compensation	Supported (360° Model position compensation, Edge position compensation)						
	Number of registered scenes	32 *4						
	Calibration	Supported						
Retry function		Normal retry, Exposure retry, Scene retry, Trigger retry						
Image input	Image processing method	Real color	Monochrome	Real color	Monochrome	Real color	Monochrome	
	Image filter	High dynamic range (HDR), image adjustment(Color Gray Filter, Weak smoothing, Strong smoothing, Dilate, Erosion, Median, Extract edges, Extract horizontal edges, Extract vertical edges, Enhance edges, Background suppression), polarizing filter (attachment), and white balance (Sensors with Color Cameras only)						
	Image elements	1/3-inch color CMOS	1/3-inch Monochrome CMOS	1/2-inch color CMOS	1/2-inch Monochrome CMOS	1/2-inch color CMOS	1/2-inch Monochrome CMOS	
	Shutter	Built-in lighting ON: 1/250 to 1/50,000 s Built-in lighting OFF: 1/1 to 1/50,000 s		Built-in lighting ON: 1/250 to 1/60,000 s Built-in lighting OFF: 1/1 to 1/4,155 s		1/1 to 1/4,155 s		
	Processing resolution	752 × 480		928 × 828		1280 × 1024		
	Partial input function	Supported horizontally only.		Supported horizontally and vertically				
	Lens mounts	---					C-mount	
Lighting	Lighting method	Pulse					---	
	Lighting color	White					---	
Data logging	Measurement data	In Sensor: 1,000 items (If a Touch Finder is used, results can be saved up to the capacity of an SD card.)						
	Images	In Sensor: 20 images (If a Touch Finder is used, images can be saved up to the capacity of an SD card.)						
Auxiliary function		Math (arithmetic, calculation functions, trigonometric functions, and logic functions)						
Measurement trigger		External trigger (single or continuous) Communications trigger (Ethernet TCP no-protocol, Ethernet UDP no-protocol, Ethernet FINS/TCP no-protocol, EtherNet/IP, PLC Link, or PROFINET)						
I/O specifications	Input signals	7 signals • Single measurement input (TRIG) • Control command input (IN0 to IN5)						
	Output signals	3 signals • Control output (BUSY) • Overall judgement output (OR) • Error output (ERROR) <b>Note:</b> The assignments of the three output signals (OUT0 to OUT2) can be changed to the individual judgements of the inspection items, the image input ready output (READY), or the external lighting timing output (STGOUT).						
	Ethernet specifications	100Base-TX/10Base-T						
	Communications	Ethernet TCP no-protocol, Ethernet UDP no-protocol, Ethernet FINS/TCP no-protocol, EtherNet/IP, PLC Link, or PROFINET						
	I/O expansion	Possible by connecting FQ-SDU1_ Sensor Data Unit. 11 inputs and 24 outputs						
RS-232C		Possible by connecting FQ-SDU2_ Sensor Data Unit. 8 inputs and 7 outputs						
Ratings	Power supply voltage	21.6 to 26.4 VDC (including ripple)						
	Current consumption	2.4 A max.				0.3 A max.		
Environmental immunity	Ambient temperature range	Operating: 0 to 40°C, Storage: -25 to 65°C (with no icing or condensation)						
	Ambient humidity range	Operating and storage: 35% to 85% (with no condensation)						
	Ambient atmosphere	No corrosive gas						
	Vibration resistance (destruction)	10 to 150 Hz, single amplitude: 0.35 mm, X/Y/Z directions 8 min each, 10 times						
	Shock resistance (destruction)	150 m/s <sup>2</sup> 3 times each in 6 direction (up, down, right, left, forward, and backward)						
Degree of protection		IEC 60529 IP67 (Except when Polarizing Filter Attachment is mounted or connector cap is removed.)				IEC 60529 IP40		
Materials		Sensor: PBT, PC, SUS Mounting Bracket: PBT Polarizing Filter Attachment: PBT, PC Ethernet connector: Oil-resistance vinyl compound I/O connector: Lead-free heat-resistant PVC				Cover: Zinc-plated steel, Thickness: 0.6 mm Case: Aluminum diecast alloy (ADC-12) Mounting base: Polycarbonate ABS		
Weight		Narrow View/Standard View: Approx. 160 g Wide View: Approx. 150 g				Approx. 160 g without base, Approx. 185 g with base		
Accessories included with sensor		Mounting Bracket (FQ-XL)(1) Polarizing Filter Attachment (FQ-XF1) (1) Instruction Manual, Member Registration Sheet				Mounting Base (FQ-XLC) (1) Mounting Screw (M3 × 8mm)(4) Instruction Manual, Member Registration Sheet		
LED class		Risk Group 2 (IEC 62471)						
Applicable standards		EC Directive No.2004/108/EC and EN standard EN 61326-1						

\*1. The types of characters to be read are the same as those of FQ2-CH Optical Character Recognition Sensor (p.19).

\*2. The types of cedes to be read are the same as those of FQ-CR1 Multi Code Reader (p.15).

\*3. The types of cedes to be read are the same as those of FQ-CR2 2D Code Reader (p.15).

\*4. Depending on the settings, the number of scenes that can be registered is reduced due to memory restrictions.

## Related Manuals

Man.No.	Model number	Manual
Z337	FQ2-S1/S2/S3/S4/CH	Smart Camera FQ2-S/CH Series User's manual
Z338	FQ2-S1/S2/S3/S4/CH	Smart Camera FQ2-S/CH Series User's manual (Communication Settings)

## **READ AND UNDERSTAND THIS CATALOG**

Please read and understand this catalog before purchasing the products. Please consult your OMRON representative if you have any questions or comments.

## **WARRANTY**

OMRON's exclusive warranty is that the products are free from defects in materials and workmanship for a period of one year (or other period if specified) from date of sale by OMRON.

OMRON MAKES NO WARRANTY OR REPRESENTATION, EXPRESS OR IMPLIED, REGARDING NON-INFRINGEMENT, MERCHANTABILITY, OR FITNESS FOR PARTICULAR PURPOSE OF THE PRODUCTS. ANY BUYER OR USER ACKNOWLEDGES THAT THE BUYER OR USER ALONE HAS DETERMINED THAT THE PRODUCTS WILL SUITABLY MEET THE REQUIREMENTS OF THEIR INTENDED USE. OMRON DISCLAIMS ALL OTHER WARRANTIES, EXPRESS OR IMPLIED.

## **LIMITATIONS OF LIABILITY**

OMRON SHALL NOT BE RESPONSIBLE FOR SPECIAL, INDIRECT, OR CONSEQUENTIAL DAMAGES, LOSS OF PROFITS OR COMMERCIAL LOSS IN ANY WAY CONNECTED WITH THE PRODUCTS, WHETHER SUCH CLAIM IS BASED ON CONTRACT, WARRANTY, NEGLIGENCE, OR STRICT LIABILITY.

In no event shall responsibility of OMRON for any act exceed the individual price of the product on which liability is asserted.

IN NO EVENT SHALL OMRON BE RESPONSIBLE FOR WARRANTY, REPAIR, OR OTHER CLAIMS REGARDING THE PRODUCTS UNLESS OMRON'S ANALYSIS CONFIRMS THAT THE PRODUCTS WERE PROPERLY HANDLED, STORED, INSTALLED, AND MAINTAINED AND NOT SUBJECT TO CONTAMINATION, ABUSE, MISUSE, OR INAPPROPRIATE MODIFICATION OR REPAIR.

## **SUITABILITY FOR USE**

THE PRODUCTS CONTAINED IN THIS CATALOG ARE NOT SAFETY RATED. THEY ARE NOT DESIGNED OR RATED FOR ENSURING SAFETY OF PERSONS, AND SHOULD NOT BE RELIED UPON AS A SAFETY COMPONENT OR PROTECTIVE DEVICE FOR SUCH PURPOSES. Please refer to separate catalogs for OMRON's safety rated products.

OMRON shall not be responsible for conformity with any standards, codes, or regulations that apply to the combination of products in the customer's application or use of the product.

At the customer's request, OMRON will provide applicable third party certification documents identifying ratings and limitations of use that apply to the products. This information by itself is not sufficient for a complete determination of the suitability of the products in combination with the end product, machine, system, or other application or use.

The following are some examples of applications for which particular attention must be given. This is not intended to be an exhaustive list of all possible uses of the products, nor is it intended to imply that the uses listed may be suitable for the products:

- Outdoor use, uses involving potential chemical contamination or electrical interference, or conditions or uses not described in this document.
- Nuclear energy control systems, combustion systems, railroad systems, aviation systems, medical equipment, amusement machines, vehicles, safety equipment, and installations subject to separate industry or government regulations.
- Systems, machines, and equipment that could present a risk to life or property.

Please know and observe all prohibitions of use applicable to the products.

NEVER USE THE PRODUCTS FOR AN APPLICATION INVOLVING SERIOUS RISK TO LIFE OR PROPERTY WITHOUT ENSURING THAT THE SYSTEM AS A WHOLE HAS BEEN DESIGNED TO ADDRESS THE RISKS, AND THAT THE OMRON PRODUCT IS PROPERLY RATED AND INSTALLED FOR THE INTENDED USE WITHIN THE OVERALL EQUIPMENT OR SYSTEM.

## **PERFORMANCE DATA**

Performance data given in this document is provided as a guide for the user in determining suitability and does not constitute a warranty. It may represent the result of OMRON's test conditions, and the users must correlate it to actual application requirements. Actual performance is subject to the OMRON Warranty and Limitations of Liability.

## **CHANGE IN SPECIFICATIONS**

Product specifications and accessories may be changed at any time based on improvements and other reasons.

It is our practice to change model numbers when published ratings or features are changed, or when significant construction changes are made. However, some specifications of the product may be changed without any notice. When in doubt, special model numbers may be assigned to fix or establish key specifications for your application on your request. Please consult with your OMRON representative at any time to confirm actual specifications of purchased products.

## **DIMENSIONS AND WEIGHTS**

Dimensions and weights are nominal and are not to be used for manufacturing purposes, even when tolerances are shown.

## **ERRORS AND OMISSIONS**

The information in this document has been carefully checked and is believed to be accurate; however, no responsibility is assumed for clerical, typographical, or proofreading errors, or omissions.

## **PROGRAMMABLE PRODUCTS**

OMRON shall not be responsible for the user's programming of a programmable product, or any consequence thereof.

## **COPYRIGHT AND COPY PERMISSION**

This document shall not be copied for sales or promotions without permission.

This document is protected by copyright and is intended solely for use in conjunction with the product. Please notify us before copying or reproducing this document in any manner, for any other purpose. If copying or transmitting this document to another, please copy or transmit it in its entirety.

Note: Do not use this document to operate the Unit.

**OMRON Corporation Industrial Automation Company**  
Tokyo, JAPAN

Contact: [www.ia.omron.com](http://www.ia.omron.com)

### ***Regional Headquarters***

#### **OMRON EUROPE B.V.**

Wegalaan 67-69-2132 JD Hoofddorp

The Netherlands

Tel: (31)2356-81-300/Fax: (31)2356-81-388

#### **OMRON ELECTRONICS LLC**

One Commerce Drive Schaumburg,

IL 60173-5302 U.S.A.

Tel: (1) 847-843-7900/Fax: (1) 847-843-7787

#### **OMRON ASIA PACIFIC PTE. LTD.**

No. 438A Alexandra Road # 05-05/08 (Lobby 2),

Alexandra Technopark,

Singapore 119967

Tel: (65) 6835-3011/Fax: (65) 6835-2711

#### **OMRON (CHINA) CO., LTD.**

Room 2211, Bank of China Tower,

200 Yin Cheng Zhong Road,

PuDong New Area, Shanghai, 200120, China

Tel: (86) 21-5037-2222/Fax: (86) 21-5037-2200

**Authorized Distributor:**

© OMRON Corporation 2013 All Rights Reserved.  
In the interest of product improvement,  
specifications are subject to change without notice.

CSM\_9\_1\_1114

Cat. No. Q195-E1-01

Printed in Japan

0313(0313)



# Mouser Electronics

Authorized Distributor

Click to View Pricing, Inventory, Delivery & Lifecycle Information:

Omron:

[V400-R2CF65](#) [V500-R2CF](#) [V400-R2CF125](#)



Компания «ЭлектроПласт» предлагает заключение долгосрочных отношений при поставках импортных электронных компонентов на взаимовыгодных условиях!

Наши преимущества:

- Оперативные поставки широкого спектра электронных компонентов отечественного и импортного производства напрямую от производителей и с крупнейших мировых складов;
- Поставка более 17-ти миллионов наименований электронных компонентов;
- Поставка сложных, дефицитных, либо снятых с производства позиций;
- Оперативные сроки поставки под заказ (от 5 рабочих дней);
- Экспресс доставка в любую точку России;
- Техническая поддержка проекта, помощь в подборе аналогов, поставка прототипов;
- Система менеджмента качества сертифицирована по Международному стандарту ISO 9001;
- Лицензия ФСБ на осуществление работ с использованием сведений, составляющих государственную тайну;
- Поставка специализированных компонентов (Xilinx, Altera, Analog Devices, Intersil, Interpoint, Microsemi, Aeroflex, Peregrine, Syfer, Eurofarad, Texas Instrument, Miteq, Cobham, E2V, MA-COM, Hittite, Mini-Circuits, General Dynamics и др.);

Помимо этого, одним из направлений компании «ЭлектроПласт» является направление «Источники питания». Мы предлагаем Вам помощь Конструкторского отдела:

- Подбор оптимального решения, техническое обоснование при выборе компонента;
- Подбор аналогов;
- Консультации по применению компонента;
- Поставка образцов и прототипов;
- Техническая поддержка проекта;
- Защита от снятия компонента с производства.



#### Как с нами связаться

**Телефон:** 8 (812) 309 58 32 (многоканальный)

**Факс:** 8 (812) 320-02-42

**Электронная почта:** [org@eplast1.ru](mailto:org@eplast1.ru)

**Адрес:** 198099, г. Санкт-Петербург, ул. Калинина, дом 2, корпус 4, литера А.