

ADG431/ADG432/ADG433

FEATURES

- 44 V Supply Maximum Ratings**
- ±15 V Analog Signal Range**
- Low On Resistance (<24 Ω)**
- Ultralow Power Dissipation (3.9 μW)**
- Low Leakage (<0.25 nA)**
- Fast Switching Times**
 - t_{ON} <165 ns**
 - t_{OFF} <130 ns**
- Break-Before-Make Switching Action**
- TTL/CMOS Compatible**
- Plug-in Replacement for DG411/DG412/DG413**

APPLICATIONS

- Audio and Video Switching**
- Automatic Test Equipment**
- Precision Data Acquisition**
- Battery Powered Systems**
- Sample Hold Systems**
- Communication Systems**

GENERAL DESCRIPTION

The ADG431, ADG432 and ADG433 are monolithic CMOS devices comprising four independently selectable switches. They are designed on an enhanced LC²MOS process which provides low power dissipation yet gives high switching speed and low on resistance.

The on resistance profile is very flat over the full analog input range ensuring excellent linearity and low distortion when switching audio signals. Fast switching speed coupled with high signal bandwidth also make the parts suitable for video signal switching. CMOS construction ensures ultralow power dissipation making the parts ideally suited for portable and battery powered instruments.

The ADG431, ADG432 and ADG433 contain four independent SPST switches. The ADG431 and ADG432 differ only in that the digital control logic is inverted. The ADG431 switches are turned on with a logic low on the appropriate control input, while a logic high is required for the ADG432. The ADG433 has two switches with digital control logic similar to that of the ADG431 while the logic is inverted on the other two switches.

Each switch conducts equally well in both directions when ON and has an input signal range which extends to the supplies. In the OFF condition, signal levels up to the supplies are blocked. All switches exhibit break before make switching action for use in multiplexer applications. Inherent in the design is low charge injection for minimum transients when switching the digital inputs.

REV. C

Information furnished by Analog Devices is believed to be accurate and reliable. However, no responsibility is assumed by Analog Devices for its use, nor for any infringements of patents or other rights of third parties which may result from its use. No license is granted by implication or otherwise under any patent or patent rights of Analog Devices.

FUNCTIONAL BLOCK DIAGRAMS

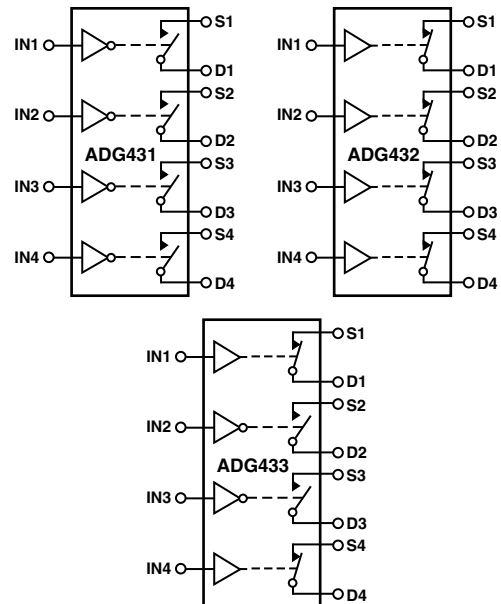

SWITCHES SHOWN FOR A LOGIC "1" INPUT

PRODUCT HIGHLIGHTS

1. **Extended Signal Range**
The ADG431, ADG432 and ADG433 are fabricated on an enhanced LC²MOS process giving an increased signal range which extends fully to the supply rails.
2. **Ultralow Power Dissipation**
3. **Low R_{ON}**
4. **Break-Before-Make Switching**
This prevents channel shorting when the switches are configured as a multiplexer.
5. **Single Supply Operation**
For applications where the analog signal is unipolar, the ADG431, ADG432, and ADG433 can be operated from a single rail power supply. The parts are fully specified with a single 12 V power supply and will remain functional with single supplies as low as 5 V.

ADG431/ADG432/ADG433—SPECIFICATIONS¹

Dual Supply ($V_{DD} = +15\text{ V} \pm 10\%$, $V_{SS} = -15\text{ V} \pm 10\%$, $V_L = +5\text{ V} \pm 10\%$, $GND = 0\text{ V}$, unless otherwise noted.)

Parameter	B Version		Unit	Test Conditions/Comments	
	+25°C	-40°C to +85°C			
ANALOG SWITCH					
Analogue Signal Range		V_{DD} to V_{SS}	V	$V_D = \pm 8.5\text{ V}$, $I_S = -10\text{ mA}$; $V_{DD} = +13.5\text{ V}$, $V_{SS} = -13.5\text{ V}$	
R_{ON}	17		Ω typ		
	24	26	Ω max		
R_{ON} vs. V_D (V_S)	15		% typ		
R_{ON} Drift	0.5		%/°C typ		
R_{ON} Match	5		% typ	$V_D = 0\text{ V}$, $I_S = -10\text{ mA}$	
LEAKAGE CURRENTS					
Source OFF Leakage I_S (OFF)	± 0.05		nA typ	$V_{DD} = +16.5\text{ V}$, $V_{SS} = -16.5\text{ V}$ $V_D = \pm 15.5\text{ V}$, $V_S = \mp 15.5\text{ V}$; Test Circuit 2	
	± 0.25	± 2	nA max		
Drain OFF Leakage I_D (OFF)	± 0.05		nA typ		
	± 0.25	± 2	nA max		
Channel ON Leakage I_D , I_S (ON)	± 0.1		nA typ		$V_D = V_S = \pm 15.5\text{ V}$; Test Circuit 3
	± 0.35	± 3	nA max		
DIGITAL INPUTS					
Input High Voltage, V_{INH}		2.4	V min	$V_{IN} = V_{INL}$ or V_{INH}	
Input Low Voltage, V_{INL}		0.8	V max		
Input Current					
I_{INL} or I_{INH}	0.005		μA typ		
		± 0.02	μA max		
C_{IN} Digital Input Capacitance	9		pF typ		
DYNAMIC CHARACTERISTICS¹					
t_{ON}	90		ns typ	$V_{DD} = +15\text{ V}$, $V_{SS} = -15\text{ V}$ $R_L = 300\ \Omega$, $C_L = 35\text{ pF}$; $V_S = \pm 10\text{ V}$; Test Circuit 4	
		165	ns max		
t_{OFF}	60		ns typ		
		130	ns max		
Break-Before-Make Time Delay, t_D (ADG433 Only)	25		ns typ		$V_S = \pm 10\text{ V}$; Test Circuit 4 $R_L = 300\ \Omega$, $C_L = 35\text{ pF}$; $V_{S1} = V_{S2} = +10\text{ V}$; Test Circuit 5
Charge Injection	5		pC typ		$V_S = 0\text{ V}$, $R_S = 0\ \Omega$, $C_L = 10\text{ nF}$; Test Circuit 6
OFF Isolation	68		dB typ		$R_L = 50\ \Omega$, $C_L = 5\text{ pF}$, $f = 1\text{ MHz}$; Test Circuit 7
Channel-to-Channel Crosstalk	85		dB typ		$R_L = 50\ \Omega$, $C_L = 5\text{ pF}$, $f = 1\text{ MHz}$; Test Circuit 8
C_S (OFF)	9		pF typ		$f = 1\text{ MHz}$
C_D (OFF)	9		pF typ		$f = 1\text{ MHz}$
C_D , C_S (ON)	35		pF typ	$f = 1\text{ MHz}$	
POWER REQUIREMENTS					
I_{DD}	0.0001		μA typ	$V_{DD} = +16.5\text{ V}$, $V_{SS} = -16.5\text{ V}$ Digital Inputs = 0 V or 5 V	
	0.1	0.2	μA max		
I_{SS}	0.0001		μA typ		
	0.1	0.2	μA max		
I_L	0.0001		μA typ		
	0.1	0.2	μA max		
Power Dissipation		7.7	μW max		

NOTES

¹Guaranteed by design, not subject to production test.

Specifications subject to change without notice.

Single Supply ($V_{DD} = 12\text{ V} \pm 10\%$, $V_{SS} = 0\text{ V}$, $V_L = 5\text{ V} \pm 10\%$, $GND = 0\text{ V}$, unless otherwise noted)

Parameter	B Version		Unit	Test Conditions/Comments
	+25°C	-40°C to +85°C		
ANALOG SWITCH				
Analog Signal Range		0 V to V_{DD}	V	
R_{ON}	28		Ω typ	$0 < V_D < 8.5\text{ V}$, $I_S = -10\text{ mA}$; $V_{DD} = 10.8\text{ V}$
	42	45	Ω max	
R_{ON} vs. V_D (V_S)	20		% typ	
R_{ON} Drift	0.5		%/°C typ	
R_{ON} Match	5		% typ	$V_D = 0\text{ V}$, $I_S = -10\text{ mA}$
LEAKAGE CURRENTS				
Source OFF Leakage I_S (OFF)	± 0.04		nA typ	$V_{DD} = 13.2\text{ V}$ $V_D = 12.2/1\text{ V}$, $V_S = 1/12.2\text{ V}$; Test Circuit 2
	± 0.25	± 2	nA max	
Drain OFF Leakage I_D (OFF)	± 0.04		nA typ	$V_D = 12.2/1\text{ V}$, $V_S = 1/12.2\text{ V}$; Test Circuit 2
	± 0.25	± 2	nA max	
Channel ON Leakage I_D , I_S (ON)	± 0.01		nA typ	$V_D = V_S = 12.2\text{ V}/1\text{ V}$; Test Circuit 3
	± 0.3	± 3	nA max	
DIGITAL INPUTS				
Input High Voltage, V_{INH}		2.4	V min	
Input Low Voltage, V_{INL}		0.8	V max	
Input Current				$V_{IN} = V_{INL}$ or V_{INH}
I_{INL} or I_{INH}	0.005		μA typ	
		± 0.01	μA max	
C_{IN} Digital Input Capacitance	9		pF typ	
DYNAMIC CHARACTERISTICS¹				
t_{ON}	165		ns typ	$V_{DD} = 12\text{ V}$, $V_{SS} = 0\text{ V}$ $R_L = 300\ \Omega$, $C_L = 35\text{ pF}$; $V_S = 8\text{ V}$; Test Circuit 4
		240	ns max	
t_{OFF}	60		ns typ	$R_L = 300\ \Omega$, $C_L = 35\text{ pF}$; $V_S = 8\text{ V}$; Test Circuit 4
		115	ns max	
Break-Before-Make Time Delay, t_D (ADG433 Only)	25		ns typ	$R_L = 300\ \Omega$, $C_L = 35\text{ pF}$; $V_{S1} = V_{S2} = 10\text{ V}$; Test Circuit 5
Charge Injection	25		pC typ	$V_S = 0\text{ V}$, $R_S = 0\ \Omega$, $C_L = 10\text{ nF}$; Test Circuit 6
OFF Isolation	68		dB typ	$R_L = 50\ \Omega$, $C_L = 5\text{ pF}$, $f = 1\text{ MHz}$; Test Circuit 7
Channel-to-Channel Crosstalk	85		dB typ	$R_L = 50\ \Omega$, $C_L = 5\text{ pF}$, $f = 1\text{ MHz}$; Test Circuit 8
C_S (OFF)	9		pF typ	$f = 1\text{ MHz}$
C_D (OFF)	9		pF typ	$f = 1\text{ MHz}$
C_D , C_S (ON)	35		pF typ	$f = 1\text{ MHz}$
POWER REQUIREMENTS				
I_{DD}	0.0001		μA typ	$V_{DD} = 13.2\text{ V}$ Digital Inputs = 0 V or 5 V
	0.03	0.1	μA max	
I_L	0.0001		μA typ	$V_L = 5.25\text{ V}$
	0.03	0.1	μA max	
Power Dissipation		1.9	μW max	

NOTES

¹Guaranteed by design, not subject to production test.

Specifications subject to change without notice.

Truth Table (ADG431/ADG432)

ADG431 In	ADG432 In	Switch Condition
0	1	ON
1	0	OFF

Truth Table (ADG433)

Logic	Switch 1, 4	Switch 2, 3
0	OFF	ON
1	ON	OFF

ADG431/ADG432/ADG433

ABSOLUTE MAXIMUM RATINGS

(T_A = 25°C unless otherwise noted.)

V _{DD} to V _{SS}	44 V
V _{DD} to GND	-0.3 V to +25 V
V _{SS} to GND	+0.3 V to -25 V
V _L to GND	-0.3 V to V _{DD} + 0.3 V
Analog, Digital Inputs ²	V _{SS} - 2 V to V _{DD} + 2 V or 30 mA, Whichever Occurs First
Continuous Current, S or D	30 mA
Peak Current, S or D (Pulsed at 1 ms, 10% Duty Cycle max)	100 mA
Operating Temperature Range	
Industrial (B Version)	-40°C to +85°C
Storage Temperature Range	-65°C to +150°C
Junction Temperature	150°C

Plastic Package, Power Dissipation	470 mW
θ _{JA} , Thermal Impedance	117°C/W
Lead Temperature, Soldering (10 sec)	260°C
SOIC Package, Power Dissipation	600 mW
θ _{JA} , Thermal Impedance	77°C/W
Lead Temperature, Soldering	
Vapor Phase (60 sec)	215°C
Infrared (15 sec)	220°C

NOTES

¹Stresses above those listed under Absolute Maximum Ratings may cause permanent damage to the device. This is a stress rating only; functional operation of the device at these or any other conditions above those listed in the operational sections of this specification is not implied. Exposure to absolute maximum rating conditions for extended periods may affect device reliability. Only one absolute maximum rating may be applied at any one time.

²Overvoltages at IN, S or D will be clamped by internal diodes. Current should be limited to the maximum ratings given.

CAUTION

ESD (electrostatic discharge) sensitive device. Electrostatic charges as high as 4000 V readily accumulate on the human body and test equipment and can discharge without detection. Although the ADG431/ADG432/ADG433 features proprietary ESD protection circuitry, permanent damage may occur on devices subjected to high-energy electrostatic discharges. Therefore, proper ESD precautions are recommended to avoid performance degradation or loss of functionality.



PIN CONFIGURATION (DIP/SOIC)



ORDERING GUIDE

Model	Temperature Range	Package Option ¹
ADG431BN	-40°C to +85°C	N-16
ADG431BR	-40°C to +85°C	R-16A
ADG431ABR	-40°C to +85°C	R-16A ²
ADG432BN	-40°C to +85°C	N-16
ADG432BR	-40°C to +85°C	R-16A
ADG432ABR	-40°C to +85°C	R-16A ²
ADG433BN	-40°C to +85°C	N-16
ADG433BR	-40°C to +85°C	R-16A
ADG433ABR	-40°C to +85°C	R-16A ²

NOTES

¹N = Plastic DIP; R = 0.15" Small Outline IC (SOIC).

²Trench isolated, latch-up proof parts. See Trench Isolation section.

TERMINOLOGY

V _{DD}	Most positive power supply potential.
V _{SS}	Most negative power supply potential in dual supplies. In single supply applications, it may be connected to GND.
V _L	Logic power supply (5 V).
GND	Ground (0 V) reference.
S	Source terminal. May be an input or output.
D	Drain terminal. May be an input or output.
IN	Logic control input.
R _{ON}	Ohmic resistance between D and S.
R _{ON} vs. V _D (V _S)	The variation in R _{ON} due to a change in the analog input voltage with a constant load current.
R _{ON} Drift	Change in R _{ON} vs. temperature.
R _{ON} Match	Difference between the R _{ON} of any two switches.
I _S (OFF)	Source leakage current with the switch "OFF."
I _D (OFF)	Drain leakage current with the switch "OFF."
I _D , I _S (ON)	Channel leakage current with the switch "ON."
V _D (V _S)	Analog voltage on terminals D, S.

C _S (OFF)	"OFF" switch source capacitance.
C _D (OFF)	"OFF" switch drain capacitance.
C _D , C _S (ON)	"ON" switch capacitance.
C _{IN}	Input Capacitance to ground of a digital input.
t _{ON}	Delay between applying the digital control input and the output switching on.
t _{OFF}	Delay between applying the digital control input and the output switching off.
t _D	"OFF" time or "ON" time measured between the 90% points of both switches, when switching from one address state to another.
Crosstalk	A measure of unwanted signal which is coupled through from one channel to another as a result of parasitic capacitance.
Off Isolation	A measure of unwanted signal coupling through an "OFF" switch.
Charge Injection	A measure of the glitch impulse transferred from the digital input to the analog output during switching.

Typical Performance Characteristics—ADG431/ADG432/ADG433



TPC 1. On Resistance as a Function of V_D (V_S) Dual Supplies



TPC 4. On Resistance as a Function of V_D (V_S) Single Supply



TPC 2. On Resistance as a Function of V_D (V_S) for Different Temperatures



TPC 5. Supply Current vs. Input Switching Frequency



TPC 3. Leakage Currents as a Function of Temperature

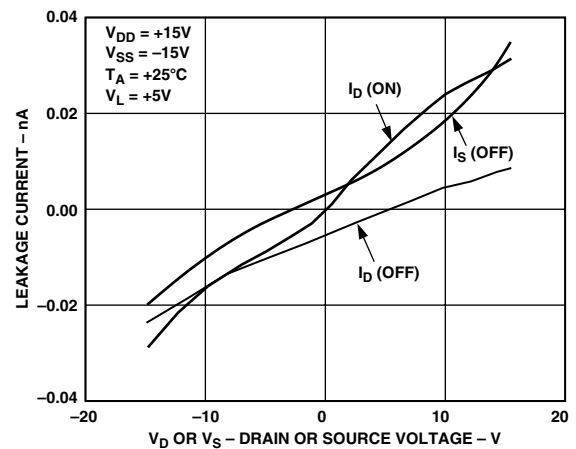

TPC 6. Leakage Currents as a Function of V_D (V_S)

ADG431/ADG432/ADG433



TPC 7. Off Isolation vs. Frequency



TPC 8. Crosstalk vs. Frequency

TRENCH ISOLATION

In the ADG431A, ADG432A and ADG433A, an insulating oxide layer (trench) is placed between the NMOS and PMOS transistors of each CMOS switch. Parasitic junctions, which occur between the transistors in junction isolated switches, are eliminated, the result being a completely latch-up proof switch.

In junction isolation, the N and P wells of the PMOS and NMOS transistors form a diode that is reverse-biased under normal operation. However, during overvoltage conditions, this diode becomes forward biased. A silicon-controlled rectifier (SCR) type circuit is formed by the two transistors causing a significant amplification of the current which, in turn, leads to latch up. With trench isolation, this diode is removed, the result being a latch-up proof switch.

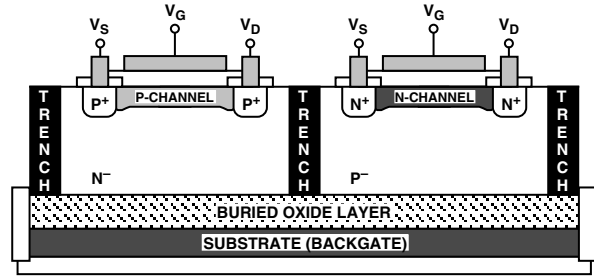

Figure 1. Trench Isolation

APPLICATION

Figure 2 illustrates a precise, fast sample-and-hold circuit. An AD845 is used as the input buffer while the output operational amplifier is an AD711. During the track mode, SW1 is closed and the output V_{OUT} follows the input signal V_{IN} . In the hold mode, SW1 is opened and the signal is held by the hold capacitor C_H .

Due to switch and capacitor leakage, the voltage on the hold capacitor will decrease with time. The ADG431/ADG432/ADG433 minimizes this droop due to its low leakage specifications. The droop rate is further minimized by the use of a polystyrene hold capacitor. The droop rate for the circuit shown is typically $30 \mu\text{V}/\mu\text{s}$.

A second switch SW2, which operates in parallel with SW1, is included in this circuit to reduce pedestal error. Since both switches will be at the same potential, they will have a differential effect on the op amp AD711 which will minimize charge injection effects. Pedestal error is also reduced by the compensation network R_C and C_C . This compensation network also reduces the hold time glitch while optimizing the acquisition time. Using the illustrated op amps and component values, the pedestal error has a maximum value of 5 mV over the $\pm 10 \text{ V}$ input range. Both the acquisition and settling times are 850 ns.

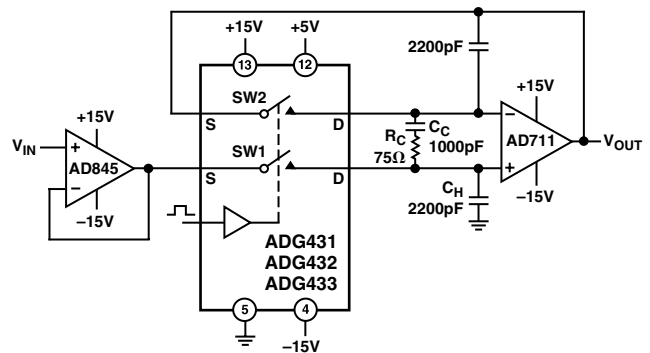
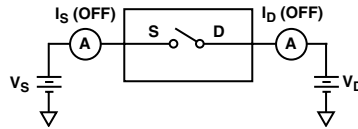

Figure 2. Fast, Accurate Sample-and-Hold

Test Circuits



Test Circuit 1. On Resistance



Test Circuit 2. Off Leakage

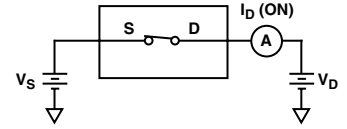

Test Circuit 3. On Leakage

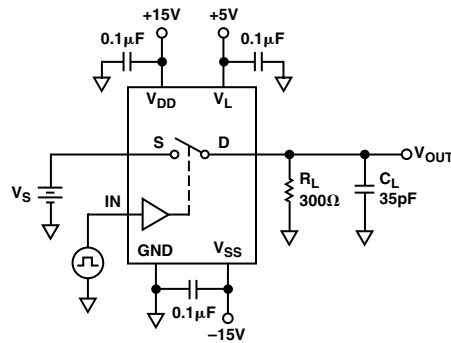

Test Circuit 4. Switching Times

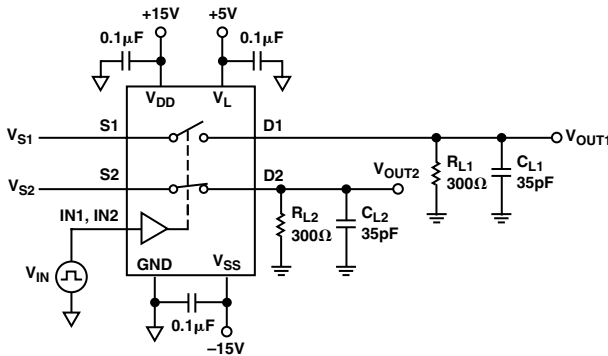
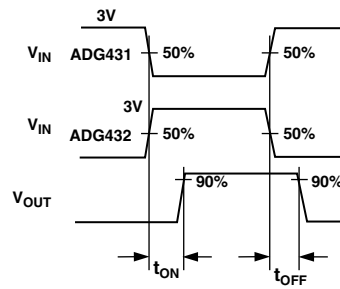

Test Circuit 5. Break-Before-Make Time Delay

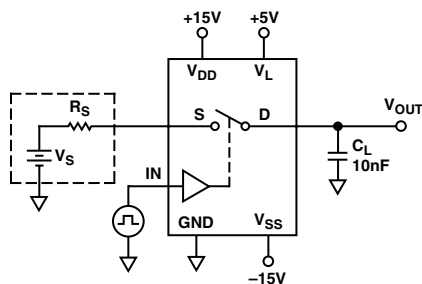
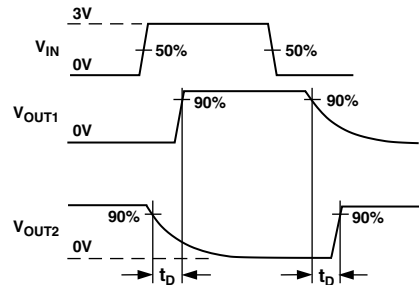

Test Circuit 6. Charge Injection

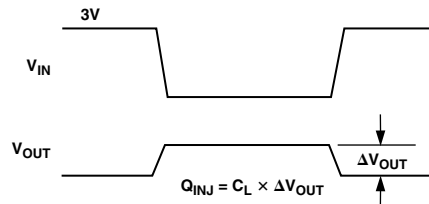

ADG431/ADG432/ADG433



Test Circuit 7. Off Isolation



Test Circuit 8. Channel-to-Channel Crosstalk

OUTLINE DIMENSIONS

Dimensions shown in inches and (mm).

16-Lead Plastic DIP (Narrow)

(N-16)

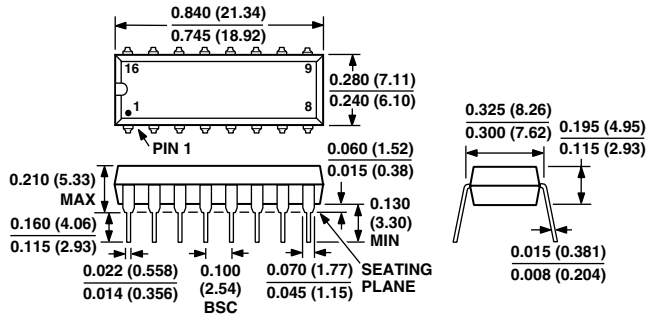

16-Lead SOIC

(R-16A)

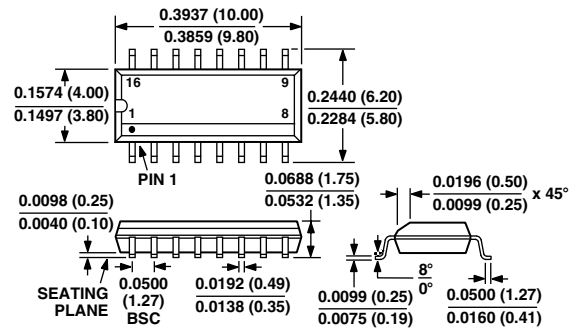

ADG431/ADG432/ADG433—Revision History

Location

Location	Page
Data Sheet changed from REV. B to REV. C.	
Changes to Specifications Table (Dual Supply)	2
Changes to Specifications Table (Single Supply)	3
Changes to Absolute Maximum Ratings	4
Changes to Ordering Guide	4
16-Lead Cerdip deleted from Outline Dimensions	8



Компания «ЭлектроПласт» предлагает заключение долгосрочных отношений при поставках импортных электронных компонентов на взаимовыгодных условиях!

Наши преимущества:

- Оперативные поставки широкого спектра электронных компонентов отечественного и импортного производства напрямую от производителей и с крупнейших мировых складов;
- Поставка более 17-ти миллионов наименований электронных компонентов;
- Поставка сложных, дефицитных, либо снятых с производства позиций;
- Оперативные сроки поставки под заказ (от 5 рабочих дней);
- Экспресс доставка в любую точку России;
- Техническая поддержка проекта, помощь в подборе аналогов, поставка прототипов;
- Система менеджмента качества сертифицирована по Международному стандарту ISO 9001;
- Лицензия ФСБ на осуществление работ с использованием сведений, составляющих государственную тайну;
- Поставка специализированных компонентов (Xilinx, Altera, Analog Devices, Intersil, Interpoint, Microsemi, Aeroflex, Peregrine, Syfer, Eurofarad, Texas Instrument, Miteq, Cobham, E2V, MA-COM, Hittite, Mini-Circuits, General Dynamics и др.);

Помимо этого, одним из направлений компании «ЭлектроПласт» является направление «Источники питания». Мы предлагаем Вам помощь Конструкторского отдела:

- Подбор оптимального решения, техническое обоснование при выборе компонента;
- Подбор аналогов;
- Консультации по применению компонента;
- Поставка образцов и прототипов;
- Техническая поддержка проекта;
- Защита от снятия компонента с производства.



Как с нами связаться

Телефон: 8 (812) 309 58 32 (многоканальный)

Факс: 8 (812) 320-02-42

Электронная почта: org@eplast1.ru

Адрес: 198099, г. Санкт-Петербург, ул. Калинина, дом 2, корпус 4, литера А.