

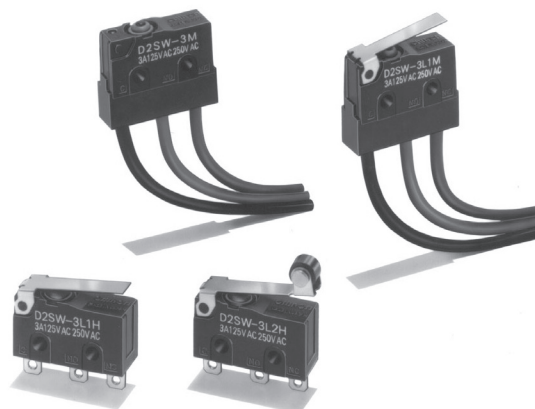



Sealed Snap Action Switch D2SW

Watertight Miniature Snap Action Switch

- High-quality watertight miniature Snap Action switch. Switch Body meets IP67 (IEC 529) requirements
- Monoblock construction assures high sealing capability and is ideal for dusty places or where water is sprayed
- Wide operating temperature range of -40°C to 85°C
- Perfect for the automobile, agriculture machinery, automatic vending machine, refrigerator, ice-manufacturing, hot-water supply, air conditioner, and industrial equipment, which require highly environment-resistive capabilities
- RoHS Compliant



Ordering Information

Actuator	Terminal	Model	
		Model 3 A	Model 0.1 A
Pin plunger 	Solder terminals	D2SW-3HS	D2SW-01HS
	Quick-connect terminals (#110)	D2SW-3TS	D2SW-01TS
	PCB terminals	D2SW-3DS	D2SW-01DS
	With lead wires	D2SW-3MS	D2SW-01MS
Hinge lever 	Solder terminals	D2SW-3L1HS	D2SW-01L1HS
	Quick-connect terminals (#110)	D2SW-3L1TS	D2SW-01L1TS
	PCB terminals	D2SW-3L1DS	D2SW-01L1DS
	With lead wires	D2SW-3L1MS	D2SW-01L1MS
Simulated roller lever 	Solder terminals	D2SW-3L3HS	D2SW-01L3HS
	Quick-connect terminals (#110)	D2SW-3L3TS	D2SW-01L3TS
	PCB terminals	D2SW-3L3DS	D2SW-01L3DS
	With lead wires	D2SW-3L3MS	D2SW-01L3MS
Hinge roller lever 	Solder terminals	D2SW-3L2HS	D2SW-01L2HS
	Quick-connect terminals (#110)	D2SW-3L2TS	D2SW-01L2TS
	PCB terminals	D2SW-3L2DS	D2SW-01L2DS
	With lead wires	D2SW-3L2MS	D2SW-01L2MS

Note: 1. "S" at the end of the part number signifies UL/CSA approved models.

2. The standard lengths of the lead wires (UL1015 AWG22 for UL/CSA models, AV0.5f otherwise.) of models incorporating them are 30 cm.

Model Number Legend

D2SW-□□□□
1 2 3 4

1. Ratings

- 3: 3 A at 125 VAC
- 01: 0.1 A at 30 VDC

2. Actuator

- None: Pin plunger
- L1: Hinge lever
- L2: Hinge roller lever
- L3: Simulated roller lever

3. Contact Form

- None: SPDT
- 2: SPST-NC*
- 3: SPST-NO*

*Lead wire versions only

4. Terminals

- H, HS: Solder terminals (HS for UL and CSA approval)
- D, DS: PCB terminals (DS for UL and CSA approval)
- T, TS: Quick-connect terminals (#110) (TS for UL and CSA approval)
- M, MS: Molded lead wires (MS for UL and CSA approval)

Specifications

■ Characteristics

Item	D2SW-3		D2SW-01	
Operating speed	0.1 mm to 1 m/second (at pin plunger)			
Operating frequency	Mechanical: 300 operations/minute max. Electrical: 30 operations/minute max.			
Insulation resistance	100 MΩ min. (at 500 VDC)			
Contact resistance	30 mΩ max. for terminal models		50 mΩ max. for terminal models	
	50 mΩ max. for lead wire models		70 mΩ max. for lead wire models	
Dielectric strength (See note 2)	1,000 VAC, 50/60 Hz for 1 min. between terminals of the same polarity		600 VAC, 50/60 Hz for 1 min. between terminals of the same polarity	
	1,500 VAC, 50/60 Hz for 1 min. between current-carrying metal parts and ground, and between each terminal and noncurrent-carrying metal parts			
Vibration resistance (See note 3)	Malfunction: 10 to 55 Hz, 1.5 mm double amplitude			
Shock resistance (See note 3)	Destruction: 1,000 m/s ² (approx. 100G) max.			
	Malfunction: 300 m/s ² (approx. 30G) max.			
Ambient operating temperature	-40° to 85°C (at 60% RH) with no icing			
Ambient operating humidity	95% max. (for 5°C to 35°C)			
Degree of protection	IEC IP67 (excluding the terminals on terminal models)			
Degree of protection against electric shock	Class I			
Proof tracking index (PTI)	175			
Life expectancy	Mechanical	5,000,000 operations min. at 60 operations per minute		
	Electrical (30 operations per minute)	200,000 operations min. (3 A at 125 VAC) 100,000 operations min. (2 A at 250 VAC)	200,000 operations min. (at rated resistive load)	
Weight	Terminal model	Approx. 2 g		
	Lead wire model	Approx. 10 g		

- Note: 1. Data shown are of initial value.
 2. The dielectric strength shown is measured using a separator between the switch and metal mounting plate
 3. For pin plunger models, the above values apply for use at the free position, operating position, and total travel position. For models with levers, the values apply at the total travel position.

■ Ratings (reference values)

D2SW-3

Rated Voltage	Non-inductive load (A)				Inductive load			
	Resistive load		Lamp load		Inductive load		Motor load	
	NC	NO	NC	NO	NC	NO	NC	NO
125 VAC	3 A		1 A	0.5 A	1 A	0.5 A	1 A	0.5 A
250 VAC	2 A		0.5 A	0.3 A	0.5 A	0.3 A	0.5 A	0.3 A
30 VDC	3 A		1 A		1 A		1 A	

D2SW-01

Rated Voltage	Non-inductive load				Inductive load			
	Resistive load		Lamp load		Inductive load		Motor load	
	NC	NO	NC	NO	NC	NO	NC	NO
125 VAC	0.1 A		—		—		—	
30 VDC	0.1 A		—		—		—	

- Note: 1. The resistive load ratings apply under the following test conditions:
 Ambient Temperature = 20±2°C, Ambient Humidity = 65±5%, Operating frequency = 30 operations/min.
 2. The above current ratings are the values of the steady-state current.
 3. Inductive load has a power factor of 0.7 min. (AC) and a time constant of 7 ms max. (DC).
 4. Lamp load has an inrush current of 10 times the steady-state current.
 5. Motor load has an inrush current of 6 times the steady-state current.

■ Approvals

Consult your OMRON sales representative for specific models with standard approvals.

UL Recognized, CSA Certified

Rated Voltage	D2SW-3	D2SW-01
125 VAC	3 A	0.1 A
250 VAC	2 A	- - -
30 VDC	3 A	0.1 A

EN 61058-1 (VDE Approval)

Rated Voltage	D2SW-01
125 VAC	0.1 A

Testing conditions: 5E4 (50,000 operations), T85 (0°C to 85°C)

■ Contact Specifications

Item	D2SW-3	D2SW-01
Specification	Rivet	Crossbar
Material	Silver	Gold alloy
Gap (standard value)	0.5 mm	
Inrush current	NC: 20 A max. NO: 10 A max.	1 A max.
Minimum applicable load (see note)	160 mA at 5 VDC	1 mA at 5 VDC

Note: Minimum applicable loads are indicated by N standard reference values. This value represents the failure rate at a 60% (λ_{60}) reliability level (JIS C5003).
The equation $\lambda_{60} = 0.5 \times 10^{-6} / \text{operations}$ indicates that a failure rate of 1/2,000,000 operations can be expected at a reliability level of 60%

Engineering data

■ Mounting

All switches may be panel mounted using M2.3 mounting screws with plane washers or spring washers to securely mount the switch. Tighten the screws to a torque of 0.23 to 0.26 N·m.

Panel Mounting

Two, 2.4-dia. mounting hole or M2.3 screw hole

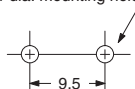

■ PCB Layout (reference)

PCB Mounting

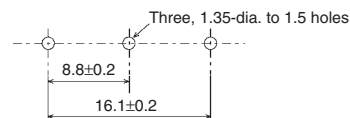

■ Structure

SPDT

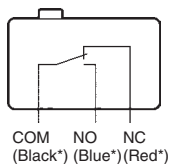

SPST-NC

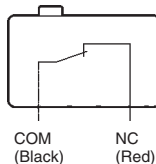

SPST-NO

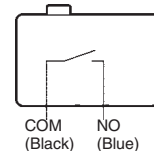

*Indicates the color of the lead wire.

Dimensions

■ Terminals

Note: Unless otherwise specified, all units are in millimeters and a tolerance of ± 0.4 mm applies to all dimensions

Solder Terminals (HS)

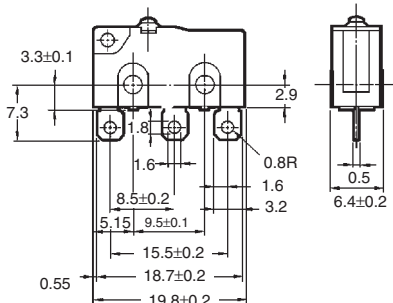

Quick-connect Terminals (#110) (TS)

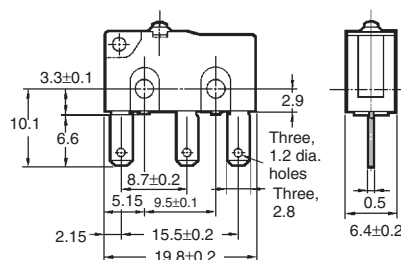

PCB Terminals (DS)

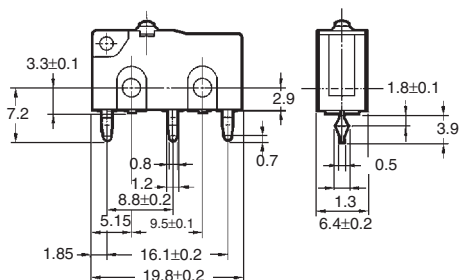

Molded Lead Wires

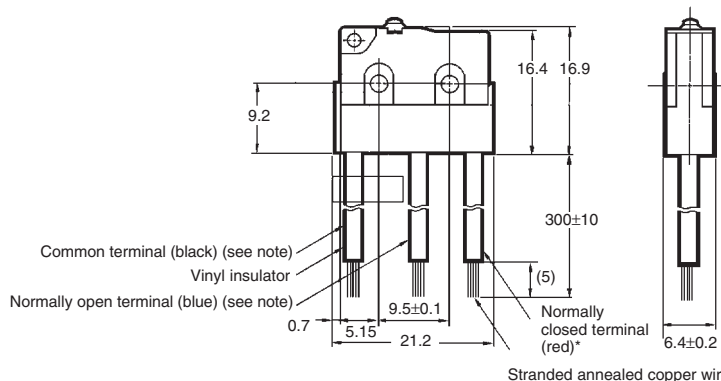

Stranded annealed copper wires

* UL/CSA approved models have UL approved AWG22 wiring.

■ Dimensions and Operating Characteristics

- Note:** 1. Unless otherwise specified, all units are in millimeters and a tolerance of ± 0.4 mm applies to all dimensions
 2. Omitted dimensions are the same as pin plunger type.
 3. The following illustrations and dimensions are for models with solder terminals. Refer to "Terminals" for models with quick-connect (#110) and PCB terminals.
 4. The operating characteristics are for operation in the A direction(▼)

Pin Plunger Models

D2SW-3□S
 D2SW-01□S

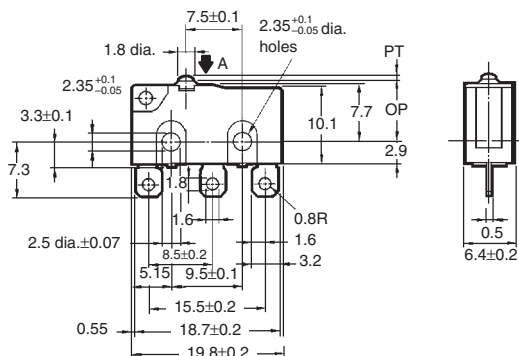
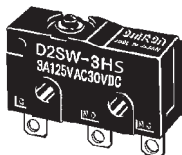

OF	180 gf
RF min.	30 gf
PT max.	0.6 mm
OT min.	0.5 mm
MD max.	0.1 mm
OP	8.4 ± 0.3 mm

Hinge Lever Models

D2SW-3L1□S
 D2SW-01L1□S

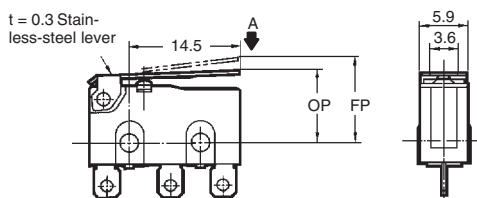
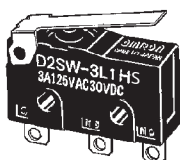

OF	60 gf
RF min.	6 gf
OT min.	1.0 mm
MD max.	0.8 mm
FP max.	13.6 mm
OP	8.8 ± 0.8 mm

Simulated Roller Lever Models

D2SW-3L3□S
 D2SW-01L3□S

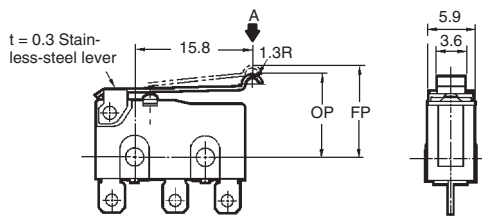
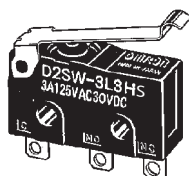

OF	60 gf
RF min.	6 gf
OT min.	1.0 mm
MD max.	0.8 mm
FP max.	15.5 mm
OP	10.7 ± 0.8 mm

Hinge Roller Lever Models

D2SW-3L2□S
 D2SW-01L2□S

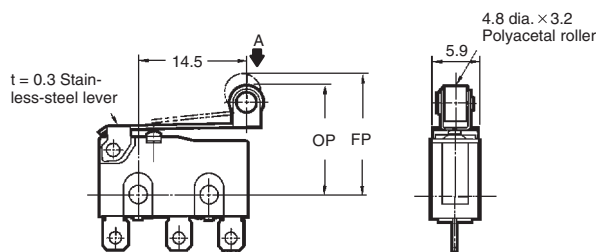
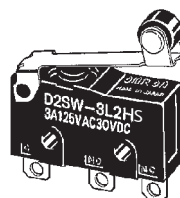

OF	60 gf
RF min.	6 gf
OT min.	1.0 mm
MD max.	0.8 mm
FP max.	19.3 mm
OP	14.5 ± 0.8 mm

Precautions

Be sure to read the precautions and information common to all Snap Action and Detection Switches, contained in the Technical User's Guide, "Snap Action Switches, Technical Information" for correct use.

Correct Use

Operation stroke

Make sure that the switching object is perfectly separated from the actuator when the switch is not operated and the actuator is pressed appropriately by the switching object when the switch is operated.

The switch should be set so that its stroke will be within the rated OT when the switch is operated.

Handling

Install the switching object so that its moving direction is the same as that of the actuator. With the pin plunger models, set the switch so that the plunger can be actuated from directly above. Since the plunger is covered with a rubber cap, applying a force from lateral directions may cause damage to the plunger or reduction in the sealing capability.

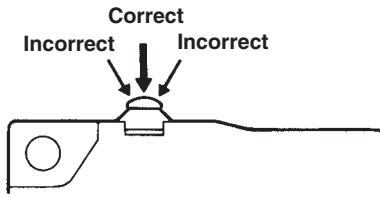

Handle D2SW models with pin plungers with care so that the sealing rubber parts around the pin plungers will not be damaged.

Make sure that there is no icing when using the D2SW at low ambient temperatures.

Using Microloads

Using a model for ordinary loads to switch microloads may result in faulty operation. Instead, use the models that are designed for microloads and that operate in the following range;

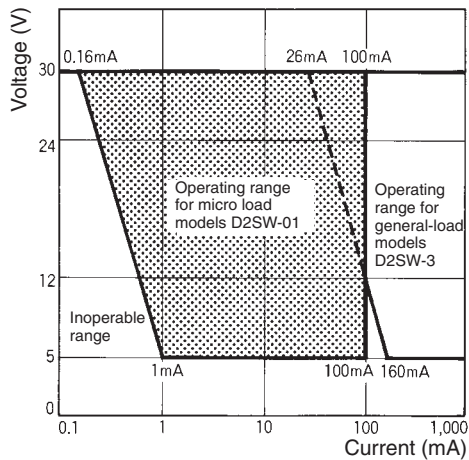

However, even when using microload models within the operating range shown above, if inrush current or inductive voltage spikes occur when the contact is opened or closed, then contact wear may increase and so decrease the service life. Therefore, insert a contact protection circuit where necessary.

Cautions

Degree of Protection

The D2SW was tested under water and passed the following watertightness test, which however, does not mean that the D2SW can be used in the water. JIS C0929 (rules for testing the watertightness of electrical devices and materials), class 7 (watertightness test). Refer to the following illustration for the test method.

IEC Publication 529, class IP67. Refer to the following illustration for the test method.

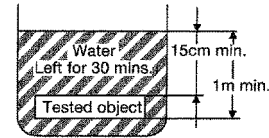

Note: The object to be tested is left in the water for 30 minutes on condition that the distance between the surface of the water and the top of the object be 15 cm minimum, and the distance between the surface of the water and the bottom of the object be 1 m minimum.

Protection Against Chemicals

Prevent the switch from coming into contact with oil and chemicals. Otherwise, damage and deterioration to the switch materials may occur.

Soldering

When soldering a lead wire to a terminal of the D2SW, use a soldering iron with a maximum capacity of 30 W and do not take more than 5 seconds to solder the lead wire, otherwise the characteristics of the D2SW may be altered.

A large grid of 20 columns and 30 rows of small squares, intended for taking notes. The grid is composed of thin lines forming a uniform pattern of squares across the page.

All sales are subject to Omron Electronic Components LLC standard terms and conditions of sale, which can be found at http://www.components.omron.com/components/web/webfiles.nsf/sales_terms.html

ALL DIMENSIONS SHOWN ARE IN MILLIMETERS.
To convert millimeters into inches, multiply by 0.03937. To convert grams into ounces, multiply by 0.03527.

OMRON[®]

**OMRON ELECTRONIC
COMPONENTS LLC**

55 E. Commerce Drive, Suite B
Schaumburg, IL 60173

847-882-2288

OMRON ON-LINE

Global - <http://www.omron.com>

USA - <http://www.components.omron.com>



Компания «ЭлектроПласт» предлагает заключение долгосрочных отношений при поставках импортных электронных компонентов на взаимовыгодных условиях!

Наши преимущества:

- Оперативные поставки широкого спектра электронных компонентов отечественного и импортного производства напрямую от производителей и с крупнейших мировых складов;
- Поставка более 17-ти миллионов наименований электронных компонентов;
- Поставка сложных, дефицитных, либо снятых с производства позиций;
- Оперативные сроки поставки под заказ (от 5 рабочих дней);
- Экспресс доставка в любую точку России;
- Техническая поддержка проекта, помощь в подборе аналогов, поставка прототипов;
- Система менеджмента качества сертифицирована по Международному стандарту ISO 9001;
- Лицензия ФСБ на осуществление работ с использованием сведений, составляющих государственную тайну;
- Поставка специализированных компонентов (Xilinx, Altera, Analog Devices, Intersil, Interpoint, Microsemi, Aeroflex, Peregrine, Syfer, Eurofarad, Texas Instrument, Miteq, Cobham, E2V, MA-COM, Hittite, Mini-Circuits, General Dynamics и др.);

Помимо этого, одним из направлений компании «ЭлектроПласт» является направление «Источники питания». Мы предлагаем Вам помощь Конструкторского отдела:

- Подбор оптимального решения, техническое обоснование при выборе компонента;
- Подбор аналогов;
- Консультации по применению компонента;
- Поставка образцов и прототипов;
- Техническая поддержка проекта;
- Защита от снятия компонента с производства.



Как с нами связаться

Телефон: 8 (812) 309 58 32 (многоканальный)

Факс: 8 (812) 320-02-42

Электронная почта: org@eplast1.ru

Адрес: 198099, г. Санкт-Петербург, ул. Калинина, дом 2, корпус 4, литера А.