

## STRADA-FW

Beam with wide light distribution and good illuminance uniformity for residential street lighting and staggered pole setups. Optimized for CREE XP-G and XP-E LEDs. Assembly with installation tape.

### TECHNICAL SPECIFICATIONS:

Dimensions	19.6 x 15.5 mm
Height	10.8 mm
Fastening	tape, pin, screw
ROHS compliant	yes ⓘ



### MATERIAL SPECIFICATIONS:

Component	Type	Material	Colour	Finish
STRADA-FW	Single lens	PMMA	clear	
VOSU-WU-M-365-TAPE	Tape			

### ORDERING INFORMATION:

Component		Qty in box	MOQ	MPQ	Box weight (kg)
CA12087_STRADA-FW	Single lens	3120	240	240	4.9
» Box size: 451 x 273 x 197 mm					

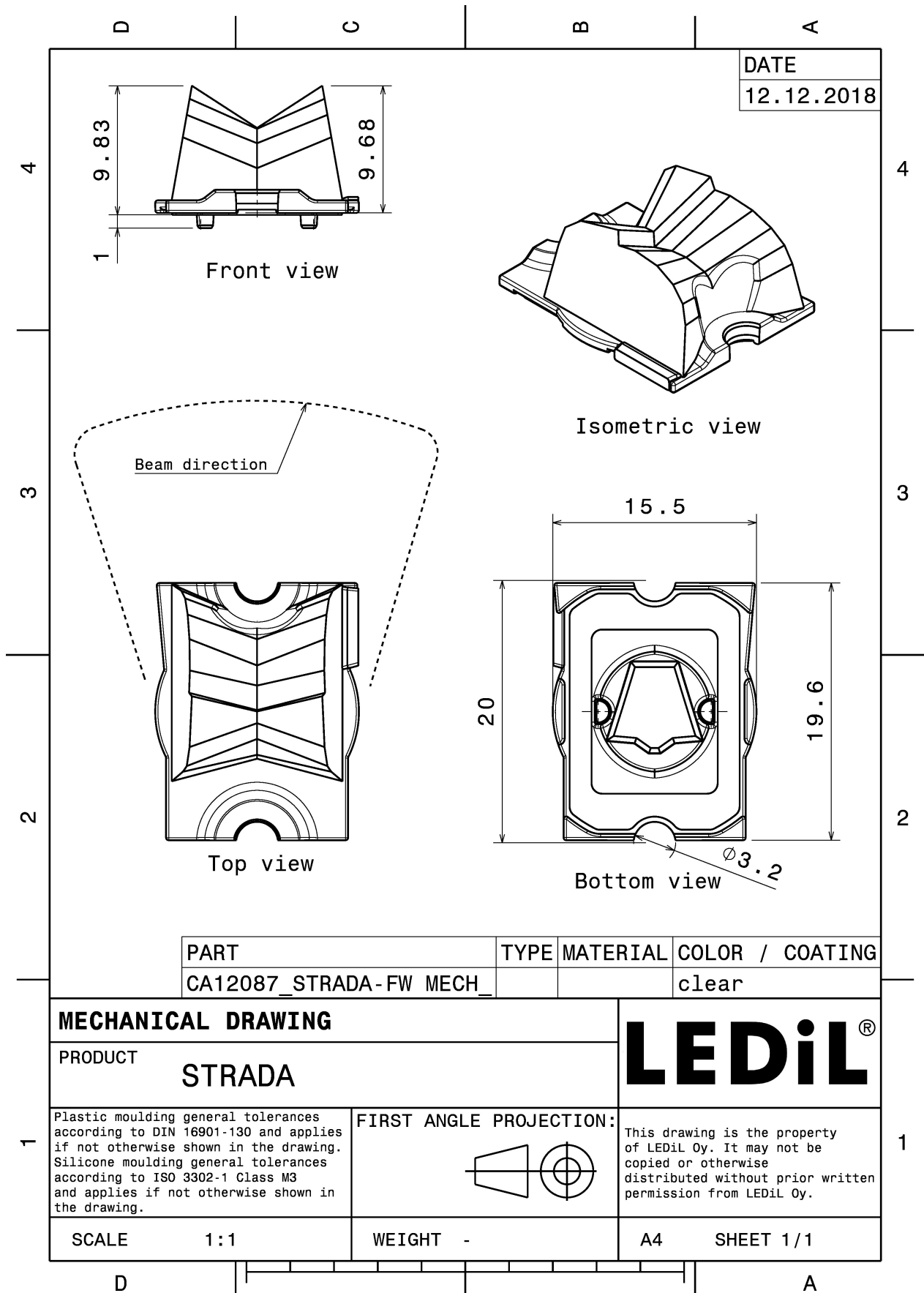

### PHOTOMETRIC DATA (MEASURED):

#### CREE

LED XM-L  
FWHM Asymmetric  
Efficiency 92 %  
LEDs/each optic 1  
Light colour White  
Required components:

#### CREE

LED XM-L2  
FWHM Asymmetric  
Efficiency 94 %  
Peak intensity 0.7 cd/lm  
LEDs/each optic 1  
Light colour White  
Required components:

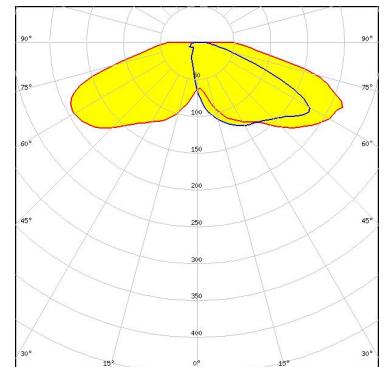

#### CREE

LED XP-E  
FWHM Asymmetric  
Efficiency 92 %  
LEDs/each optic 1  
Light colour White  
Required components:

#### CREE

LED XP-G  
FWHM Asymmetric  
Efficiency 92 %  
LEDs/each optic 1  
Light colour White  
Required components:

### PHOTOMETRIC DATA (MEASURED):

#### CREE

LED XP-G2  
FWHM Asymmetric  
Efficiency 93 %  
Peak intensity 0.9 cd/lm  
LEDs/each optic 1  
Light colour White  
Required components:

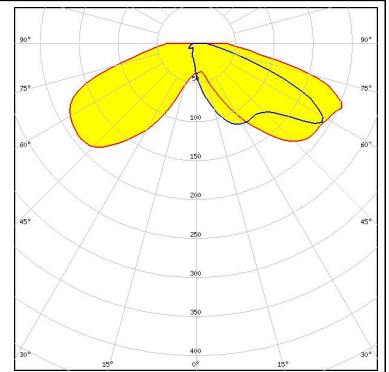

#### CREE

LED XP-L HD  
FWHM Asymmetric  
Efficiency 93 %  
Peak intensity 0.7 cd/lm  
LEDs/each optic 1  
Light colour White  
Required components:

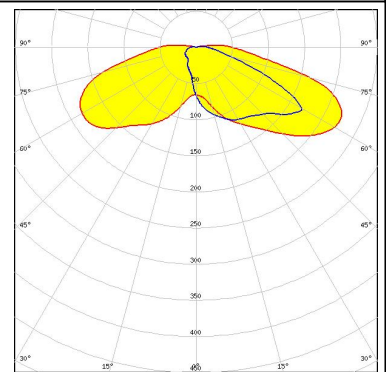

#### CREE

LED XP-L2  
FWHM Asymmetric  
Efficiency 92 %  
Peak intensity 0.6 cd/lm  
LEDs/each optic 1  
Light colour White  
Required components:

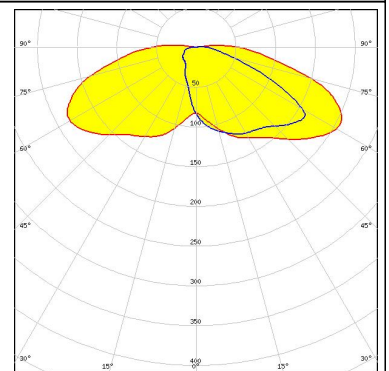

#### CREE

LED XT-E  
FWHM Asymmetric  
Efficiency %  
LEDs/each optic 1  
Light colour White  
Required components:

### PHOTOMETRIC DATA (MEASURED):

#### LG Innotek

LED H35B0 (LEMWA32)  
FWHM Asymmetric  
Efficiency 91 %  
Peak intensity 1 cd/Im  
LEDs/each optic 1  
Light colour White  
Required components:

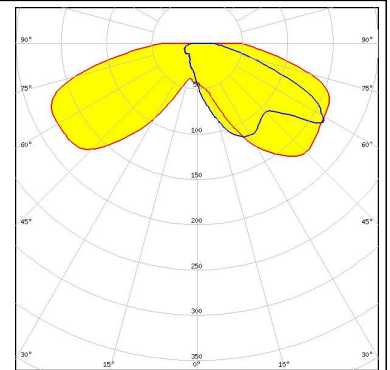

#### LG Innotek

LED H35C0 (LEMWA33)  
FWHM Asymmetric  
Efficiency %  
Peak intensity 0.9 cd/Im  
LEDs/each optic 1  
Light colour White  
Required components:

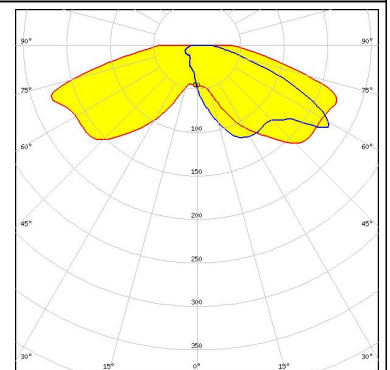

#### LUMILEDS

LED LUXEON Rebel  
FWHM Asymmetric  
Efficiency 92 %  
LEDs/each optic 1  
Light colour White  
Required components:

#### LUMILEDS

LED LUXEON Rebel ES  
FWHM Asymmetric  
Efficiency 92 %  
LEDs/each optic 1  
Light colour White  
Required components:

#### PHOTOMETRIC DATA (MEASURED):

##### LUMILEDS

LED LUXEON T  
 FWHM Asymmetric  
 Efficiency 91 %  
 Peak intensity 0.8 cd/lm  
 LEDs/each optic 1  
 Light colour White  
 Required components:

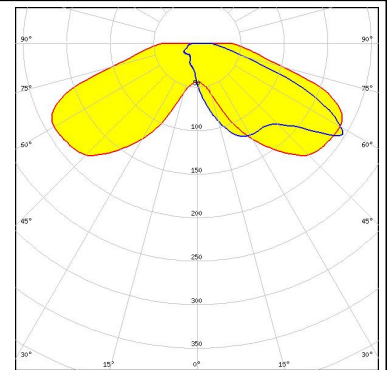

##### LUMILEDS

LED LUXEON TX  
 FWHM Asymmetric  
 Efficiency 93 %  
 Peak intensity 0.8 cd/lm  
 LEDs/each optic 1  
 Light colour White  
 Required components:

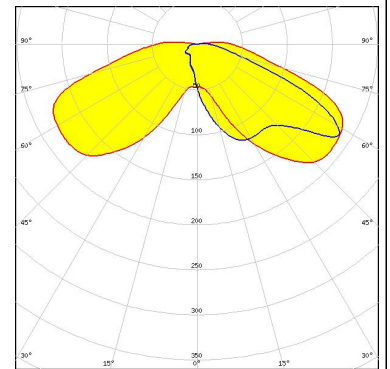

##### LUMILEDS

LED LUXEON Z ES  
 FWHM Asymmetric  
 Efficiency 91 %  
 Peak intensity 1 cd/lm  
 LEDs/each optic 1  
 Light colour White  
 Required components:

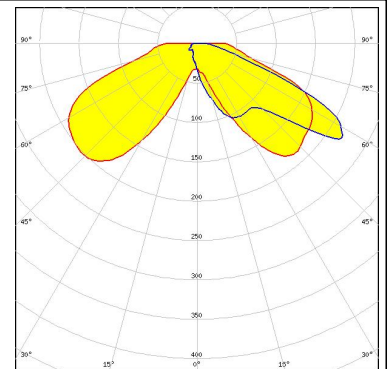

##### NICHIA

LED NCSxx19A  
 FWHM Asymmetric  
 Efficiency 92 %  
 LEDs/each optic 1  
 Light colour White  
 Required components:

### PHOTOMETRIC DATA (MEASURED):



LED NVSW219D  
FWHM Asymmetric  
Efficiency 92 %  
Peak intensity 0.8 cd/lm  
LEDs/each optic 1  
Light colour White  
Required components:

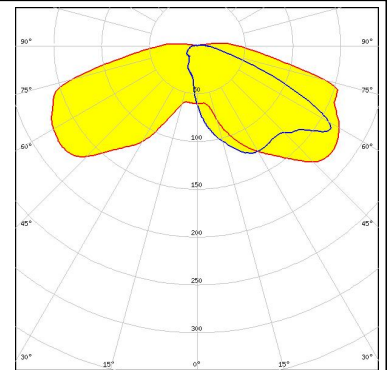

LED NVSxx19A  
FWHM Asymmetric  
Efficiency 92 %  
LEDs/each optic 1  
Light colour White  
Required components:



OSRAM  
Opto Semiconductors  
LED OSOLON SSL 150  
FWHM Asymmetric  
Efficiency 92 %  
Peak intensity 1.1 cd/lm  
LEDs/each optic 1  
Light colour White  
Required components:

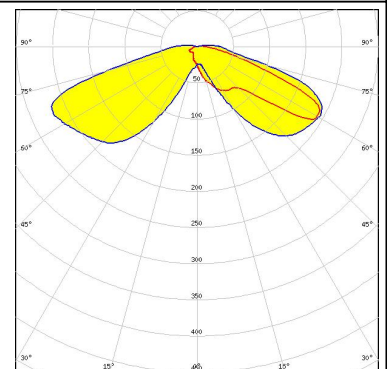

OSRAM  
Opto Semiconductors  
LED OSOLON SSL 80  
FWHM Asymmetric  
Efficiency 92 %  
LEDs/each optic 1  
Light colour White  
Required components:

### PHOTOMETRIC DATA (MEASURED):

#### PHILIPS

LED Fortimo FastFlex 2x8 DS G3  
FWHM Asymmetric  
Efficiency 90 %  
Peak intensity 0.9 cd/lm  
LEDs/each optic 1  
Light colour White  
Required components:

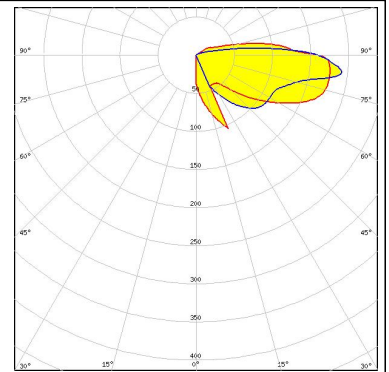

#### SAMSUNG

LED LH351Z  
FWHM Asymmetric  
Efficiency 94 %  
Peak intensity 1 cd/lm  
LEDs/each optic 1  
Light colour White  
Required components:

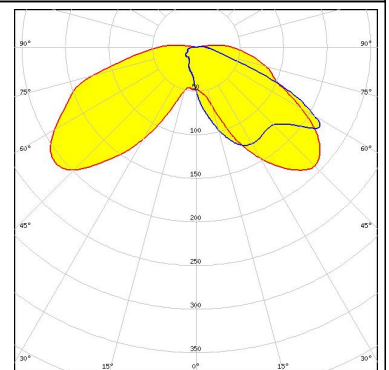

SEOUL SEMICONDUCTOR

LED Z5  
FWHM Asymmetric  
Efficiency 92 %  
LEDs/each optic 1  
Light colour White  
Required components:



SEOUL SEMICONDUCTOR

LED Z5M1/Z5M2  
FWHM Asymmetric  
Efficiency 94 %  
Peak intensity 0.9 cd/lm  
LEDs/each optic 1  
Light colour White  
Required components:

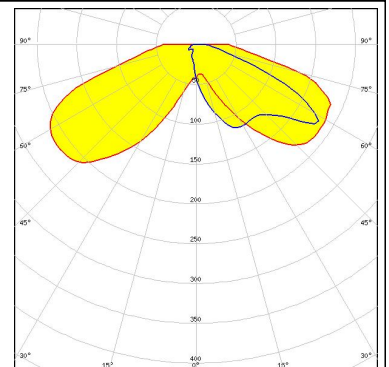



### PHOTOMETRIC DATA (SIMULATED):



LED NVSxx19B/NVSxx19C  
FWHM Asymmetric  
Efficiency 89 %  
Peak intensity 0.8 cd/lm  
LEDs/each optic 1  
Light colour White  
Required components:

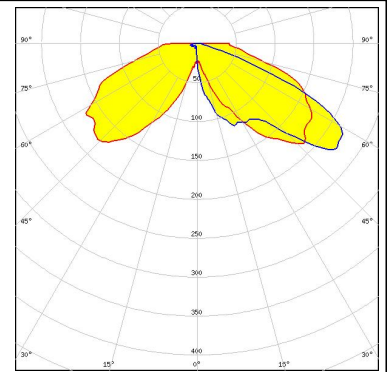

LED OSCONIQ P 3737 (3W version)  
FWHM Asymmetric  
Efficiency 91 %  
Peak intensity 0.8 cd/lm  
LEDs/each optic 1  
Light colour White  
Required components:

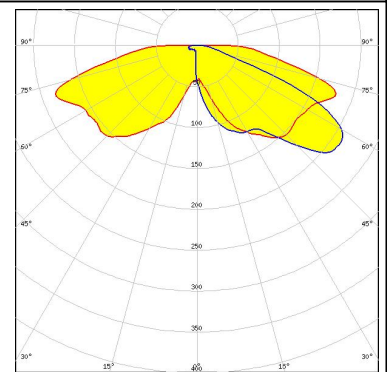

### GENERAL INFORMATION:

NOTE: The typical beam angle will be changed by different color, chip size and chip position tolerance. The typical total beam angle is the full angle measured where the luminous intensity is half of the peak value.

### MATERIALS:

As part of our continuous research and improvement processes, and to ensure the best possible quality and availability of our products, LEDiL reserves the right to change material grades without notice.

### PRODUCT DATA USER AGREEMENT AND DISCLAIMER:

The measured data in the provided downloadable LEDiL Product Datasheets and Mechanical 2D-Drawings is rounded and provided as reference for planning. LEDiL Oy's optical specifications have been verified by conducting performance testing of the products in accordance with the company's quality system. The reported data are averaged results of multiple measurements with typical variation. LEDiL Oy reserves the right to without prior notification make changes and improvements to its products.

LEDiL Oy assumes neither warranty, nor guarantee nor any other liability of any kind for the contents and correctness of the provided data. The provided data has been generated with highest diligence but the provided data may in reality not represent the complete possible variation range of all intrinsic parameters. Therefore, in certain cases a deviation from the provided data could occur.

LEDiL Oy reserves the right to undertake technical changes of its products without further notification which could lead to changes in the provided data. LEDiL Oy assumes no liability of any kind for the possible deviation from any provided data or any other damage resulting from the usage of the provided data.

The user agrees to this disclaimer and user agreement with the download or usage of the provided files.

#### LEDiL Oy

Joensuunkatu 13  
FI-24240 SALO  
Finland

#### LEDiL Inc.

228 West Page Street  
Suite D  
Sycamore IL 60178  
USA

#### Local sales and technical support

[www.ledil.com/  
where\\_to\\_buy](http://www.ledil.com/where_to_buy)

#### Shipping locations

Salo, Finland  
Hong Kong, China

#### Distribution Partners

[www.ledil.com/  
where\\_to\\_buy](http://www.ledil.com/where_to_buy)



Компания «ЭлектроПласт» предлагает заключение долгосрочных отношений при поставках импортных электронных компонентов на взаимовыгодных условиях!

Наши преимущества:

- Оперативные поставки широкого спектра электронных компонентов отечественного и импортного производства напрямую от производителей и с крупнейших мировых складов;
- Поставка более 17-ти миллионов наименований электронных компонентов;
- Поставка сложных, дефицитных, либо снятых с производства позиций;
- Оперативные сроки поставки под заказ (от 5 рабочих дней);
- Экспресс доставка в любую точку России;
- Техническая поддержка проекта, помощь в подборе аналогов, поставка прототипов;
- Система менеджмента качества сертифицирована по Международному стандарту ISO 9001;
- Лицензия ФСБ на осуществление работ с использованием сведений, составляющих государственную тайну;
- Поставка специализированных компонентов (Xilinx, Altera, Analog Devices, Intersil, Interpoint, Microsemi, Aeroflex, Peregrine, Syfer, Eurofarad, Texas Instrument, Miteq, Cobham, E2V, MA-COM, Hittite, Mini-Circuits, General Dynamics и др.);

Помимо этого, одним из направлений компании «ЭлектроПласт» является направление «Источники питания». Мы предлагаем Вам помощь Конструкторского отдела:

- Подбор оптимального решения, техническое обоснование при выборе компонента;
- Подбор аналогов;
- Консультации по применению компонента;
- Поставка образцов и прототипов;
- Техническая поддержка проекта;
- Защита от снятия компонента с производства.



#### Как с нами связаться

**Телефон:** 8 (812) 309 58 32 (многоканальный)

**Факс:** 8 (812) 320-02-42

**Электронная почта:** [org@eplast1.ru](mailto:org@eplast1.ru)

**Адрес:** 198099, г. Санкт-Петербург, ул. Калинина, дом 2, корпус 4, литера А.