

1

2

3

4

5

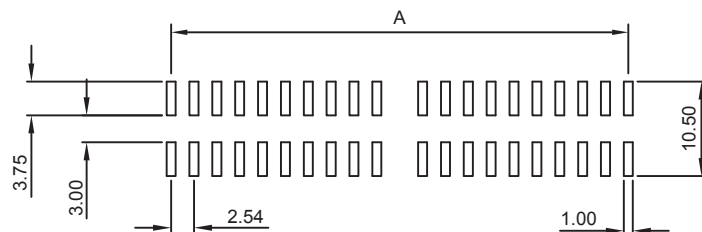

PCB LAYOUT - COMPONENT VIEW
TOLERANCE ±0.05MM

TECHNICAL CHARACTERISTICS

MATERIAL
 INSULATOR: PA 9T
 FLAMMABILITY: UL94-V0
 COLOR: BLACK
 CONTACT MATERIAL: COPPER ALLOYS
 CONTACT TYPE: STAMPED
 CONTACT PLATING: GOLD
 QUALITY CLASS: 3 AS PER CECC 75 301-802
 PITCH: 2.54MM

ENVIRONMENTAL
 OPERATING TEMPERATURE: -40°C UP TO 105°C
 COMPLIANCE: LEAD FREE AND ROHS

ELECTRICAL
 CURRENT RATING: 3A MAX
 WORKING VOLTAGE: 250 VAC
 INSULATOR RESISTANCE: >5000 MΩ
 DIELECTRIC WITHSTANDING VOLTAGE: 1000 VAC/MIN
 CONTACT RESISTANCE: 20 mΩ MAX

STANDARD
 CERTIFIED: E323964

SOLDERING
 JEDEC LEAD FREE REFLOW SOLDERING

PACKAGING
 TAPE & REEL WITH CAP

DIMENSION
 A = 2.54 x NB PINS/2 - 2.54
 B = 2.54 x NB PINS/2 + 5.2
 C = 2.54 x NB PINS/2 + 7.5

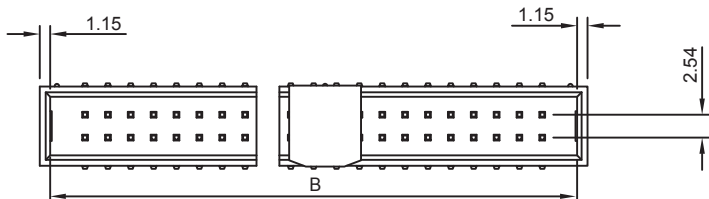
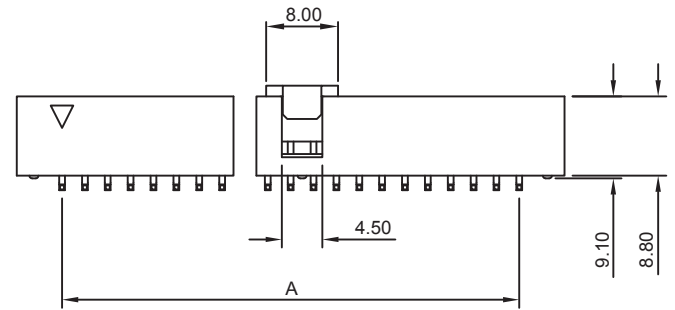
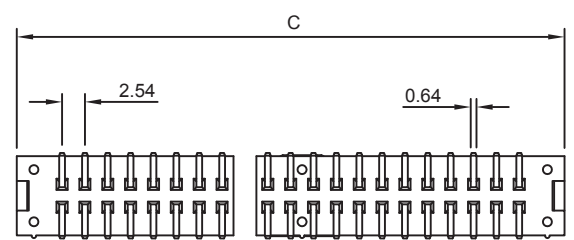
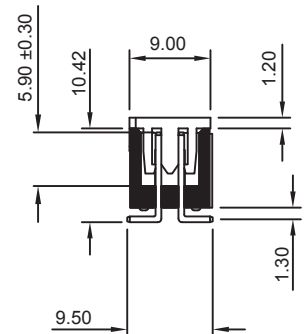

RoHS Compliant

L	10-NOV-14	GENERAL UPDATE	AS
K	08-APR-14	DIM B => 18.02	QL
J	13-JUN-13	DIM 5.08	QL
I	22-JUL-11	W DIMENTION	QL
H	24-MAY-11	NOTE	GG
REV	DATE	FILE	BY

PROJECTION:

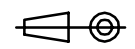

APPROVAL: GMo

GENERAL TOLERANCE

.X = +/- 0.2
.XX = +/- 0.15

UNIT: MM

SCALE:

SHEET: 1/3

DRAW: AS



DESCRIPTION: WR-BHD - 2.54MM MALE SMT BOX HEADER

WERI PART NO: 612 3xx 206 21

SIZE

A4

A

B

C

D

1

2

3

4

5

ITEM	A0	K0	K1	P	E	D	D1	P0	P2
DIM	9.8 ^{+0.1} _{-0.1}	11.9 ^{+0.1} _{-0.1}	0 ^{+0.1} _{-0.1}	20 ^{+0.1} _{-0.1}	1.75 ^{+0.1} _{-0.1}	1.5 ^{+0.1} _{-0.0}	2.0 ^{+0.25} _{-0.0}	4.0 ^{+0.1} _{-0.1}	2.0 ^{+0.1} _{-0.1}

CIRCUITS	W	B0	F	CIRCUITS	W	B0	F
06	44	15.42	20.25	24	56	38.28	26.25
08	44	17.96	20.25	26	56	40.82	26.25
10	44	20.50	20.25	30	72	45.90	34.25
12	44	23.04	20.25	34	72	50.98	34.25
14	44	25.58	20.25	40	72	58.60	34.25
16	44	28.12	20.25	44	88	63.68	42.25
18	44	30.66	20.25	50	88	71.30	42.25
20	56	33.20	26.25				

PULL OUT DIRECTION

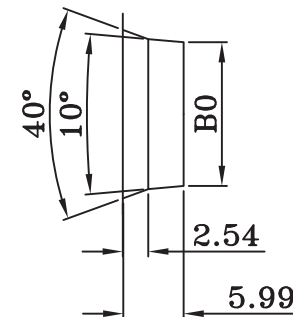
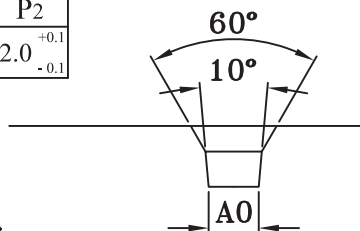
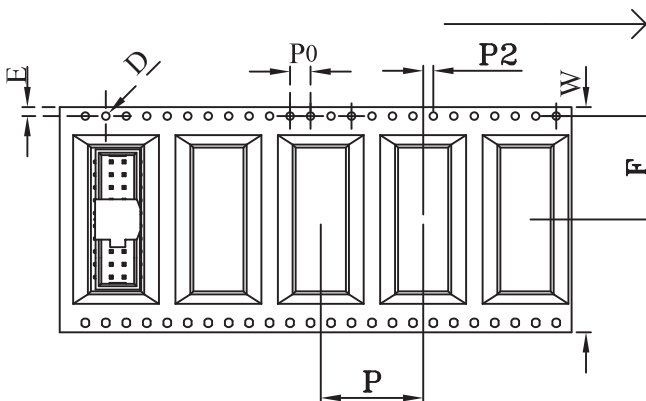
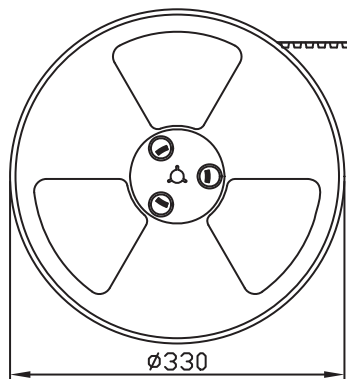

A

B

C

D

RoHS Compliant

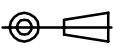
G				PROJECTION: 
F				
E				
D				
C				
B				APPROVAL: GMo
A				
REV	DATE	FILE	BY	

GENERAL TOLERANCE .X = +/- 0.2 .XX = +/- 0.15	 WÜRTH ELEKTRONIK
UNIT: MM	
SCALE:	
SHEET: 2/3	
DRAW: AS	DESCRIPTION: WR-BHD 2.54MM MALE SMT BOX HEADER
	WERI PART NO: 612 3xx 206 21

SIZE	A4

1

2

3

4

5

Cautions and Warnings:

This electronic component is designed and developed with the intention for use in general electronics equipments.

Before incorporating the components into any equipments in the field such as aerospace, aviation, nuclear control, submarine, transportation, (automotive control, train control, ship control), transportation signal, disaster prevention, medical, public information network etc. where higher safety and reliability are especially required or if there is possibility of direct damage or injury to human body, Würth Elektronik must be asked for a written approval.

In addition, even electronic component in general electronic equipments, when used in electrical circuits that require high safety, reliability functions or performance, the sufficient reliability evaluation-check for the safety must be performed before by the user before usage.

A

B

C

RoHS Compliant

G				PROJECTION: 	GENERAL TOLERANCE .X = +/- 0.2 .XX = +/- 0.15		
F							
E							
D							
C				APPROVAL: JC	UNIT: MM	DESCRIPTION: DISCLAIMER	SIZE A4
B					SCALE:		
A	10-SEP-14	PDF	QL		SHEET: 3/3	WERI PART NO: DISCLAIMER	
REV	DATE	FILE	BY		DRAW: QL		

D



Компания «ЭлектроПласт» предлагает заключение долгосрочных отношений при поставках импортных электронных компонентов на взаимовыгодных условиях!

Наши преимущества:

- Оперативные поставки широкого спектра электронных компонентов отечественного и импортного производства напрямую от производителей и с крупнейших мировых складов;
- Поставка более 17-ти миллионов наименований электронных компонентов;
- Поставка сложных, дефицитных, либо снятых с производства позиций;
- Оперативные сроки поставки под заказ (от 5 рабочих дней);
- Экспресс доставка в любую точку России;
- Техническая поддержка проекта, помощь в подборе аналогов, поставка прототипов;
- Система менеджмента качества сертифицирована по Международному стандарту ISO 9001;
- Лицензия ФСБ на осуществление работ с использованием сведений, составляющих государственную тайну;
- Поставка специализированных компонентов (Xilinx, Altera, Analog Devices, Intersil, Interpoint, Microsemi, Aeroflex, Peregrine, Syfer, Eurofarad, Texas Instrument, Miteq, Cobham, E2V, MA-COM, Hittite, Mini-Circuits, General Dynamics и др.);

Помимо этого, одним из направлений компании «ЭлектроПласт» является направление «Источники питания». Мы предлагаем Вам помощь Конструкторского отдела:

- Подбор оптимального решения, техническое обоснование при выборе компонента;
- Подбор аналогов;
- Консультации по применению компонента;
- Поставка образцов и прототипов;
- Техническая поддержка проекта;
- Защита от снятия компонента с производства.



Как с нами связаться

Телефон: 8 (812) 309 58 32 (многоканальный)

Факс: 8 (812) 320-02-42

Электронная почта: org@eplast1.ru

Адрес: 198099, г. Санкт-Петербург, ул. Калинина, дом 2, корпус 4, литера А.