

# MJTP SERIES 6MM THRU-HOLE MTG. TACT SWITCHES

## FEATURES

- Numerous single pole-single throw momentary configurations.
- Excellent tactile feed-back (Snap dome).
- Ultra-compact size.
- Long operating life for high reliability.
- Molded-in terminals minimize wicking of flux or solder.

## MATERIALS

Case: Thermoplastic, color black. UL94HB Standard.  
 Actuator: Thermoplastic  
 Cover/Bracket: PET film, tin plated brass or stainless steel.  
 Terminals: Silver plated brass.  
 Shorting Contact: Phosphor bronze or stainless steel with silver plating.  
 L.E.D. rating: Forward voltage- 2.1 V (3.0 V Max.). Cont. fwd. current 20mA max. @ 25°C.

Gold plating available on contacts & terminals - consult factory.

SPECIFICATIONS SUBJECT TO CHANGE WITHOUT NOTICE.

## GENERAL SPECIFICATIONS

### ELECTRICALS

Contact rating: 50 mA @ 12 VDC  
 Insulation resistance: 100 megohms min. (100 VDC)  
 Dielectric withstanding voltage: 250 VAC for 1 minute  
 Contact resistance: 100 milliohms max. @ 5 VDC, 10 mA  
 Electrical life: 100,000 cycles min. (except models MJTP1243 & 1250- 50,000 cycles)  
 1,000,000 cycles available - consult factory  
 Contact bounce: less than 10 msec.

### MECHANICALS, THERMALS, ENVIRONMENTALS

Plunger travel: .010" + .008", - .004" (0,25 +0,2, -0,1 mm)  
 Actuation force: 160 grams ±30 grams  
 Operating temperature range: -20°C to +70°C  
 Storage temperature range: -30°C to +80°C for 96 hours  
 Shock resistance: 30G per method 213, MIL-STD-202  
 Vibration resistance: passes method 201, MIL-STD-202

### SOLDERING (note - non-washable except for models indicated 'process compatible' below).

IR reflow soldering: 240°C max. for 20 seconds max.  
 Wave soldering: 255°C max. for 5 seconds max.  
 Hand soldering: 320°C max. for 3.5 seconds max. (40 watt iron max.)

#### MJTP1105T

Right angle, grounding

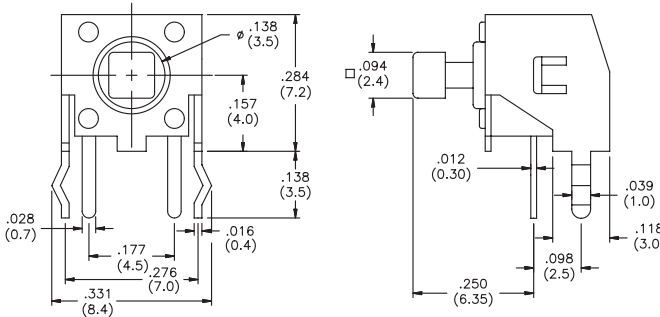

Caps available - see end of section.  
Bulk packaged.

#### US # MJTP1109

#### EU # PHAP3350

Process compatible, grounding

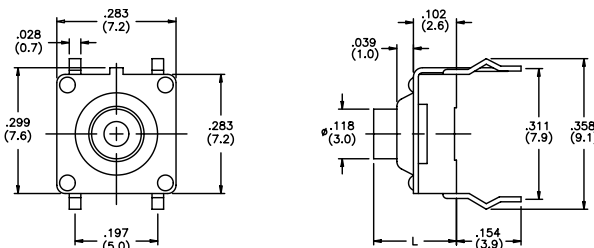

| US Model No. | Dim. L (In./mm) | EU Model No. |
|--------------|-----------------|--------------|
| MJTP1109     | .197 (5.0)      | PHAP3350     |
| MJTP1109A    | .354 (9.0)      | PHAP3350A    |
| MJTP1109B    | .512 (13.0)     | PHAP3350B    |

Bulk packaged.

M

**US # MJTP1117**  
**EU # PHAP3363**  
 Right angle,  
 grounding



New!

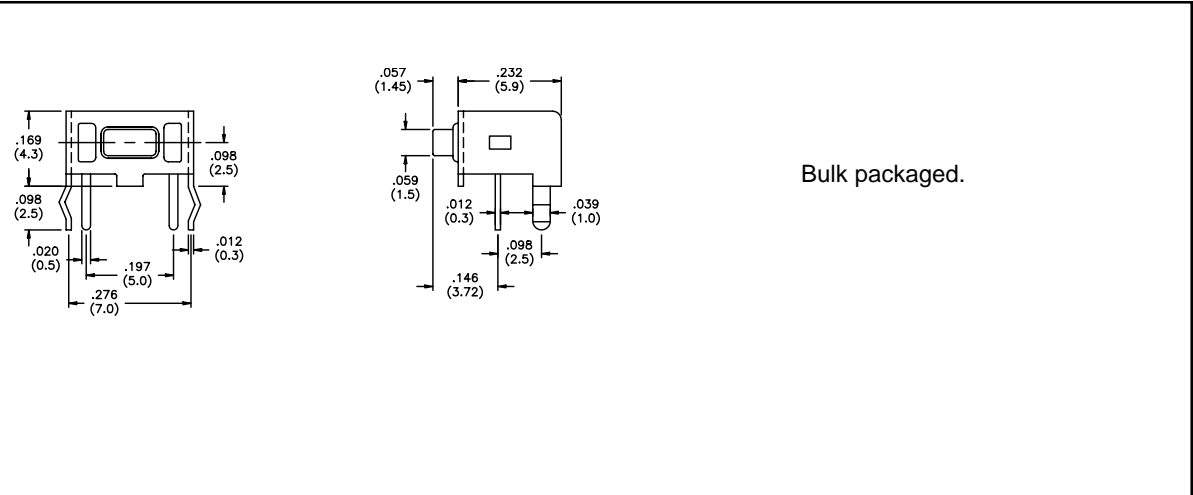

Bulk packaged.

**US # MJTP1119**  
**EU # PHAP3351**  
 Process compatible



New!

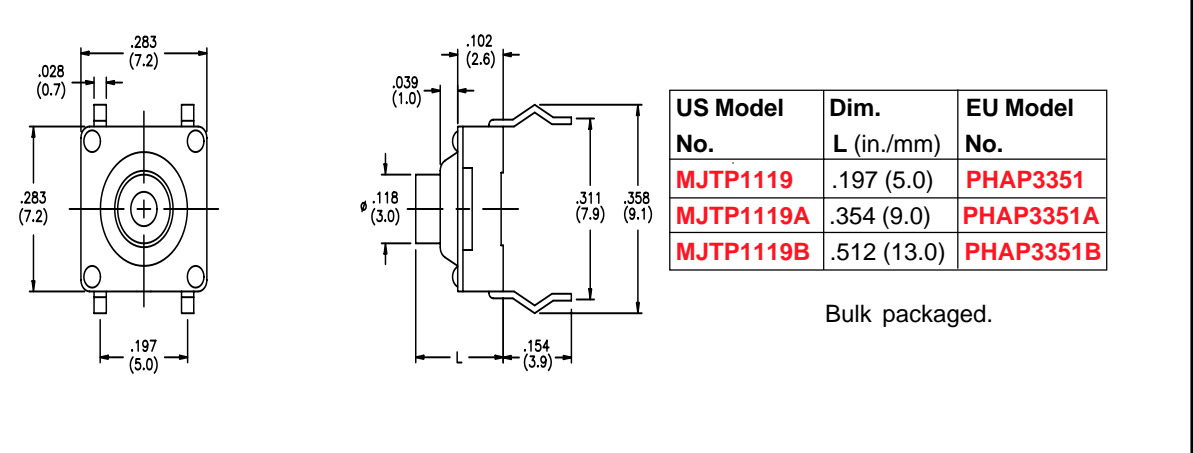

| US Model No.     | Dim. L (in./mm) | EU Model No.     |
|------------------|-----------------|------------------|
| <b>MJTP1119</b>  | .197 (5.0)      | <b>PHAP3351</b>  |
| <b>MJTP1119A</b> | .354 (9.0)      | <b>PHAP3351A</b> |
| <b>MJTP1119B</b> | .512 (13.0)     | <b>PHAP3351B</b> |

Bulk packaged.

**US # MJTP1129**  
**EU # PHAP1152**  
 Right angle,  
 grounding,  
 process compatible

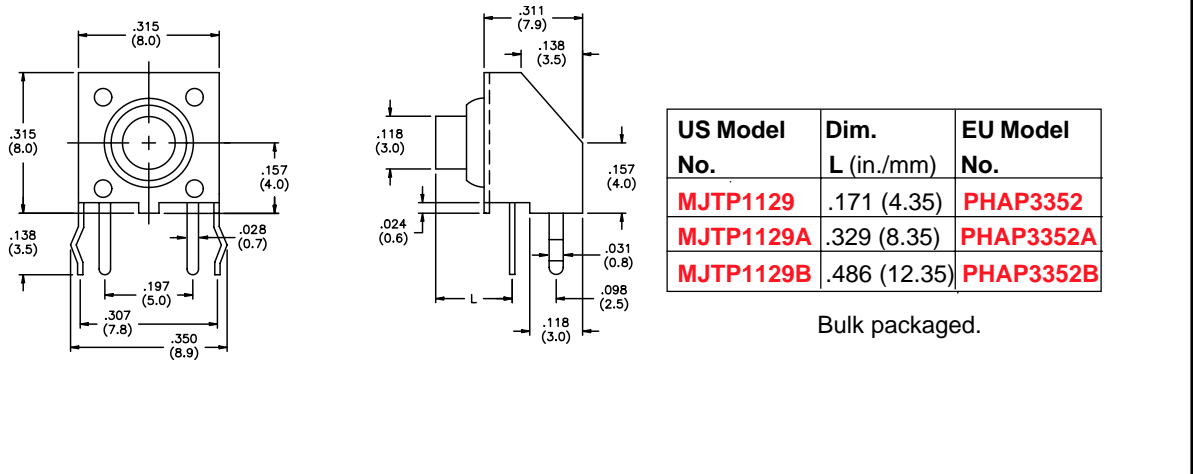

| US Model No.     | Dim. L (in./mm) | EU Model No.     |
|------------------|-----------------|------------------|
| <b>MJTP1129</b>  | .171 (4.35)     | <b>PHAP3352</b>  |
| <b>MJTP1129A</b> | .329 (8.35)     | <b>PHAP3352A</b> |
| <b>MJTP1129B</b> | .486 (12.35)    | <b>PHAP3352B</b> |

Bulk packaged.

**US # MJTP1141**  
**EU # PHAP3307**  
 Long terminals

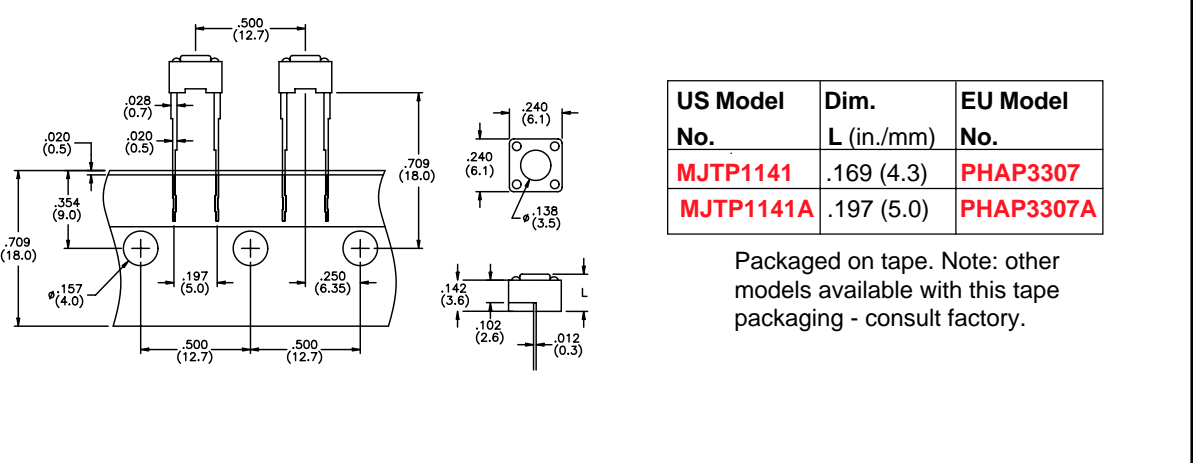

| US Model No.     | Dim. L (in./mm) | EU Model No.     |
|------------------|-----------------|------------------|
| <b>MJTP1141</b>  | .169 (4.3)      | <b>PHAP3307</b>  |
| <b>MJTP1141A</b> | .197 (5.0)      | <b>PHAP3307A</b> |

Packaged on tape. Note: other models available with this tape packaging - consult factory.

SPECIFICATIONS SUBJECT TO CHANGE WITHOUT NOTICE.

**US # MJTP1193**  
**EU # PHAP3308**  
 With L.E.D.



**New!**

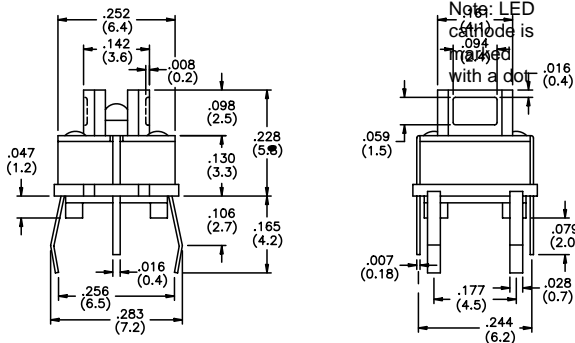

| US Model No.     | L.E.D. Color | EU Model No.     |
|------------------|--------------|------------------|
| <b>MJTP1193</b>  | No L.E.D.    | <b>PHAP3308</b>  |
| <b>MJTP11936</b> | Red          | <b>PHAP3308R</b> |
| <b>MJTP11935</b> | Yellow       | <b>PHAP3308Y</b> |
| <b>MJTP11933</b> | Green        | <b>PHAP3308G</b> |

Caps available with lens - see end of section.  
 Bulk packaged.

**US # MJTP1230**  
**EU # PHAP3301**

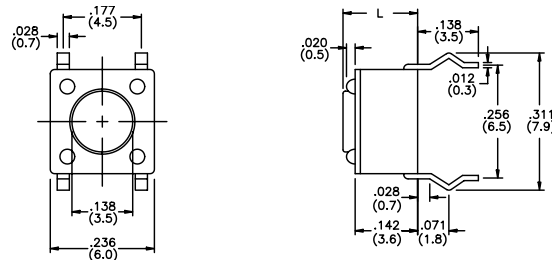

| US Model No.     | Dim. L (in./mm) | EU Model No.     |
|------------------|-----------------|------------------|
| <b>MJTP1230</b>  | .170 (4,3)      | <b>PHAP3301</b>  |
| <b>MJTP1230A</b> | .197 (5,0)      | <b>PHAP3301A</b> |
| <b>MJTP1230B</b> | .374 (9,5)      | <b>PHAP3301B</b> |
| <b>MJTP1230C</b> | .315 (8,0)      | <b>PHAP3301C</b> |
| <b>MJTP1230D</b> | .512 (13,0)     | <b>PHAP3301D</b> |
| <b>MJTP1230E</b> | .287 (7,3)      | <b>PHAP3301E</b> |
| <b>MJTP1230F</b> | .335 (8,5)      | <b>PHAP3301F</b> |
| <b>MJTP1230G</b> | .275 (7,0)      | N/A              |

Bulk packaged.

**US # MJTP1232**  
**EU # PHAP3302**  
 Grounding

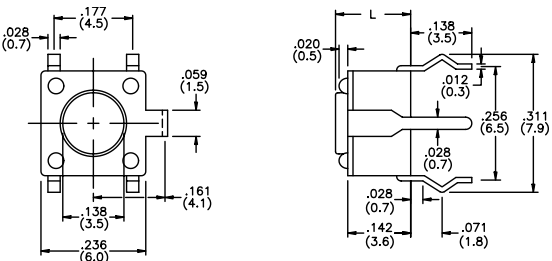

| US Model No.     | Dim. L (in./mm) | EU Model No.     |
|------------------|-----------------|------------------|
| <b>MJTP1232</b>  | .170 (4,3)      | <b>PHAP3302</b>  |
| <b>MJTP1232A</b> | .197 (5,0)      | <b>PHAP3302A</b> |
| <b>MJTP1232B</b> | .374 (9,5)      | <b>PHAP3302B</b> |
| <b>MJTP1232C</b> | .315 (8,0)      | <b>PHAP3302C</b> |
| <b>MJTP1232D</b> | .512 (13,0)     | <b>PHAP3302D</b> |
| <b>MJTP1232E</b> | .287 (7,3)      | <b>PHAP3302E</b> |
| <b>MJTP1232F</b> | .335 (8,5)      | <b>PHAP3302F</b> |
| <b>MJTP1232G</b> | .275 (7,0)      | <b>PHAP3302G</b> |

Bulk packaged.

**US # MJTP1234**  
**EU # PHAP3303**

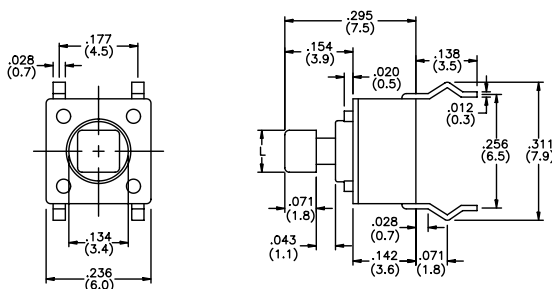

| US Model No.     | Dim. L (in./mm) | EU Model No.     |
|------------------|-----------------|------------------|
| <b>MJTP1234</b>  | .094 (2,4)      | <b>PHAP3303</b>  |
| <b>MJTP1234A</b> | .110 (2,8)      | <b>PHAP3303A</b> |

Caps available - see end of section.  
 Bulk packaged.



**US # MJTP1236**  
**EU # PHAP3305**  
 Right angle,  
 grounding

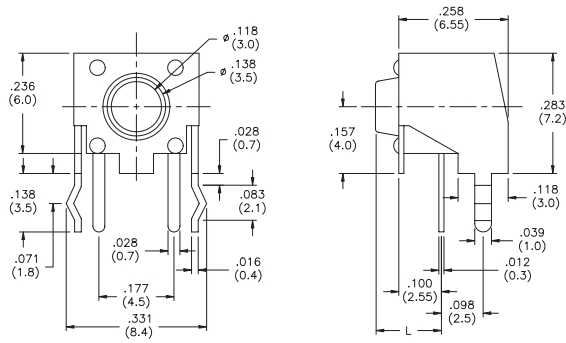

| US Model No.     | Dim. L (in./mm) | EU Model No.     |
|------------------|-----------------|------------------|
| <b>MJTP1236</b>  | .124 (3,1)      | <b>PHAP3305</b>  |
| <b>MJTP1236A</b> | .152 (3,9)      | <b>PHAP3305A</b> |
| <b>MJTP1236B</b> | .329 (8,4)      | <b>PHAP3305B</b> |
| <b>MJTP1236C</b> | .270 (6,9)      | <b>PHAP3305C</b> |
| <b>MJTP1236D</b> | .466 (11,9)     | <b>PHAP3305D</b> |
| <b>MJTP1236E</b> | .244 (6,2)      | <b>PHAP3305E</b> |
| <b>MJTP1236F</b> | .289 (7,3)      | N/A              |
| <b>MJTP1236G</b> | .230 (5,8)      | N/A              |

Bulk packaged.

**US # MJTP1243 & MJTP1250**

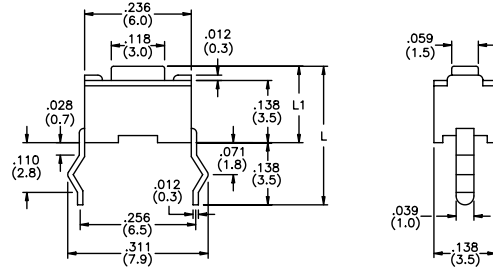

| US # Model No.  | Dim. L1 (in./mm) | Dim. L (in./mm) |
|-----------------|------------------|-----------------|
| <b>MJTP1243</b> | .169 (4,3)       | .307 (7,8)      |
| <b>MJTP1250</b> | .197 (5,0)       | .335 (8,5)      |

Bulk packaged.

**US # MJTP2205**  
**EU # PHAP3306**  
 2 switch vertical  
 gang assembly,  
 black actuators

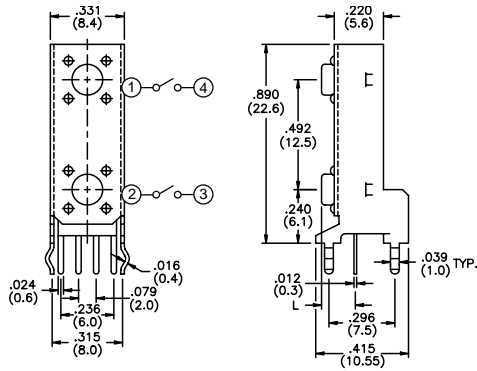

| US Model No.     | Dim. L (in./mm) | EU Model No.     |
|------------------|-----------------|------------------|
| <b>MJTP2205</b>  | .124 (3,15)     | <b>PHAP3306</b>  |
| <b>MJTP2205A</b> | .152 (3,85)     | <b>PHAP3306A</b> |
| <b>MJTP2205B</b> | .329 (8,35)     | <b>PHAP3306B</b> |
| <b>MJTP2205C</b> | .270 (6,85)     | <b>PHAP3306C</b> |
| <b>MJTP2205D</b> | .466 (11,85)    | <b>PHAP3306D</b> |
| <b>MJTP2205E</b> | .242 (6,15)     | <b>PHAP3306E</b> |

Bulk packaged.

SPECIFICATIONS SUBJECT TO CHANGE WITHOUT NOTICE.

**US # MJTPSHW**  
Process compatible

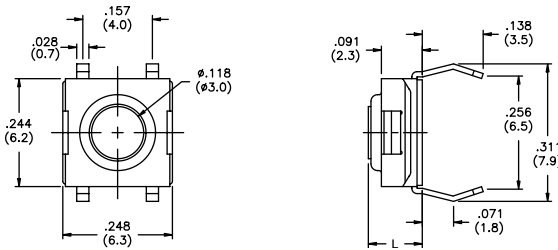

| US # Model No.  | Dim. L (in./mm) |
|-----------------|-----------------|
| <b>MJTPSHW</b>  | .122 (3,1)      |
| <b>MJTPSHWA</b> | .091 (2,3)      |
| <b>MJTPSHWB</b> | .146 (3,8)      |

Bulk packaged.

**CAPS** (for MJTP1105T and MJTP1234 only)

**CAPS** (for MJTP1193 only)

**New!**

**CAP COLORS**

**MJ61** Square cap

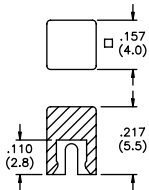

**MJ62** Round cap

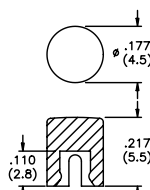

**MJ3** Square cap (w/clear lens in center for LED illumination)

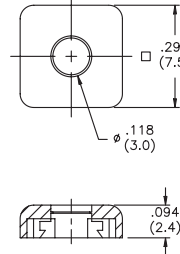

Note - add digit from table to cap part number for color. Example - **MJ612** indicates square black cap.

| No.      | Color  |
|----------|--------|
| <b>1</b> | blue   |
| <b>2</b> | black  |
| <b>3</b> | green  |
| <b>5</b> | yellow |
| <b>6</b> | red    |
| <b>7</b> | ivory  |

**SCHEMATICS**

MJTP1109  
MJTP1119  
MJTP1193  
MJTP1230  
MJTP1232

MJTP1234  
MJTP2205  
MJTP4102  
MJTP5302  
MJTPSHW

Note: LED is for MJTP1193 only.

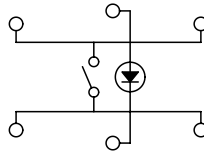

MJTP1105  
MJTP1117  
MJTP1129  
MJTP1141  
MJTP1144  
MJTP1145

MJTP1236  
MJTP1243  
MJTP1250  
MJTP2205  
MJTP4102  
MJTP5302

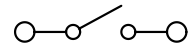

**M**

**PRINTED CIRCUIT BOARD LAYOUTS**

Layout tolerances; Linear:  $\pm .004"$  ( $\pm 0,1MM$ ) Holes:  $\pm .002"$  ( $\pm 0,05MM$ )

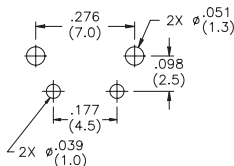

**MJTP1105T**

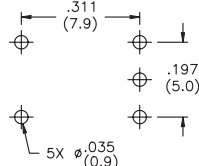

**MJTP1109**

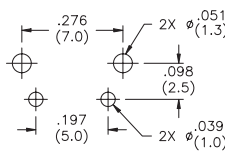

**MJTP1117**

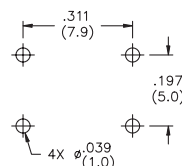

**MJTP1119**

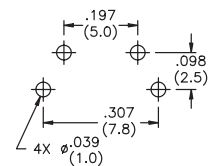

**MJTP1129**

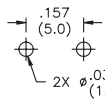

**MJTP1141, 44 & 45**

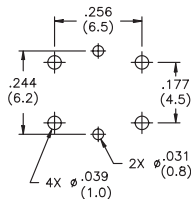

**MJTP1193**

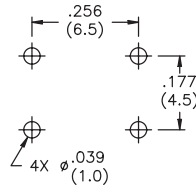

**MJTP1230**

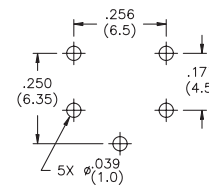

**MJTP1232**

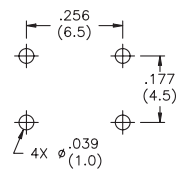

**MJTP1234**

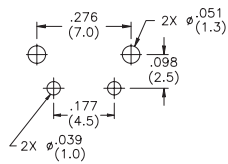

**MJTP1236**

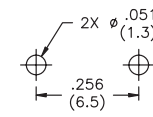

**MJTP1243**

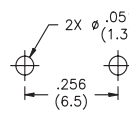

**MJTP1250**

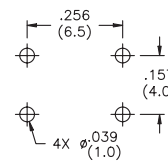

**MJTPSHW**

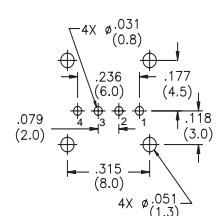

**MJTP2205**

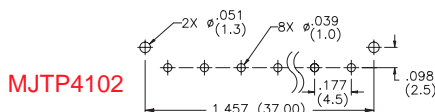

**MJTP4102**

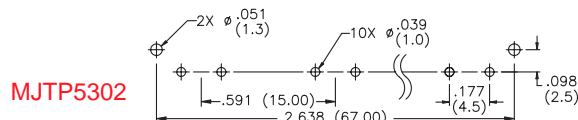

**MJTP5302**



Компания «ЭлектроПласт» предлагает заключение долгосрочных отношений при поставках импортных электронных компонентов на взаимовыгодных условиях!

Наши преимущества:

- Оперативные поставки широкого спектра электронных компонентов отечественного и импортного производства напрямую от производителей и с крупнейших мировых складов;
- Поставка более 17-ти миллионов наименований электронных компонентов;
- Поставка сложных, дефицитных, либо снятых с производства позиций;
- Оперативные сроки поставки под заказ (от 5 рабочих дней);
- Экспресс доставка в любую точку России;
- Техническая поддержка проекта, помощь в подборе аналогов, поставка прототипов;
- Система менеджмента качества сертифицирована по Международному стандарту ISO 9001;
- Лицензия ФСБ на осуществление работ с использованием сведений, составляющих государственную тайну;
- Поставка специализированных компонентов (Xilinx, Altera, Analog Devices, Intersil, Interpoint, Microsemi, Aeroflex, Peregrine, Syfer, Eurofarad, Texas Instrument, Miteq, Cobham, E2V, MA-COM, Hittite, Mini-Circuits, General Dynamics и др.);

Помимо этого, одним из направлений компании «ЭлектроПласт» является направление «Источники питания». Мы предлагаем Вам помощь Конструкторского отдела:

- Подбор оптимального решения, техническое обоснование при выборе компонента;
- Подбор аналогов;
- Консультации по применению компонента;
- Поставка образцов и прототипов;
- Техническая поддержка проекта;
- Защита от снятия компонента с производства.



#### Как с нами связаться

**Телефон:** 8 (812) 309 58 32 (многоканальный)

**Факс:** 8 (812) 320-02-42

**Электронная почта:** [org@eplast1.ru](mailto:org@eplast1.ru)

**Адрес:** 198099, г. Санкт-Петербург, ул. Калинина, дом 2, корпус 4, литера А.