

# MJTP SERIES 6MM THRU-HOLE MTG. TACT SWITCHES

## FEATURES

- Numerous single pole-single throw momentary configurations.
- Excellent tactile feed-back (Snap dome).
- Ultra-compact size.
- Long operating life for high reliability.
- Molded-in terminals minimize wicking of flux or solder.

## MATERIALS

Case:	Thermoplastic, color black. UL94HB Standard.
Actuator:	Thermoplastic
Cover/Bracket:	PET film, tin plated brass or stainless steel.
Terminals:	Silver plated brass.
Shorting Contact:	Phosphor bronze or stainless steel with silver plating.
L.E.D. rating:	Forward voltage- 2.1 V (3.0 V Max.). Cont. fwd. current 20mA max. @ 25°C.

Gold plating available on contacts & terminals  
- consult factory.

SPECIFICATIONS SUBJECT TO CHANGE WITHOUT NOTICE.

## GENERAL SPECIFICATIONS

### ELECTRICALS

Contact rating:	50 mA @ 12 VDC
Insulation resistance:	100 megohms min. (100 VDC)
Dielectric withstanding voltage:	250 VAC for 1 minute
Contact resistance:	100 milliohms max. @ 5 VDC, 10 mA
Electrical life:	100,000 cycles min. (except models MJTP1243 & 1250- 50,000 cycles) 1,000,000 cycles available - consult factory
Contact bounce:	less than 10 msec.

### MECHANICALS, THERMALS, ENVIRONMENTALS

Plunger travel:	.010" + .008", - .004" (0,25 +0,2, -0,1 mm)
Actuation force:	160 grams ±30 grams
Operating temperature range:	-20°C to +70°C
Storage temperature range:	-30°C to +80°C for 96 hours
Shock resistance:	30G per method 213, MIL-STD-202
Vibration resistance:	passes method 201, MIL-STD-202

### SOLDERING (note - non-washable except for models indicated 'process compatible' below).

IR reflow soldering:	240°C max. for 20 seconds max.
Wave soldering:	255°C max. for 5 seconds max.
Hand soldering:	320°C max. for 3.5 seconds max. (40 watt iron max.)

#### MJTP1105T

Right angle, grounding

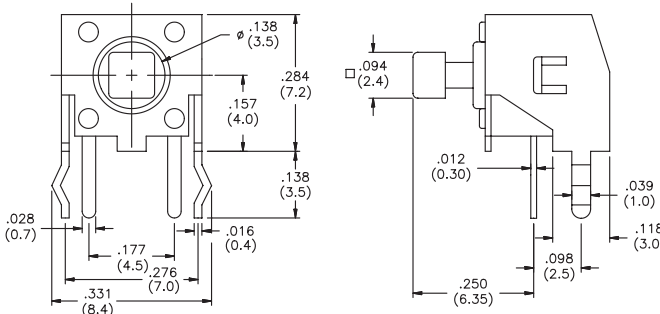

Caps available - see end of section.  
Bulk packaged.

#### US # MJTP1109

#### EU # PHAP3350

Process compatible, grounding

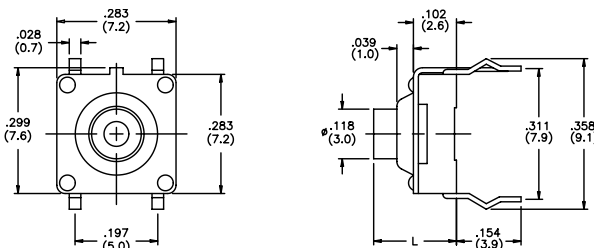

US Model No.	Dim. L (In./mm)	EU Model No.
MJTP1109	.197 (5.0)	PHAP3350
MJTP1109A	.354 (9.0)	PHAP3350A
MJTP1109B	.512 (13.0)	PHAP3350B

Bulk packaged.

**US # MJTP1117**  
**EU # PHAP3363**  
 Right angle,  
 grounding

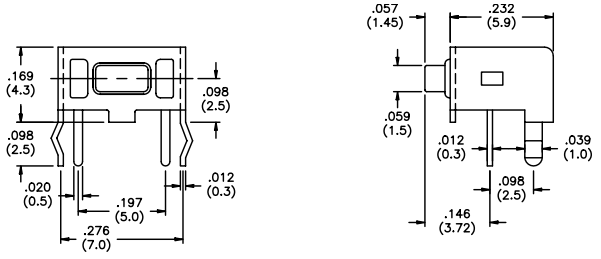

Bulk packaged.

New!

**US # MJTP1119**  
**EU # PHAP3351**  
 Process compatible

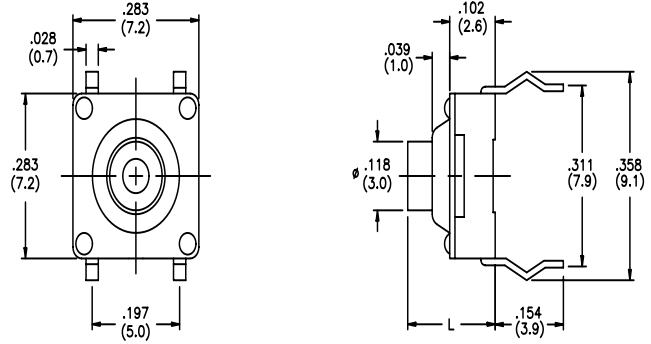

US Model No.	Dim. L (in./mm)	EU Model No.
<b>MJTP1119</b>	.197 (5.0)	<b>PHAP3351</b>
<b>MJTP1119A</b>	.354 (9.0)	<b>PHAP3351A</b>
<b>MJTP1119B</b>	.512 (13.0)	<b>PHAP3351B</b>

Bulk packaged.

New!

**US # MJTP1129**  
**EU # PHAP1152**  
 Right angle,  
 grounding,  
 process compatible

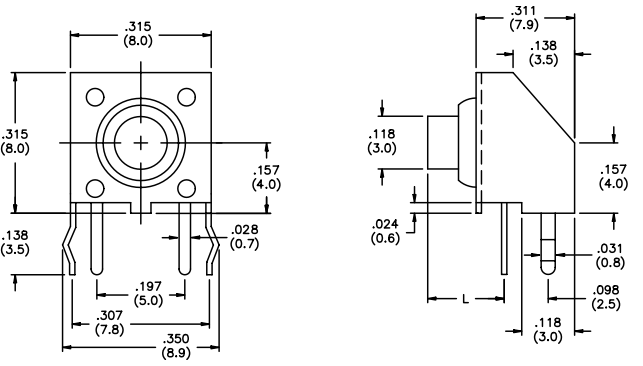

US Model No.	Dim. L (in./mm)	EU Model No.
<b>MJTP1129</b>	.171 (4.35)	<b>PHAP3352</b>
<b>MJTP1129A</b>	.329 (8.35)	<b>PHAP3352A</b>
<b>MJTP1129B</b>	.486 (12.35)	<b>PHAP3352B</b>

Bulk packaged.

**US # MJTP1141**  
**EU # PHAP3307**  
 Long terminals

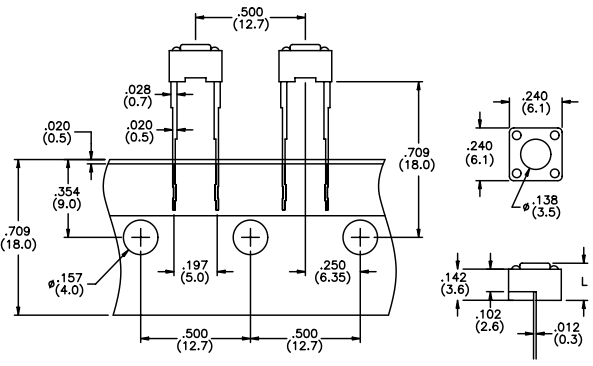

US Model No.	Dim. L (in./mm)	EU Model No.
<b>MJTP1141</b>	.169 (4.3)	<b>PHAP3307</b>
<b>MJTP1141A</b>	.197 (5.0)	<b>PHAP3307A</b>

Packaged on tape. Note: other models available with this tape packaging - consult factory.

M

SPECIFICATIONS SUBJECT TO CHANGE WITHOUT NOTICE.

**US # MJTP1193**  
**EU # PHAP3308**  
With L.E.D.



**New!**



US Model No.	L.E.D. Color	EU Model No.
<b>MJTP1193</b>	No L.E.D.	<b>PHAP3308</b>
<b>MJTP11936</b>	Red	<b>PHAP3308R</b>
<b>MJTP11935</b>	Yellow	<b>PHAP3308Y</b>
<b>MJTP11933</b>	Green	<b>PHAP3308G</b>

Caps available with lens - see end of section.  
Bulk packaged.

**US # MJTP1230**  
**EU # PHAP3301**

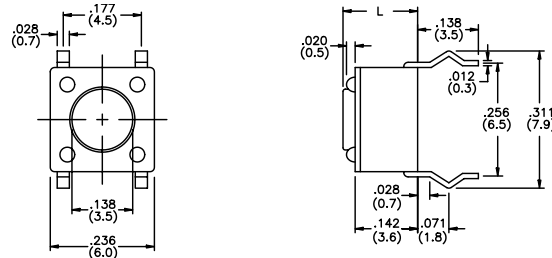

US Model No.	Dim. L (in./mm)	EU Model No.
<b>MJTP1230</b>	.170 (4,3)	<b>PHAP3301</b>
<b>MJTP1230A</b>	.197 (5,0)	<b>PHAP3301A</b>
<b>MJTP1230B</b>	.374 (9,5)	<b>PHAP3301B</b>
<b>MJTP1230C</b>	.315 (8,0)	<b>PHAP3301C</b>
<b>MJTP1230D</b>	.512 (13,0)	<b>PHAP3301D</b>
<b>MJTP1230E</b>	.287 (7,3)	<b>PHAP3301E</b>
<b>MJTP1230F</b>	.335 (8,5)	<b>PHAP3301F</b>
<b>MJTP1230G</b>	.275 (7,0)	N/A

Bulk packaged.

**US # MJTP1232**  
**EU # PHAP3302**  
Grounding

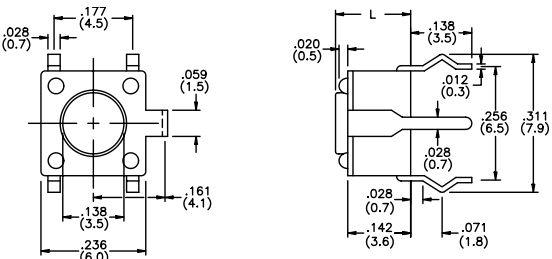

US Model No.	Dim. L (in./mm)	EU Model No.
<b>MJTP1232</b>	.170 (4,3)	<b>PHAP3302</b>
<b>MJTP1232A</b>	.197 (5,0)	<b>PHAP3302A</b>
<b>MJTP1232B</b>	.374 (9,5)	<b>PHAP3302B</b>
<b>MJTP1232C</b>	.315 (8,0)	<b>PHAP3302C</b>
<b>MJTP1232D</b>	.512 (13,0)	<b>PHAP3302D</b>
<b>MJTP1232E</b>	.287 (7,3)	<b>PHAP3302E</b>
<b>MJTP1232F</b>	.335 (8,5)	<b>PHAP3302F</b>
<b>MJTP1232G</b>	.275 (7,0)	<b>PHAP3302G</b>

Bulk packaged.

**US # MJTP1234**  
**EU # PHAP3303**



US Model No.	Dim. L (in./mm)	EU Model No.
<b>MJTP1234</b>	.094 (2,4)	<b>PHAP3303</b>
<b>MJTP1234A</b>	.110 (2,8)	<b>PHAP3303A</b>

Caps available - see end of section.  
Bulk packaged.



**US # MJTP1236**  
**EU # PHAP3305**  
 Right angle,  
 grounding



US Model No.	Dim. L (in./mm)	EU Model No.
<b>MJTP1236</b>	.124 (3,1)	<b>PHAP3305</b>
<b>MJTP1236A</b>	.152 (3,9)	<b>PHAP3305A</b>
<b>MJTP1236B</b>	.329 (8,4)	<b>PHAP3305B</b>
<b>MJTP1236C</b>	.270 (6,9)	<b>PHAP3305C</b>
<b>MJTP1236D</b>	.466 (11,9)	<b>PHAP3305D</b>
<b>MJTP1236E</b>	.244 (6,2)	<b>PHAP3305E</b>
<b>MJTP1236F</b>	.289 (7,3)	N/A
<b>MJTP1236G</b>	.230 (5,8)	N/A

Bulk packaged.

**US # MJTP1243 & MJTP1250**



US # Model No.	Dim. L1 (in./mm)	Dim. L (in./mm)
<b>MJTP1243</b>	.169 (4,3)	.307 (7,8)
<b>MJTP1250</b>	.197 (5,0)	.335 (8,5)

Bulk packaged.

**US # MJTP2205**  
**EU # PHAP3306**  
 2 switch vertical  
 gang assembly,  
 black actuators



US Model No.	Dim. L (in./mm)	EU Model No.
<b>MJTP2205</b>	.124 (3,15)	<b>PHAP3306</b>
<b>MJTP2205A</b>	.152 (3,85)	<b>PHAP3306A</b>
<b>MJTP2205B</b>	.329 (8,35)	<b>PHAP3306B</b>
<b>MJTP2205C</b>	.270 (6,85)	<b>PHAP3306C</b>
<b>MJTP2205D</b>	.466 (11,85)	<b>PHAP3306D</b>
<b>MJTP2205E</b>	.242 (6,15)	<b>PHAP3306E</b>

Bulk packaged.

SPECIFICATIONS SUBJECT TO CHANGE WITHOUT NOTICE.

**US # MJTPSHW**  
Process compatible

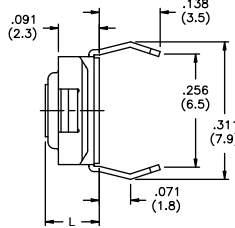

US # Model No.	Dim. L (in./mm)
<b>MJTPSHW</b>	.122 (3,1)
<b>MJTPSHWA</b>	.091 (2,3)
<b>MJTPSHWB</b>	.146 (3,8)

Bulk packaged.

**CAPS** (for MJTP1105T and MJTP1234 only)

**CAPS** (for MJTP1193 only)

**New!**

**CAP COLORS**

**MJ61** Square cap

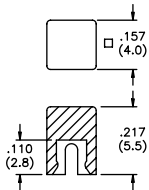

**MJ62** Round cap

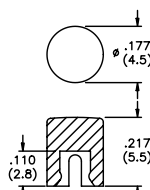

**MJ3** Square cap (w/clear lens in center for LED illumination)

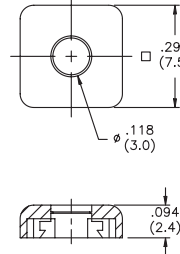

Note - add digit from table to cap part number for color. Example - **MJ612** indicates square black cap.

No.	Color
<b>1</b>	blue
<b>2</b>	black
<b>3</b>	green
<b>5</b>	yellow
<b>6</b>	red
<b>7</b>	ivory

**SCHEMATICS**

MJTP1109  
MJTP1119  
MJTP1193  
MJTP1230  
MJTP1232

MJTP1234  
MJTP2205  
MJTP4102  
MJTP5302  
MJTPSHW

Note: LED is for MJTP1193 only.

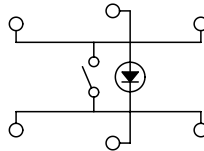

MJTP1105  
MJTP1117  
MJTP1129  
MJTP1141  
MJTP1144  
MJTP1145

MJTP1236  
MJTP1243  
MJTP1250  
MJTP2205  
MJTP4102  
MJTP5302

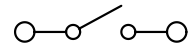

**M**

**PRINTED CIRCUIT BOARD LAYOUTS**

Layout tolerances; Linear: ±.004" (±0,1MM) Holes: ±.002" (±0,05MM)

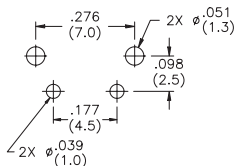

**MJTP1105T**

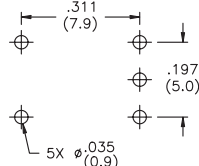

**MJTP1109**

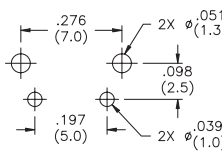

**MJTP1117**

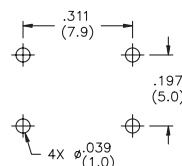

**MJTP1119**

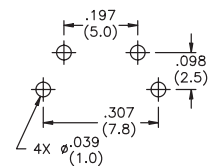

**MJTP1129**

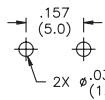

**MJTP1141, 44 & 45**

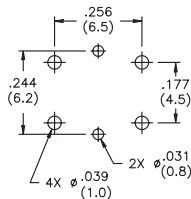

**MJTP1193**

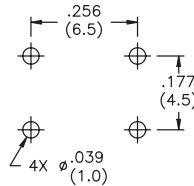

**MJTP1230**

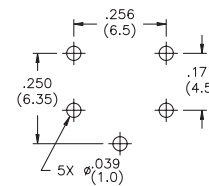

**MJTP1232**

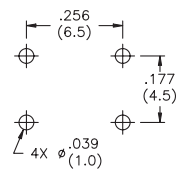

**MJTP1234**

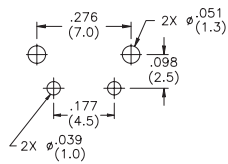

**MJTP1236**

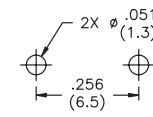

**MJTP1243**

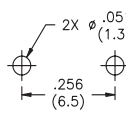

**MJTP1250**

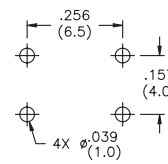

**MJTPSHW**

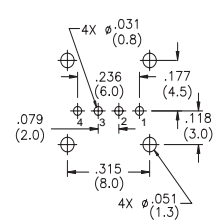

**MJTP2205**

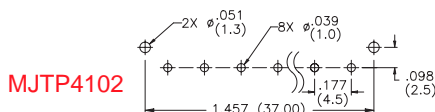

**MJTP4102**

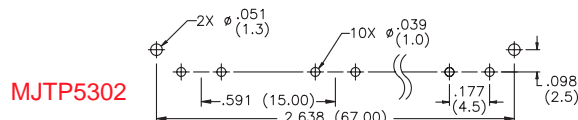

**MJTP5302**



Компания «ЭлектроПласт» предлагает заключение долгосрочных отношений при поставках импортных электронных компонентов на взаимовыгодных условиях!

Наши преимущества:

- Оперативные поставки широкого спектра электронных компонентов отечественного и импортного производства напрямую от производителей и с крупнейших мировых складов;
- Поставка более 17-ти миллионов наименований электронных компонентов;
- Поставка сложных, дефицитных, либо снятых с производства позиций;
- Оперативные сроки поставки под заказ (от 5 рабочих дней);
- Экспресс доставка в любую точку России;
- Техническая поддержка проекта, помощь в подборе аналогов, поставка прототипов;
- Система менеджмента качества сертифицирована по Международному стандарту ISO 9001;
- Лицензия ФСБ на осуществление работ с использованием сведений, составляющих государственную тайну;
- Поставка специализированных компонентов (Xilinx, Altera, Analog Devices, Intersil, Interpoint, Microsemi, Aeroflex, Peregrine, Syfer, Eurofarad, Texas Instrument, Miteq, Cobham, E2V, MA-COM, Hittite, Mini-Circuits, General Dynamics и др.);

Помимо этого, одним из направлений компании «ЭлектроПласт» является направление «Источники питания». Мы предлагаем Вам помощь Конструкторского отдела:

- Подбор оптимального решения, техническое обоснование при выборе компонента;
- Подбор аналогов;
- Консультации по применению компонента;
- Поставка образцов и прототипов;
- Техническая поддержка проекта;
- Защита от снятия компонента с производства.



#### Как с нами связаться

**Телефон:** 8 (812) 309 58 32 (многоканальный)

**Факс:** 8 (812) 320-02-42

**Электронная почта:** [org@eplast1.ru](mailto:org@eplast1.ru)

**Адрес:** 198099, г. Санкт-Петербург, ул. Калинина, дом 2, корпус 4, литера А.