

Encapsulated Quarter-Brick 100-Watt Isolated DC-DC Converter



Output Voltage (V)	Output Current (A)	Input Voltage (V)
5	20	110
12	8.3	110
24	4.2	110

Optimized for harsh environments in industrial/railway applications, the IRQ DC-DC converter series offer regulated outputs in an industry-standard quarter brick fully encased package.

FEATURES

- DC input range: 57.6-160V (Covers both 96V and 110V input range)
- Encapsulated circuitry for optimal thermal/vibration performance
- Regulation: $\pm 0.3\%$ from no load to full load
- High Efficiency
- Maximum baseplate operating temperature: 110°C, full load
- Over-current & Over-temperature protection
- Synchronous rectifier topology
- Stable no-load operation
- Support Pre-Bias startup

SAFETY FEATURES

- Reinforced insulation
- 3000Vdc input to output isolation
- EN 50155
- UL 60950-1 (Pending)
- CAN/CSA-C22.2 No. 60950-1 (Pending)
- EN 60950-1
- RoHS compliant

PRODUCT OVERVIEW

The IRQ series regulated converter module deliver a 5V, 12V or 24V output @ $V_{in} = 57.6 - 160$ Vdc in an industry standard quarter brick fully encased package at astonishing efficiency. The fully isolated (3000Vdc) IRQ series accept a 57.6 to 160 Volt DC input voltage range with a reinforced insulation system. Typical applications include industrial, railway and transportation applications.

The IRQ's synchronous-rectifier topology and fixed frequency operations means excellent efficiencies. A wealth of electronic protection features include input under voltage lockout, over voltage lockout protection, output current limit, current sharing, short circuit hiccup, V_{out} overshoot, and over temperature shutdown.

Available options include various pin lengths and flanged baseplate. The IRQ series is designed to meet all UL and IEC emissions, safety, and flammability certifications.

Slotted / Flanged Baseplate
"V" Option Pins / Pinout
Pin Dia : 0.080

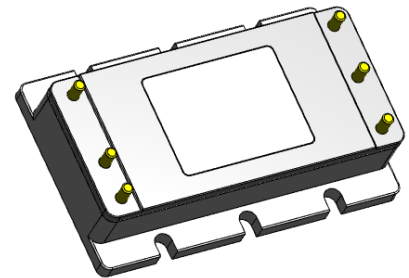

Slotted / Flanged Baseplate
DOSA Pins / Pinout
Pin Dia : 0.040 / 0.060

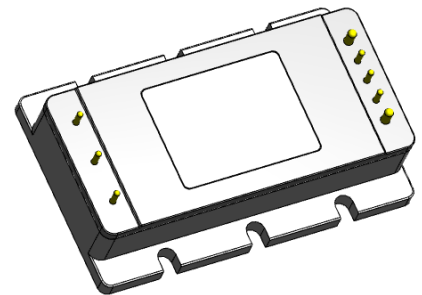

Standard Baseplate
DOSA Pins / Pinout
Pin Dia : 0.040 / 0.060

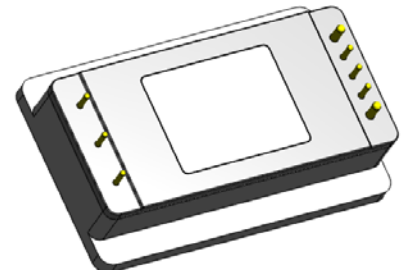

For full details go to
www.murata-ps.com/rohs



PERFORMANCE SPECIFICATIONS SUMMARY AND ORDERING GUIDE ① ②

Root Model ①	Output						Input				Efficiency		
	VOUT (V)	IOUT (A, max)	Total Power (W)	Ripple & Noise (mVp-p)		Regulation (max.)		VIN Nom. (V)	Range (V)	IIN, no load (mA)	IIN, full load (A)	Min.	Typ.
				Typ.	Max.	Line	Load						
IRQ-5/20-T110	5	20	100	80	150	±0.2%	±0.3%	110	57.6-160	150	2.06	83.0%	85.5%
IRQ-12/8.3-T110	12	8.3	100	50	120	±0.6%	±0.5%	110	57.6-160	50	2.50	87.0%	87.4%
IRQ-24/4.2-T110	24	4.2	100	100	240	±0.3%	±0.3%	110	57.6-160	20	2.50	86.5%	88.2%

① Please refer to the part number structure for additional options and complete ordering part numbers.

② All specifications are at nominal line voltage and full load, +25 °C. Unless otherwise noted. See detailed specifications. Output capacitors are 1 µF ceramic in parallel with 10 µF electrolytic. I/O caps are necessary for our test equipment and may not be needed for your application.

Part Number Structure

IR X - Vout / Iout - Input Voltage N V F - C

- Industrial-Railway** (IR)
- Package** (X)
 - Q = Quarter Brick
- Nominal Output Voltage** (Vout / Iout)
 - 5 = 5Vout
 - 12 = 12Vout
 - 24 = 24Vout
- Maximum Rated Output Current** (Iout)
 - Amps
- Input Voltage Range** (Input Voltage)
 - T110 = 57.6 - 160V (110V Nominal)
- On/Off Control Logic** (N)
 - N = Negative Logic (Standard with Pin Option #2)
 - P = Positive Logic (Standard with Pin Option #1-V)
- Pin Options** (V)
 - V = Option #1, V Option Pins/Pinout
 - Please see mechanical drawings for V Option
 - Blank = Option #2 (DOSA)
- Package/Cooling Configuration** (F)
 - Blank = Standard Baseplate (Not available with Pin Option #1 V, Please see mechanical drawings for details)
 - F = Slotted/Flanged Baseplate (Please see mechanical drawings for details)
- RoHS-Compliant** (C)

Examples: IRQ-5/20-T110N-C stands for Industrial Rail Quarter Brick, 5Vout @ 20A, 57.6V - 160Vin, Negative Logic, Option #2 Pin Option, Standard Baseplate, RoHS Compliant. IRQ-5/20-T110PVF-C stands for Industrial Rail Quarter Brick, 5Vout @ 20A, 57.6V - 160Vin, Positive Logic, V Pin option with Slotted / Flanged Baseplate, RoHS Compliant.

Note: Please see mechanical drawings for details. Special order applies to Positive Logic version. Some model number combinations may not be available. See website or contact your local Murata sales representative.

IRQ SERIES FUNCTIONAL SPECIFICATIONS

ABSOLUTE MAXIMUM RATINGS	Conditions	Minimum	Typical/Nominal	Maximum	Units
Input Voltage, Continuous		0		160	Vdc
Input Voltage, Transient	100 mS max. duration			170	Vdc
Isolation Voltage	Input to output			3000	Vdc
	Input to Baseplate			1500	Vdc
	Output to Baseplate			500	Vdc
On/Off Remote Control	Referred to -Vin	0		15	Vdc
Operating Temperature Range	Ambient Temperature	-40		85	°C
Storage Temperature Range	Baseplate Temperature	-55		125	°C

Absolute maximums are stress ratings. Exposure of devices to greater than any of these conditions may adversely affect long-term reliability. Proper operation under conditions other than those listed in the Performance/Functional Specifications Table is not implied nor recommended.

INPUT

Operating Input Voltage Range		0		160	Vdc
Turn-on Voltage Threshold		52	54.5	57	Vdc
Turn-off Voltage Threshold		50	52	56	Vdc
Lockout Voltage Hysteresis			TBD		Vdc
Recommended External Input Capacitance			TBD		uF

FEATURES and OPTIONS

	Conditions	Minimum	Typical/Nominal	Maximum	Units
Primary On/Off control (designed to be driving with an open collector logic, Voltages referenced to -Vin)					
"P" suffix:					
Positive Logic, ON state	ON = pin open or external voltage	3.5		15	V
Positive Logic, OFF state	OFF = ground pin or external voltage	0		1	V
Control Current	open collector/drain		1	2	mA
"N" suffix:					
Negative Logic, ON state	ON = ground pin or external voltage	-0.1		0.8	V
Negative Logic, OFF state	OFF = pin open or external voltage	2.5		15	V
Control Current	open collector/drain		1	2	mA
Remote Sense Compliance	Sense pins connected externally to respective Vout pins		5		%

ENVIRONMENTAL

Operating Ambient Temperature	Ambient Temperature	-40		85	°C
	Baseplate Temperature	-40		110	°C
Storage Temperature		-55		125	°C
Semiconductor Junction Temperature				125	°C
Thermal Protection	Average PCB Temperature		125		°C
Thermal Protection Restart Hysteresis					°C
Electromagnetic Interference	External filter required; see Emissions performance test.		B		Class
Conducted, EN55022/CISPR22					
RoHS rating			RoHS-6		

IRQ SERIES FUNCTIONAL SPECIFICATIONS

GENERAL and SAFETY					
Insulation Safety Rating			Reinforced		
Isolation Resistance		10			MΩ
Isolation Capacitance				500	pF
Safety	Certified to UL-60950-1, CSA-C22.2 No.60950-1, IEC/EN60950-1, 2nd edition (pending)		Yes		
MECHANICAL	Conditions	Minimum	Typical/Nominal	Maximum	Units
Through Hole Pin Diameter	Standard:Option#2		0.06 & 0.04		Inches
			1.524 & 1.016		mm
	Option#1		0.08		Inches
			2.032		mm
Through Hole Pin Material			Copper alloy		
TH Pin Plating Metal and Thickness	Nickel subplate		98.4-299		μ-inches
	Gold overplate		4.7-19.6		μ-inches

Preliminary

FUNCTIONAL SPECIFICATIONS (IRQ-5/20-T110)

INPUT	Conditions	Minimum	Typical/Nominal	Maximum	Units
Input current					
Full Load Conditions	Vin = nominal		1.06	1.11	A
Low Line input current	Vin = minimum		2.01	2.06	A
Inrush Transient	Vin = 110v		0.1	0.2	A ² -Sec.
Short Circuit input current			0.1	0.2	A
No Load input current	Iout = minimum, unit=ON		50	150	mA
Shut-Down input current (Off, UV, OT)			15	30	mA
Back Ripple Current	Measured at the input of module with a simulated source impedance of 12μH, 220μF, 450V, across source, 33μF, 250V external capacitors across input pins.			2000	mAp-p
Internal Filter Type/Value			Pi		
Recommended Input fuse				5	A
OUTPUT					
Total Output Power		0	100	101	W
Voltage					
Setting Accuracy	At 100% load, no trim, all conditions	4.95	5	5.05	Vdc
Output Adjust Range		4.950		5.050	Vdc
Overvoltage Protection		6	6.3	6.5	Vdc
Current					
Output Current Range		0	20	20	A
Minimum Load			0		
Current Limit Inception	cold condition	22	25	30	A
Short Circuit					
Short Circuit Current	Hiccup technique - Auto recovery within 1.25% of Vout		2.0	4.0	A
Short Circuit Duration (remove short for recovery)	Output shorted to ground, no damage		Continuous		
Short circuit protection method	Hiccup current limiting		Non-latching		
Regulation					
Line Regulation	Vin = 57.6-160, Vout = nom., full load			±0.2	%
Load Regulation	Iout = min. to max., Vin = nom.			±0.3	%
Ripple and Noise	20 MHz BW, Cout = 1μF		80	150	mV pk-pk
	paralleled with 10μF				
Temperature Coefficient	At all outputs		0.02		% of Vnom./°C
Maximum Output Capacitance	(Loads : CR mode)			3300	μF
	(Loads : CC mode)			3300	μF
GENERAL and SAFETY					
Efficiency	Vin=110V, full load	83	85.5		%

FUNCTIONAL SPECIFICATIONS (IRQ-5/20-T110)

Isolation Resistance		10			MΩ
Isolation Capacitance				500	pF
Calculated MTBF	Per Telcordia SR-332, Issue 2, Method 1, Class 1, Ground Fixed, Tcase=+25°C		1800		Hours x 10 ³
DYNAMIC CHARACTERISTICS					
Switching Frequency			200		KHz
Turn On Time					
Vin On to Vout Regulated			20	30	mS
Remote On to Vout Regulated			TBD	TBD	mS
Vout Rise Time					
From 0%~100%			15	30	mS
Dynamic Load Response	50-75-50%, 1A/us, within 1% of Vout			50	µSec
Dynamic Load Peak Deviation	same as above		±100	±300	mV
MECHANICAL	Conditions	Minimum	Typical/Nominal	Maximum	Units
Outline Dimensions (with baseplate)			2.28x 1.45 x 0.5		Inches
			57.91x36.83x 12.7		mm
Weight (with baseplate)			2.23		Ounces
			63.6		Grams

PERFORMANCE DATA (IRQ-5/20-T110)

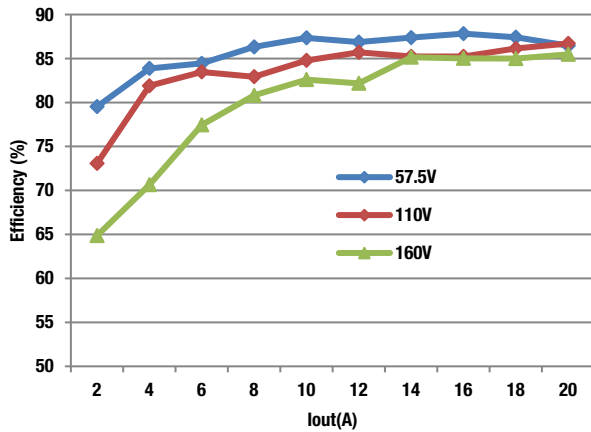

Efficiency vs. Load Current

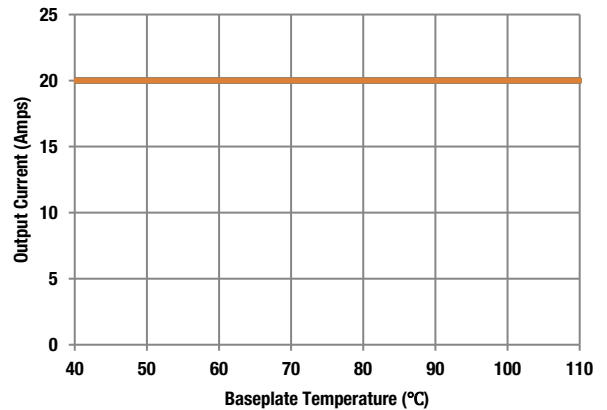

Thermal Derating vs. Baseplate temperature

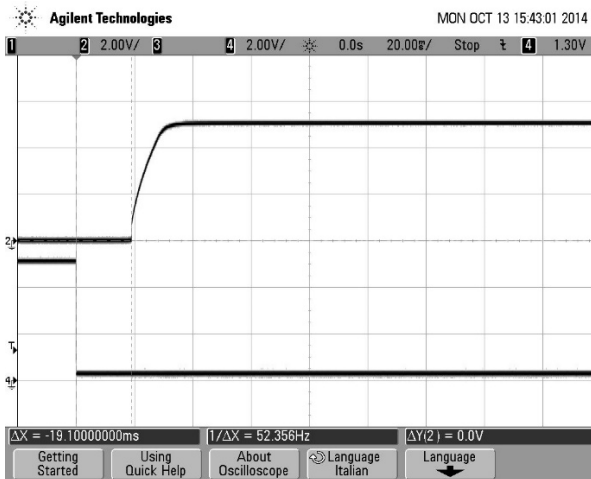

Turn-on transient at zero load current
(20 mS/div, Top Trace: Vout, 2V/div; Bottom Trace: ON/OFF, 2V/div)

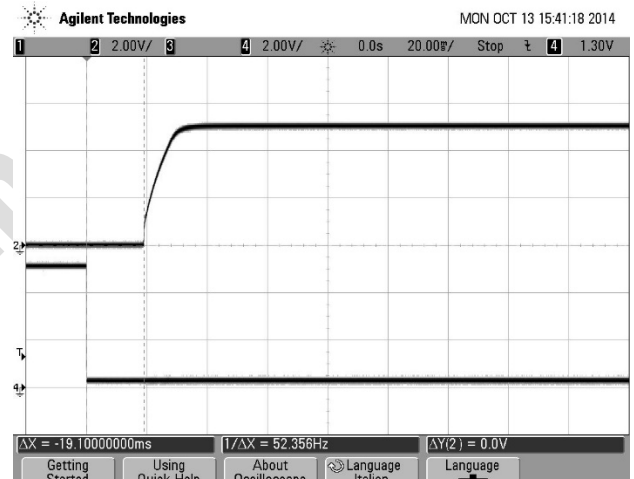

Turn-on transient at full load current
(20 mS/div, Top Trace: Vout, 2V/div; Bottom Trace: ON/OFF, 2V/div)

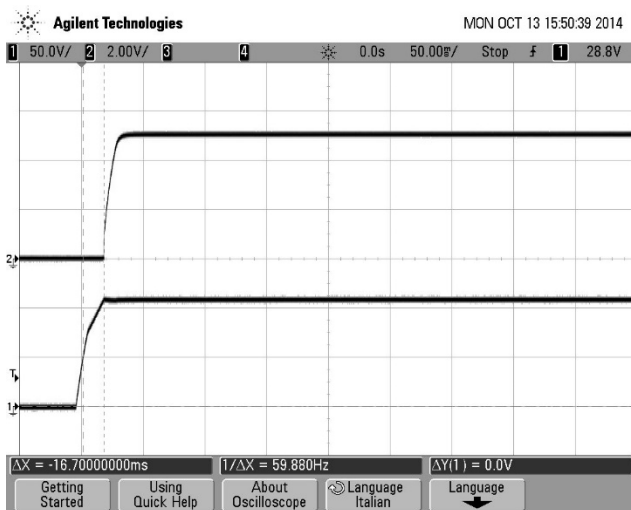

Turn-on transient at zero load current
(50 mS/div, Top Trace: Vout, 2V/div; Bottom Trace: Vin, 50V/div)

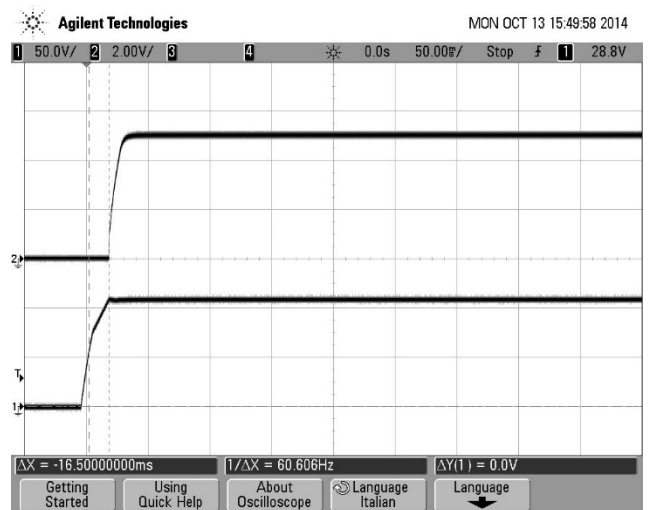

Turn-on transient at full load current
(50 mS/div, Top Trace: Vout, 2V/div; Bottom Trace: Vin, 50V/div)

PERFORMANCE DATA (IRQ-5/20-T110)

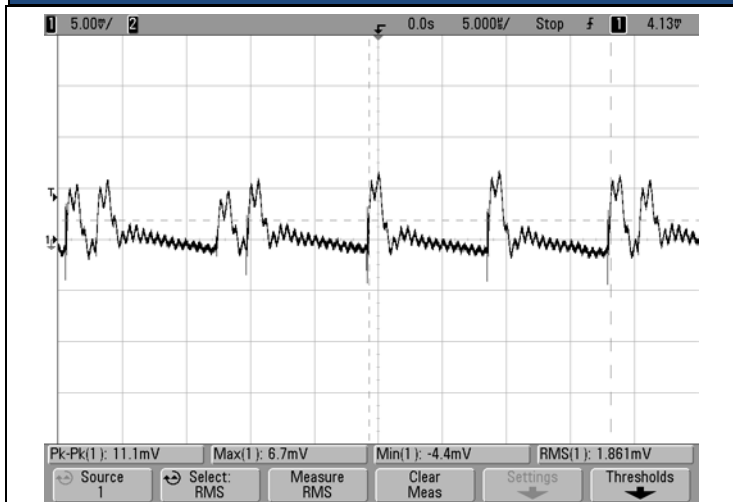

Ripple and Noise @25°C
(Vin = 110V, Vout = nom., Iout = 0, Clload = 0, ScopeBW = 20MHz)

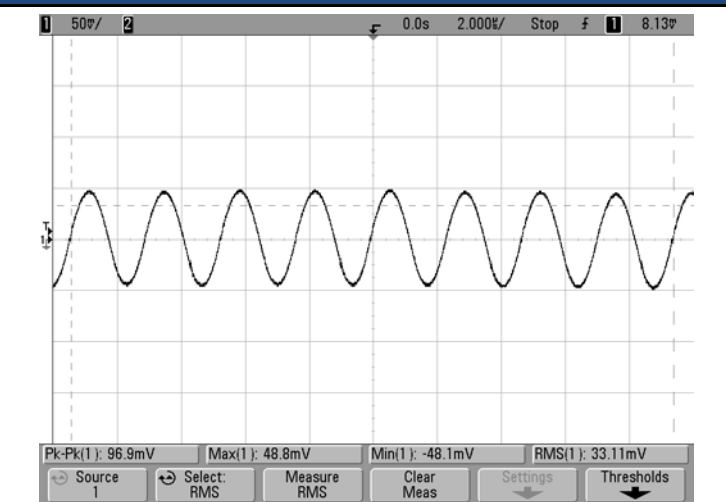

Ripple and Noise @25°C
(Vin = 110V, Vout = nom., Iout = 20A, Clload = 0, ScopeBW = 20MHz)

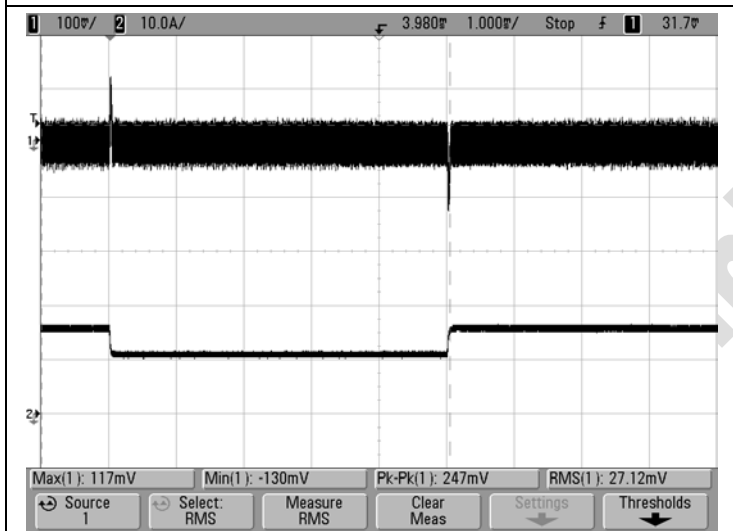

Step Load Transient Response@25°C
(Vin = 110V, Vout = nom., Iout = 75-50-75% of full load, Clload = 0µF, ScopeBW = 20MHz)

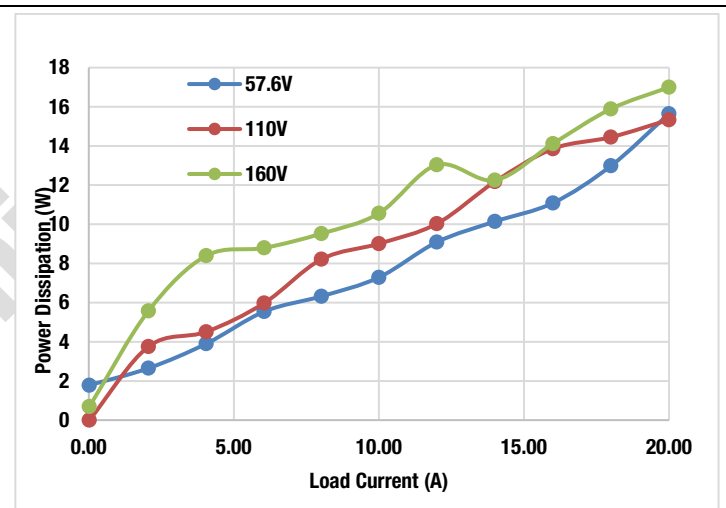

Power Dissipation vs. Load Current @25°C

Thermal Derating (IRQ-5/20-T110, Unit mounted on a 10 X 10 inch PCB)

TRANSVERSE (AIRFLOW FROM Vin- TO Vin+)

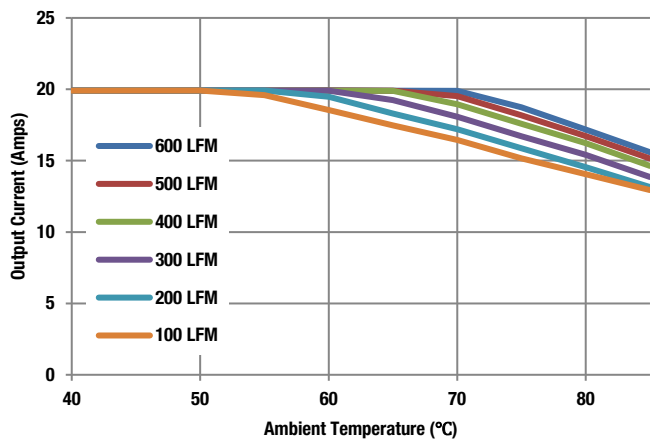

Maximum Current Temperature Derating (Vin = 57.6V)

LONGITUDINAL (AIRFLOW FROM Vin TO Vout)

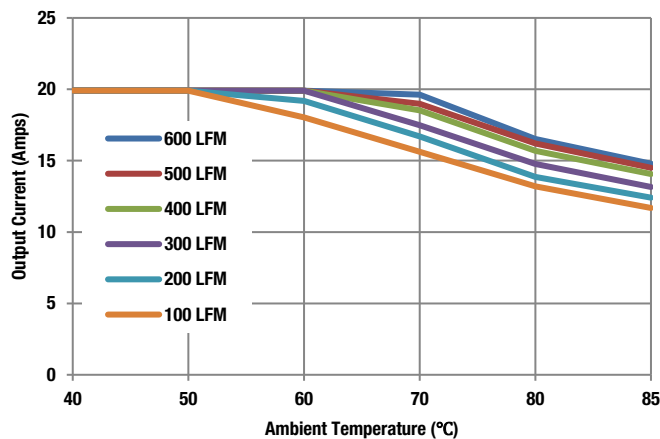

Maximum Current Temperature Derating (Vin = 57.6V)

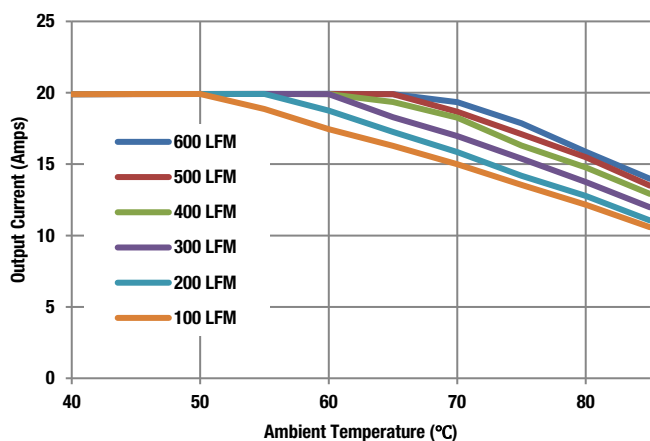

Maximum Current Temperature Derating (Vin = 110V)

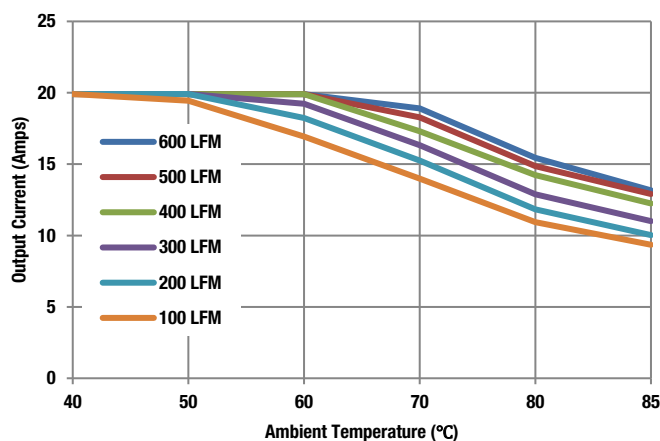

Maximum Current Temperature Derating (Vin = 110V)

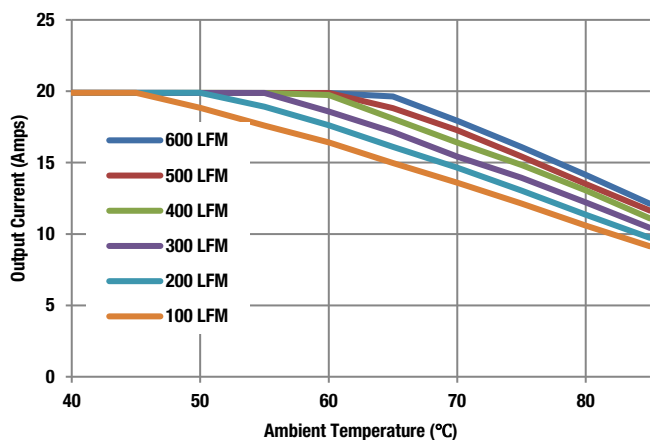

Maximum Current Derating (Vin = 160V)

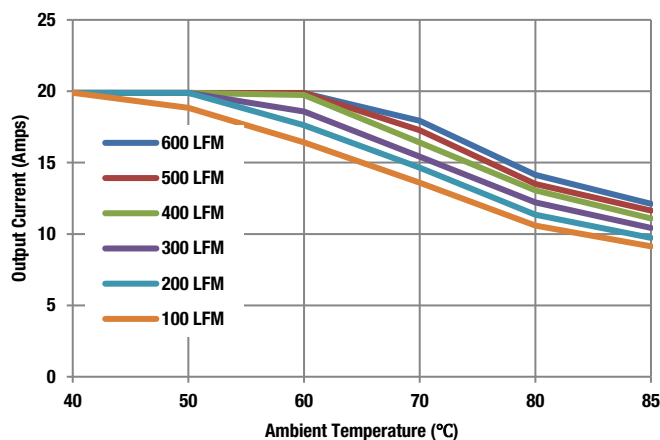

Maximum Current Derating (Vin = 160V)

FUNCTIONAL SPECIFICATIONS (IRQ-12/8.3-T110)

INPUT	Conditions	Minimum	Typical/Nominal	Maximum	Units
Input current					
Full Load Conditions	Vin = nominal		1.00	1.50	A
Low Line input current	Vin = minimum		1.98	2.50	A
Inrush Transient	Vin = 110v		0.1	0.2	A ² -Sec.
Short Circuit input current			0.02	0.05	A
No Load input current	Iout = minimum, unit=ON		7	50	mA
Shut-Down input current (Off, UV, OT)			5	50	mA
Back Ripple Current	Measured at the input of module with a simulated source impedance of 12μH, 220μF, 450V, across source, 33μF, 250V external capacitors across input pins.			600	mAp-p
Internal Filter Type/Value			Pi		
Recommended Input fuse				10	A
OUTPUT					
Total Output Power		0	99.60	100.60	W
Voltage					
Setting Accuracy	At 100% load, no trim, all conditions	11.88	12	12.12	Vdc
Output Adjust Range		10.8		13.2	Vdc
Overvoltage Protection		14	16	18	Vdc
Current					
Output Current Range		0	8.30	8.30	A
Minimum Load			0		
Current Limit Inception	cold condition	9.13	10.50	12.45	A
Short Circuit					
Short Circuit Current	Hiccup technique - Auto recovery within 1.25% of Vout		1.4	3	A
Short Circuit Duration (remove short for recovery)	Output shorted to ground, no damage		Continuous		
Short circuit protection method	Hiccup current limiting		Non-latching		
Regulation					
Line Regulation	Vin = 57.6-160, Vout = nom., full load			±0.6	%
Load Regulation	Iout = min. to max., Vin = nom.			±0.5	%
Ripple and Noise	20 MHz BW, Cout = 1μF		50	120	mV pk-pk
	paralleled with 10μF				
Temperature Coefficient	At all outputs			0.02	% of Vnom./°C
Maximum Output Capacitance	(Loads : CR mode)			1000	μF
	(Loads : CC mode)			1000	μF
GENERAL and SAFETY					
Efficiency	Vin=110V, full load	87	87.4		%

FUNCTIONAL SPECIFICATIONS (IRQ-12/8.3-T110)

Isolation Resistance			10		MΩ
Isolation Capacitance			500		pF
Calculated MTBF	Per Telcordia SR-332, Issue 2, Method 1, Class 1, Ground Fixed, Tcase=+25°C		1800		Hours x 10 ³
DYNAMIC CHARACTERISTICS					
Switching Frequency			200		KHz
Turn On Time					
Vin On to Vout Regulated			18	30	mS
Remote On to Vout Regulated			TBD	TBD	mS
Vout Rise Time					
From 0%~100%			10	25	mS
Dynamic Load Response	50-75-50%, 1A/us, within 1% of Vout		400	600	μSec
Dynamic Load Peak Deviation	same as above		±200	±300	mV
MECHANICAL	Conditions	Minimum	Typical/Nominal	Maximum	Units
Outline Dimensions (with baseplate)			2.28x 1.45 x 0.50		Inches
			57.91x36.83x 12.7		mm
Weight (with baseplate)			2.23		Ounces
			63.6		Grams

PERFORMANCE DATA (IRQ-12/8.3-T110)

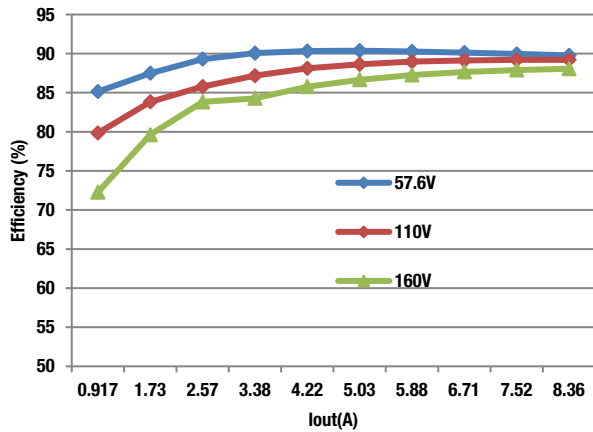

Efficiency vs. Load Current

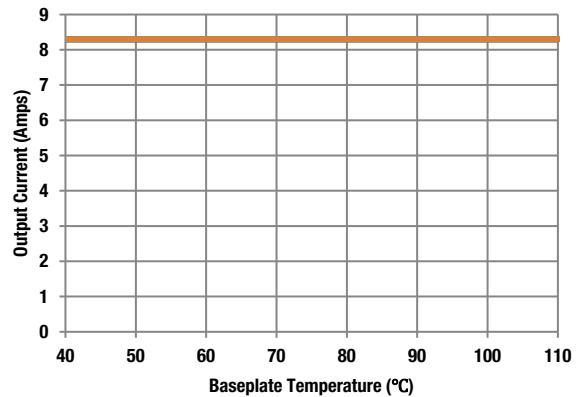

Thermal Derating vs. Baseplate temperature



Turn-on transient at zero load current
(10 mS/div, Top Trace: Vout, 5V/div; Bottom Trace: ON/OFF, 2V/div)



Turn-on transient at full load current
(10 mS/div, Top Trace: Vout, 5V/div; Bottom Trace: ON/OFF, 2V/div)

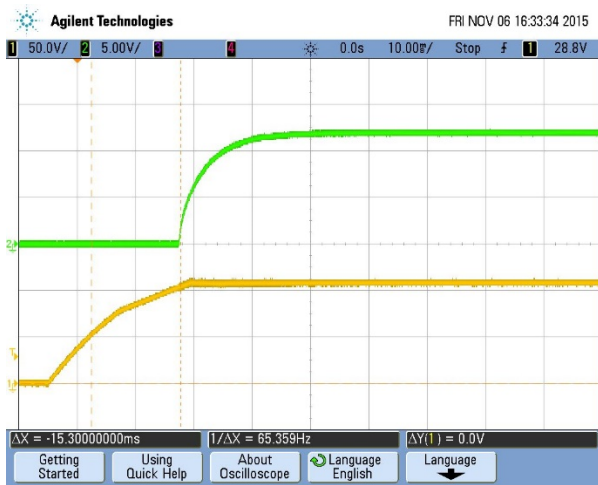

Turn-on transient at zero load current
(10 mS/div, Top Trace: Vout, 5V/div; Bottom Trace: Vin, 50V/div)

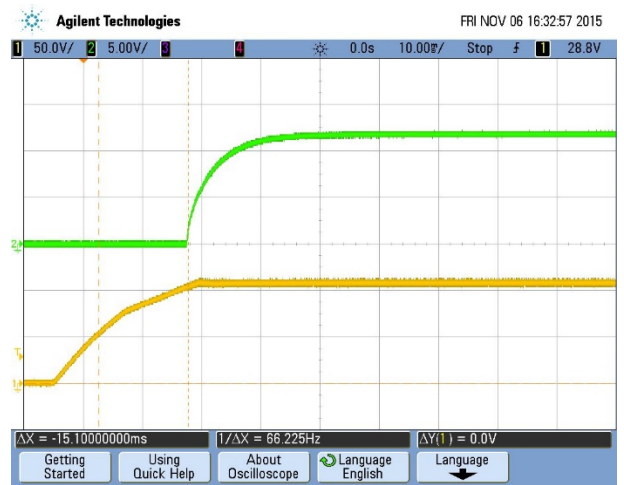

Turn-on transient at full load current
(10 mS/div, Top Trace: Vout, 5V/div; Bottom Trace: Vin, 50V/div)

PERFORMANCE DATA (IRQ-12/8.3-T110)

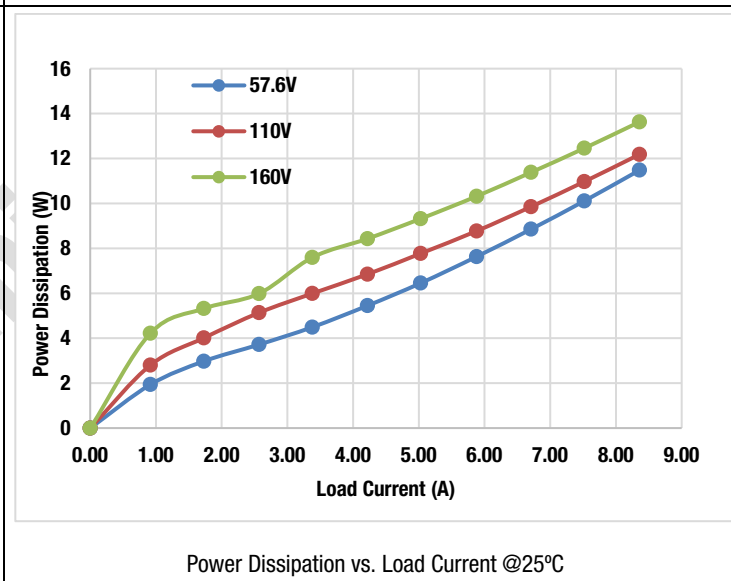
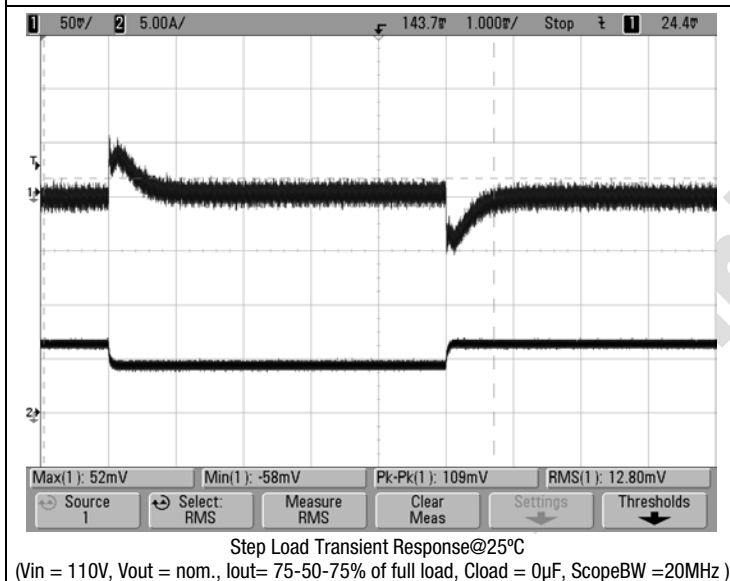
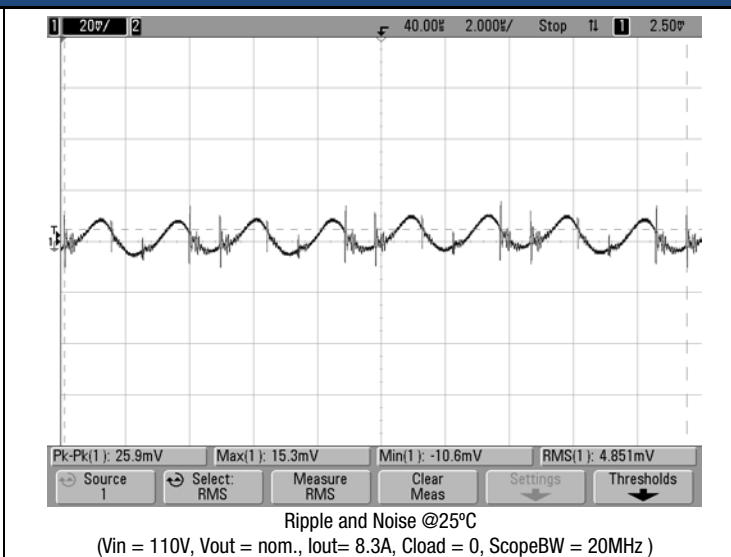
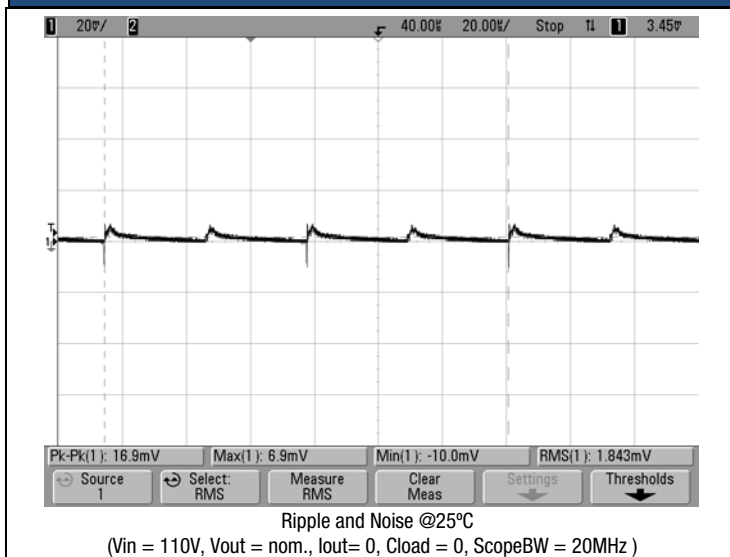

Thermal Derating (IRQ-12/8.3-T110, Unit mounted on a 10 X 10 inch PCB)

TRANSVERSE (AIRFLOW FROM Vin- TO Vin+)

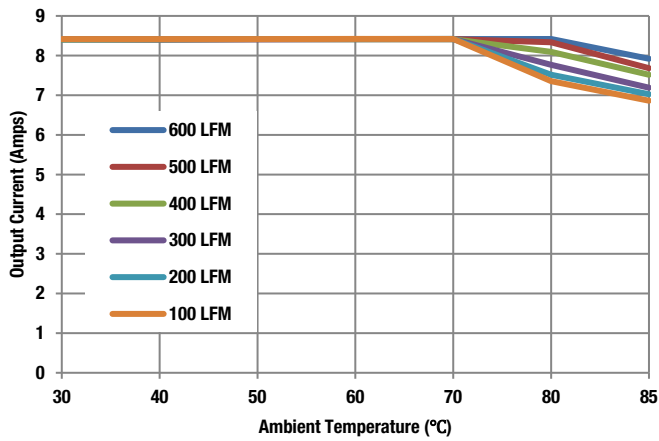

Maximum Current Temperature Derating (Vin = 57.6V)

LONGITUDINAL (AIRFLOW FROM Vin TO Vout)

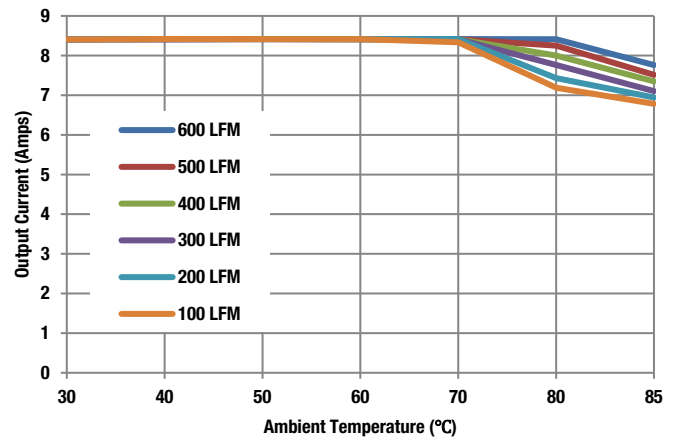

Maximum Current Temperature Derating (Vin = 57.6V)

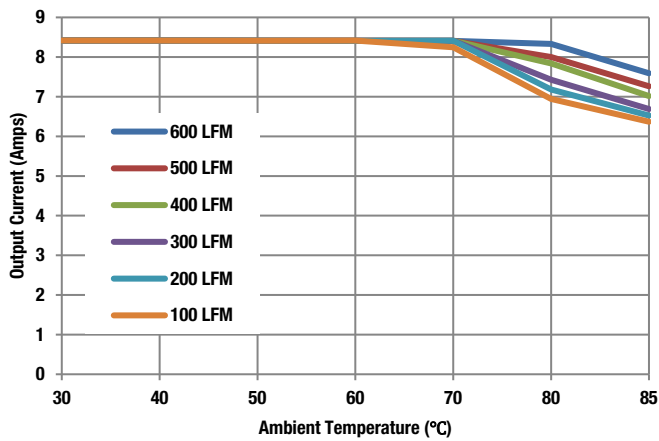

Maximum Current Temperature Derating (Vin = 110V)

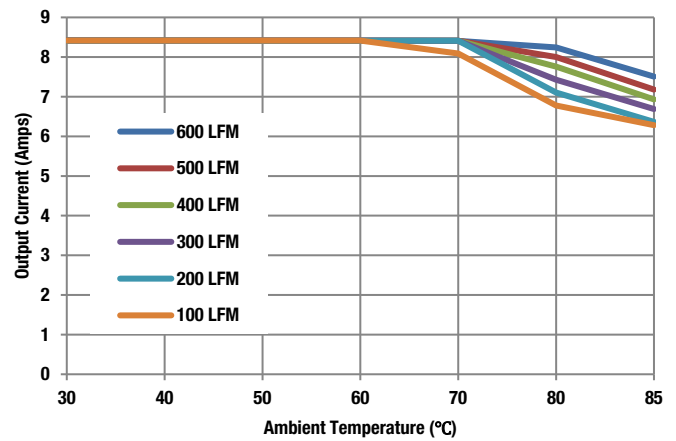

Maximum Current Temperature Derating (Vin = 110V)

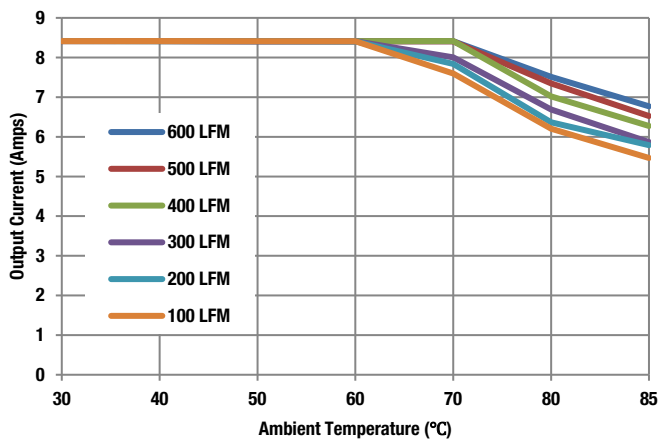

Maximum Current Derating (Vin = 160V)

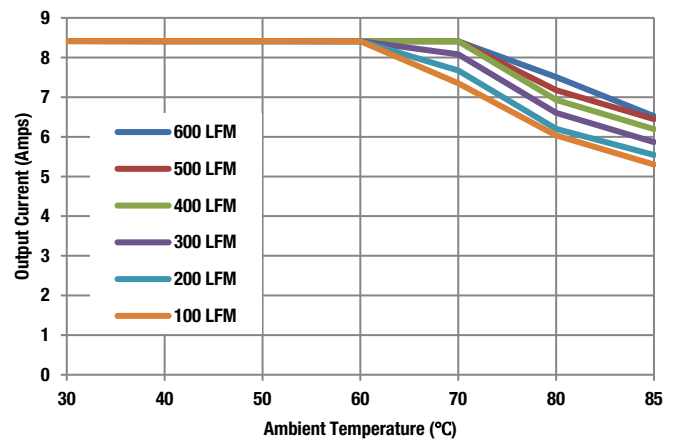

Maximum Current Derating (Vin = 160V)

FUNCTIONAL SPECIFICATIONS (IRQ-24/4.2-T110)

INPUT	Conditions	Minimum	Typical/Nominal	Maximum	Units
INPUT					
Input Current					
Full Load Conditions	Vin = nominal		1.00	1.50	A
Low Line input current	Vin = minimum		2.02	2.50	A
Inrush Transient	Vin = 110v		0.1	0.2	A ² -Sec.
Short Circuit input current			0.03	0.05	A
No Load input current	Iout = minimum, unit=ON		7	20	mA
Shut-Down input current (Off, UV, OT)			5	20	mA
Back Ripple Current	Measured at the input of module with a simulated source impedance of 12μH, 220μF, 450V, across source, 33μF, 250V external capacitors across input pins.			500	mAp-p
Internal Filter Type/Value			Pi		
Recommended Input fuse				10	A
OUTPUT					
Total Output Power		0	100.80	101.81	W
Voltage					
Setting Accuracy	At 100% load, no trim, all conditions	23.76	24	24.24	Vdc
Output Adjust Range		21.6		26.4	Vdc
Overvoltage Protection		28.8	32	36	Vdc
Current					
Output Current Range		0	4.20	4.20	A
Minimum Load			0		
Current Limit Inception	cold condition	4.62	5.67	6.30	A
Short Circuit					
Short Circuit Current	Hiccup technique - Auto recovery within 1.25% of Vout		1.4	3	A
Short Circuit Duration (remove short for recovery)	Output shorted to ground, no damage		Continuous		
Short circuit protection method	Hiccup current limiting		Non-latching		
Regulation					
Line Regulation	Vin = 57.6-160, Vout = nom., full load			±0.2	%
Load Regulation	Iout = min. to max., Vin = nom.			±0.3	%
Ripple and Noise	20 MHz BW, Cout = 1μF		100	240	mV pk-pk
	paralleled with 10μF				
Temperature Coefficient	At all outputs			0.02	% of Vnom./°C
Maximum Output Capacitance	(Loads : CR mode)			560	μF
	(Loads : CC mode)			560	μF
GENERAL and SAFETY					
Efficiency	Vin=110V, full load	86.5	88.2		%

FUNCTIONAL SPECIFICATIONS (IRQ-24/4.2-T110)

Isolation Resistance			10		MΩ
Isolation Capacitance			500		pF
Calculated MTBF	Per Telcordia SR-332, Issue 2, Method 1, Class 1, Ground Fixed, Tcase=+25°C		1800		Hours x 10 ³
DYNAMIC CHARACTERISTICS					
Switching Frequency			200		KHz
Turn On Time					
Vin On to Vout Regulated			18	30	mS
Remote On to Vout Regulated			TBD	TBD	mS
Vout Rise Time					
From 0%~100%			10	25	mS
Dynamic Load Response	50-75-50%, 1A/us, within 1% of Vout		300	500	μSec
Dynamic Load Peak Deviation	same as above		±400	±600	mV
MECHANICAL	Conditions	Minimum	Typical/Nominal	Maximum	Units
Outline Dimensions (with baseplate)			2.28x 1.45 x 0.5		Inches
			57.91x36.83x 12.7		mm
Weight (with baseplate)			2.23		Ounces
			63.6		Grams

PERFORMANCE DATA (IRQ-24/4.2-T110)

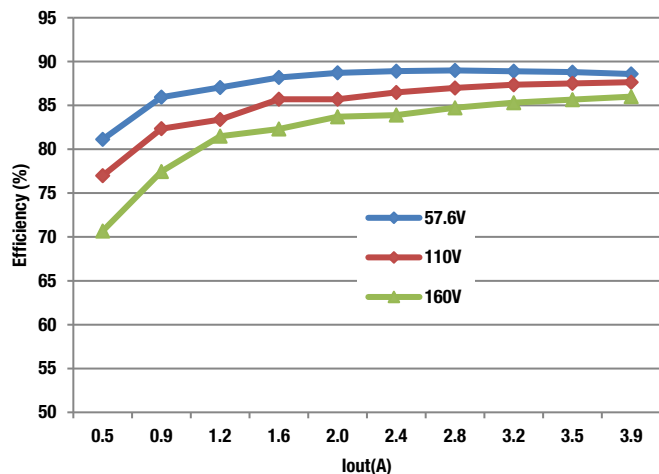

Efficiency vs. Load Current

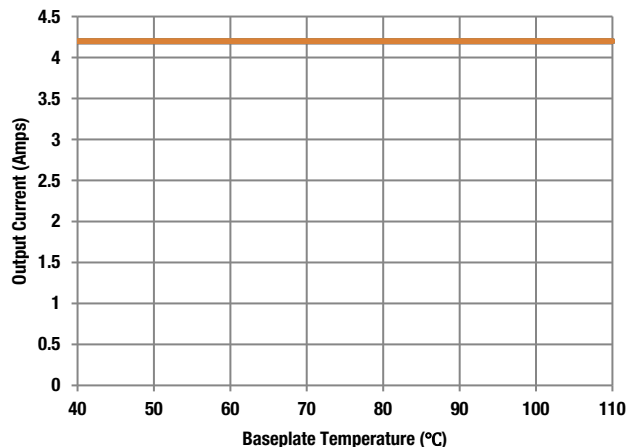

Thermal Derating vs. Baseplate temperature



Turn-on transient at zero load current
(10 mS/div, Top Trace: Vout, 10V/div; Bottom Trace: ON/OFF, 2V/div)



Turn-on transient at full load current
(10 mS/div, Top Trace: Vout, 10V/div; Bottom Trace: ON/OFF, 2V/div)

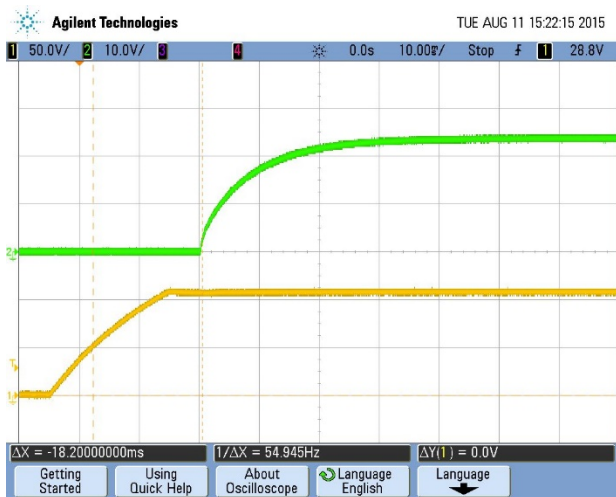

Turn-on transient at zero load current
(10 mS/div, Top Trace: Vout, 10V/div; Bottom Trace: Vin, 50V/div)



Turn-on transient at full load current
(10 mS/div, Top Trace: Vout, 10V/div; Bottom Trace: Vin, 50V/div)

PERFORMANCE DATA (IRQ-24/4.2-T110)

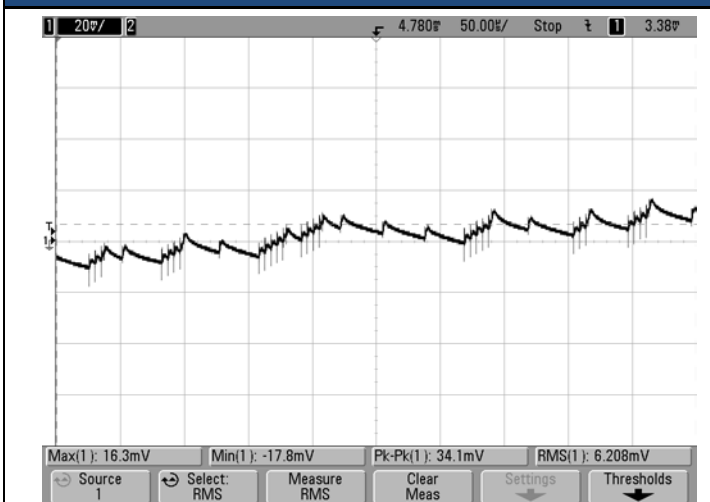

Ripple and Noise @25°C
(Vin = 110V, Vout = nom., Iout= 0, Cload = 0, ScopeBW = 20MHz)

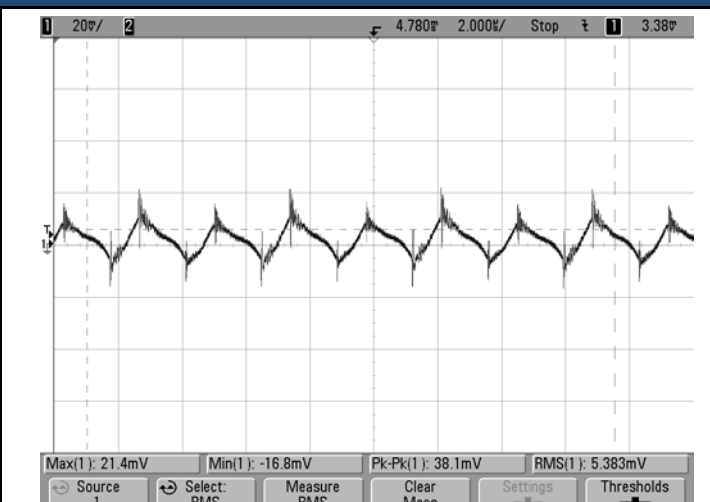

Ripple and Noise @25°C
(Vin = 110V, Vout = nom., Iout= 4.2A, Cload = 0, ScopeBW = 20MHz)

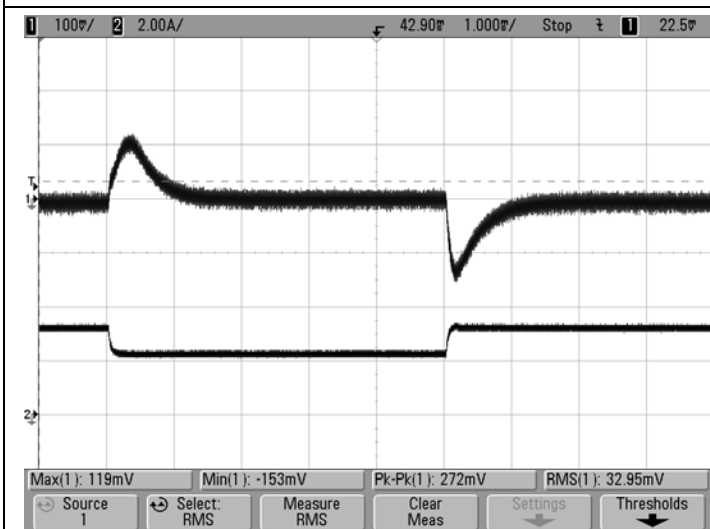

Step Load Transient Response@25°C
(Vin = 110V, Vout = nom., Iout= 75-50-75% of full load, Cload = 0µF, ScopeBW =20MHz)

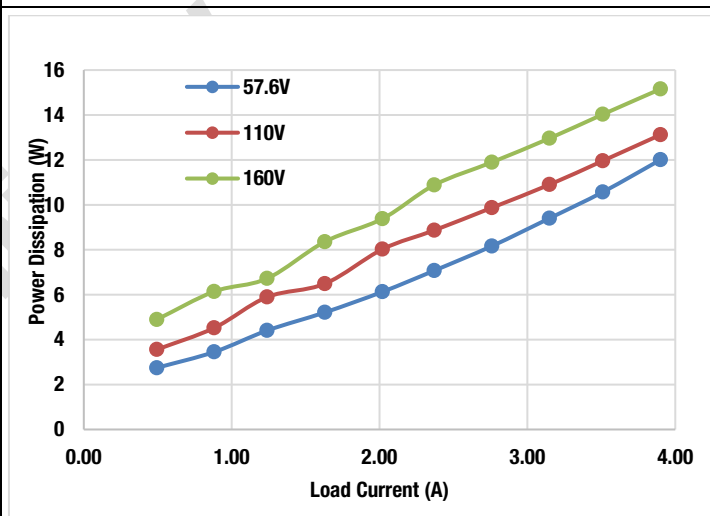

Power Dissipation vs. Load Current @25°C

Thermal Derating (IRQ-24/4.2-T110, Unit mounted on a 10 X 10 inch PCB)

TRANSVERSE (AIRFLOW FROM Vin- TO Vin+)

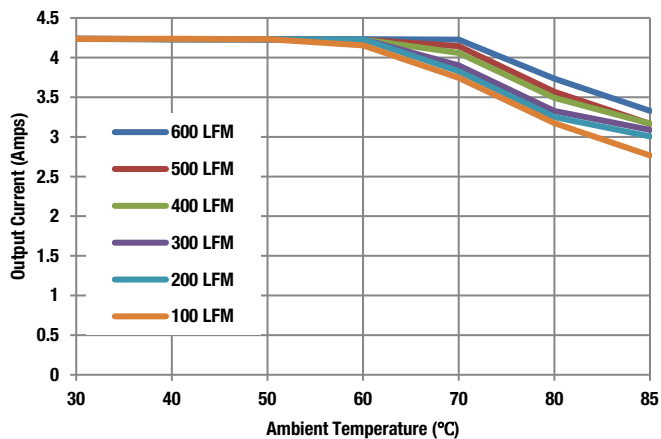

Maximum Current Temperature Derating (Vin = 57.6V)

LONGITUDINAL (AIRFLOW FROM Vin TO Vout)

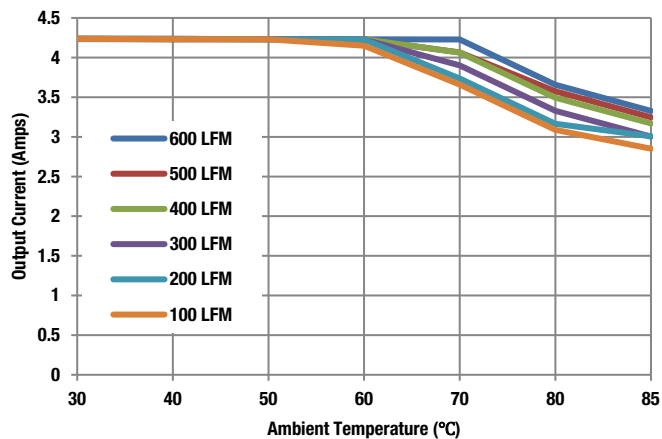

Maximum Current Temperature Derating (Vin = 57.6V)

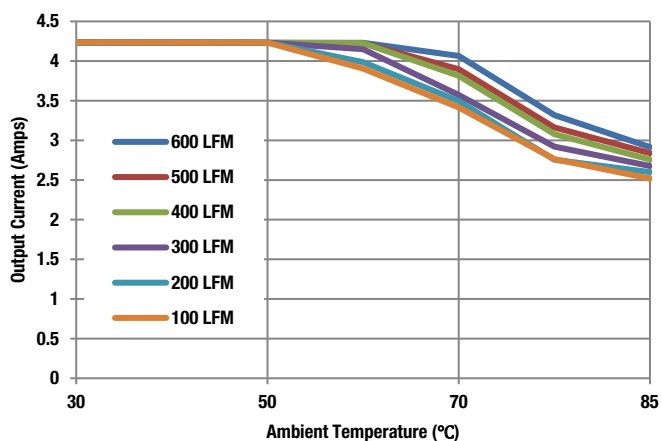

Maximum Current Temperature Derating (Vin = 110V)

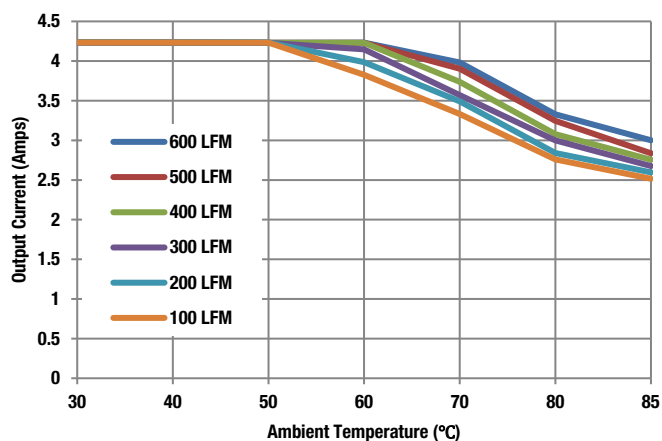

Maximum Current Temperature Derating (Vin = 110V)

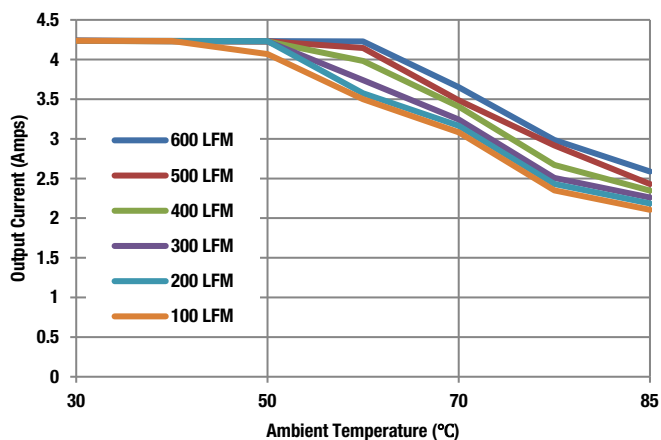

Maximum Current Derating (Vin = 160V)

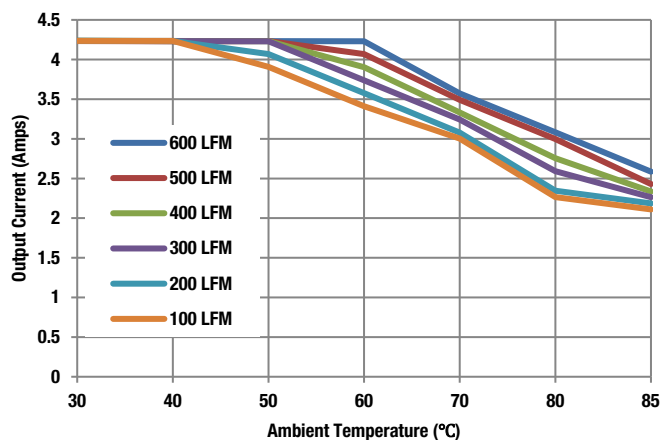

Maximum Current Derating (Vin = 160V)

MECHANICAL SPECIFICATIONS

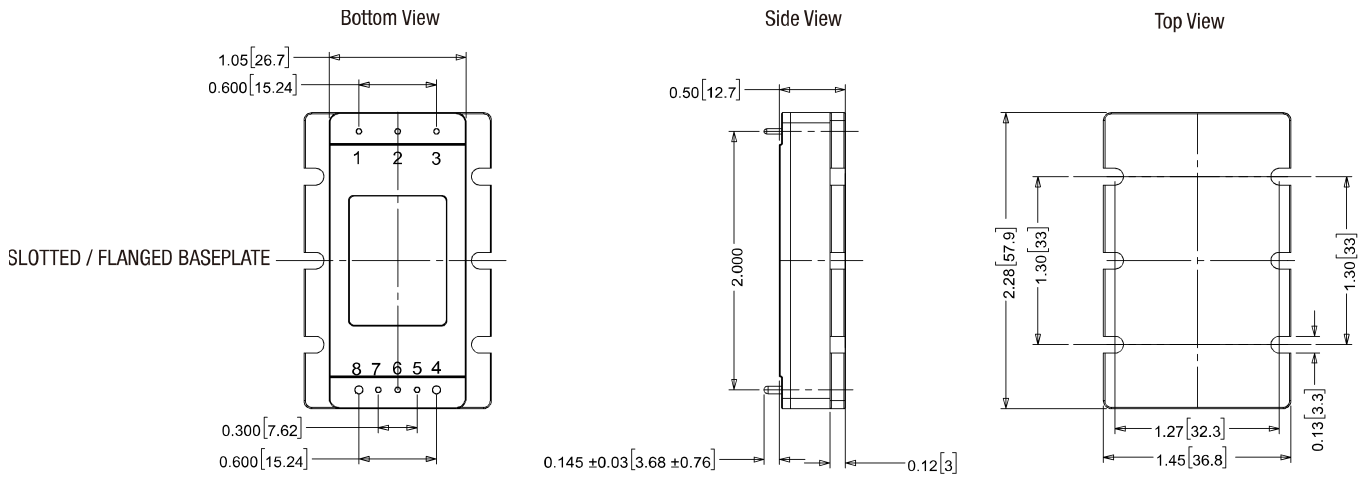

Pin Option#2:
Pin 1-3,5-7: Dia 0.040
Pin 4,8: Dia 0.060

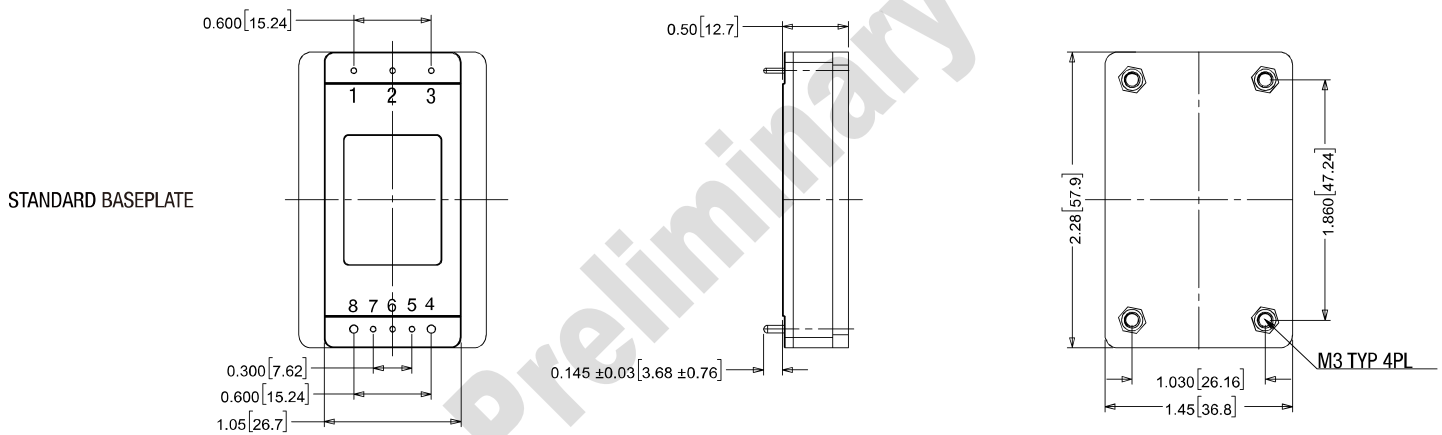

- NOTES:
UNLESS OTHERWISE SPECIFIED:
1:M3 SCREW USED TO BOLT UNIT'S BASEPLATE TO OTHER SURFACES(SUCH AS HEATSINK) MUST NOT EXCEED 0.100"(2.5mm) DEPTH BELOW THE SURFACE OF BASEPLATE
2:APPLIED TORQUE PER SCREW SHOULD NOT EXCEED 5.3In-lb(0.6Nm);
3:ALL DIMENSION ARE IN INCHES[MILIMETER];
4:ALL TOLERANCES: .x.x×in ,±0.02in(x.x×mm,±0.5mm)
x.x××in ,±0.01in(x.x×mm,±0.25mm)

Material:
Pin 1-3,5-7: Dia 0.040 PINS: COPPER ALLOY
Pin 4,8: Dia 0.060 PINS: COPPER ALLOY
FINISH:(ALL PINS)
GOLD(5 u"MIN) OVER NICKEL (100u"MIN)

Dimensions are in inches (mm) shown for ref. only.

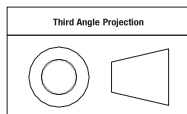

Tolerances (unless otherwise specified):
.XX ± 0.02 (0.5)
.XXX ± 0.010 (0.25)
Angles ± 2°

INPUT/OUTPUT CONNECTIONS

Pin	Function
1	Vin(+)
2	On/Off Control
3	Vin(-)
4	Vout(-)
5	Sense(-)
6	Trim
7	Sense(+)
8	Vout(+)

MECHANICAL SPECIFICATIONS

Bottom View

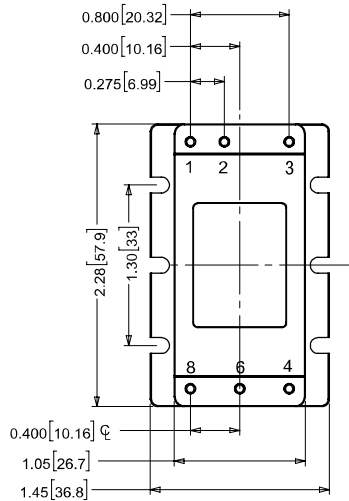

Side View

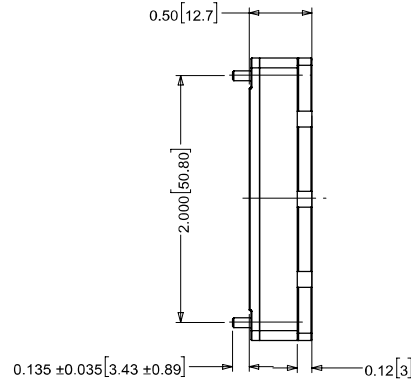

Top View

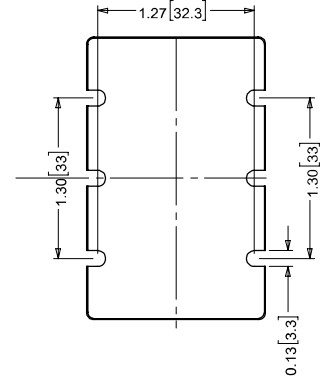

"V" OPTION PINS / PINOUT WITH SLOTTED / FIANGED BASPLATE

Pin Option#1 :
Pin 1-4,6,8: Dia 0.080

- NOTES:
UNLESS OTHERWISE SPECIFIED:
1:M3 SCREW USED TO BOLT UNIT'S BASEPLATE TO OTHER SURFACES(SUCH AS HEATSINK) MUST NOT EXCEED 0.100"(2.5mm) DEPTH BELOW THE SURFACE OF BASEPLATE
2:APPLIED TORQUE PER SCREW SHOULD NOT EXCEED 5.3In-lb(0.6Nm);
3:ALL DIMENSION ARE IN INCHES[MILIMETER];
4:ALL TOLERANCES: ×.××in ,±0.02in(×.×mm,±0.5mm)
×.×××in ,±0.01in(×.××mm,±0.25mm)

Material:
Pin 1-4,6,8: Dia 0.080 PINS: COPPER ALLOY
FINISH:(ALL PINS)
GOLD(5 u"MIN) OVER NICKEL (100u"MIN)

Dimensions are in inches (mm) shown for ref. only.

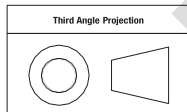

Tolerances (unless otherwise specified):
.XX ± 0.02 (0.5)
.XXX ± 0.010 (0.25)
Angles ± 2°

INPUT/OUTPUT CONNECTIONS

Pin	Function
1	Vin(+)
2	On/Off Control
3	Vin(-)
4	Vout(-)
6	Trim
8	Vout(+)

Top View

Pin Option#2

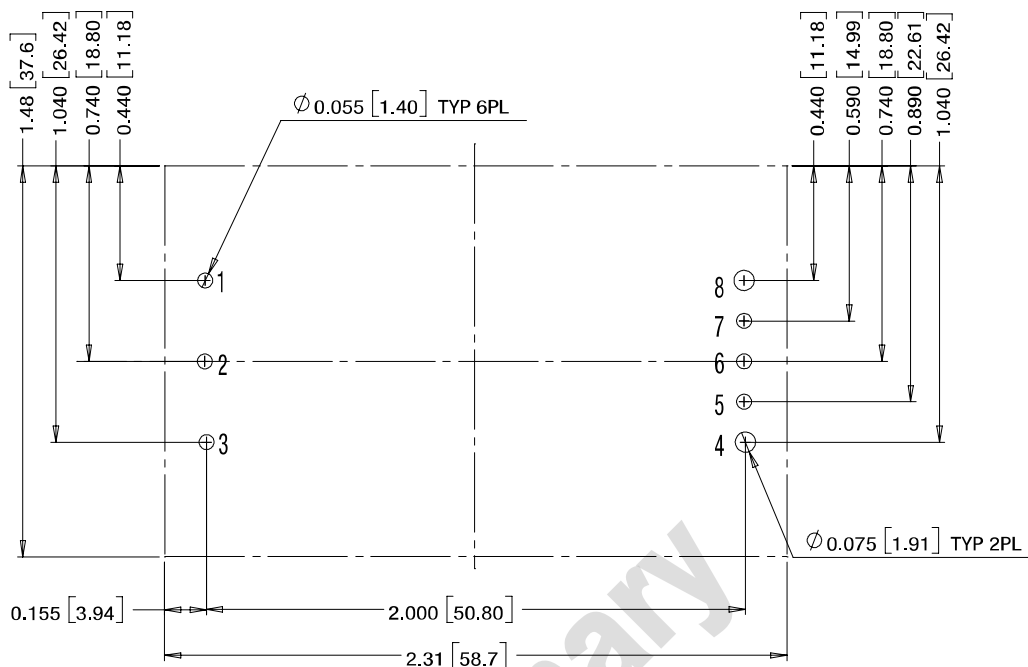

Recommended Footprint for Slotted / Flanged Baseplate and Standard Baseplate

Pin Option#1

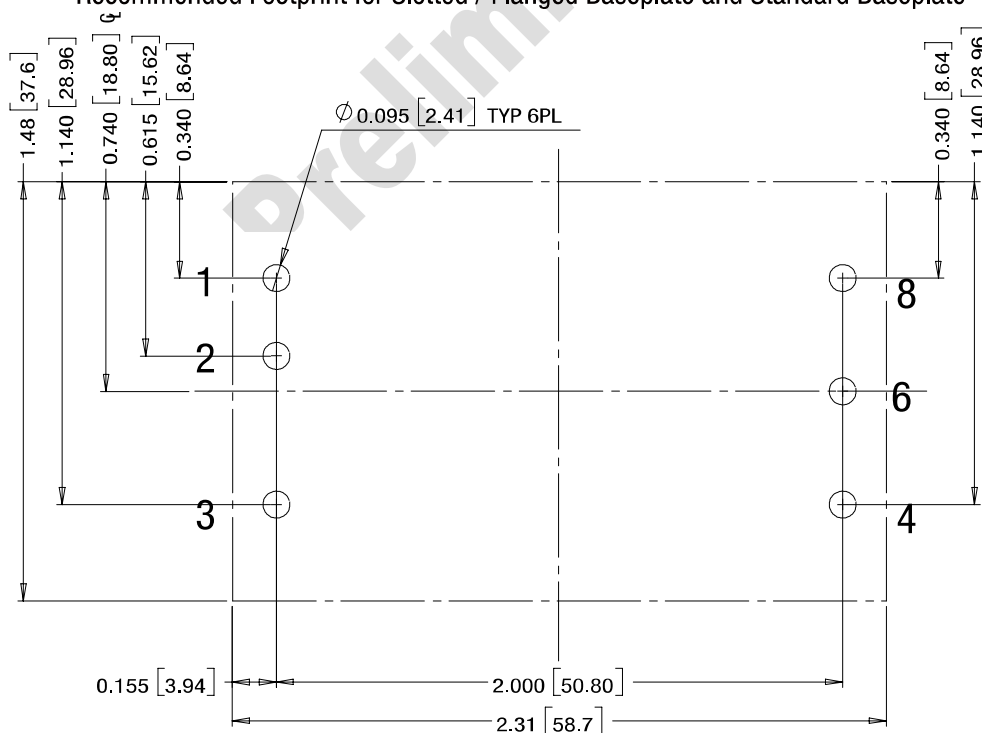

Recommended Footprint for "V" Option Pins / Pinout with Slotted / Flanged Baseplate

STANDARDS COMPLIANCE

Parameter	Notes
EN 60950-1/A12:2011	Reinforced insulation
UL 60950-1/R:2011-12	
CAN/CSA-C22.2 No. 60950-1/A1:2011	
IEC 61000-4-2	ESD test, 8 kV - NP, 15 kV air - NP (Normal Performance)

Note: An external input fuse must always be used to meet these safety requirements.

ENVIRONMENTAL QUALIFICATION TESTING

Parameter	# Units	Test Conditions
Vibration	15	EN 61373:1999 Category I, Class B, Body mounted
Mechanical Shock	15	EN 61373:1999 Category I, Class B, Body mounted
DMTBF(Life Test)	60	Vin nom , units at derating point,101days
Temperature Cycling Test(TCT)	15	-40 °C to 125 °C, unit temp. ramp 15 °C/min.,500cycles
Power and Temperature Cycling Test (PTCT)	5	Temperature operating = min to max, Vin = min to max, Load=50% of rated maximum,100cycles
Temperature ,Humidity and Bias(THB)	15	85 °C85RH,Vin=max, Load=min load,1072Hour(72hours with a pre-conditioning soak, unpowered)
Damp heat test, cyclic	15	EN60068-2-30: Temperatures: + 55 °C and + 25 °C; Number of cycles: 2 (respiration effect);Time: 2 x 24 hours; Relative Humidity: 95%
Dry heat test	5	EN60068-2-2, Vin=nom line, Full load, 85°C for 6 hours.
High Temperature Operating Bias(HTOB)	15	Vin=min to max ,95% rated load, units at derating point,500hours
Low Temperature operating	5	Vin=nom line, Full load,-40°C for 2 hours.
Highly Accelerated Life Test(HALT)	5	High temperature limits, low temperature limits, Vibration limits, Combined Environmental Tests.
EMI	3	Class A in CISPR 22 or IEC62236-3-2(GB/T 24338.4)
ESD	3	IEC 6100-4-2: +/-8kv contact discharge +/-15kv air discharge
Surge Protection	3	EN50121-3-2
Solderability	15Pins	MIL-STD-883, method 2003 (IPC/EIA/JEDEC J-SID-002B)

Technical Notes

On/Off Control

The input-side, remote On/Off Control function (pin 2) can be ordered to operate with either logic type:

Negative (“N” suffix): Negative-logic devices are off when pin 2 is left open (or pulled high, applying +3.5V to +13V), and on when pin 2 is pulled low (0 to 0.8V) with respect to –Input as shown in Figure 1.

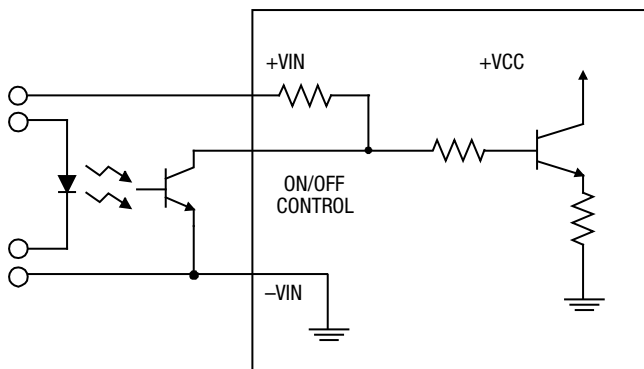

Figure 1. Driving the Negative Logic On/Off Control Pin

Dynamic control of the remote on/off function is best accomplished with a mechanical relay or an open-collector/open-drain drive circuit (optically isolated if appropriate). The drive circuit should be able to sink appropriate current (see Performance Specifications) when activated and withstand appropriate voltage when deactivated. Applying an external voltage to pin 2 when no input power is applied to the converter can cause permanent damage to the converter.

Input Fusing

Certain applications and/or safety agencies may require fuses at the inputs of power conversion components. Fuses should also be used when there is the possibility of sustained input voltage reversal which is not current-limited. For greatest safety, we recommend a fast blow fuse installed in the ungrounded input supply line.

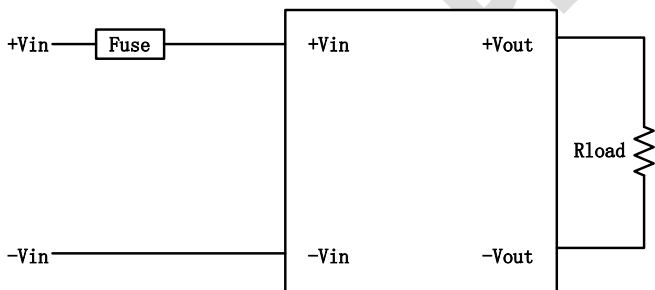

Figure 2. Input Fusing

Input Under-Voltage Shutdown and Start-Up Threshold

Under normal start-up conditions, converters will not begin to regulate properly until the rising input voltage exceeds and remains at the Start-Up Threshold Voltage (see Specifications). Once operating, converters will not turn off until the input voltage drops below the Under-Voltage Shutdown Limit. Subsequent restart will not occur until the input voltage rises again above the Start-Up Threshold. This built-in hysteresis prevents any unstable on/off operation at a single input voltage.

Start-Up Time

Assuming that the output current is set at the rated maximum, the Vin to

Vout Start-Up Time (see Specifications) is the time interval between the point when the rising input voltage crosses the Start-Up Threshold and the fully loaded output voltage enters and remains within its specified accuracy band. Actual measured times will vary with input source impedance, external input capacitance, input voltage slew rate and final value of the input voltage as it appears at the converter.

These converters include a soft start circuit to moderate the duty cycle of its PWM controller at power up, thereby limiting the input inrush current.

The On/Off Remote Control interval from On command to Vout (final ±5%) assumes that the converter already has its input voltage stabilized above the Start-Up Threshold before the On command. The interval is measured from the On command until the output enters and remains within its specified accuracy band. The specification assumes that the output is fully loaded at maximum rated current. Similar conditions apply to the On to Vout regulated specification such as external load capacitance and soft start circuitry.

Recommended Input Filtering

The user must assure that the input source has low AC impedance to provide dynamic stability and that the input supply has little or no inductive content, including long distributed wiring to a remote power supply. The converter will operate with no additional external capacitance if these conditions are met.

For best performance, we recommend installing a low-ESR capacitor immediately adjacent to the converter’s input terminals. The capacitor should be a ceramic type such as the Murata GRM32 series or a polymer type. Make sure that the input terminals do not go below the undervoltage shutdown voltage at all times. More input bulk capacitance may be added in parallel (either electrolytic or tantalum) if needed.

Recommended Output Filtering

The converter will achieve its rated output ripple and noise with no additional external capacitor. However, the user may install more external output capacitance to reduce the ripple even further or for improved dynamic response. Again, use low-ESR ceramic (Murata GRM32 series) or polymer capacitors. Mount these close to the converter. Measure the output ripple under your load conditions.

Use only as much capacitance as required to achieve your ripple and noise objectives. Excessive capacitance can make step load recovery sluggish or possibly introduce instability. Do not exceed the maximum rated output capacitance listed in the specifications.

Input Ripple Current and Output Noise

All models in this converter series are tested and specified for input reflected ripple current and output noise using designated external input/output components, circuits and layout as shown in the figures below. The Cbus and Lbus components simulate a typical DC voltage bus.

Output Over-Voltage Protection

The IRQ output voltage is monitored for an over-voltage condition using a comparator. The signal is optically coupled to the primary side and if the output voltage rises to a level which could be damaging to the load, the sensing circuitry will power down the PWM controller causing the output voltage to decrease. Following a time-out period the PWM will restart, causing the output voltage to ramp to its appropriate value. If the fault condition persists, and the output voltage again climbs to excessive levels, the over-voltage circuitry will initiate another shutdown cycle. This on/off cycling is referred to as “hiccup” mode.

Encapsulated 100-Watt Isolated DC-DC Converter

Murata Power Solutions makes Characterization measurements in a closed cycle wind tunnel with calibrated airflow. We use both thermocouples and an infrared camera system to observe thermal performance. As a practical matter, it is quite difficult to insert an anemometer to precisely measure airflow in most applications. Sometimes it is possible to estimate the effective airflow if you thoroughly understand the enclosure geometry, entry/exit orifice areas and the fan flow rate specifications.

CAUTION: If you exceed these Derating guidelines, the converter may have an unplanned Over Temperature shut down. Also, these graphs are all collected near Sea Level altitude. Be sure to reduce the derating for higher altitude.

Output Fusing

The converter is extensively protected against current, voltage and temperature extremes. However your output application circuit may need additional protection. In the extremely unlikely event of output circuit failure, excessive voltage could be applied to your circuit. Consider using an appropriate fuse in series with the output.

Output Current Limiting

Current limiting inception is defined as the point at which full power falls below the rated tolerance. See the Performance/Functional Specifications. Note particularly that the output current may briefly rise above its rated value in normal operation as long as the average output power is not exceeded. This enhances reliability and continued operation of your application. If the output current is too high, the converter will enter the short circuit condition.

Output Short Circuit Condition

When a converter is in current-limit mode, the output voltage will drop as the output current demand increases. If the output voltage drops too low (approximately 97% of nominal output voltage for most models), the PWM controller will shut down. Following a time-out period, the PWM will restart, causing the output voltage to begin rising to its appropriate value. If the short-circuit condition persists, another shutdown cycle will initiate. This rapid on/off cycling is called "hiccup mode." The hiccup cycling reduces the average output current, thereby preventing excessive internal temperatures and/or component damage.

The "hiccup" system differs from older latching short circuit systems because you do not have to power down the converter to make it restart. The system will automatically restore operation as soon as the short circuit condition is removed.

Output Capacitive Load

These converters do not require external capacitance added to achieve rated specifications. Users should only consider adding capacitance to reduce switching noise and/or to handle spike current load steps. Install only enough capacitance to achieve noise objectives. Excess external capacitance may cause degraded transient response and possible oscillation or instability.

NOTICE: Please use only this customer data sheet as product documentation when laying out your printed circuit boards and applying this product into your application. Do NOT use other materials as official documentation such as advertisements, product announcements, or website graphics.

We strive to have all technical data in this customer data sheet highly accurate and complete. This customer data sheet is revision-controlled and dated. The latest customer data sheet revision is normally on our website (www.murata-ps.com) for products which are fully released to Manufacturing. Please be especially careful using any data sheets labeled "Preliminary" since data may change without notice.

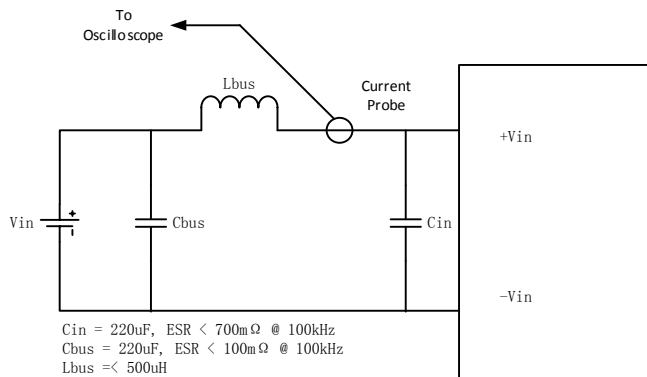

Figure 3. Measuring Input Ripple Current

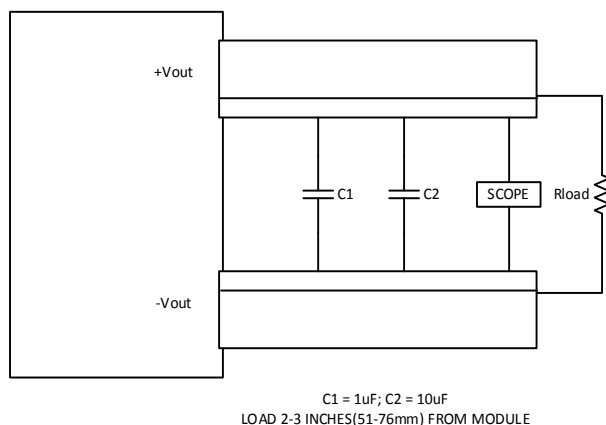

Figure 4 Measuring Output Ripple and Noise (PARD)

Minimum Output Loading Requirements

All models regulate within specification and are stable under no load to full load conditions. Operation under no load might however slightly increase output ripple and noise.

Thermal Shutdown

To prevent many over temperature problems and damage, these converters include thermal shutdown circuitry. If environmental conditions cause the temperature of the DC-DC's to rise above the Operating Temperature Range up to the shutdown temperature, an on-board electronic temperature sensor will power down the unit. When the temperature decreases below the turn-on threshold, the converter will automatically restart. There is a small amount of hysteresis to prevent rapid on/off cycling.

CAUTION: If you operate too close to the thermal limits, the converter may shut down suddenly without warning. Be sure to thoroughly test your application to avoid unplanned thermal shutdown.

Temperature Derating Curves

The graphs in this data sheet illustrate typical operation under a variety of conditions. The Derating curves show the maximum continuous ambient air temperature and decreasing maximum output current which is acceptable under increasing forced airflow measured in Linear Feet per Minute ("LFM"). Note that these are AVERAGE measurements. The converter will accept brief increases in current or reduced airflow as long as the average is not exceeded.

Note that the temperatures are of the ambient airflow, not the converter itself which is obviously running at higher temperature than the outside air.

Encapsulated 100-Watt Isolated DC-DC Converter

Trimming the Output Voltage

The Trim input to the converter allows the user to adjust the output voltage over the rated trim range (please refer to the Specifications). In the trim equations and circuit diagrams that follow, trim adjustments use either a trimpot or a single fixed resistor connected between the Trim input and either the +Sense or –Sense terminals. Trimming resistors should have a low temperature coefficient (± 100 ppm/deg.C or less) and be mounted close to the converter. Keep leads short. If the trim function is not used, leave the trim unconnected. With no trim, the converter will exhibit its specified output voltage accuracy.

There are two CAUTIONs to observe for the Trim input:

CAUTION: To avoid unplanned power down cycles, do not exceed EITHER the maximum output voltage OR the maximum output power when setting the trim. Be particularly careful with a trimpot. If the output voltage is excessive, the OVP circuit may inadvertently shut down the converter. If the maximum power is exceeded, the converter may enter current limiting. If the power is exceeded for an extended period, the converter may overheat and encounter overtemperature shut down.

CAUTION: Be careful of external electrical noise. The Trim input is a sensitive input to the converter’s feedback control loop. Excessive electrical noise may cause instability or oscillation. Keep external connections short to the Trim input. Use shielding if needed.

Trim Equations

Trim Down

Connect trim resistor between trim pin and –Sense

$$R_{TrimDn} (k \Omega) = \frac{5.11}{D} - 10.22$$

Trim Up

Connect trim resistor between trim pin and +Sense

$$R_{TrimUp} (k \Omega) = \frac{5.11 * V_{nom} * (1+D)}{1.225 * D} - \frac{5.11}{D} - 10.22$$

Where,

$$D = I (V_{nom} - V_{out}) / V_{nom}$$

V_{nom} is the nominal, untrimmed output voltage.

V_{out} is the desired new output voltage.

Do not exceed the specified trim range or maximum power ratings when adjusting trim. Use 1% precision resistors mounted close to the converter on short leads.

If sense is not installed, connect the trim resistor to the respective V_{out} pin.

Trim Circuits

Remote Sense Input

Use the Sense inputs with caution. Sense is normally connected **at the load**. Sense inputs compensate for output voltage inaccuracy delivered at the load. This is done by correcting IR voltage drops along the output wiring and the current carrying capacity of PC board etch. This output drop (the difference between Sense and V_{out} when measured at the converter) should not exceed 0.5V. Consider using heavier wire if this drop is excessive. Sense inputs also improve the stability of the converter and load system by optimizing the control loop phase margin.

NOTE: The Sense input and power V_{out} lines are internally connected through low value resistors to their respective polarities so that the converter can operate without external connection to the Sense. Nevertheless, if the Sense function is not used for remote regulation, the user should connect +Sense to + V_{out} and –Sense to – V_{out} at the converter pins.

The remote Sense lines carry very little current. They are also capacitively coupled to the output lines and therefore are in the feedback control loop to regulate and stabilize the output. As such, they are not low impedance inputs and must be treated with care in PC board layouts. Sense lines on the PCB should run adjacent to DC signals, preferably Ground. In cables and discrete wiring, use twisted pair, shielded tubing or similar techniques.

Any long, distributed wiring and/or significant inductance introduced into the Sense control loop can adversely affect overall system stability. If in doubt, test your applications by observing the converter’s output transient response during step loads. There should not be any appreciable ringing or oscillation. You may also adjust the output trim slightly to compensate for voltage loss in any external filter elements. Do not exceed maximum power ratings.

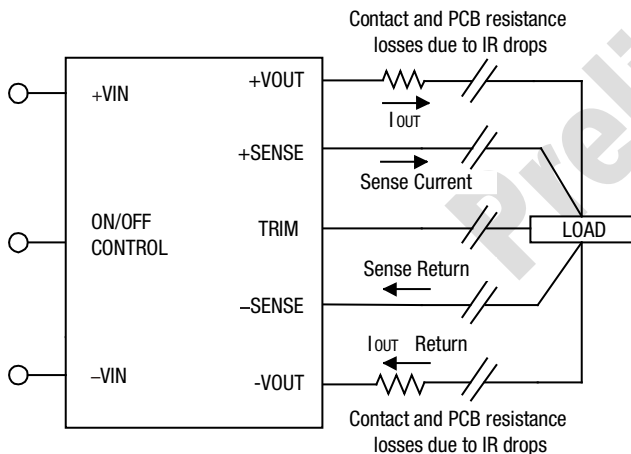

Figure 5 Remote Sense Circuit Configuration

Please observe Sense inputs tolerance to avoid improper operation:

$$[V_{out}(+) - V_{out}(-)] - [Sense(+) - Sense(-)] \leq 10\% \text{ of } V_{out}$$

Output overvoltage protection is monitored at the output voltage pin, not the Sense pin. Therefore excessive voltage differences between V_{out} and Sense together with trim adjustment of the output can cause the overvoltage protection circuit to activate and shut down the output.

Power derating of the converter is based on the combination of maximum output current and the highest output voltage. Therefore the designer must insure:

$$(V_{out} \text{ at pins}) \times (I_{out}) \leq (\text{Max. rated output power})$$

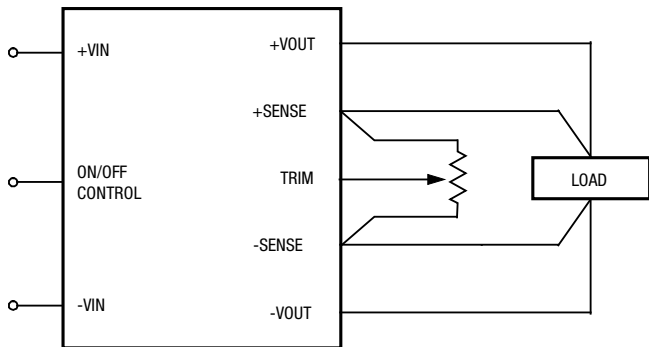

Figure 6 Trim Connections Using A Trimpot

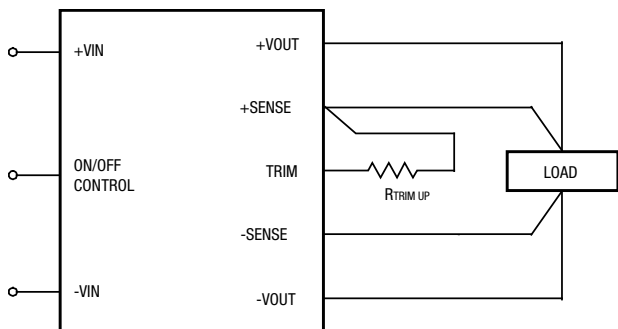

Figure 7 Trim Connections to Increase Output Voltages

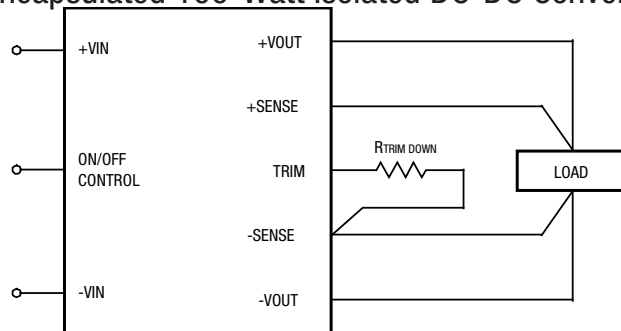
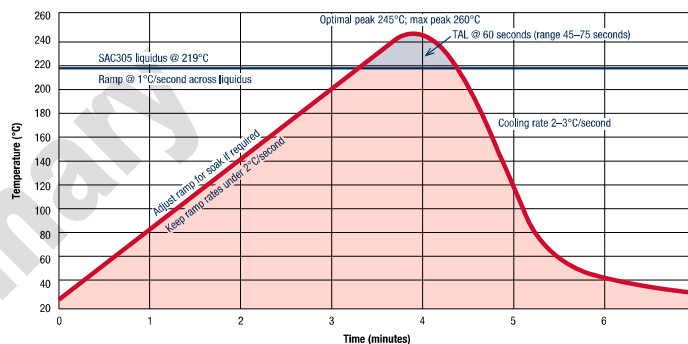
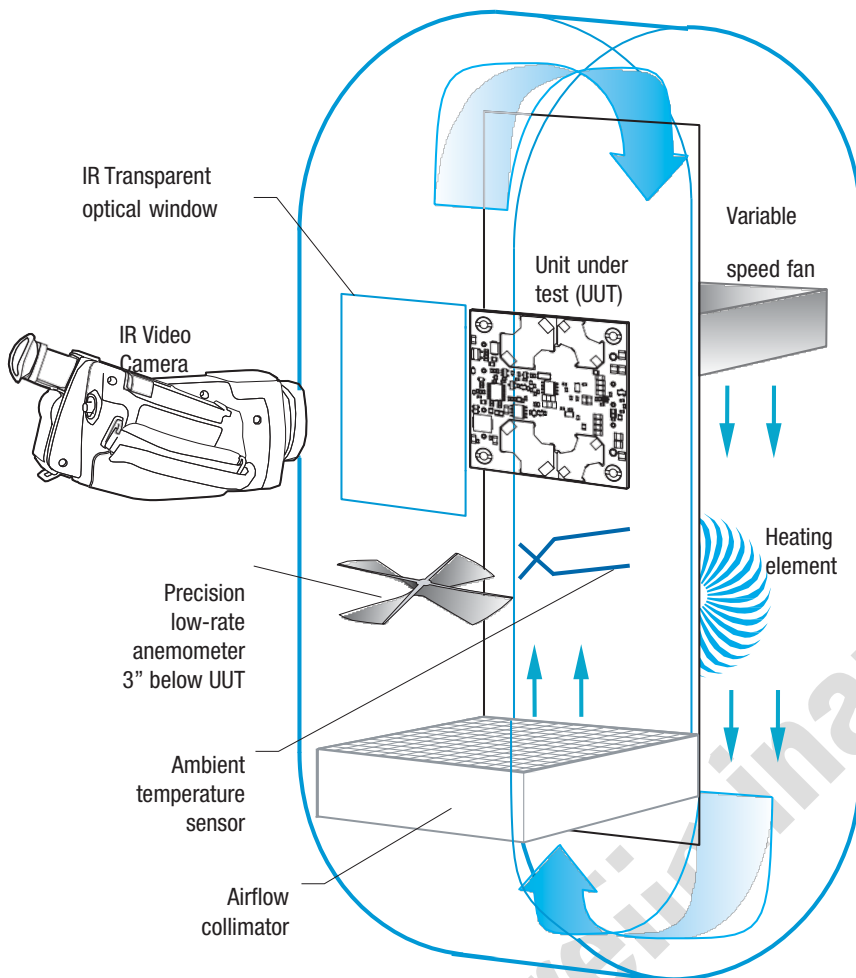

Figure 8 Trim Connections to Decrease Output Voltage

SMT Reflow Soldering Guidelines

The surface-mount reflow solder profile shown below is suitable for SAC305 type lead-free solders. This graph should be used only as a **guideline**. Many other factors influence the success of SMT reflow soldering. Since your production environment may differ, please thoroughly review these guidelines with your process engineers.





Vertical Wind Tunnel

Murata Power Solutions employs a computer controlled custom-designed closed loop vertical wind tunnel, infrared video camera system, and test instrumentation for accurate airflow and heat dissipation analysis of power products. The system includes a precision low flow-rate anemometer, variable speed fan, power supply input and load controls,

temperature gauges, and adjustable heating element.

The IR camera monitors the thermal performance of the Unit Under Test (UUT) under static steady-state conditions. A special optical port is used which is transparent to infrared wavelengths.

Both through-hole and surface mount converters are soldered down to a 10"x10" host carrier board for realistic heat absorption and spreading. Both longitudinal and transverse airflow studies are possible by rotation of this carrier board since there are often significant differences in the heat dissipation in the two airflow directions. The combination of adjustable airflow, adjustable ambient heat, and adjustable Input/Output currents and voltages mean that a very wide range of measurement conditions can be studied.

The collimator reduces the amount of turbulence adjacent to the UUT by minimizing airflow turbulence. Such turbulence influences the effective heat transfer characteristics and gives false readings. Excess turbulence removes more heat from some surfaces and less heat from others, possibly causing uneven overheating.

Both sides of the UUT are studied since there are different thermal gradients on each side. The adjustable heating element and fan, built-in temperature gauges, and no-contact IR camera mean that power supplies are tested in real-world conditions.

Murata Power Solutions, Inc.
 11 Cabot Boulevard, Mansfield, MA 02048-1151 U.S.A.
 ISO 9001 and 14001 REGISTERED



This product is subject to the following operating requirements and the Life and Safety Critical Application Sales Policy:

Refer to: <http://www.murata-ps.com/requirements/>

Murata Power Solutions, Inc. makes no representation that the use of its products in the circuits described herein, or the use of other technical information contained herein, will not infringe upon existing or future patent rights. The descriptions contained herein do not imply the granting of licenses to make, use, or sell equipment constructed in accordance therewith. Specifications are subject to change without notice. © 2016 Murata Power Solutions, Inc.



Компания «ЭлектроПласт» предлагает заключение долгосрочных отношений при поставках импортных электронных компонентов на взаимовыгодных условиях!

Наши преимущества:

- Оперативные поставки широкого спектра электронных компонентов отечественного и импортного производства напрямую от производителей и с крупнейших мировых складов;
- Поставка более 17-ти миллионов наименований электронных компонентов;
- Поставка сложных, дефицитных, либо снятых с производства позиций;
- Оперативные сроки поставки под заказ (от 5 рабочих дней);
- Экспресс доставка в любую точку России;
- Техническая поддержка проекта, помощь в подборе аналогов, поставка прототипов;
- Система менеджмента качества сертифицирована по Международному стандарту ISO 9001;
- Лицензия ФСБ на осуществление работ с использованием сведений, составляющих государственную тайну;
- Поставка специализированных компонентов (Xilinx, Altera, Analog Devices, Intersil, Interpoint, Microsemi, Aeroflex, Peregrine, Syfer, Eurofarad, Texas Instrument, Miteq, Cobham, E2V, MA-COM, Hittite, Mini-Circuits, General Dynamics и др.);

Помимо этого, одним из направлений компании «ЭлектроПласт» является направление «Источники питания». Мы предлагаем Вам помощь Конструкторского отдела:

- Подбор оптимального решения, техническое обоснование при выборе компонента;
- Подбор аналогов;
- Консультации по применению компонента;
- Поставка образцов и прототипов;
- Техническая поддержка проекта;
- Защита от снятия компонента с производства.



Как с нами связаться

Телефон: 8 (812) 309 58 32 (многоканальный)

Факс: 8 (812) 320-02-42

Электронная почта: org@eplast1.ru

Адрес: 198099, г. Санкт-Петербург, ул. Калинина, дом 2, корпус 4, литера А.