

Description

The Advanced Ultra Low Power (AUP) CMOS logic family is designed for low power and extended battery life in portable applications.

The 74AUP2G3404 has one buffer and one inverter. Both gates have push-pull outputs designed for operation over a power supply range of 0.8V to 3.6V. The device is fully specified for partial power down applications using I_{OFF}. The I_{OFF} circuitry disables the output preventing damaging current backflow when the device is powered down.

Features

- Advanced Ultra Low Power (AUP) CMOS
- Supply Voltage Range from 0.8V to 3.6V
- ± 4mA Output Drive at 3.0V
- Low Static power consumption
 - I_{CC} < 0.9µA
- Low Dynamic Power Consumption
 - C_{PD} = 6pF Typical at 3.6V
- Schmitt Trigger Action at All Inputs Make the Circuit Tolerant for Slower Input Rise and Fall Time. The hysteresis is typically 250mV at V_{CC} = 3.0V
- I_{OFF} Supports Partial-Power-Down Mode Operation
 - ESD Protection per JESD 22
 - Exceeds 200-V Machine Model (A115)
 - Exceeds 2000-V Human Body Model (A114-)
 - Exceeds 1000-V Charged Device Model (C101)
- Latch-Up Exceeds 100mA per JESD 78, Class I
- Leadless packages per JESD30E
 - DFN1410 denoted as X2-DFN1410-6
 - DFN1010 denoted as X2-DFN1010-6
 - DFN0910 denoted as X2-DFN0910-6
- **Totally Lead-Free & Fully RoHS Compliant (Notes 1 & 2)**
- **Halogen and Antimony Free. "Green" Device (Note 3)**

Notes:

1. No purposely added lead. Fully EU Directive 2002/95/EC (RoHS) & 2011/65/EU (RoHS 2) compliant.
2. See http://www.diodes.com/quality/lead_free.html for more information about Diodes Incorporated's definitions of Halogen- and Antimony-free, "Green" and Lead-free.
3. Halogen- and Antimony-free "Green" products are defined as those which contain <900ppm bromine, <900ppm chlorine (<1500ppm total Br + Cl) and <1000ppm antimony compounds.

Pin Assignments

(Top View)

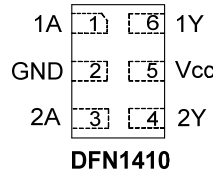

(Top View)

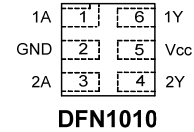

(Top View)

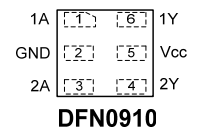

Applications

- Suited for battery and low power needs
- Wide array of products such as:
 - PCs, networking, Notebooks, Netbooks, PDAs
 - Tablet Computers, E-Readers
 - Computer Peripherals, Hard Drives, CD/DVD ROM
 - TV, DVD, DVR, Set Top Box
 - Cell Phones, Personal Navigation / GPS
 - MP3 players, Cameras, Video Recorders

[Click for Ordering Information](#)

Pin Descriptions

Pin Name	Pin No.	Function
1A	1	Data Input
GND	2	Ground
2A	3	Data Input
2Y	4	Data Output
V _{CC}	5	Supply Voltage
1Y	6	Data Output

Logic Diagram

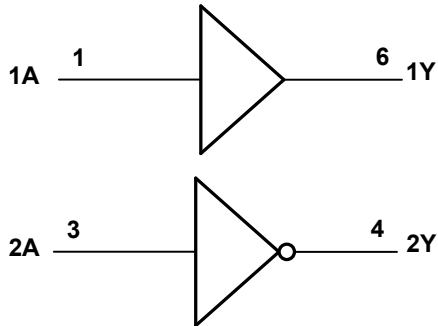

Function Tables

Input	Output
1A	1Y
H	H
L	L

Input	Output
2A	2Y
H	L
L	H

Absolute Maximum Ratings (Note 4) (@ $T_A = +25^\circ\text{C}$, unless otherwise specified.)

Symbol	Description	Rating	Unit
ESD HBM	Human Body Model ESD Protection	2	KV
ESD CDM	Charged Device Model ESD Protection	1	KV
ESD MM	Machine Model ESD Protection	200	V
V_{CC}	Supply Voltage Range	-0.5 to 4.6	V
V_I	Input Voltage Range	-0.5 to 4.6	V
V_O	Voltage applied to output in high or low state	-0.5 to $V_{CC} + 0.5$	V
I_{IK}	Input Clamp Current ($V_I < 0$)	50	mA
I_{OK}	Output Clamp Current ($V_O < 0$)	-50	mA
I_O	Continuous Output Current ($V_O = 0$ to V_{CC})	± 20	mA
I_{CC}	Continuous Current Through V_{CC}	50	mA
I_{GND}	Continuous Current Through GND	-50	mA
T_J	Operating Junction Temperature	-40 to +150	$^\circ\text{C}$
T_{STG}	Storage Temperature	-65 to +150	$^\circ\text{C}$

Note: 4. Stresses beyond the absolute maximum may result in immediate failure or reduced reliability. These are stress values and device operation should be within recommend values.

Recommended Operating Conditions (Note 5) (@ $T_A = +25^\circ\text{C}$, unless otherwise specified.)

Symbol	Parameter	Min	Max	Unit	
V_{CC}	Operating Voltage	—	0.8	3.6	V
V_I	Input Voltage	0	3.6	V	
V_O	Output Voltage	0	V_{CC}	V	
I_{OH}	High-Level Output Current	$V_{CC} = 0.8\text{V}$	—	-20	μA
		$V_{CC} = 1.1\text{V}$	—	-1.1	mA
		$V_{CC} = 1.4\text{V}$	—	-1.7	
		$V_{CC} = 1.65\text{V}$	—	-1.9	
		$V_{CC} = 2.3\text{V}$	—	-3.1	
		$V_{CC} = 3.0\text{V}$	—	-4	
I_{OL}	Low-Level Output Current	$V_{CC} = 0.8\text{V}$	—	20	μA
		$V_{CC} = 1.1\text{V}$	—	1.1	mA
		$V_{CC} = 1.4\text{V}$	—	1.7	
		$V_{CC} = 1.65\text{V}$	—	1.9	
		$V_{CC} = 2.3\text{V}$	—	3.1	
		$V_{CC} = 3.0\text{V}$	—	4	
$\Delta t/\Delta V$	Input transition rise or fall rate	$V_{CC} = 0.8\text{V}$ to 3.6V	—	200	ns/V
T_A	Operating free-air temperature	—	-40	+125	$^\circ\text{C}$

Note: 5. Unused inputs should be held at V_{CC} or Ground.

Electrical Characteristics (@T_A = +25°C, unless otherwise specified.)

Symbol	Parameter	Test Conditions	V _{CC}	T _A = +25°C		T _A = -40 to +85°C		Unit
				Min	Max	Min	Max	
V _{IH}	High-Level Input Voltage	—	0.8V to 1.65V	0.80 X V _{CC}	—	0.80 X V _{CC}	—	V
		—	1.65V to 1.95V	0.65 X V _{CC}	—	0.65 X V _{CC}	—	
		—	2.3V to 2.7V	1.6	—	1.6	—	
		—	3.0V to 3.6V	2.0	—	2.0	—	
V _{IL}	Low-Level Input Voltage	—	0.8V to 1.65V	—	0.30 X V _{CC}	—	0.30 X V _{CC}	V
		—	1.65V to 1.95V	—	0.35 X V _{CC}	—	0.35 X V _{CC}	
		—	2.3V to 2.7V	—	0.7	—	0.7	
		—	3.0V to 3.6V	—	0.9	—	0.9	
V _{OH}	High-Level Output Voltage	I _{OH} = -20μA	0.8V to 3.6V	V _{CC} - 0.1	—	V _{CC} - 0.1	—	V
		I _{OH} = -1.1mA	1.1V	0.75 X V _{CC}	—	0.7 X V _{CC}	—	
		I _{OH} = -1.7mA	1.4V	1.11	—	1.03	—	
		I _{OH} = -1.9mA	1.65V	1.32	—	1.3	—	
		I _{OH} = -2.3mA	2.3V	2.05	—	1.97	—	
		I _{OH} = -3.1mA		1.9	—	1.85	—	
		I _{OH} = -2.7mA	3V	2.72	—	2.67	—	
		I _{OH} = -4mA		2.6	—	2.55	—	
V _{OL}	Low-Level Input Voltage	I _{OL} = 20μA	0.8V to 3.6V	—	0.1	—	0.1	V
		I _{OL} = 1.1mA	1.1V	—	0.3 X V _{CC}	—	0.3 X V _{CC}	
		I _{OL} = 1.7mA	1.4V	—	0.31	—	0.37	
		I _{OL} = 1.9mA	1.65V	—	0.31	—	0.35	
		I _{OL} = 2.3mA	2.3V	—	0.31	—	0.33	
		I _{OL} = 3.1mA		—	0.44	—	0.45	
		I _{OL} = 2.7mA	3V	—	0.31	—	0.33	
		I _{OL} = 4mA		—	0.44	—	0.45	
I _I	Input Current	A or B Input	0V to 3.6V	—	± 0.1	—	± 0.5	μA
I _{OFF}	Power Down	V _I or V _O = 0V to 3.6V	0V	—	± 0.2	—	± 0.6	μA
ΔI _{OFF}	Delta Power	V _I or V _O = 0V to 3.6V	0V to 0.2V	—	± 0.2	—	± 0.6	μA
I _{CC}	Supply Current	V _I = GND or V _{CC} , I _O = 0	0.8V to 3.6V	—	0.5	—	0.9	μA
ΔI _{CC}	Additional Supply	One input at V _{CC} - 0.6V Other	3.3V	—	40	—	50	μA

Electrical Characteristics (cont.) (@ $T_A = +25^\circ\text{C}$, unless otherwise specified.)

Symbol	Parameter	Test Conditions	V _{CC}	T _A = -40 to 125°C		Unit
				Min	Max	
V _{IH}	High-Level Input Voltage	—	0.8V to 1.65V	0.80 X V _{CC}	—	V
		—	1.65V to 1.95V	0.70 X V _{CC}	—	
		—	2.3V to 2.7V	1.6	—	
		—	3.0V to 3.6V	2.0	—	
V _{IL}	Low-Level Input Voltage	—	0.8V to 1.65V	—	0.25 X V _{CC}	V
		—	1.65V to 1.95V	—	0.30 X V _{CC}	
		—	2.3V to 2.7V	—	0.7	
		—	3.0V to 3.6V	—	0.9	
V _{OH}	High-Level Output Voltage	I _{OH} = -20μA	0.8V to 3.6V	V _{CC} - 0.11	—	V
		I _{OH} = -1.1mA	1.1V	0.6 X V _{CC}	—	
		I _{OH} = -1.7mA	1.4V	0.93	—	
		I _{OH} = -1.9mA	1.65V	1.17	—	
		I _{OH} = -2.3mA	2.3V	1.77	—	
		I _{OH} = -3.1mA		1.67	—	
		I _{OH} = -2.7mA	3V	2.40	—	
I _{OH} = -4mA	2.30	—				
V _{OL}	Low-Level Input Voltage	I _{OL} = 20μA	0.8V to 3.6V	—	0.11	V
		I _{OL} = 1.1mA	1.1V	—	0.33 X V _{CC}	
		I _{OL} = 1.7mA	1.4V	—	0.41	
		I _{OL} = 1.9mA	1.65V	—	0.39	
		I _{OL} = 2.3mA	2.3V	—	0.36	
		I _{OL} = 3.1mA		—	0.50	
		I _{OL} = 2.7mA	3V	—	0.36	
		I _{OL} = 4mA		—	0.50	
I _I	Input Current	A or B Input, V _I = GND to 3.6V	0V to 3.6V	—	± 0.75	μA
I _{OFF}	Power Down Leakage Current	V _I or V _O = 0V to 3.6V	0V	—	± 1.0	μA
ΔI _{OFF}	Delta Power Down Leakage Current	V _I or V _O = 0V to 3.6V	0V to 0.2V	—	± 2.5	μA
I _{CC}	Supply Current	V _I = GND or V _{CC} , I _O = 0	0.8V to 3.6V	—	1.4	μA
ΔI _{CC}	Additional Supply Current	Input at V _{CC} - 0.6V Other input at V _{CC} or GND	3.3V	—	75	μA

Operating and Package Characteristics
 $T_A = +25^\circ\text{C}$

Parameter		Test Conditions	V _{CC}	Typ	Unit
C _{pd}	Power dissipation capacitance	f = 1MHz No Load	0.8V	5.1	pF
			1.2V ± 0.1V	5.2	
			1.5V ± 0.1V	5.2	
			1.8V ± 0.15V	5.5	
			2.5V ± 0.2V	5.7	
			3.3V ± 0.3V	6.0	
C _I	Input Capacitance	V _I = V _{CC} or GND	0V or 3.3V	2.0	pF
C _O	Output Capacitance	V _O = V _{CC} or GND	0V	3.5	pF

Switching Characteristics
 $C_L = 5\text{pF}$ see Figure 1

Parameter	From Input	TO OUTPUT	V_{CC}	$T_A = +25^\circ\text{C}$			$T_A = -40 \text{ to } +85^\circ\text{C}$		$T_A = -40 \text{ to } +125^\circ\text{C}$		Unit
				Min	Typ	Max	Min	Max	Min	Max	
t_{pd}	A	Y	0.8V		16.0						ns
			$1.2\text{V} \pm 0.1\text{V}$	2.4	5.0	10.3	2.0	11.4	2.0	12.6	
			$1.5\text{V} \pm 0.1\text{V}$	1.8	3.6	6.4	1.6	7.4	1.6	8.2	
			$1.8\text{V} \pm 0.15\text{V}$	1.5	2.9	5.0	1.4	5.9	1.4	6.5	
			$2.5\text{V} \pm 0.2\text{V}$	1.2	2.4	3.9	1.1	4.5	1.1	5.0	
			$3.3\text{V} \pm 0.3\text{V}$	1.1	2.1	3.2	1.0	3.9	1.0	4.3	

 $C_L = 10\text{pF}$ see Figure 1

Parameter	From Input	TO OUTPUT	V_{CC}	$T_A = +25^\circ\text{C}$			$T_A = -40 \text{ to } +85^\circ\text{C}$		$T_A = -40 \text{ to } +125^\circ\text{C}$		Unit
				Min	Typ	Max	Min	Max	Min	Max	
t_{pd}	A	Y	0.8V		19.8						ns
			$1.2\text{V} \pm 0.1\text{V}$	2.8	5.9	12.2	2.3	13.7	2.3	15.1	
			$1.5\text{V} \pm 0.1\text{V}$	2.3	4.2	7.5	1.9	8.7	1.9	9.6	
			$1.8\text{V} \pm 0.15\text{V}$	2.0	3.5	5.9	1.7	7.0	1.7	7.7	
			$2.5\text{V} \pm 0.2\text{V}$	1.7	2.9	4.6	1.5	5.4	1.5	6.0	
			$3.3\text{V} \pm 0.3\text{V}$	1.6	2.7	3.8	1.4	4.5	1.4	5.1	

 $C_L = 15\text{pF}$ see Figure 1

Parameter	From Input	TO OUTPUT	V_{CC}	$T_A = +25^\circ\text{C}$			$T_A = -40 \text{ to } +85^\circ\text{C}$		$T_A = -40 \text{ to } +125^\circ\text{C}$		Unit
				Min	Typ	Max	Min	Max	Min	Max	
t_{pd}	A	Y	0.8V		23.3						ns
			$1.2\text{V} \pm 0.1\text{V}$	3.2	6.7	13.0	2.6	15.8	2.6	17.4	
			$1.5\text{V} \pm 0.1\text{V}$	2.6	4.7	8.6	2.2	10.0	2.2	11.0	
			$1.8\text{V} \pm 0.15\text{V}$	2.3	4.0	6.7	2.0	8.0	2.0	8.8	
			$2.5\text{V} \pm 0.2\text{V}$	2.1	3.3	5.1	1.8	6.1	1.8	6.8	
			$3.3\text{V} \pm 0.3\text{V}$	2.0	3.1	4.2	1.6	5.0	1.6	5.5	

 $C_L = 30\text{pF}$ see Figure 1

Parameter	From Input	TO OUTPUT	V_{CC}	$T_A = +25^\circ\text{C}$			$T_A = -40 \text{ to } +85^\circ\text{C}$		$T_A = -40 \text{ to } +125^\circ\text{C}$		Unit
				Min	Typ	Max	Min	Max	Min	Max	
t_{pd}	A	Y	0.8V		33.6						ns
			$1.2\text{V} \pm 0.1\text{V}$	4.4	8.9	16.3	3.6	19.0	3.6	20.9	
			$1.5\text{V} \pm 0.1\text{V}$	3.6	6.3	10.8	3.2	12.9	3.2	14.2	
			$1.8\text{V} \pm 0.15\text{V}$	3.2	5.3	9.0	2.9	10.5	2.9	11.6	
			$2.5\text{V} \pm 0.2\text{V}$	2.4	4.5	6.5	2.6	7.6	2.6	8.5	
			$3.3\text{V} \pm 0.3\text{V}$	2.2	4.2	5.6	2.2	6.2	2.2	7.2	

Parameter Measurement Information

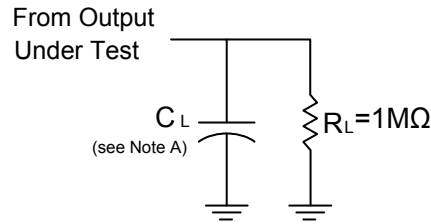

V_{CC}	Inputs		V_M	C_L
	V_I	t_r/t_f		
0.8 V	V_{CC}	$\leq 3ns$	$V_{CC}/2$	5, 10, 15, 30pF
1.2V±0.1V	V_{CC}	$\leq 3ns$	$V_{CC}/2$	5, 10, 15, 30pF
1.5V±0.1V	V_{CC}	$\leq 3ns$	$V_{CC}/2$	5, 10, 15, 30pF
1.8V±0.15V	V_{CC}	$\leq 3ns$	$V_{CC}/2$	5, 10, 15, 30pF
2.5V±0.2V	V_{CC}	$\leq 3ns$	$V_{CC}/2$	5, 10, 15, 30pF
3.3V±0.3V	V_{CC}	$\leq 3ns$	$V_{CC}/2$	5, 10, 15, 30pF

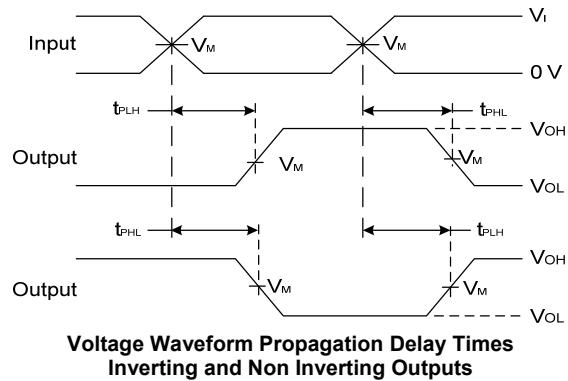
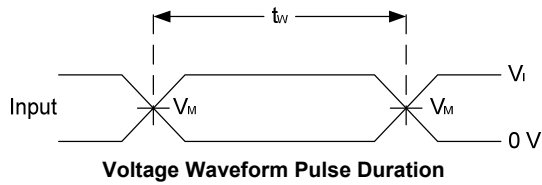
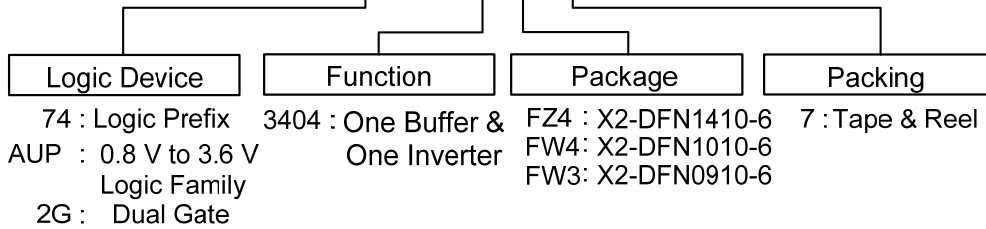

Figure 1 Load Circuit and Voltage Waveforms

- Notes:
- A. Includes test lead and test apparatus capacitance.
 - B. All pulses are supplied at pulse repetition rate ≤ 10 MHz.
 - C. Inputs are measured separately one transition per measurement.
 - D. t_{PLH} and t_{PHL} are the same as t_{PD} .

Ordering Information

74AUP2G 3404 XX - 7



Device	Package Code	Packaging (Note 7)	7" Tape and Reel	
			Quantity	Part Number Suffix
74AUP2G3404FZ4-7	FZ4	X2-DFN1410-6	5000/Tape & Reel	-7
74AUP2G3404FW4-7	FW4	X2-DFN1010-6	5000/Tape & Reel	-7
74AUP2G3404FW3-7	FW3	X2-DFN0910-6	5000/Tape & Reel	-7

Note: 7. The taping orientation is located on our website at <http://www.diodes.com/datasheets/ap02007.pdf>
 8. For packaging details, go to our website at <http://www.diodes.com/products/packages.html>

Marking Information

(1) X2-DFN1410-6, X2-DFN1010-6, X2-DFN0910-6

(Top View)

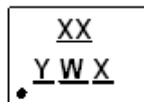

XX : Identification Code
 Y : Year : 0~9
 W : Week : A~Z : 1~26 week;
 a~z : 27~52 week; z represents
 52 and 53 week
 X : A~Z : Internal code

Part Number	Package	Identification Code
74AUP2G3404FZ4	X2-DFN1410-6	RU
74AUP2G3404FW4	X2-DFN1010-6	SU
74AUP2G3404FW3	X2-DFN0910-6	MU

Package Outline Dimensions (All dimensions in mm.)

Please see AP02002 at <http://www.diodes.com/datasheets/ap02002.pdf> for latest version.

(1) Package Type X2-DFN1410-6

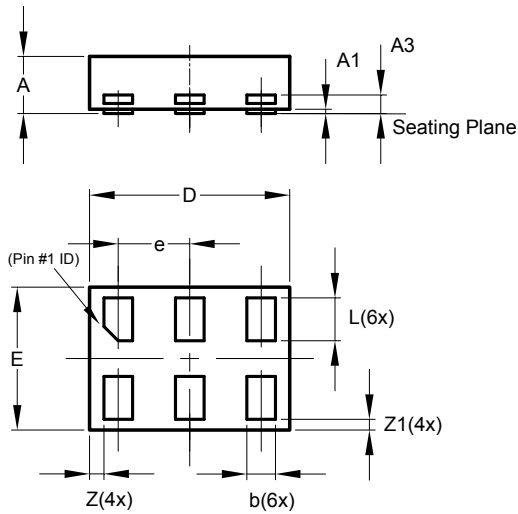

X2-DFN1410-6			
Dim	Min	Max	Typ
A	—	0.40	0.39
A1	0.00	0.05	0.02
A3	—	—	0.13
b	0.15	0.25	0.20
D	1.35	1.45	1.40
E	0.95	1.05	1.00
e	—	—	0.50
L	0.25	0.35	0.30
Z	—	—	0.10
Z1	0.045	0.105	0.075
All Dimensions in mm			

(2) Package Type: X2-DFN1010-6

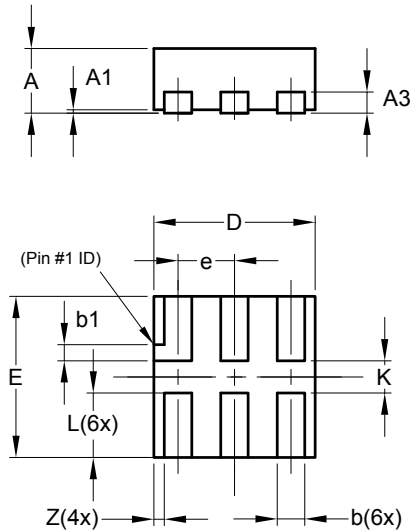

X2-DFN1010-6			
Dim	Min	Max	Typ
A	—	0.40	0.39
A1	0.00	0.05	0.02
A3	—	—	0.13
b	0.14	0.20	0.17
b1	0.05	0.15	0.10
D	0.95	1.05	1.00
E	0.95	1.05	1.00
e	—	—	0.35
L	0.35	0.45	0.40
K	0.15	—	—
Z	—	—	0.065
All Dimensions in mm			

Package Outline Dimensions (cont.) (All dimensions in mm.)

Please see AP02002 at <http://www.diodes.com/datasheets/ap02002.pdf> for latest version.

(3) Package Type: X2-DFN0910-6

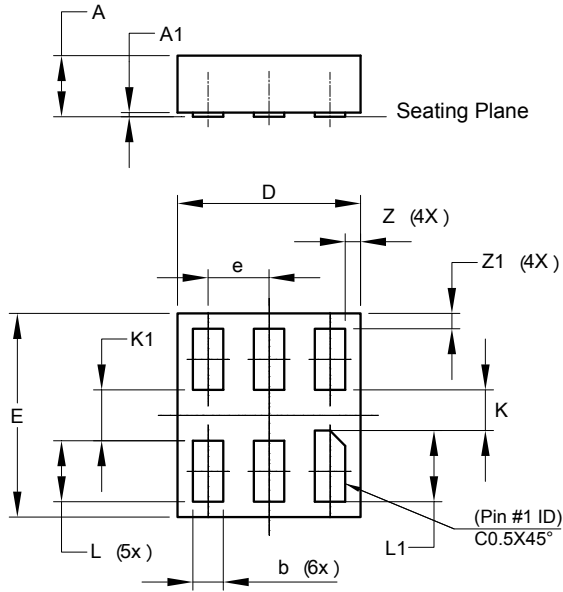

X2-DFN0910-6			
Dim	Min	Max	Typ
A	-	0.35	0.30
A1	0	0.03	0.02
b	0.10	0.20	0.15
D	0.85	0.95	0.90
E	0.95	1.05	1.00
e	-	-	0.30
K	0.20	-	-
K1	0.25	-	-
L	0.25	0.35	0.30
L1	0.30	0.40	0.35
Z	-	-	0.075
Z1	-	-	0.075
All Dimensions in mm			

Suggested Pad Layout

Please see AP02001 at <http://www.diodes.com/datasheets/ap02001.pdf> for the latest version.

(1) Package Type X2-DFN1410-6

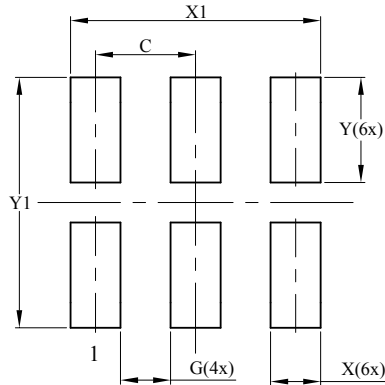

Dimensions	Value (in mm)
C	0.500
G	0.250
X	0.250
X1	1.250
Y	0.525
Y1	1.250

(2) Package Type: X2-DFN1010-6

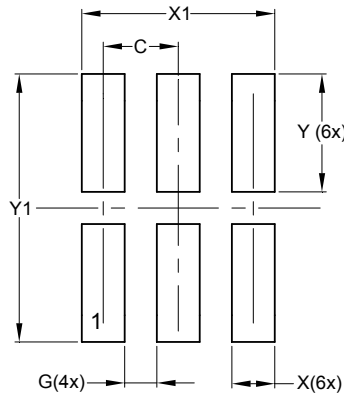

Dimensions	Value (in mm)
C	0.350
G	0.150
X	0.200
X1	0.900
Y	0.550
Y1	1.250

(3) Package Type: X2-DFN0910-6

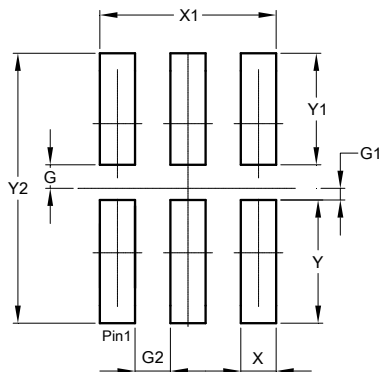

Dimensions	Value (in mm)
G	0.100
G1	0.050
G2	0.150
X	0.150
X1	0.750
Y	0.525
Y1	0.475
Y2	1.150

IMPORTANT NOTICE

DIODES INCORPORATED MAKES NO WARRANTY OF ANY KIND, EXPRESS OR IMPLIED, WITH REGARDS TO THIS DOCUMENT, INCLUDING, BUT NOT LIMITED TO, THE IMPLIED WARRANTIES OF MERCHANTABILITY AND FITNESS FOR A PARTICULAR PURPOSE (AND THEIR EQUIVALENTS UNDER THE LAWS OF ANY JURISDICTION).

Diodes Incorporated and its subsidiaries reserve the right to make modifications, enhancements, improvements, corrections or other changes without further notice to this document and any product described herein. Diodes Incorporated does not assume any liability arising out of the application or use of this document or any product described herein; neither does Diodes Incorporated convey any license under its patent or trademark rights, nor the rights of others. Any Customer or user of this document or products described herein in such applications shall assume all risks of such use and will agree to hold Diodes Incorporated and all the companies whose products are represented on Diodes Incorporated website, harmless against all damages.

Diodes Incorporated does not warrant or accept any liability whatsoever in respect of any products purchased through unauthorized sales channel.

Should Customers purchase or use Diodes Incorporated products for any unintended or unauthorized application, Customers shall indemnify and hold Diodes Incorporated and its representatives harmless against all claims, damages, expenses, and attorney fees arising out of, directly or indirectly, any claim of personal injury or death associated with such unintended or unauthorized application.

Products described herein may be covered by one or more United States, international or foreign patents pending. Product names and markings noted herein may also be covered by one or more United States, international or foreign trademarks.

This document is written in English but may be translated into multiple languages for reference. Only the English version of this document is the final and determinative format released by Diodes Incorporated.

LIFE SUPPORT

Diodes Incorporated products are specifically not authorized for use as critical components in life support devices or systems without the express written approval of the Chief Executive Officer of Diodes Incorporated. As used herein:

A. Life support devices or systems are devices or systems which:

1. are intended to implant into the body, or
2. support or sustain life and whose failure to perform when properly used in accordance with instructions for use provided in the labeling can be reasonably expected to result in significant injury to the user.

B. A critical component is any component in a life support device or system whose failure to perform can be reasonably expected to cause the failure of the life support device or to affect its safety or effectiveness.

Customers represent that they have all necessary expertise in the safety and regulatory ramifications of their life support devices or systems, and acknowledge and agree that they are solely responsible for all legal, regulatory and safety-related requirements concerning their products and any use of Diodes Incorporated products in such safety-critical, life support devices or systems, notwithstanding any devices- or systems-related information or support that may be provided by Diodes Incorporated. Further, Customers must fully indemnify Diodes Incorporated and its representatives against any damages arising out of the use of Diodes Incorporated products in such safety-critical, life support devices or systems.

Copyright © 2013, Diodes Incorporated

www.diodes.com



Компания «ЭлектроПласт» предлагает заключение долгосрочных отношений при поставках импортных электронных компонентов на взаимовыгодных условиях!

Наши преимущества:

- Оперативные поставки широкого спектра электронных компонентов отечественного и импортного производства напрямую от производителей и с крупнейших мировых складов;
- Поставка более 17-ти миллионов наименований электронных компонентов;
- Поставка сложных, дефицитных, либо снятых с производства позиций;
- Оперативные сроки поставки под заказ (от 5 рабочих дней);
- Экспресс доставка в любую точку России;
- Техническая поддержка проекта, помощь в подборе аналогов, поставка прототипов;
- Система менеджмента качества сертифицирована по Международному стандарту ISO 9001;
- Лицензия ФСБ на осуществление работ с использованием сведений, составляющих государственную тайну;
- Поставка специализированных компонентов (Xilinx, Altera, Analog Devices, Intersil, Interpoint, Microsemi, Aeroflex, Peregrine, Syfer, Eurofarad, Texas Instrument, Miteq, Cobham, E2V, MA-COM, Hittite, Mini-Circuits, General Dynamics и др.);

Помимо этого, одним из направлений компании «ЭлектроПласт» является направление «Источники питания». Мы предлагаем Вам помощь Конструкторского отдела:

- Подбор оптимального решения, техническое обоснование при выборе компонента;
- Подбор аналогов;
- Консультации по применению компонента;
- Поставка образцов и прототипов;
- Техническая поддержка проекта;
- Защита от снятия компонента с производства.



Как с нами связаться

Телефон: 8 (812) 309 58 32 (многоканальный)

Факс: 8 (812) 320-02-42

Электронная почта: org@eplast1.ru

Адрес: 198099, г. Санкт-Петербург, ул. Калинина, дом 2, корпус 4, литера А.