

**SERIES 83**  
Unsealed, .500" Centers

**FEATURES**

- 1/2" Button Centers
- Post Mounted
- Mount by Grooveless Retaining Ring or Heat Upset Post
- Snap-Dome Contact Provides Positive Feedback



**DIMENSIONS** In inches (and millimeters)

**3x4 Keyboard**

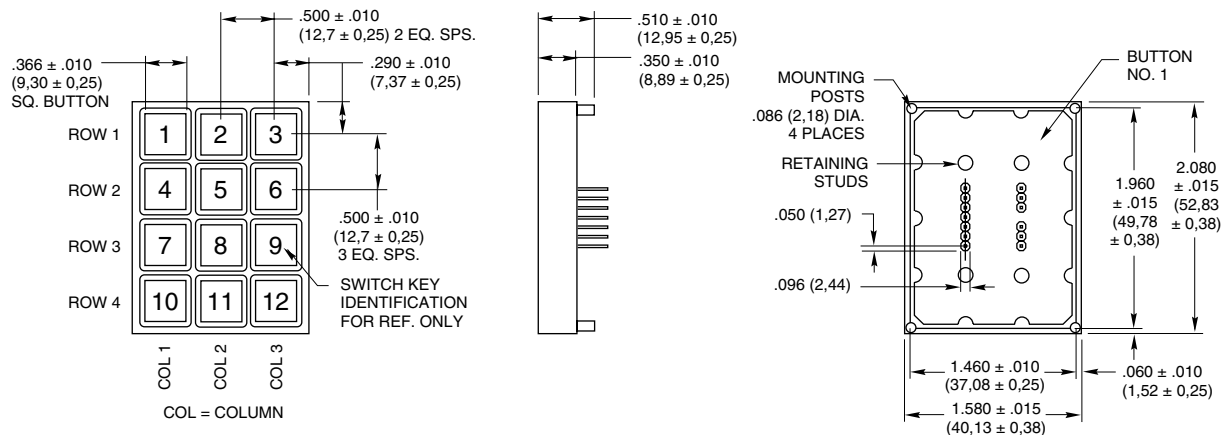

**Termination** In inches (and millimeters)

**3x4**

**Matrix Output**

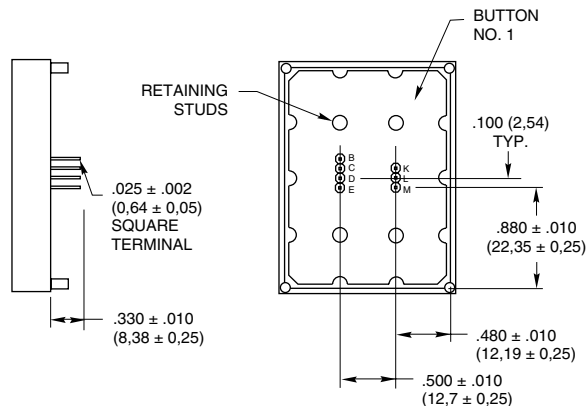

**Single Pole/Common Bus**

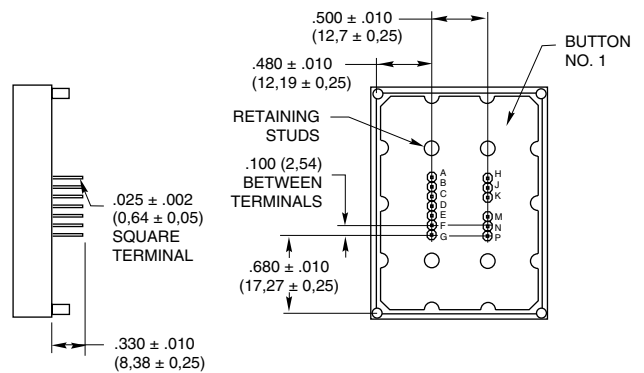

**SERIES 83**  
Unsealed, .500" Centers

**FEATURES**

- 1/2" Button Centers
- Post Mounted
- Mount by Grooveless Retaining Ring or Heat Upset Post
- Snap-Dome Contact Provides Positive Feedback



**DIMENSIONS** In inches (and millimeters)

**4x4 Keyboard**

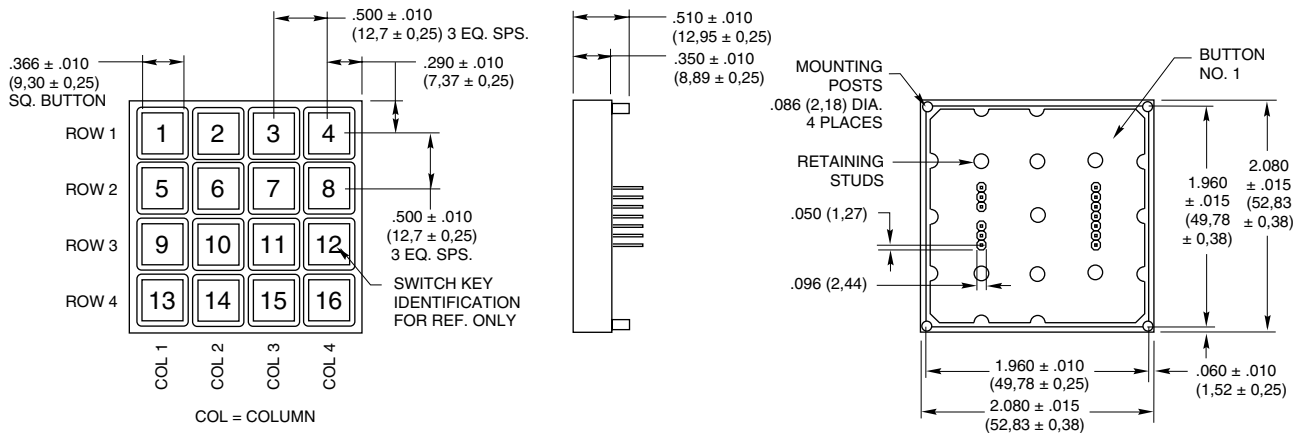

**Termination** In inches (and millimeters)

**4x4 Matrix Output**

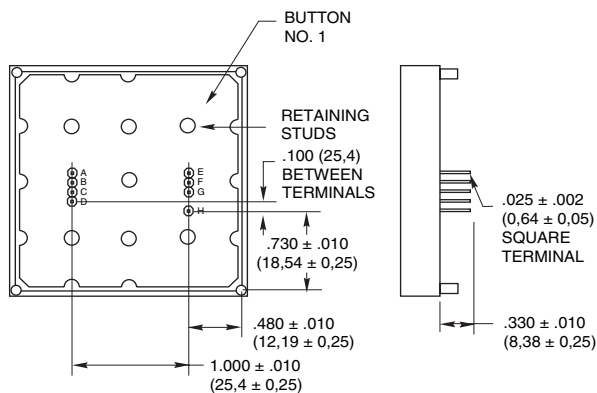

**Single Pole/Common Bus**

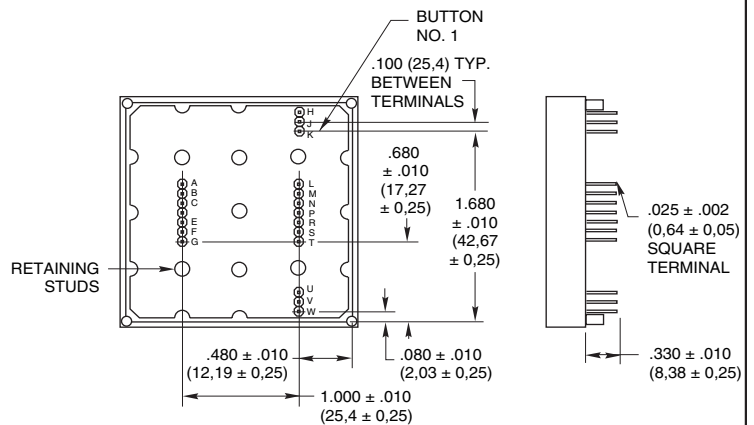

**CODE AND TRUTH TABLES**

Dots in the chart indicate connected terminals when switch is closed.  
Terminals are identified on the keyboard.

**12 Button Keypads**

		CODES																			
		Matrix				Single Pole/Common Bus															
BUTTON LOCATION	1	•																			
	2	•	•																		
	3	•		•																	
	4	•			•																
	5	•	•			•															
	6	•					•														
	7	•						•													
	8	•							•												
	9	•								•											
	10	•									•										
	11	•										•									
	12	•											•								
		K	D	E	B	C	L	M	K	H	A	J	C	B	N	E	F	M	P	G	D
		TERMINAL LOCATION																			

**16 Button Keypads**

		CODES																									
		Matrix				Single Pole/Common Bus																					
BUTTON LOCATION	1	•																									
	2	•	•																								
	3	•		•																							
	4	•			•																						
	5	•	•			•																					
	6	•					•																				
	7	•						•																			
	8	•							•																		
	9	•								•																	
	10	•									•																
	11	•										•															
	12	•											•														
	13	•												•													
	14	•													•												
	15	•														•											
	16	•															•										
		E	F	D	C	A	B	G	H	H	J	K	A	L	M	C	B	T	S	E	F	W	V	U	G	P	
		TERMINAL LOCATION																									

**SPECIFICATIONS****Rating Criteria****Rating at 24 Vdc:** 10 milliamps, resistive**Contact Resistance:** Compatible with MOS, TTL and DTL (10 ohms maximum)**Voltage Breakdown:** 250 Vac between mutually insulated parts**Life Expectancy:** 3,000,000 operations per button**Contact Bounce:** Less than 4 milliseconds at make, 10 milliseconds at break**Operating Temperature:** -40°C to +80°C**Materials and Finishes****Housing:** ABS polycarbonate, black**Buttons:** ABS plastic, white. Legends are black.**Snap-On-Cap:** Clear polycarbonate**Contact Dome:** Stainless steel, selectively gold-plated**Terminals:** Phosphor bronze**Operating Features****Button Travel:** 0.015" (0,38 mm) nominal total travel**Typical Operating Force:** 350 grams**STANDARD LEGENDS**

Insertable legend version (legend numbers -101 and -001) has a removable cap. The revealed button surface can be legended by an insert or a dry transfer of a blank legend

insert. This surface can also be ink stamped by Grayhill in higher volume quantities. When the cap is replaced, the assembly extends approximately .015" (0,38 mm) above the

surface. The legend sheet information follows the legend presentation. All other legends incorporate molded-in (two shot) legends.



-101 (Insertable)

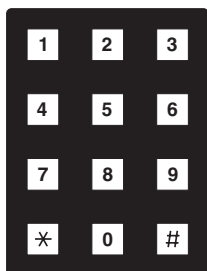

-102 (Molded-in)

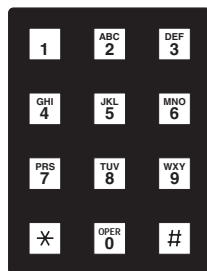

-103 (Molded-in)

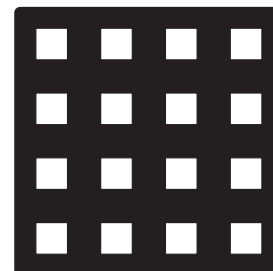

-001 (Insertable)

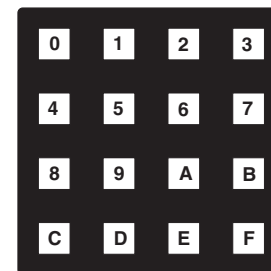

-002 (Molded-in)

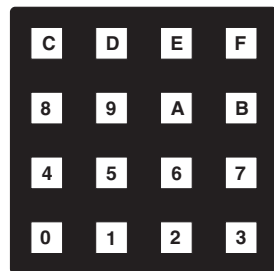

-003 (Molded-in)

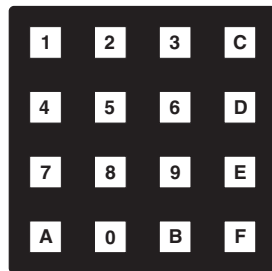

-004 (Molded-in)

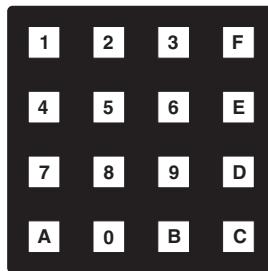

-005 (Molded-in)

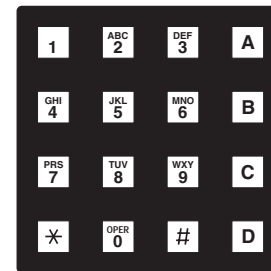

-006 (Molded-in)

### INSERTABLE LEGEND SHEETS

For use with -101 or -001 legend option. Legends are die cut to fit button surface when cap is removed. Dry transfer legends offer some flexibility to customize the blank inserts included on the sheet of popular legend letters, words and symbols provided or on the insertable legends sheet.

Description	Part No.
Sheet of Legend Inserts Dry Transfer Lettering, Small Dry Transfer Lettering, Medium Dry Transfer Lettering, Large	<b>87AC2046</b> <b>87-DT-2096-088</b> <b>87-DT-2096-125</b> <b>87-DT-2096-187</b>

For prices and discounts, contact a local Sales Office, an authorized local Distributor or Grayhill.

### PRINTED LEGENDS

#### For Maximum Versatility

Printing allows you the flexibility to create your own legend using whole words and symbols with various type styles. Durable epoxy ink printing bonds to the button cap surface. There are two types of button cap printing:

**Top Surface Printing:** Legend is applied directly to the top of the button. Button is recessed slightly below the keyboard housing.

**Sub-Surface Printing:** For insertable legend models. Provides maximum wear for printed surfaces. Printed internal button cap is protected by clear snap-on cap.

**Printed Typestyles:** The typestyle chart illustrates type style, size and approximate character limits for button caps. Grayhill's library of typefaces includes most popular legends.

Type No. and Typical Height	Sample Style and Typical Sizes	Sub Surface Character and Line Limitations	Top Surface Character and Line Limitations
<b>4GH088</b> .083"	ABCDEFGH	4 Characters 2 Lines 	4 Characters 2 Lines 
<b>1GH125</b> .138"	ABCDE	3 Characters 1 Line 	3 Characters 1 Line 
<b>3GH187</b> .207"	ABCD	2 Characters 1 Line 	2 Characters 1 Line 
<b>2GH250</b> .276"	ABC	N/A N/A	2 Characters 1 Line 

### ORDERING INFORMATION:

#### Special Legends

Follow this procedure:

- 1. Basic Keyboard.** Formulate the part number with the exception of the legend suffix.
- 2. Mounting.** Standard mounting is shown in our dimensional drawings. These drawings relate the terminal location to the button legend orientation. It is possible to rotate the button legends by 90°, changing the orientation. When mounting the keypad, it would be rotated 90° to have the legends appear upright. A 3x4 keypad thus becomes a 4x3.
- 3. Color.** Many colors, other than our standard black housing, are available. Buttons can be made from equivalent plastic in black, red, green, blue and yellow. White legends are used with dark color buttons, black with light ones. Other colors available on special order.
- 4. Buttons.** Legends can be printed on button surface and protected by a snap-on cap in a similar fashion to our insertable legend types. A second option is printing a 'blank' button. (One that has the same dimensions as a molded-in legend button with a flat top surface.) Disadvantage is legend wear over time. A third option is molded-in legends, usually requiring tooling. Molded buttons are available with a flat or concave top surface.
- 5. Legends.** Specify the legend requirements for each button. Identify buttons per our dimensional drawings. Caution if keypad has been rotated.

### ORDERING INFORMATION

**83AB1-103**

- Grayhill Series Number**
- Size Option**  
A = 3x4  
B = 4x4
- Circuitry Option**  
B1 = Matrix code  
C1 = Single pole/common bus
- Standard Legend Choices**  
3x4 Size: -101, -102 or -103  
4x4 Size: -001, -002, -003, -004, -005 or -006

Available from your local Grayhill Distributor. For prices and discounts, contact a local Sales Office, an authorized local Distributor or Grayhill.



Компания «ЭлектроПласт» предлагает заключение долгосрочных отношений при поставках импортных электронных компонентов на взаимовыгодных условиях!

Наши преимущества:

- Оперативные поставки широкого спектра электронных компонентов отечественного и импортного производства напрямую от производителей и с крупнейших мировых складов;
- Поставка более 17-ти миллионов наименований электронных компонентов;
- Поставка сложных, дефицитных, либо снятых с производства позиций;
- Оперативные сроки поставки под заказ (от 5 рабочих дней);
- Экспресс доставка в любую точку России;
- Техническая поддержка проекта, помощь в подборе аналогов, поставка прототипов;
- Система менеджмента качества сертифицирована по Международному стандарту ISO 9001;
- Лицензия ФСБ на осуществление работ с использованием сведений, составляющих государственную тайну;
- Поставка специализированных компонентов (Xilinx, Altera, Analog Devices, Intersil, Interpoint, Microsemi, Aeroflex, Peregrine, Syfer, Eurofarad, Texas Instrument, Miteq, Cobham, E2V, MA-COM, Hittite, Mini-Circuits, General Dynamics и др.);

Помимо этого, одним из направлений компании «ЭлектроПласт» является направление «Источники питания». Мы предлагаем Вам помощь Конструкторского отдела:

- Подбор оптимального решения, техническое обоснование при выборе компонента;
- Подбор аналогов;
- Консультации по применению компонента;
- Поставка образцов и прототипов;
- Техническая поддержка проекта;
- Защита от снятия компонента с производства.



#### Как с нами связаться

**Телефон:** 8 (812) 309 58 32 (многоканальный)

**Факс:** 8 (812) 320-02-42

**Электронная почта:** [org@eplast1.ru](mailto:org@eplast1.ru)

**Адрес:** 198099, г. Санкт-Петербург, ул. Калинина, дом 2, корпус 4, литера А.