

# heavy | mate<sup>®</sup>

## Heavy Duty Connectors



# Note from the CEO



## Ladies and Gentlemen,

For over 75 years Amphenol has enjoyed success as the interconnection technology provider of choice to industry-leading companies around the world. One of our key strategic areas of focus has been and is the Industrial market. Our organization works with leading manufacturers across a wide range of applications - including Energy Generation & Distribution, Transportation, Heavy Equipment, Factory Automation, Wireless Outdoor, ChipCard Readers - enabling smarter, faster and better technologies to connect products to customer solutions.

The Industrial market footprint of Amphenol covers over facilities in more than 12 different European countries and more than 30 countries worldwide. Our successful expansion into new regions as well as new industrial applications is a direct reflection of our agile, entrepreneurial management team and our unwavering commitment to execute Amphenol's strategies for the benefit of our customers, shareholders and employees.

Thank you for partnering with Amphenol. Our entire organization is at your service.

A handwritten signature in black ink, appearing to read 'R. Adam Norwitt'. The signature is fluid and cursive, with a long horizontal stroke at the end.

R. Adam Norwitt  
President and CEO, Amphenol Corporation

# Make use of the best

## Use our global resources

“Think global, act local!” Independently from where you are in Europe, we offer you our global expertise and great variety of products and technologies. And in comfort with your personal contact. Our numerous European offices are your access to our global resources.

### ● OUR OFFICES IN EUROPE AND WORLDWIDE

---

FRANCE	CHINA	AUSTRALIA	SOUTH AFRICA
GERMANY	KOREA	MEXICO	INDIA
UNITED KINGDOM	TAIWAN	USA	ITALY





SECURITY, RELIABILITY AND COMFORTABLE SERVICE FROM ONE SOURCE.

# More time for important things: benefit from our service and diversity

Enjoy security, reliability and comfortable service from one source. INDUSTRIAL@AMPHENOL offers one of the most individual and most diversified service programmes in the market – exclusively for industrial customers. Access all possibilities of the Amphenol group through your personal expert adviser.



## WIDE PRODUCT RANGE

Take advantage of a choice of Amphenol products. Our broad product portfolio offers individual solutions from more than 85 member companies in the global Amphenol group.



## EXCLUSIVENESS AND FLEXIBILITY

One face to the customer: every inquiry is handled on an individual service level by your personal key account service partner. This ensures maximum transparency and best-in-class flexibility in the whole process.



## QUALITY

Interconnect systems need reliability, speed and flawless data transmission. We continuously test and guarantee the required standard in our products – and also in our personal services.



## INDIVIDUAL SOLUTIONS

Your project requires an individual solution that is not available off-the-shelf? As your think tank and discussion partner we provide engineering support and solution-oriented development for your tailor-made Amphenol product.



## SPEED AND AVAILABILITY

Smart and intelligent processes are the secret behind our service programme. Flexible planning and distribution, perfect logistics and highest availability are our key factors for best customer service.



## GLOBAL KEY ACCOUNT SERVICE

Our key account service is your individual entrance to global know-how, products and services. More than 85 Amphenol companies around the world offer an extensive range of technologies and products. We offer access to our worldwide resources through one individual contact person.

# heavy|mate<sup>®</sup> is a Modular Metal Connector Line

## What is heavy|mate<sup>®</sup> ?

heavy|mate<sup>®</sup> is a modular connector line, consisting of:

- Hoods & Housings
- Inserts
- Contacts

## Why heavy|mate<sup>®</sup> ?

- Connections in harsh industrial environment
- Robust design necessary
- High number of poles or different kinds of signals transmitted
- Very good EMC protection required
- Power and signal transmission outdoor
- Very save locking system required

# for Applications in Industrial Environments.



## Major product features

- Hybrid interconnections
- Good costs
- Voltage up to 1000V
- VDE, UL, CSA approvals
- Vibration proof
- High current
- Signal transmission
- High pole sizes
- IP65 to IP68
- Corrosion resistance
- Robust



## What can heavy | **mate**<sup>®</sup> offer?

- Connectors for industrial applications indoor & outdoor
- A wide range of inserts for signal and power transmission
- A large variety in pole sizes from 3 up to 280 poles per connector
- Current ratings up to 250A per contacts and voltages up to 1000V
- A modular connector system to configure customized solutions

# How to select a solution with series heavy | mate®.

## Theory

- Select an insert that meets your requirements.
- Choose the related contacts if not included in inserts.
- Choose related housings.
- Choose related cable gland.
- If you are interested in a cable assembly, please ask us.

## Practice 1

### Requirements

- 250V
- 5A
- 60 contacts
- Termination: crimp

### Solution

- Check: Make a pre-selection on the overview page of the series, s. p. 10/11  
Possible series: heavy | mate® D, DD and M
- Check: Details on the overview pages of the sub-series, see pages 22, 38, 114  
All 3 variants are possible; Selection heavy | mate® D
- Check: Contact inserts on the detail page of the sub-series  
Selection: C146 10A064 000 2
- Check: Contacts on the same double page  
Selection: VN01 016 0002 1
- Check: Housings via crosslink at contact inserts  
Selection: C146 21R024 600 8
- Check: Gland bushing via crosslink at housings  
Selection: VN16 320 0126X





## Practice 2

### Requirements

- 3 x 400V; 50A; 6mm<sup>2</sup> wire gauge
- 8 x 250V; 8A; 1.5mm<sup>2</sup> wire gauge
- 5 x 400V; 15A; 4mm<sup>2</sup> wire gauge

### Solution

- **Check:** Make a pre-selection on the overview page of the series, see pages 10/11  
Possible series: heavy | **mate**<sup>®</sup> M
- **Check:** How 16 contacts can be realized, see modules overview on page 118  
Possible selection: a) 1 x 20 contacts  
b) 2 x 10 contacts  
c) 1 x 10 contacts + 1 x 5 contacts  
d) 1 x 3 contacts + 1 x 5 contacts + 1 x 10 contacts
- **Check:** Technical parameters / solution, see detail pages of the modules on page 126  
Possible selection: a) not possible due to voltage  
b) not possible due to voltage  
c) not possible due to current  
d) POSSIBLE
- **Check:** Choose matching contact, see detail page of the modules on page 126  
Possible selection: a) C146 A03 001 E8 - VN01 036 0002 1C  
b) C146 A0 001 E8 - VN01 025 0033 1C  
c) C146 A10 001 E8 - VN01 016 0027 1XC
- **Check:** Choose matching frame, see frames on page 124  
Solution: C146 P10 001 G8
- **Check:** Choose matching housing, see housings on page 162  
Solution: C146 21R010 600 8

# Make your selection out of the heavy | mate<sup>®</sup> series!

Series Characteristic	A page 14	D page 22	DD page 38	E page 44	EE page 62	E / FE / KO page 68	F page 74
<b>Voltage</b>							
250V	●	●	●	●	●	●	●
400V	●			●	●	●	●
500V				●	●		●
690V							●
830V							●
1000V							
<b>Current</b>							
10A	●	●	●	●	●	●	●
16A	●			●	●		●
35A							●
80A							●
100A							
200A							
<b>Numbers of contacts</b>				<b>Modules for</b>			
	3	7	24	6	10	6	3
	4	8	42	10	18	10	6
	10	15	72	16	32	16	8
	16	25	108	24	46	24	12
		40					17
		64					20
<b>Termination</b>							
Crimp		●	●	●	●		●
Screw	●			●		●	
Tension spring				●			

Cross reference list see [www.amphenol.de/xref/](http://www.amphenol.de/xref/)

HSE page 94	HvE page 98	K page 108	M page 114	Q page 156	Housings page 162	Accessories page 223	Series Characteristic
<b>Voltage</b>							
●	●	●	●	●			250V
●	●	●	●	●			400V
	●	●	●	●			500V
	●	●	●				690V
		●	●				830V
			●				1000V
<b>Current</b>							
●	●	●	●	●			10A
●	●	●	●	●			16A
●		●	●				35A
		●	●				80A
			●				100A
			●				200A
<b>Modules for</b>				<b>Numbers of contacts</b>			
6	3+2 6+2 10+2 16+2	4 / 0 4 / 2 6 / 36	1 2 3 4 5 10 20	5 7			
<b>Termination</b>							
		●	●	●			Crimp
●	●	●					Screw
							Tension spring

# The highlights of the series heavy|mate®.

## Contact technology

- Turned contacts, which correspond to the market standard.
- Turned female contacts of copper for higher current-carrying capacity – specifically for the modular system heavy|mate® M.
- Radsok contact technology: These are laminated contacts with very low transition resistance, suitable for high current applications.
- Stamped contacts with high performance for semi-automatic processing at great cost savings.
- Selectively coated gold plating stamped contacts offer great savings.



## Housings

Surface coatings available in two versions: Standard or High-End with a salt mist resistance up to 500 hours.

Flexible cable entry in different positions – possible on request.

Robust metal levers in 1 and 2 locking-lever-system.

Quality EMC solutions.

Tightness classes in IP65, IP67 or IP68!



# Modular system

With the new series heavy|mate® F Amphenol offers a new modular system that is compatible with the market leader. With the series heavy|mate® M Amphenol offers a system with many benefits:

- More module slots in the connector.
- Large selection of contact-safe male contacts
- Stamped contacts and the Radsok contact technology
- Great cost savings potential





The background of the entire page is a dynamic industrial scene. In the upper portion, there's a close-up of a mechanical assembly with two circular gauges and various bolts. Below this, a large volume of bright orange and yellow sparks is being ejected from a dark, metallic surface, likely a grinding or cutting process. The overall lighting is a mix of cool blues and warm oranges, creating a sense of intense industrial activity.

# heavy | mate<sup>®</sup> A

- Rated voltage 250 / 400 V
- Rated current 14 A ... 18 A
- Termination: screw
- Number of contacts: 3, 4, 10, 16, 32



Approvals, Testhouse	Characteristics	Approval-Number
SEV 	250 V, 10 A	
UL 	600 V, 14 A	E 63093
CSA 	600 V, 10 A; 16 A; 20 A	LR 700721

In general approvals refer to representative versions of the connector series. Extent and specification of tests upon request.

## General information

- For series heavy|mate® A connectors may be engaged or disengaged when live but without electrical load. If these connectors are used as plug and socket device, the load shall be reduced to 10 % of the rated current.

- Low and high profile housing for heavy|mate® A series inserts for 10 and 16 contacts.



## No standard for this series, but:

- Interchangeable with other makes
  - contact insert to contact insert
  - contact insert to housing 10 ,16 contacts

Housings are designed according to DIN EN 175 301 - 801

## First-to-mate last-to-break protective ground contact

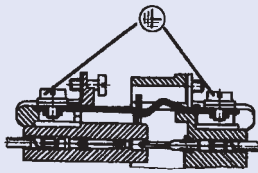

## Range of housings

Size A3/4



Size A10



Size A16









## heavy|mate® A Characteristics contact inserts

General Characteristics	Standard	Value			
Number of contacts		3/4 + ⊕	10 + ⊕	16 + ⊕	32 + ⊕
Termination technique		screw			
Wire gauge		0.25 - 2.5 mm <sup>2</sup>			
Flammability	UL 94	V-0			
Electrical Characteristics					
Rated voltage	IEC 60664-1	400 V	250 V		
Pollution degree	IEC 60664-1	3			
Installation (overvoltage) category	IEC 60664-1	III			
Material group	IEC 60664-1	III b			
Rated impulse withstand voltage	IEC 60664-1	4 KV			
Current carrying capacity	IEC 60512-5-2	see derating curves			
Rated current T <sub>amp</sub> = 40 °C		18 A	16 A	14 A	14 A
Contact resistance	IEC 60512-2-1	≤ 5 m Ω			
Insulation resistance	IEC 60512-3-1	≥ 10 <sup>10</sup> Ω			
Climatical Characteristics					
Climatic category	IEC 60068-1	40 / 100 / 21			
Upper temperature	IEC 60512-11-9	+ 100 °C			
Lower temperature	IEC 60512-11-10	- 40 °C			
Mechanical Characteristics					
IP-degree of protection pin insert <sup>1)</sup>	IEC 60529	unmated IP00		mated IP20	
IP-degree of protection socket insert <sup>1)</sup>	IEC 60529	unmated IP20		mated IP20	
Weight pin insert		13 g	48 g	68 g	136 g
Weight socket insert		13 g	52 g	73 g	146 g
Mechanical operation	IEC 60512-9-1	≥ 500 mating cycles			
Materials					
Insert		PA	PBT	PBT	PBT
Contacts		Cu Zn (brass)			
Contact plating		Ag (silver)			

Description	Part Number	Drawing	Figure
<b>Contact insert 3 + ⊕</b>			
Male insert for screw termination	C146 10A003 002 4		
Female insert for screw termination	C146 10B003 002 4		

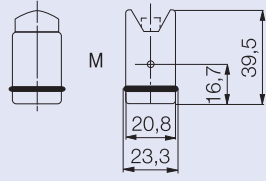
**Pin layout**

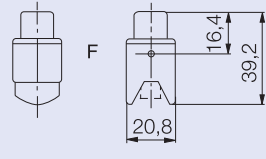

Description	Part Number	Drawing	Figure
<b>Contact insert 4 + ⊕</b>			
Male insert for screw termination	C146 10A004 002 4		
Female insert for screw termination	C146 10B004 002 4		

**Pin layout**



**Derating curves**



Curve	Wire gauge
a	1.5 mm <sup>2</sup>
b	2.5 mm <sup>2</sup>

Description	Part Number	Drawing	Figure
<b>Contact insert 10 + ⊕</b>			
Male insert for screw termination	C146 10A010 002 4		
Male insert with wire protection for screw termination	C146 10A010 102 4		
Female insert for screw termination	C146 10B010 002 4		
Female insert with wire protection for screw termination	C146 10B010 102 4		

**Pin layout** **Assembly instruction**

<p>Male insert</p>	<p>Female insert</p>	<p>Panel cut out (insert)</p>	
--------------------	----------------------	-------------------------------	--

**Derating curves**

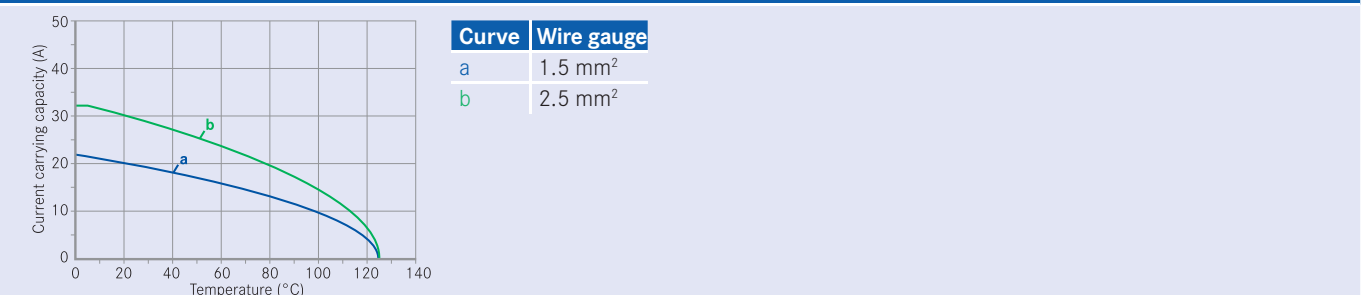

Description	Part Number	Drawing	Figure
<b>Contact insert 16 + ⊕</b>			
Male insert for screw termination	C146 10A016 002 4		
Male insert with wire protection for screw termination	C146 10A016 102 4		
Female insert for screw termination	C146 10B016 002 4		
Female insert with wire protection for screw termination	C146 10B016 102 4		

**Pin layout**

**Assembly instruction**

Male insert

Female insert

Panel cut out (insert)

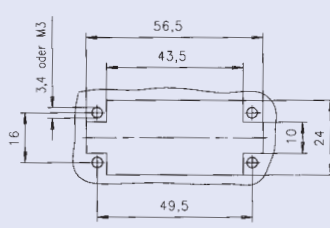

**Derating curves**



Curve	Wire gauge
a	1.5 mm <sup>2</sup>
b	2.5 mm <sup>2</sup>

Description	Part Number	Drawing	Figure
<b>Contact insert 32 + ⊕</b>			
Male insert for screw termination	C146 10A016 002 4 (1 - 16) + C146 10A016 004 4 (17 - 32)		
Male insert with wire protection for screw termination	C146 10A016 102 4 (1 - 16) + C146 10A016 104 4 (17 - 32)		
Female insert for screw termination	C146 10B016 002 4 (1 - 16) + C146 10B016 004 4 (17 - 32)		
Female insert with wire protection for screw termination	C146 10B016 102 4 (1 - 16) + C146 10B016 104 4 (17 - 32)		

**Pin layout**



**Assembly instruction**

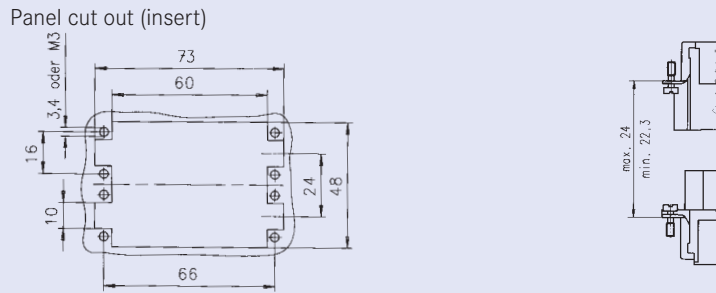

**Derating curves**

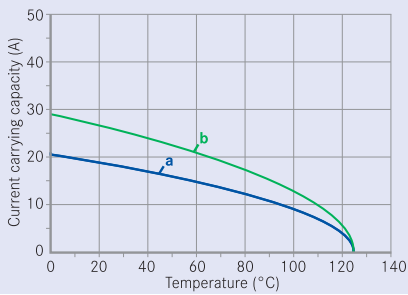



Curve	Wire gauge
a	1.5 mm <sup>2</sup>
b	2.5 mm <sup>2</sup>



# heavy | mate<sup>®</sup> D

- Rated voltage 250 V
- Rated current 10 A ... 16 A
- Termination: crimp
- Number of contacts: 7, 15, 25, 40, 50, 64, 128



Approvals, Testhouse	Characteristics	Approval-Number
SEV 	250 V, 10 A	
UL 	600 V, 14 A 600 V, 15 A (high current)	E 63093
CSA 	600 V, 10 A	48932

In general approvals refer to representative versions of the connector series. Extent and specification of tests upon request.

**General information**

- Contact inserts without crimp contacts, crimping tools see separate catalogue „Tools“.
- Contacts must be ordered separately, processing instructions see catalogue „Tools“.
- We recommend using the high profile housings / hoods for the heavy|mate® D inserts.
- Connectors series heavy|mate® D may be engaged or disengaged when live but without electrical load.  
If these connectors are mated or unmated under load, the load shall be reduced to 10 % of the rated current.
- For contact inserts for turned contacts, guide pins and guide socket are recommended (see page 226).
- By using contact inserts with two PE-connections without hoods, it is necessary to connect the facing of each PE-connection.
- If connectors are mounted in non conductive housings both protective earthing terminals shall be mounted.



**Standardised connectors according to DIN EN 175 301 - 801 (DIN 43652)**

Interchangeable with all other products which are according to the standard.

- a) Contact insert to contact insert 15, 25, 40, 64 way.
- b) Contact insert to housing 15, 25, 40, 64 way.

**High protection against mismatching**

- Female inserts with funnel shaped contact entry avoids mismatching with stamped contacts.



**First-to-mate last-to-break protective ground contact**



**Contact inserts for stamped contacts and for turned contacts**

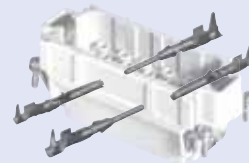

**Range of housings**

Size A3/4	Size A10	Size A16
Size E16	Size E24	Size E48



Modified contact arrangement for rated voltages of 400 V

(15) → 7 + ⊕



Female insert Male insert

(25) → 11 + ⊕



Female insert Male insert

(40) → 20 + ⊕

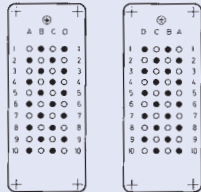

Female insert Male insert

(64) → 32 + ⊕

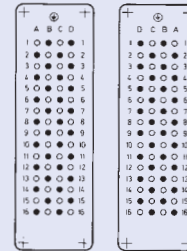

Female insert Male insert

- full load contact
- unoccupied

Removal of contacts, front releas

stamped male contacts  
all turned contacts



stamped female contacts



## heavy|mate® D Characteristics contact inserts

General Characteristics	Standard	Value							
Number of contacts		7	15	25	40	50 2x25	64	128 2x64	
Contact arrangement	DIN EN 175 301-801 (DIN 43652)		•	•	•		•		
Termination technique		crimp, wire wrap							
Max. wire diameter		4.1 mm							
Flammability	UL 94	V-0							
Electrical Characteristics									
Rated voltage <sup>1)</sup>	IEC 60664-1	250 V~ (400 V~ <sup>2)</sup> ) (600 V UL / CSA <sup>3)</sup> )							
Pollution degree	IEC 60664-1	3							
Installation (overvoltage) category	IEC 60664-1	III							
Material group	IEC 60664-1	III b							
Rated impulse withstand voltage	IEC 60664-1	4 kV							
Rated current	IEC 60512-5-2	see derating curves							
Rated current T <sub>amp</sub> = 40 °C		16 A	12 A	12 A	10 A	10 A	10 A	10 A	
Insulation resistance	IEC 60512-3-1	≥ 10 <sup>10</sup> Ω							
Climatical Characteristics									
Climatic category	IEC 60068-1	40/125/21							
Upper temperature	IEC 60512-11-9	+ 125°C							
Lower temperature	IEC 60512-11-10	- 40°C							
Mechanical Characteristics									
IP-degree of protection pin insert	IEC 60529	unmated IP00				mated IP20			
IP-degree of protection socket insert	IEC 60529	unmated IP20				mated IP20			
Weight pin insert		8 g	28 g	34 g	53 g	68 g	65 g	130 g	
Weight socket insert		8 g	30 g	38 g	64 g	76 g	82 g	164 g	
Mechanical operation	IEC 60512-9-1	≥ 500 mating cycles							
Materials									
Insert	IEC 60664-1	PBTP	PC GV <sup>4)</sup>						
Colour insert	IEC 60664-1	grey							

Description	Part Number	Drawing	Figure
<b>Contact insert 7 + ⊕, 42 V~ in metal housings/250 V in thermoplastic housings (Please order contacts separately, see page 34)</b>			
Male insert for stamped crimp contacts	C146 10A007 000 2		
Male insert for turned crimp contacts	C146 10A007 500 2		
Female insert for stamped crimp contacts	C146 10B007 000 2		
Female insert for turned crimp contacts	C146 10B007 500 2		

**Pin layout**



Description	Part Number	Drawing	Figure
<b>Contact insert 8, 42 V~ in metal housings/250 V in thermoplastic housings (Please order contacts separately, see page 34)</b>			
Male insert for stamped crimp contacts	C146 10A008 000 2		
Male insert for turned crimp contacts	C146 10A008 500 2		
Female insert for stamped crimp contacts	C146 10B008 000 2		
Female insert for turned crimp contacts	C146 10B008 500 2		

**Pin layout (Note: For use up to 42 V~, the PE contact can be used as regular contact.)**



**Derating curves**

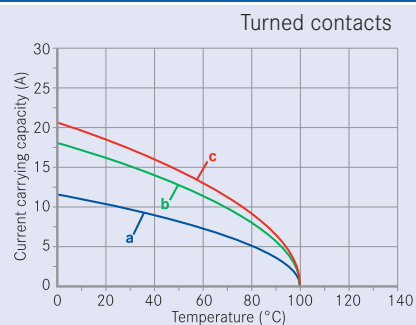

**Description** | **Part Number** | **Drawing** | **Figure**

**Contact insert 15 + ⊕ (Please order contacts separately, see page 34)**

Male insert for stamped crimp contacts	C146 10A015 000 2		
Male insert for turned crimp contacts	C146 10A015 500 2		
Female insert for stamped crimp contacts	C146 10B015 000 2		
Female insert for turned crimp contacts	C146 10B015 500 2		

**Contact insert 15 + ⊕, 2 x PE-termination (Please order contacts separately, see page 34)**

Male insert for stamped crimp contacts	C146 10A015 060 2		
Female insert for stamped crimp contacts	C146 10B015 060 2		

**Pin layout** | **Assembly instruction**

Male insert	Female insert	Panel cut out (insert)	

**Derating curves**



Description	Part Number	Drawing	Figure
<b>Contact insert 25 + ⊕ (Please order contacts separately, see page 34)</b>			
Male insert for stamped crimp contacts	C146 10A025 000 2		
Male insert for turned crimp contacts	C146 10A025 500 2		
Female insert for stamped crimp contacts	C146 10B025 000 2		
Female insert for turned crimp contacts	C146 10B025 500 2		

<b>Contact insert 25 + ⊕ , 2 x PE-termination (Please order contacts separately, see page 34)</b>			
Male insert for stamped crimp contacts	C146 10A025 060 2		
Female insert for stamped crimp contacts	C146 10B025 060 2		

Pin layout		Assembly instruction	
Male insert	Female insert	Panel cut out (insert)	



**Description** | **Part Number** | **Drawing** | **Figure**

**Contact insert 40 + ⊕ (Please order contacts separately, see page 34)**

Male insert for stamped crimp contacts	C146 10A040 000 2		
Male insert for turned crimp contacts	C146 10A040 500 2		
Female insert for stamped crimp contacts	C146 10B040 000 2		
Female insert for turned crimp contacts	C146 10B040 500 2		

**Contact insert 40 + ⊕, 2 x PE-termination (Please order contacts separately, see page 34)**

Male insert for stamped crimp contacts	C146 10A040 060 2		
Female insert for stamped crimp contacts	C146 10B040 060 2		

**Pin layout** | **Assembly instruction**

Male insert	Female insert	Panel cut out (insert)	

**Derating curves**



Description	Part Number	Drawing	Figure
<b>Contact insert 50 + ⊕ (Please order contacts separately, see page 34)</b>			
Male insert for stamped crimp contacts	C146 10A025 000 2 + C146 10A025 005 2		
Male insert for turned crimp contacts	C146 10A025 500 2 + C146 10A025 505 2		
Female insert for stamped crimp contacts	C146 10B025 000 2 + C146 10B025 005 2		
Female insert for turned crimp contacts	C146 10B025 500 2 + C146 10B025 505 2		

**Pin layout**

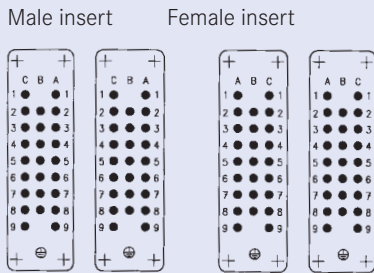

**Assembly instruction**

Panel cut out (insert)

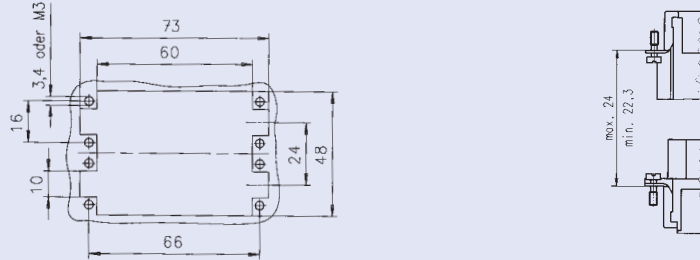

**Derating curves**

Stamped contacts

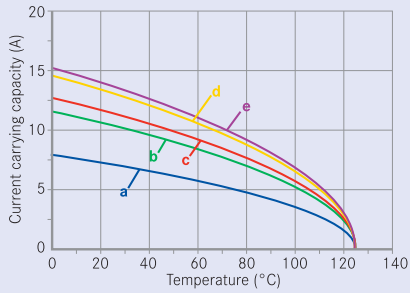

Curve	Wire gauge
a	0.5 mm <sup>2</sup>
b	1.5 mm <sup>2</sup>
c	2.5 mm <sup>2</sup>
d	1.5 mm <sup>2</sup> (High current)
e	2.5 mm <sup>2</sup> (High current)

Turned contacts

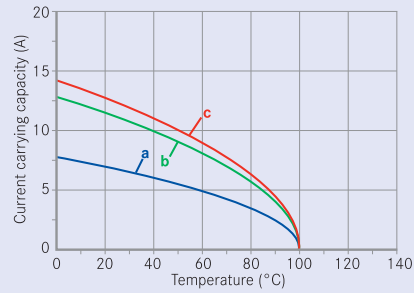

Curve	Wire gauge
a	0.5 mm <sup>2</sup>
b	1.5 mm <sup>2</sup>
c	2.5 mm <sup>2</sup>

**Description** | **Part Number** | **Drawing** | **Figure**

**Contact insert 64 + ⊕ (Please order contacts separately, see page 34)**

Male insert for stamped crimp contacts	C146 10A064 000 2		
Male insert for turned crimp contacts	C146 10A064 500 2		
Female insert for stamped crimp contacts	C146 10B064 000 2		
Female insert for turned crimp contacts	C146 10B064 500 2		

**Contact insert 64 + ⊕, 2 x PE-termination (Please order contacts separately, see page 34)**

Male insert for stamped crimp contacts	C146 10A064 060 2		
Female insert for stamped crimp contacts	C146 10B064 060 2		

**Pin layout** | **Assembly instruction**

Male insert	Female insert	Panel cut out (insert)	

**Derating curves**







Large range of wire gauges

.N01 016 0003 (1)



.N01 016 0002 (1)



.N01 016 0005 (1)



Gas-tight (coldwelding)

0.14

0.25

0.5



0.5

1.0

1.5



1.5

2.5



Stamped crimp contacts with insulation crimp, to absorb mechanical stress from the crimped connection

Insulation grip

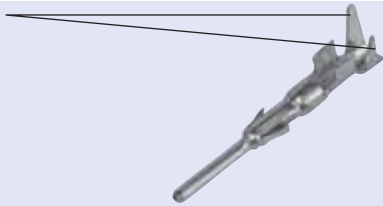

Mechanical retention spring stop on female and male contact

Female contact



Male contact

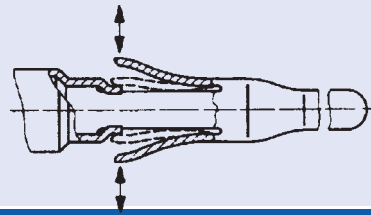

High current carrying capacity

Example single contact



Curve a: 2.5 mm<sup>2</sup> Standard contact. wire gauge



Curve a: 2.5 mm<sup>2</sup> High current contact, wire gauge

Stamped crimp contacts		
<b>Electrical Characteristics</b>		
Contact resistance	IEC 60512-2-1	≤ 5 m Ω
<b>Climatical Characteristics</b>		
Upper temperature	IEC 60512-11-9	+ 125 °C
Lower temperature	IEC 60512-11-10	- 40 °C
<b>Mechanical Characteristics</b>		
Mechanical operation	IEC 60512-9-1	≥ 500 mating cycles
<b>Materials</b>		
Male contact		Cu Zn (brass)
Female contact		Cu Sn (tin bronze)
Contact plating		Ag (silver) / Au (gold)
Turned crimp contacts		
<b>Electrical Characteristics</b>		
Contact resistance	IEC 60512-2-1	≤ 5 m Ω
<b>Climatical Characteristics</b>		
Upper temperature	IEC 60512-11-9	+ 100 °C
Lower temperature	IEC 60512-11-10	- 40 °C
<b>Mechanical Characteristics</b>		
Mechanical operation	IEC 60512-9-1	≥ 500 mating cycles
<b>Materials</b>		
Male contact		Cu Zn (brass)
Female contact		Cu Zn (brass)
Contact plating		Ag (silver) / Au (gold)

## heavy|mate® D Stamped crimp contacts

Supplied as	for wire gauge	AWG	Pieces	Part Number		Figure
				Male contact	Female contact	
<b>Stamped single contacts</b>						
silver plating standard	0.14 - 0.5 mm <sup>2</sup>	26 - 20	100	VN01 016 0003 (1)	VN02 016 0003 (1)	
	0.5 - 1.5 mm <sup>2</sup>	20 - 16	100	VN01 016 0002 (1)	VN02 016 0002 (1)	
	1.5 - 2.5 mm <sup>2</sup>	16 - 14	100	VN01 016 0005 (1)	VN02 016 0005 (1)	
silver plating high current	0.5 - 1.5 mm <sup>2</sup>	20 - 16	100	VN01 016 0015 (1)	VN02 016 0015 (1)	
	1.5 - 2.5 mm <sup>2</sup>	16 - 14	100	VN01 016 0016 (1)	VN02 016 0016 (1)	
gold plating standard	0.14 - 0.5 mm <sup>2</sup>	26 - 20	100	VN01 016 0003 (2)	VN02 016 0003 (2)	
	0.5 - 1.5 mm <sup>2</sup>	20 - 16	100	VN01 016 0002 (2)	VN02 016 0002 (2)	
	1.5 - 2.5 mm <sup>2</sup>	16 - 14	100	VN01 016 0005 (2)	VN02 016 0005 (2)	
<b>Stamped Contacts on reel for hand crimp tools</b>						
silver plating standard	0.14 - 0.5 mm <sup>2</sup>	26 - 20	200	ZN01 016 0003 (1)	ZN02 016 0003 (1)	
	0.5 - 1.5 mm <sup>2</sup>	20 - 16	200	ZN01 016 0002 (1)	ZN02 016 0002 (1)	
	1.5 - 2.5 mm <sup>2</sup>	16 - 14	200	ZN01 016 0005 (1)	ZN02 016 0005 (1)	
silver plating high current	0.5 - 1.5 mm <sup>2</sup>	20 - 16	200	ZN01 016 0015 (1)	ZN02 016 0015 (1)	
	1.5 - 2.5 mm <sup>2</sup>	16 - 14	100	ZN01 016 0016 (1)	ZN02 016 0016 (1)	
gold plating standard	0.14 - 0.5 mm <sup>2</sup>	26 - 20	200	ZN01 016 0003 (2)	ZN02 016 0003 (2)	
	0.5 - 1.5 mm <sup>2</sup>	20 - 16	200	ZN01 016 0002 (2)	ZN02 016 0002 (2)	
	1.5 - 2.5 mm <sup>2</sup>	16 - 14	200	ZN01 016 0005 (2)	ZN02 016 0005 (2)	
<b>Stamped contacts on reel for crimp machines contact feeding left hand side</b>						
silver plating standard	0.14 - 0.5 mm <sup>2</sup>	26 - 20	2000	TN01 016 0003 (1)	TN02 016 0003 (1)	
	0.5 - 1.5 mm <sup>2</sup>	20 - 16	2000	TN01 016 0002 (1)	TN02 016 0002 (1)	
	1.5 - 2.5 mm <sup>2</sup>	16 - 14	2000	TN01 016 0005 (1)	TN02 016 0005 (1)	
silver plating high current	0.5 - 1.5 mm <sup>2</sup>	20 - 16	2000	TN01 016 0015 (1)	TN02 016 0015 (1)	
	1.5 - 2.5 mm <sup>2</sup>	18 - 14	2000	TN01 016 0016 (1)	TN02 016 0016 (1)	
gold plating standard	0.14 - 0.5 mm <sup>2</sup>	26 - 20	2000	TN01 016 0003 (2)	TN02 016 0003 (2)	
	0.5 - 1.5 mm <sup>2</sup>	20 - 16	2000	TN01 016 0002 (2)	TN02 016 0002 (2)	
	1.5 - 2.5 mm <sup>2</sup>	16 - 14	2000	TN01 016 0005 (2)	TN02 016 0005 (2)	
<b>Tools for stamped crimp contacts</b>						
Description	for wire gauge	Part Number				
		Contact locator	Crimping dies	Tool		
Removal tool for contacts	-	-	-	FG 0300 146 1		
Service crimping tool	0.14 - 0.5 mm <sup>2</sup> 0.5 - 1.5 mm <sup>2</sup>	-	-	TA 0100 146		
Crimping tool for single contacts	0.14 - 0.5 mm <sup>2</sup>	TA 0001 146 000 1	TA 0000 202	TA 0000		
	0.5 - 1.5 mm <sup>2</sup>	TA 0002 146 000 1	TA 0000 163	TA 0500		
	1.5 - 2.5 mm <sup>2</sup>	TA 0007 146 000 3	TA 0000 141			
Further tools see catalogue "Tools"						

## heavy|mate® D Turned crimp contacts



Supplied as	for wire gauge	AWG	Pieces	Part Number		Figure
				Male contact	Female contact	
<b>Turned crimp contacts single contact</b>						
silver plating	0.14 - 0.37 mm <sup>2</sup>	26 - 22	100	VN01 016 0024 (1)C	VN02 016 0024 (1)C	
	0.5 mm <sup>2</sup>	20	100	VN01 016 0025 (1)C	VN02 016 0025 (1)C	
	0.75 - 1.0 mm <sup>2</sup>	20 - 16	100	VN01 016 0026 (1)C	VN02 016 0026 (1)C	
	1.5 mm <sup>2</sup>	16 - 15	100	VN01 016 0027 (1)C	VN02 016 0027 (1)C	
	2.5 mm <sup>2</sup>	14	100	VN01 016 0028 (1)C	VN02 016 0028 (1)C	
gold plating	0.14 - 0.37 mm <sup>2</sup>	26 - 22	100	VN01 016 0024 (2)C	VN02 016 0024 (2)C	
	0.5 mm <sup>2</sup>	20	100	VN01 016 0025 (2)C	VN02 016 0025 (2)C	
	0.75 - 1.0 mm <sup>2</sup>	20 - 16	100	VN01 016 0026 (2)C	VN02 016 0026 (2)C	
	1.5 mm <sup>2</sup>	16 - 15	100	VN01 016 0027 (2)C	VN02 016 0027 (2)C	
	2.5 mm <sup>2</sup>	14	100	VN01 016 0028 (2)C	VN02 016 0028 (2)C	
<b>Tools for turned crimp contacts</b>						
Description	for wire gauge	Part Number				
		Contact locator	Crimping dies	Tool		
Removal tool for contacts	-	-	-	FG 0300 146 1		
Service crimping tool	0.14 - 0.5 mm <sup>2</sup> 0.5 - 1.5 mm <sup>2</sup>	-	-	TA 0100 146		
Further tools see catalogue "Tools"						

A high-speed train, silver with orange and black accents, is shown from a front-quarter perspective on a track. The train is moving towards the viewer. Above the train, a complex network of overhead power lines and support structures is visible, extending into the distance. The background consists of green trees and a clear sky. The train's front features a large windshield and two sets of headlights on either side. The tracks are made of steel rails on a gravel bed.

# heavy | mate<sup>®</sup> DD

- Rated voltage 250 V
- Rated current 8 A ... 9 A
- Termination: crimp
- Number of contacts: 24, 42, 72, 108



Approvals, Testhouse	Characteristics	Approval-Number
SEV 	250 V, 10 A	
UL 	600 V, 8,5 A	E 63093
CSA 	600 V, 10 A	LR 700721

In general approvals refer to representative versions of the connector series. Extent and specification of tests upon request.

General Characteristics		Standard	Value			
Number of contacts			24 + ⊕	42 + ⊕	72 + ⊕	108 + ⊕
Termination technique			crimp			
Wire gauge			0.14 mm <sup>2</sup> - 2.5 mm <sup>2</sup>			
Flammability	UL 94		V-0			
Electrical Characteristics						
Rated voltage	IEC 60664-1		250 V (600 V UL / CSA)			
Pollution degree	IEC 60664-1		2 (3 mated and locked)			
Installation (overvoltage) category	IEC 60664-1		III			
Material group	IEC 60664-1		III b			
Rated impulse withstand voltage	IEC 60664-1		4 kV			
Current carrying capacity	IEC 60512-5-2		see derating curves			
Contact resistance	IEC 60512-2-1		≤ 5 m Ω			
Insulation resistance	IEC 60512-3-1		≥ 10 <sup>10</sup> Ω			
Climatical Characteristics						
Climatic category	IEC 60068-1		40 / 100 / 21			
Upper temperature	IEC 60512-11-9		+ 100 °C			
Lower temperature	IEC 60512-11-10		- 40 °C			
Mechanical Characteristics						
Weight pin insert			44 g	50 g	63 g	86 g
IP-degree of protection pin insert	IEC 60529		unmated IP00		mated IP20	
IP-degree of protection socket insert	IEC 60529		unmated IP20		mated IP20	
Weight socket insert			41 g	50 g	67 g	88 g
Mechanical operation	IEC 60512-9-1		> 500 mating cycles			
Materials						
Insert			PBTP			
Colour insert			grey			
Contacts			CuZn (brass)			
Contact plating			Ag (silver)			

Derating curves

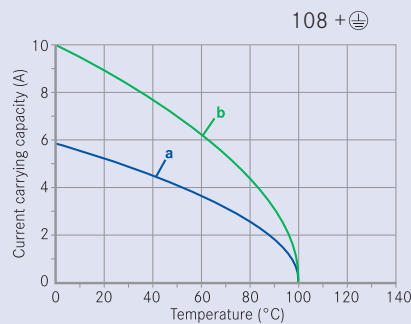
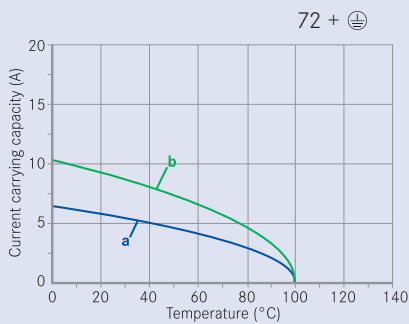
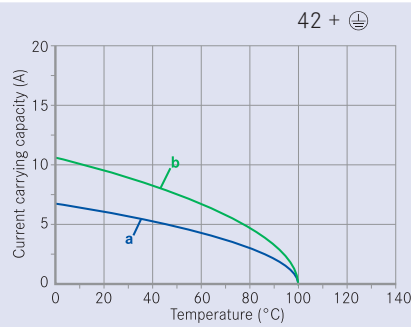
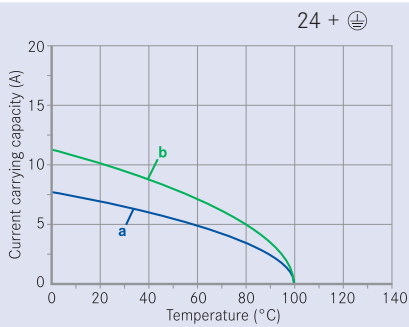



Description	Part Number	Drawing	Figure
<b>Contact insert 24 + ⊕ for turned contacts Size E 6 (Please order contacts separately, see page 43)</b>			
Male insert for turned crimp contacts	C146 10A024 000 9		
Female insert for turned crimp contacts	C146 10B024 000 9		
<b>Contact insert 42 + ⊕ for turned contacts Size E 10 (Please order contacts separately, see page 43)</b>			
Male insert for turned crimp contacts	C146 10A042 000 9		
Female insert for turned crimp contacts	C146 10B042 000 9		
<b>Contact insert 72 + ⊕ for turned contacts Size E 16 (Please order contacts separately, see page 43)</b>			
Male insert for turned crimp contacts	C146 10A072 000 9		
Female insert for turned crimp contacts	C146 10B072 000 9		

**Description**      **Part Number**      **Drawing**      **Figure**

**Contact insert 108 + ⊕ for turned contacts Size E 24 (Please order contacts separately, see page 43)**

Male insert for turned crimp contacts	C146 10A108 000 9		
--	-------------------	--	--

Female insert for turned crimp contacts	C146 10B108 000 9		
--	-------------------	--	--

**Contact insert 216 + ⊕ for turned contacts Size E 48 (Please order contacts separately, see page 43)**

Male insert for turned crimp contacts	C146 10A108 000 9 + C146 10A108 005 9		
--	---	--	--

Female insert for turned crimp contacts	C146 10B108 000 9 + C146 10B108 005 9		
--	---	--	--

**Pin layout**      **Assembly instruction**

<p>Male insert      Female insert</p> <p>X - 4 ( 24 pol. ) 7 ( 42 pol. ) 12 ( 72 pol. ) 18 ( 108 pol. )</p>	<p>Panel cut out (insert)</p> <table border="1"> <thead> <tr> <th>Pol.</th> <th>A</th> <th>B</th> </tr> </thead> <tbody> <tr> <td>24</td> <td>35</td> <td>44</td> </tr> <tr> <td>42</td> <td>48</td> <td>57</td> </tr> <tr> <td>72</td> <td>69</td> <td>77,5</td> </tr> <tr> <td>108</td> <td>95</td> <td>104</td> </tr> </tbody> </table>	Pol.	A	B	24	35	44	42	48	57	72	69	77,5	108	95	104
Pol.	A	B														
24	35	44														
42	48	57														
72	69	77,5														
108	95	104														

## heavy|mate® DD Crimp contacts

Supplied as	for wire gauge	AWG	Pieces	Part Number		Figure
				Male contact	Female contact	
<b>Turned crimp contacts single contact 1.6mm</b>						
silver plating	0.14 - 0,37 mm <sup>2</sup>	26 - 22	100	VN01 016 0024 (1)C	VN02 016 0024 (1)C	
	0.5 mm <sup>2</sup>	20	100	VN01 016 0025 (1)C	VN02 016 0025 (1)C	
	0.75 - 1,0 mm <sup>2</sup>	20 - 16	100	VN01 016 0026 (1)C	VN02 016 0026 (1)C	
	1.5 mm <sup>2</sup>	16 - 15	100	VN01 016 0027 (1)C	VN02 016 0027 (1)C	
	2.5 mm <sup>2</sup>	14	100	VN01 016 0028 (1)C	VN02 016 0028 (1)C	
gold plating	0.14 - 0.37 mm <sup>2</sup>	26 - 22	100	VN01 016 0024 (2)C	VN02 016 0024 (2)C	
	0.5 mm <sup>2</sup>	20	100	VN01 016 0025 (2)C	VN02 016 0025 (2)C	
	0.75 - 1.0 mm <sup>2</sup>	20 - 16	100	VN01 016 0026 (2)C	VN02 016 0026 (2)C	
	1.5 mm <sup>2</sup>	16 - 15	100	VN01 016 0027 (2)C	VN02 016 0027 (2)C	
	2.5 mm <sup>2</sup>	14	100	VN01 016 0028 (2)C	VN02 016 0028 (2)C	
<b>Tools for turned crimp contacts</b>						
Description	for wire gauge	Part Number				
		Contact locator	Crimping dies	Tool		
Removal tool for contacts	-	-	-	FG 0300 146 1		
Service crimping tool	0.14 - 0.5 mm <sup>2</sup> 0.5 - 1.5 mm <sup>2</sup>	-	-	TA 0100 146		
Further tools see catalogue "Tools"						



## heavy | mate<sup>®</sup> E

- Rated voltage 500 V
- Rated current 16 A ... 22 A
- Termination: screw, crimp, tension spring
- Numbers of contacts: 6, 10, 16, 24, 48



Approvals, Testhouse	Characteristics	Approval-Number
SEV	400 V, 16 A	
UL	600 V, 16 A	E 63093
CSA	600 V, 16 A	48932

In general approvals refer to representative versions of the connector series. Extent and specification of tests upon request.

**General information**

- Contact inserts without crimp contacts.
- Connectors series heavy|mate® E may be engaged or disengaged when live but without electrical load. If these connectors are mated or unmated under load, the load shall be reduced to 10 % of the rated current.
- Crimping tools and processing instructions see separate catalogue „Tools“.
- Low and high profile housings are usable.
- If wire ferrule are used, screw terminals without wire protection are preferred.



**No standard for this series, but:**

Interchangeable with other products

- a) contact insert to contact insert 6, 10, 16, 24 contacts
- b) contact insert to housing 6, 10, 16, 24 contacts

Housings are designed according to DIN EN 175 301 - 801

**First-to-mate last-to-break protective ground contact**



**Contact inserts for screw termination, screw termination with wire protection and for crimp termination**



Screw termination



Screw termination with wire protection

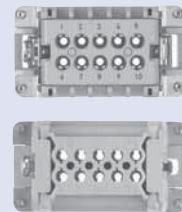

Crimp termination

**Range of housings**

Size E6



Size E10



Size E16



Size E24



Size E48



General Characteristics	Standard	Value				
Number of contacts		6 + ⊖	10 + ⊖	16 + ⊖	24 + ⊖	48 + ⊖
Termination technique		crimp / screw / tension spring				
Wire gauge		0.5 - 4 mm <sup>2</sup>				
Flammability	UL 94	V-0				
Electrical Characteristics						
Rated voltage	IEC 60664-1	max. 500 V (600 V UL / CSA <sup>1)</sup> )				
Pollution degree	IEC 60664-1	3				
Material group	IEC 60664-1	III b				
Installation (overvoltage) category	IEC 60664-1	III				
Rated impulse withstand voltage	IEC 60664-1	6,0 kV				
Current carrying capacity	IEC 60512-5-2	see derating curves				
Rated current T <sub>amp</sub> = 40 °C		22 A	19 A	19 A	18 A	18 A
Contact resistance	IEC 60512-2-1	< 5 mΩ				
Insulation resistance	IEC 60512-3-1	≥ 10 <sup>10</sup> Ω				
Climatical Characteristics						
Climatic category	IEC 60068-1	40 / 125 / 21				
Upper temperature	IEC 60512-11-9	+ 125 °C				
Lower temperature	IEC 60512-11-10	- 40°C				
Mechanical Characteristics						
IP-degree of protection pin insert <sup>2)</sup>	IEC 60529	unmated IP00			mated IP20	
IP-degree of protection socket insert <sup>2)</sup>	IEC 60529	unmated IP20			mated IP20	
Weight:						
male insert crimp (for stamped contacts)		33 g	39 g	45 g	55 g	110 g
female insert crimp (for stamped contacts)		33 g	39 g	49 g	62 g	124 g
male insert screw		43 g	57 g	78 g	105 g	210 g
female insert screw		43 g	57 g	78 g	106 g	212 g
Mechanical operation	IEC 60512-9-1	> 500 mating cycles				
Materials						
Insert		PC GV (Polycarbonat)				
Colour insert		grey				
Screw contacts		CuZn (brass)				
Contact plating		Ag (silver) / Au (gold)				

Description	Part Number	Drawing	Figure
<b>Screw termination</b>			
Male insert for screw termination	C146 10A006 002 1		
Male insert with wire protection for screw termination	C146 10A006 102 1		
Female insert for screw termination	C146 10B006 002 1		
Female insert with wire protection for screw termination	C146 10B006 102 1		
<b>Tension spring</b>			
Male insert with Tension spring	C146 10A006 400 1		
Female insert with Tension spring	C146 10B006 400 1		
<b>Stamped crimp contacts (Please order contacts separately, see page 58)</b>			
Male insert for stamped crimp contacts	C146 10A006 000 1		
Female insert for stamped crimp contacts	C146 10B006 000 1		



Description	Part Number	Drawing	Figure
<b>Turned crimp contacts (Please order contacts separately, see page 58)</b>			
Male insert for turned crimp contacts	C146 10A006 500 1		
Female insert for turned crimp contacts	C146 10B006 500 1		

Pin layout		Assembly instruction	
Male insert	Female insert	Panel cut out (insert)	



Description	Part Number	Drawing	Figure
<b>Screw termination</b>			
Male insert for screw termination	C146 10A010 002 1		
Male insert with wire protection for screw termination	C146 10A010 102 1		
Female insert for screw termination	C146 10B010 002 1		
Female insert with wire protection for screw termination	C146 10B010 102 1		
<b>Tension spring</b>			
Male insert with Tension spring	C146 10A010 400 1		
Female insert with Tension spring	C146 10B010 400 1		
<b>Stamped crimp contacts (Please order contacts separately, see page 58)</b>			
Male insert for stamped crimp contacts	C146 10A010 000 1		
Female insert for stamped crimp contacts	C146 10B010 000 1		

Description	Part Number	Drawing	Figure
<b>Turned crimp contacts (Please order contacts separately, see page 58)</b>			
Male insert for turned crimp contacts	C146 10A010 500 1		
Female insert for turned crimp contacts	C146 10B010 500 1		

Pin layout		Assembly instruction	
Male insert	Female insert	Panel cut out (insert)	

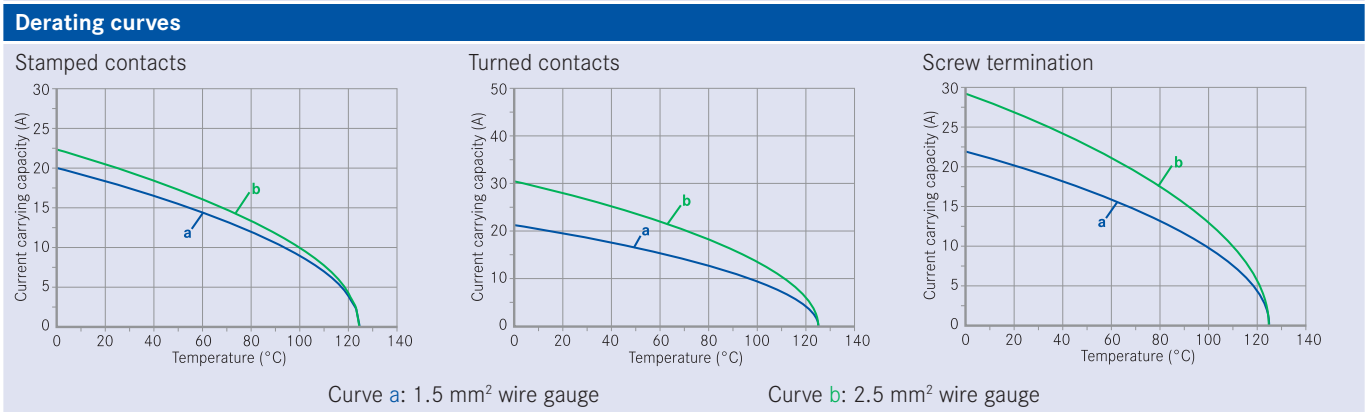

Description	Part Number	Drawing	Figure
<b>Screw termination</b>			
Male insert for screw termination	C146 10A016 002 1		
Male insert with wire protection for screw termination	C146 10A016 102 1		
Female insert for screw termination	C146 10B016 002 1		
Female insert with wire protection for screw termination	C146 10B016 102 1		
<b>Tension spring</b>			
Male insert with Tension spring	C146 10A016 400 1		
Female insert with Tension spring	C146 10B016 400 1		
<b>Stamped crimp contacts (Please order contacts separately, see page 58)</b>			
Male insert for stamped crimp contacts	C146 10A016 000 1		
Female insert for stamped crimp contacts	C146 10B016 000 1		

Description	Part Number	Drawing	Figure
<b>Turned crimp contacts (Please order contacts separately, see page 58)</b>			
Male insert for turned crimp contacts	C146 10A016 500 1		
Female insert for turned crimp contacts	C146 10B016 500 1		

Pin layout		Assembly instruction	
Male insert	Female insert	Panel cut out (insert)	



Description	Part Number	Drawing	Figure
<b>Screw termination</b>			
Male insert for screw termination	C146 10A024 002 1		
Male insert with wire protection for screw termination	C146 10A024 102 1		
Female insert for screw termination	C146 10B024 002 1		
Female insert with wire protection for screw termination	C146 10B024 102 1		
<b>Tension spring</b>			
Male insert with Tension spring	C146 10A024 400 1		
Female insert with Tension spring	C146 10B024 400 1		
<b>Stamped crimp contacts (Please order contacts separately, see page 58)</b>			
Male insert for stamped crimp contacts	C146 10A024 000 1		
Female insert for stamped crimp contacts	C146 10B024 000 1		

**Description** | **Part Number** | **Drawing** | **Figure**

Turned crimp contacts (Please order contacts separately, see page 58)

Male insert  
for turned crimp contacts

C146 10A024 500 1



Female insert  
for turned crimp contacts

C146 10B024 500 1



**Pin layout**

**Assembly instruction**

Male insert

Female insert

Panel cut out (insert)

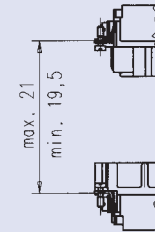
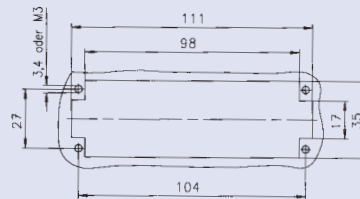

**Derating curves**

Stamped contacts

Turned contacts

Screw termination

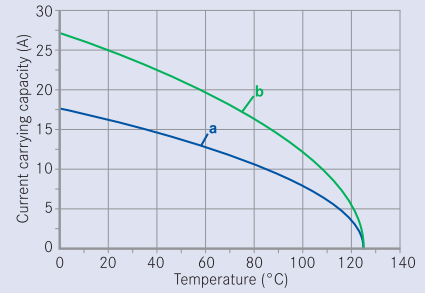
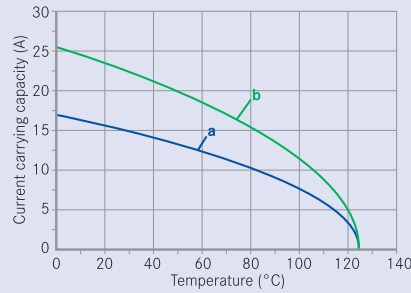
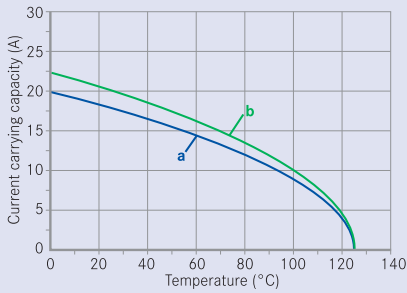

Curve a: 1.5 mm<sup>2</sup> wire gauge

Curve b: 2.5 mm<sup>2</sup> wire gauge

Description	Part Number	Drawing	Figure
<b>Screw termination</b>			
Male insert for screw termination	C146 10A024 002 1 + C146 10A024 002 1		
Male insert with wire protection for screw termination	C146 10A024 102 1 + C146 10A024 102 1		
Female insert for screw termination	C146 10B024 002 1 + C146 10B024 002 1		
Female insert with wire protection for screw termination	C146 10B024 102 1 + C146 10B024 102 1		
<b>Stamped crimp contacts (Please order contacts separately, see page 58)</b>			
Male insert for stamped crimp contacts	C146 10A024 000 1 + C146 10A024 005 1		
Female insert for stamped crimp contacts	C146 10B024 000 1 + C146 10B024 005 1		
<b>Turned crimp contacts (Please order contacts separately, see page 58)</b>			
Male insert for turned crimp contacts	C146 10A024 500 1 + C146 10A024 505 1		
Female insert for turned crimp contacts	C146 10B024 500 1 + C146 10B024 505 1		



Pin layout

Male insert

Female insert



Assembly instruction

Panel cut out (insert)



Derating curves

Stamped contacts



Curve a: 1.5 mm<sup>2</sup> wire gauge

Turned contacts



Curve b: 2.5 mm<sup>2</sup> wire gauge

Screw termination

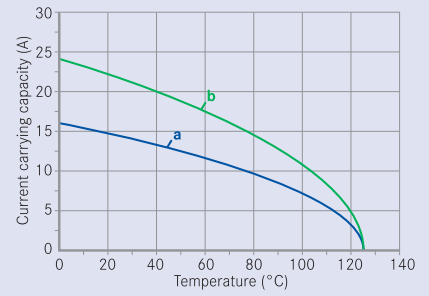

Large range of wire gauges

N01 025 0001 (1)



N01 025 0010 (1)



Gas-tight (coldwelding)

0,5



1,0



1,5



1,5



2,5



Stamped crimp contacts with insulation crimp, to absorb mechanical stress from the crimped connection

Insulation grip

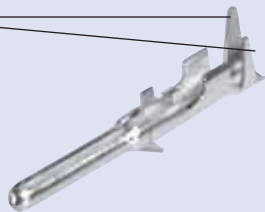

Mechanical retention spring stop on female and male contact

Female contact



Male contact



High current carrying capacity

Example single contact



Curve a: 2.5 mm² wire gauge

Stamped crimp contacts		
<b>Electrical Characteristics</b>		
Contact resistance	IEC 60512-2-1	< 5 m Ω
<b>Mechanical Characteristics</b>		
Mechanical operation	IEC 60512-9-1	≥ 500 mating cycles
<b>Materials</b>		
Male contact		Cu Zn (brass)
Female contact		Cu Sn (tin bronze)
Contact plating		Ag (silver) / Au (gold)
Turned crimp contacts		
<b>Electrical Characteristics</b>		
Contact resistance	IEC 60512-2-1	≤ 5 m Ω
<b>Climatical Characteristics</b>		
Upper temperature	IEC 60512-11-9	+ 125 °C
Lower temperature	IEC 60512-11-10	- 40 °C
<b>Mechanical Characteristics</b>		
Mechanical operation	IEC 60512-9-1	≥ 500 mating cycles
<b>Materials</b>		
Male contact		Cu Zn (brass)
Female contact		Cu Zn (brass)
Contact plating		Ag (silver) / Au (gold)

## heavy|mate® E Stamped crimp contacts

Supplied as	for wire gauge	AWG	Pieces	Part Number		Figure
				Male contact	Female contact	
<b>Stamped single contacts</b>						
silver plating	0.5 - 1.5 mm <sup>2</sup>	20 - 16	100	VN01 025 0001 (101)	VN02 025 0001 (101)	
	1.5 - 2.5 mm <sup>2</sup>	16 - 14	100	VN01 025 0010 (101)	VN02 025 0010 (101)	
gold plating	0.5 - 1.5 mm <sup>2</sup>	20 - 16	100	VN01 025 0001 (102)	VN02 025 0001 (102)	
	1.5 - 2.5 mm <sup>2</sup>	16 - 14	100	VN01 025 0010 (102)	VN02 025 0010 (102)	
<b>Stamped Contacts on reel for hand crimp tools</b>						
silver plating	0.5 - 1.5 mm <sup>2</sup>	20 - 16	200	ZN01 025 0001 (1)	ZN02 025 0001 (1)	
	1.5 - 2.5 mm <sup>2</sup>	16 - 14	100	ZN01 025 0010 (1)	ZN02 025 0010 (1)	
gold plating	0.5 - 1.5 mm <sup>2</sup>	20 - 16	200	ZN01 025 0001 (2)	ZN02 025 0001 (2)	
	1.5 - 2.5 mm <sup>2</sup>	16 - 14	100	ZN01 025 0010 (2)	ZN02 025 0010 (2)	
<b>Stamped contacts on reel for crimp machines contact feeding left hand side</b>						
silver plating	0.5 - 1.5 mm <sup>2</sup>	20 - 16	2000	TN01 025 0001 (1)	TN02 025 0001 (1)	
	1.5 - 2.5 mm <sup>2</sup>	16 - 14	2000	TN01 025 0010 (1)	TN02 025 0010 (1)	
<b>Tools for turned crimp contacts</b>						
Description	for wire gauge	Part Number				
		Contact locator	Crimping dies	Tool		
Removal tool for contacts	-	-	-	FG 0200 146 1		
Crimping tool for stamped single contacts	0.5 - 1.5 mm <sup>2</sup>	TA 0004 146 000 1	TA 0000 163	TA 0000		
	1.5 - 2.5 mm <sup>2</sup>	TA 0005 146 000 3	TA 0000 141			
4-indent crimping tool for turned contacts	0.5 - 4.0 mm <sup>2</sup>	-	-	TB 0600 146		
Further tools see catalogue "Tools"						



## heavy|mate® E Turned crimp contacts

Supplied as	for wire gauge	AWG	Pieces	Part Number		Figure
				Male contact	Female contact	
<b>Turned crimp contacts single contact</b>						
silver plating	0.5 mm <sup>2</sup>	20	100	VN01 025 0035 (1)C	VN02 025 0035 (1)C	
	0.75 - 1.0 mm <sup>2</sup>	18	100	VN01 025 0036 (1)C	VN02 025 0036 (1)C	
	1.5 mm <sup>2</sup>	16	100	VN01 025 0037 (1)C	VN02 025 0037 (1)C	
	2.5 mm <sup>2</sup>	14	100	VN01 025 0038 (1)C	VN02 025 0038 (1)C	
	4.0 mm <sup>2</sup>	12	100	VN01 025 0039 (1)C	VN02 025 0039 (1)C	
gold plating	0.5 mm <sup>2</sup>	20	100	VN01 025 0035 (2)C	VN02 025 0035 (2)C	
	0.75 - 1.0 mm <sup>2</sup>	18	100	VN01 025 0036 (2)C	VN02 025 0036 (2)C	
	1.5 mm <sup>2</sup>	16	100	VN01 025 0037 (2)C	VN02 025 0037 (2)C	
	2.5 mm <sup>2</sup>	14	100	VN01 025 0038 (2)C	VN02 025 0038 (2)C	
	4.0 mm <sup>2</sup>	12	100	VN01 025 0039 (2)C	VN02 025 0039 (2)C	
<b>Tools for turned crimp contacts</b>						
Description	for wire gauge	Part Number				
		Contact locator	Crimping dies	Tool		
Removal tool for contacts				FG 0300 146 7		
Crimping tool for stamped single contacts	0.5 - 2.5 mm <sup>2</sup>	TA 0010 146 000 6	TA 0000 144	TA 0000		
	4 mm <sup>2</sup>	TA 0010 146 000 7	TA 0000 124	TA 0500		
4-indent crimping tool for turned contacts				TB 0600 146		
Further tools see catalogue "Tools"						

# heavy | mate<sup>®</sup> EE

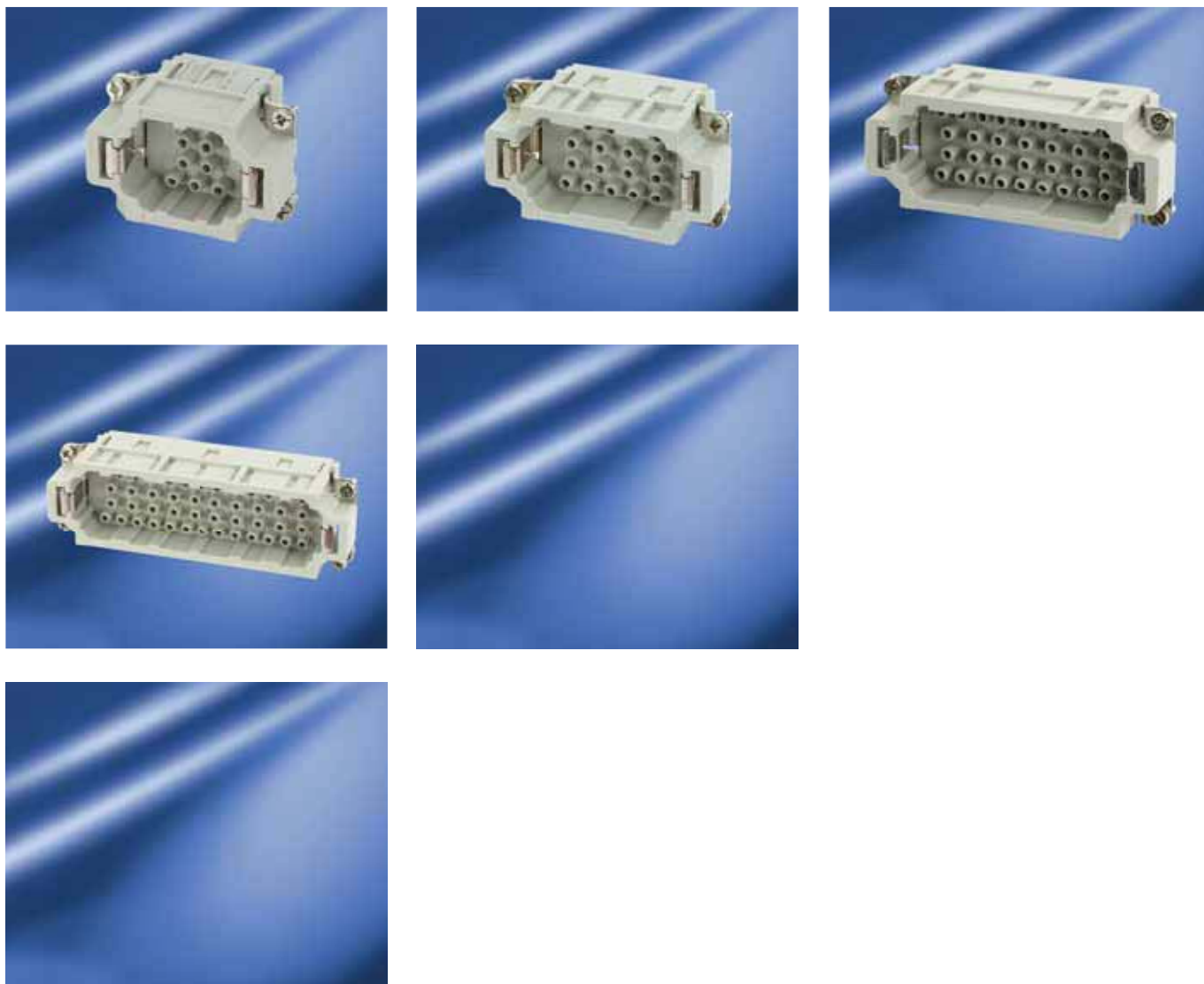
- Rated voltage 500 V (600 V UL / CSA)
- Rated current 16 A
- Termination: crimp
- Numbers of contacts: 10, 18, 32, 46



Approvals, Testhouse	Characteristics	Approval-Number
UL 	600 V, 15 A	E 63093
CSA 	600 V, 16 A	172062-1027396 (LR 48323-2)

In general approvals refer to representative versions of the connector series. Extent and specification of tests upon request.

General Characteristics		Standard	Value			
Number of contacts			10 + ⊕	18 + ⊕	32 + ⊕	46 + ⊕
Termination technique			crimp			
Wire gauge			0.5 mm <sup>2</sup> - 4.0 mm <sup>2</sup>			
Flammability	UL 94		V-0			
Electrical Characteristics						
Rated voltage	IEC 60664-1		500 V (600 V UL / CSA)			
Pollution degree	IEC 60664-1		3			
Installation (overvoltage) category	IEC 60664-1		III			
Material group	IEC 60664-1		III b			
Rated impulse withstand voltage	IEC 60664-1		6 kV			
Current carrying capacity	IEC 60512-5-2		see derating curves			
Contact resistance	IEC 60512-2-1		≤ 5 m Ω			
Insulation resistance	IEC 60512-3-1		≥ 10 <sup>10</sup> Ω			
Climatical Characteristics						
Climatic category	IEC 60068-1		40 / 100 / 21			
Upper temperature	IEC 60512-11-9		+ 100 °C			
Lower temperature	IEC 60512-11-10		- 40 °C			
Mechanical Characteristics						
Mechanical operation	IEC 60512-9-1		> 500 mating cycles			
IP-degree of protection pin insert	IEC 60529		unmated IP00	mated IP20		
IP-degree of protection socket insert	IEC 60529		unmated IP20	mated IP20		
Materials						
Insert			PC			
Colour insert			grey			
Contacts			CuZn (brass)			
Contact plating			Ag (silver) / Au (gold)			

Derating curves





**Description**      **Part Number**      **Drawing**      **Figure**

**Contact insert 10 + ⊕ Size E 6 (Please order contacts separately, see page 67)**

Male insert for turned crimp contacts	C146 10A010 500 10		
Female insert for turned crimp contacts	C146 10B010 500 10		

<b>Pin layout</b>		<b>Assembly instruction</b>	
Male insert 	Female insert 	Panel cut out (insert) 	

**Description**      **Part Number**      **Drawing**      **Figure**

**Contact insert 18 + ⊕ Size E 10 (Please order contacts separately, see page 67)**

Male insert for turned crimp contacts	C146 10A018 500 10		
Female insert for turned crimp contacts	C146 10B018 500 10		

<b>Pin layout</b>		<b>Assembly instruction</b>	
Male insert 	Female insert 	Panel cut out (insert) 	

Description	Part Number	Drawing	Figure
<b>Contact insert 32 + Ⓢ Size E 16 (Please order contacts separately, see page 67)</b>			
Male insert for turned crimp contacts	C146 10A032 500 10		
Female insert for turned crimp contacts	C146 10B032 500 10		

Pin layout	Assembly instruction
<p>Male insert</p> <p>Female insert</p>	<p>Panel cut out (insert)</p>

Description	Part Number	Drawing	Figure
<b>Contact insert 46 + Ⓢ Size E 24 (Please order contacts separately, see page 67)</b>			
Male insert for turned crimp contacts	C146 10A046 500 10		
Female insert for turned crimp contacts	C146 10B046 500 10		

Pin layout	Assembly instruction
<p>Male insert</p> <p>Female insert</p>	<p>Panel cut out (insert)</p>

Supplied as	for wire gauge	AWG	Pieces	Part Number		Figure
				Male contact	Female contact	
<b>Turned crimp contacts single contact 2.5mm</b>						
silver plating	0.5 mm <sup>2</sup>	20	100	VN01 025 0035 (1)C	VN02 025 0035 (1)C	
	0.75 - 1.0 mm <sup>2</sup>	18	100	VN01 025 0036 (1)C	VN02 025 0036 (1)C	
	1.5 mm <sup>2</sup>	16	100	VN01 025 0037 (1)C	VN02 025 0037 (1)C	
	2.5 mm <sup>2</sup>	14	100	VN01 025 0038 (1)C	VN02 025 0038 (1)C	
	4.0 mm <sup>2</sup>	12	100	VN01 025 0039 (1)C	VN02 025 0039 (1)C	
gold plating	0.5 mm <sup>2</sup>	20	100	VN01 025 0035 (2)C	VN02 025 0035 (2)C	
	0.75 - 1.0 mm <sup>2</sup>	18	100	VN01 025 0036 (2)C	VN02 025 0036 (2)C	
	1.5 mm <sup>2</sup>	16	100	VN01 025 0037 (2)C	VN02 025 0037 (2)C	
	2.5 mm <sup>2</sup>	14	100	VN01 025 0038 (2)C	VN02 025 0038 (2)C	
	4.0 mm <sup>2</sup>	12	100	VN01 025 0039 (2)C	VN02 025 0039 (2)C	
<b>Tools for turned crimp contacts</b>						
Description	for wire gauge	Part Number				
		Contact locator	Crimping dies	Tool		
Removal tool for contacts				FG 0300 146 7		
Crimping tool for stamped single contacts	0.5 - 2.5 mm <sup>2</sup>	TA 0010 146 000 6	TA 0000 144	TA 0000		
	4 mm <sup>2</sup>	TA 0010 146 000 7	TA 0000 124	TA 0500		
4-indent crimping tool for turned contacts				TB 0600 146		
Further tools see catalogue "Tools"						

The background image shows a large industrial facility with a high ceiling, steel beams, and several large, teal-colored machines. In the foreground, a white machine with a black control panel and various cables is visible. The machines are arranged in a line, and the floor is concrete with yellow safety markings.

# heavy | mate<sup>®</sup> E / FE / KO

- Rated voltage 400 V
- Material contacts: iron-constantan
- Rated current 10 A
- Number of contacts: 6, 10, 16, 24



**Connectors with iron (FE) and constantan (CO) contacts**

are basically used in measuring and control circuits to serve as interface between FE/CO thermocouples and control unit, i. e. temperature control of moulds in injection moulding machines. Through the use of FE/CO connectors in the thermocouple circuit the measuring results are more accurate, thus the tolerance of the temperature control is much narrower.

Amphenol's Industrial Connectors with iron (FE) and Constantan (CO) contacts are used to connect FE/CO thermocouples with electronic signal amplifiers in measuring and control circuits, i. e. for temperature control of moulding machines.

**Errors with various combinations**

The connection of unlike metals (FE/Brass and CO/Brass) generate thermoelectric voltage errors in the measuring circuit caused by the flow from iron wire to the brass contact or by temperature changes at the contact elements.

Nominal Temp.	Contact Material	without Thermo Contacts		with Thermo Contacts	
		MS/FE	MS/KO	FE/FE	KO/KO
100 °C		+ 4 %	- 16 %	- 4 %	- 2 %
200 °C		+ 2.5 %	- 8 %	- 3 %	- 1.5 %
300 °C		+ 1.3 %	- 12.7 %	- 1.3 %	0 %
400 °C		+ 1.5 %	- 4.5 %	- 1.0 %	0 %

By using FE/CO contacts respectively these deviations will be minimized.

**Material / Temperature Range**

Temperatur range	Material/measurement procedure
< 150 °C	any/Resistance measurement
150 °C - 450 °C	FE-CO (iron/Constantan)
450 °C - approx. 1000 °C	Ni/Cr-Ni (Nickel/Chrome/Nickel)

**Temperature changes cause errors**



## heavy|mate® E / FE / KO Characteristics contact inserts

General Characteristics	Standard	Value			
Number of contacts		6 + $\ominus$	10 + $\ominus$	16 + $\ominus$	24 + $\ominus$
Termination technique		screw			
Wire gauge		0.25 mm <sup>2</sup> - 2.5 mm <sup>2</sup>			
Flammability	UL 94	V-0			
Electrical Characteristics					
Rated voltage	IEC 60664-1	500 V			
Pollution degree	IEC 60664-1	3			
Installation (overvoltage) category	IEC 60664-1	III			
Material group	IEC 60664-1	III b			
Current carrying capacity	IEC 60664-1	6 kV			
Rated current T <sub>amp</sub> = 40 °C		10 A			
Contact resistance	IEC 60512-2-1	≤ 10 mΩ			
Insulation resistance	IEC 60512-3-1	≥ 10 <sup>10</sup> Ω			
Climatical Characteristics					
Climatic category	IEC 60068-1	40 / 100 / 21			
Upper temperature	IEC 60512-11-9	+ 100 °C			
Lower temperature	IEC 60512-11-10	- 40 °C			
Mechanical Characteristics					
IP-degree of protection pin insert <sup>1)</sup>	IEC 60529	unmated IP00		mated IP20	
IP-degree of protection socket insert <sup>1)</sup>	IEC 60529	unmated IP20		mated IP20	
Weight pin insert		45 g	60 g	78 g	105 g
Weight socket insert		45 g	60 g	78 g	105 g
Mechanical operation	IEC 60512-9-1	≥ 100 mating cycles			
Materials					
Insert		PA, GV (Polyamid)			
Colour insert		grey			
Contacts		iron; gal cd 4 constantan = without plating			

Description	Part Number	Drawing	Figure
-------------	-------------	---------	--------

**Contact insert 6 + ⊕ with iron-constantan contacts**

Male insert with wire protection	C146 10A006 810 1		
Female insert with wire protection	C146 10B006 810 1		

**Pin layout**



**Assembly instruction**



Description	Part Number	Drawing	Figure
-------------	-------------	---------	--------

**Contact insert 10 + ⊕ with iron-constantan contacts**

Male insert with wire protection	C146 10A010 810 1		
Female insert with wire protection	C146 10B010 810 1		

**Pin layout**



**Assembly instruction**





Description	Part Number	Drawing	Figure
-------------	-------------	---------	--------

**Contact insert 16 + ⊕ with iron-constantan contacts**

Male insert with wire protection	C146 10A016 810 1		
Female insert with wire protection	C146 10B016 810 1		

**Pin layout**

**Assembly instruction**

Male insert	Female insert	Panel cut out (insert)

Description	Part Number	Drawing	Figure
-------------	-------------	---------	--------

**Contact insert 24 + ⊕ with iron-constantan contacts**

Male insert with wire protection	C146 10A024 810 1		
Female insert with wire protection	C146 10B024 810 1		

**Pin layout**

**Assembly instruction**

Male insert	Female insert	Panel cut out (insert)



# heavy | mate<sup>®</sup> F

- **Modular connector**
- **Compatible with market standard**
- **Rated voltage up to 830 V**
- **Rated current up to 40 A**
- **Termination: crimp**
- **Numbers of contacts: 2 - 102**



Approvals, Testhouse	Characteristics	Approval-Number
UL 	in preparation	in preparation
CSA 	in preparation	in preparation

## General information

- Modules inserts without crimp contacts, crimping tools see separate catalogue “Tools”.
- Contacts must be ordered separately, processing instructions see catalogue “Tools”.
- Connectors series heavy|mate® F may be engaged or disengaged when live but without electrical load.  
If these connectors are mated or unmated under load, the load shall be reduced to 10 % of rated current.

- We recommend using the high profile housings / hoods for the heavy|mate® F inserts.
- Empty modul spaces have to be filled with blind modules.
- Torque for PE connection 1.2 Nm



## Advantages of the system

- No standard but interchangeable with competitive products.
- Housings are designed according to DIN EN 175 301 801
- Simply connecting of the modules and frames.

## First-to-mate last-to-break protective ground contact

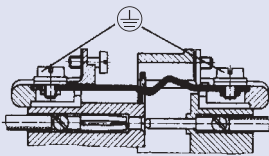

## Range of housings

Size E6



Size E10



Size E16



Size E24



Size E48



### Requirements

- 3 x 400V; 50A; 6mm<sup>2</sup> wire gauge
- 8 x 250V; 8A; 1.5mm<sup>2</sup> wire gauge
- 5 x 400V; 15A; 4mm<sup>2</sup> wire gauge

### Solution

#### 1. Check how 16 contacts can be realized; see modules overview on page 78

Possible selection:

- a) 1 x 17 contacts
- b) 2 x 12 contacts
- c) 1 x 6 contacts + 1 x 12 contacts
- d) 1 x 3 contacts + 1 x 6 contacts + 1 x 12 contacts

#### 2. Check technical parameters / solution, see detail pages of the modules from page 82

Possible selection:

- a) not possible due to voltage
- b) not possible due to voltage
- c) not possible due to current
- d) POSSIBLE

#### 3. Choose matching contact, see detail page of the modules on page 82

Possible selection:

- a) 3 contacts = C146 10A003 500 15 → contacts = VN01 040 0013 1C
- b) 6 contacts = C146 10A006 500 15 → contacts = VN01 025 0039 1C
- c) 12 contacts = C146 10A012 500 15 → contacts = VN01 016 0027 1C

#### 4. Choose matching frame, see frames on page 80

Solution: C146 10P10 000 15

#### 5. Choose matching housing, see housings on page 162

Solution: C146 21R010 600 8

### Schematic construction



Description	Part Number	Drawing	Figure
<b>3 contacts module for turned contacts, details see page 82</b>			
Pin modules	C146 10A003 500 15		
Socket modules	C146 10B003 500 15		
<b>6 contacts module for turned contacts, 500V, details see page 84</b>			
Pin modules	C146 10A006 500 15		
Socket modules	C146 10B006 500 15		
<b>8 contacts module for turned contacts, 400V, details see page 86</b>			
Pin modules	C146 10A008 500 15		
Socket modules	C146 10B008 500 15		

Description	Part Number	Drawing	Figure
<b>12 contacts module for turned contacts. 250V, details see page 88</b>			
Pin modules	C146 10A012 500 15		
Socket modules	C146 10B012 500 15		
<b>17 contacts module for turned contacts, 160V, details see page 90</b>			
Pin modules	C146 10A017 500 15		
Socket modules	C146 10B017 500 15		
<b>20 contacts module for turned contacts 500V, details see page 92</b>			
Pin modules	C146 10A020 500 15		
Socket modules	C146 10B020 500 15		

Description	Part Number	Drawing	Figure
<b>Frames for 2 modules</b>			
Frame for pin modules	C146 10P06 000 15		
Frame for socket modules	C146 10S06 000 15		
<b>Frames for 3 modules</b>			
Frame for pin modules	C146 10P10 000 15		
Frame for socket modules	C146 10S10 000 15		
<b>Frames for 4 modules</b>			
Frame for pin modules	C146 10P16 000 15		
Frame for socket modules	C146 10S16 000 15		



Description	Part Number	Drawing	Figure
<b>Frames for 6 modules</b>			
Frame for pin modules	C146 10P024 000 15		
Frame for socket modules	C146 10S024 000 15		

General Characteristics	Standard	Value
Number of contacts		3
Termination technique		crimp
Wire Gauge		1.5 – 6.0 mm <sup>2</sup> (AWG 16–10)
Flammability	UL94	V-0
Electrical Characteristics		
Rated voltage	IEC 60664-1	400 V (conductor – earth) 690 V (conductor – conductor)
Pollution degree	IEC 60664-1	3
Installation (overvoltage) category	IEC 60664-1	III
Material group	IEC 60664-1	II (PA)
Rated impulse withstand voltage	IEC 60664-1	6 kV
Current carrying capacity	IEC 60512-5-2	see derating curves
Contact resistance	IEC 60512-2-1	≤ 5 mΩ
Insulation resistance	IEC 60512-3-1	≥ 10 <sup>10</sup> Ω
Climatical Characteristics		
Climatic category	IEC 60068-1	40/125/21
Upper temperature	IEC 60512-11-9	+125°C
Lower temperature	IEC 60512-11-10	-40°C
Mechanical Characteristics		
Mechanical operation	IEC 60512-9-1	≥500 mating cycles
IP-degree of protection	IEC 60529	IP00 (pin insert) / IP20 (socket insert)
Materials		
Module		PA6.6 GF
Colour module		black
Contact		CuZn (brass)
Contact plating		Ag (silver) / Au (gold)

**Derating Curves**

In preparation

# heavy|mate® F 3 contacts module + crimp contacts

Description	Part Number	Drawing	Figure
<b>3 contacts module (Please order contacts separately)</b>			
Pin module	C146 10A003 500 15		
Socket module	C146 10B003 500 15		

Supplied as	for wire gauge	AWG	Pieces	Part Number		Figure
				Male contact	Female contact	
<b>Turned 4 mm crimp contacts single contact</b>						
silver plating	1.5 mm <sup>2</sup>	16	100	VN01 040 0010 1C	VN02 040 0010 1C	
	2.5 mm <sup>2</sup>	14	100	VN01 040 0011 1C	VN02 040 0011 1C	
	4 mm <sup>2</sup>	12	100	VN01 040 0012 1C	VN02 040 0012 1C	
	6 mm <sup>2</sup>	10	100	VN01 040 0013 1C	VN02 040 0013 1C	

General Characteristics	Standard	Value
Number of contacts		6
Termination technique		crimp
Wire Gauge		0.5 –4.0 mm <sup>2</sup> (AWG 20-12)
Flammability	UL94	V-0
Electrical Characteristics		
Rated voltage	IEC 60664-1	500 V
Pollution degree	IEC 60664-1	3
Installation (overvoltage) category	IEC 60664-1	III
Material group	IEC 60664-1	II (PA)
Rated impulse withstand voltage	IEC 60664-1	6 kV
Current carrying capacity	IEC 60512-5-2	see derating curves
Contact resistance	IEC 60512-2-1	≤ 5 mΩ
Insulation resistance	IEC 60512-3-1	≥ 10 <sup>10</sup> Ω
Climatical Characteristics		
Climatic category	IEC 60068-1	40/125/21
Upper temperature	IEC 60512-11-9	+125°C
Lower temperature	IEC 60512-11-10	-40°C
Mechanical Characteristics		
Mechanical operation	IEC 60512-9-1	≥500 mating cycles
IP-degree of protection	IEC 60529	IP00 (pin insert) / IP20 (socket insert)
Materials		
Module		PA6.6 GF
Colour module		black
Contact		CuZn (brass)
Contact plating		Ag (silver) / Au (gold)

**Derating Curves**

In preparation

# heavy|mate® F 6 contacts module + crimp contacts

Description	Part Number	Drawing	Figure
<b>6 contacts module (Please order contacts separately)</b>			
Pin module	C146 10A006 500 15		
Socket module	C146 10B006 500 15		

Supplied as	for wire gauge	AWG	Pieces	Part Number		Figure
				Male contact	Female contact	
<b>Turned 2.5 mm crimp contacts single contact</b>						
silver plating	0.5 mm <sup>2</sup>	20	100	VN01 025 0035 (1)C	VN02 025 0035 (1)C	
	0.75 - 1.0 mm <sup>2</sup>	18	100	VN01 025 0036 (1)C	VN02 025 0036 (1)C	
	1.5 mm <sup>2</sup>	16	100	VN01 025 0037 (1)C	VN02 025 0037 (1)C	
	2.5 mm <sup>2</sup>	14	100	VN01 025 0038 (1)C	VN02 025 0038 (1)C	
	4.0 mm <sup>2</sup>	12	100	VN01 025 0039 (1)C	VN02 025 0039 (1)C	
gold plating	0.5 mm <sup>2</sup>	20	100	VN01 025 0035 (2)C	VN02 025 0035 (2)C	
	0.75 - 1.0 mm <sup>2</sup>	18	100	VN01 025 0036 (2)C	VN02 025 0036 (2)C	
	1.5 mm <sup>2</sup>	16	100	VN01 025 0037 (2)C	VN02 025 0037 (2)C	
	2.5 mm <sup>2</sup>	14	100	VN01 025 0038 (2)C	VN02 025 0038 (2)C	
	4.0 mm <sup>2</sup>	12	100	VN01 025 0039 (2)C	VN02 025 0039 (2)C	

## Tools for turned contacts

Description	for wire gauge	Part Number		
		Contact locator	Crimping dies	Tool
Removal tool for contacts				FG 0300 146 7
Crimping tool for turned single contacts	0.5 - 2.5 mm <sup>2</sup> 4 mm <sup>2</sup>	TA 0010 146 000 6 TA 0010 146 000 7	TA 0000 144 TA 0000 124	TA 0000 TA 0500
4-indent crimping tool for turned contacts				TB 0600 146

Further tools see catalogue "Tools"

General Characteristics	Standard	Value
Number of contacts		8
Termination technique		crimp
Wire Gauge		0.5 – 4.0 mm <sup>2</sup> (AWG 20-12)
Flammability	UL94	V-0
Electrical Characteristics		
Rated voltage	IEC 60664-1	400 V
Pollution degree	IEC 60664-1	3
Installation (overvoltage) category	IEC 60664-1	III
Material group	IEC 60664-1	II (PA)
Rated impulse withstand voltage	IEC 60664-1	6 kV
Current carrying capacity	IEC 60512-5-2	see derating curves
Contact resistance	IEC 60512-2-1	≤ 5 mΩ
Insulation resistance	IEC 60512-3-1	≥ 10 <sup>10</sup> Ω
Climatical Characteristics		
Climatic category	IEC 60068-1	40/125/21
Upper temperature	IEC 60512-11-9	+125°C
Lower temperature	IEC 60512-11-10	-40°C
Mechanical Characteristics		
Mechanical operation	IEC 60512-9-1	≥500 mating cycles
IP-degree of protection	IEC 60529	IP00 (pin insert) / IP20 (socket insert)
Materials		
Module		PA6.6 GF
Colour module		black
Contact		CuZn (brass)
Contact plating		Ag (silver) / Au (gold)

**Derating Curves**

In preparation

# heavy|mate® F 8 contacts module + crimp contacts

Description	Part Number	Drawing	Figure
<b>38contacts module (Please order contacts separately)</b>			
Pin module	C146 10A008 500 15		
Socket module	C146 10B008 500 15		

Supplied as	for wire gauge	AWG	Pieces	Part Number		Figure
				Male contact	Female contact	
<b>Turned 2.5 mm crimp contacts single contact</b>						
silver plating	0.5 mm <sup>2</sup>	20	100	VN01 025 0035 (1)C	VN02 025 0035 (1)C	
	0.75 - 1.0 mm <sup>2</sup>	18	100	VN01 025 0036 (1)C	VN02 025 0036 (1)C	
	1.5 mm <sup>2</sup>	16	100	VN01 025 0037 (1)C	VN02 025 0037 (1)C	
	2.5 mm <sup>2</sup>	14	100	VN01 025 0038 (1)C	VN02 025 0038 (1)C	
	4.0 mm <sup>2</sup>	12	100	VN01 025 0039 (1)C	VN02 025 0039 (1)C	
gold plating	0.5 mm <sup>2</sup>	20	100	VN01 025 0035 (2)C	VN02 025 0035 (2)C	
	0.75 - 1.0 mm <sup>2</sup>	18	100	VN01 025 0036 (2)C	VN02 025 0036 (2)C	
	1.5 mm <sup>2</sup>	16	100	VN01 025 0037 (2)C	VN02 025 0037 (2)C	
	2.5 mm <sup>2</sup>	14	100	VN01 025 0038 (2)C	VN02 025 0038 (2)C	
	4.0 mm <sup>2</sup>	12	100	VN01 025 0039 (2)C	VN02 025 0039 (2)C	

## Tools for turned contacts

Description	for wire gauge	Part Number		
		Contact locator	Crimping dies	Tool
Removal tool for contacts				FG 0300 146 7
Crimping tool for turned single contacts	0.5 - 2.5 mm <sup>2</sup> 4 mm <sup>2</sup>	TA 0010 146 000 6 TA 0010 146 000 7	TA 0000 144 TA 0000 124	TA 0000 TA 0500
4-indent crimping tool for turned contacts				TB 0600 146

Further tools see catalogue "Tools"

General Characteristics	Standard	Value
Number of contacts		12
Termination technique		crimp
Wire Gauge		0.14 – 2.5 mm <sup>2</sup> (AWG 26-14)
Flammability	UL94	V-0
Electrical Characteristics		
Rated voltage	IEC 60664-1	250 V (conductor – earth) 400 V (conductor – conductor)
Pollution degree	IEC 60664-1	3
Installation (overvoltage) category	IEC 60664-1	III
Material group	IEC 60664-1	II (PA)
Rated impulse withstand voltage	IEC 60664-1	4 kV
Current carrying capacity	IEC 60512-5-2	see derating curves
Contact resistance	IEC 60512-2-1	≤ 5 mΩ
Insulation resistance	IEC 60512-3-1	≥ 10 <sup>10</sup> Ω
Climatical Characteristics		
Climatic category	IEC 60068-1	40/100/21
Upper temperature	IEC 60512-11-9	+100°C
Lower temperature	IEC 60512-11-10	-40°C
Mechanical Characteristics		
Mechanical operation	IEC 60512-9-1	≥500 mating cycles
IP-degree of protection	IEC 60529	IP00 (pin insert) / IP20 (socket insert)
Materials		
Module		PA6.6 GF
Colour module		black
Contact		CuZn (brass)
Contact plating		Ag (silver) / Au (gold)

**Derating Curves**

In preparation



# heavy|mate® F 12 contacts module + crimp contacts

Description	Part Number	Drawing	Figure
<b>12 contacts module (Please order contacts separately)</b>			
Pin module	C146 10A012 500 15		
Socket module	C146 10B012 500 15		

Supplied as	for wire gauge	AWG	Pieces	Part Number		Figure
				Male contact	Female contact	
<b>Turned crimp contacts single contact</b>						
silver plating	0.14 - 0.37 mm <sup>2</sup>	26 - 22	100	VN01 016 0024 (1)C	VN02 016 0024 (1)C	
	0.5 mm <sup>2</sup>	20	100	VN01 016 0025 (1)C	VN02 016 0025 (1)C	
	0.75 - 1.0 mm <sup>2</sup>	20 - 16	100	VN01 016 0026 (1)C	VN02 016 0026 (1)C	
	1.5 mm <sup>2</sup>	16 - 15	100	VN01 016 0027 (1)C	VN02 016 0027 (1)C	
	2.5 mm <sup>2</sup>	14	100	VN01 016 0028 (1)C	VN02 016 0028 (1)C	
gold plating	0.14 - 0.37 mm <sup>2</sup>	26 - 22	100	VN01 016 0024 (2)C	VN02 016 0024 (2)C	
	0.5 mm <sup>2</sup>	20	100	VN01 016 0025 (2)C	VN02 016 0025 (2)C	
	0.75 - 1.0 mm <sup>2</sup>	20 - 16	100	VN01 016 0026 (2)C	VN02 016 0026 (2)C	
	1.5 mm <sup>2</sup>	16 - 15	100	VN01 016 0027 (2)C	VN02 016 0027 (2)C	
	2.5 mm <sup>2</sup>	14	100	VN01 016 0028 (2)C	VN02 016 0028 (2)C	

## Tools for turned contacts

Description	for wire gauge	Part Number		
		Contact locator	Crimping dies	Tool
Removal tool for contacts	-	-	-	FG 0300 146 1
Service crimping tool	0.14 - 0.5 mm <sup>2</sup> 0.5 - 1.5 mm <sup>2</sup>	-	-	TA 0100 146

Further tools see catalogue "Tools"

General Characteristics	Standard	Value
Number of contacts		17
Termination technique		crimp
Wire Gauge		0.14 - 2.5mm <sup>2</sup> (AWG 26-14)
Flammability	UL94	V-0
Electrical Characteristics		
Rated voltage	IEC 60664-1	160 V
Pollution degree	IEC 60664-1	3
Installation (overvoltage) category	IEC 60664-1	III
Material group	IEC 60664-1	II (PA)
Rated impulse withstand voltage	IEC 60664-1	2.5 kV
Current carrying capacity	IEC 60512-5-2	see derating curves
Contact resistance	IEC 60512-2-1	≤ 5 mΩ
Insulation resistance	IEC 60512-3-1	≥ 10 <sup>10</sup> Ω
Climatical Characteristics		
Climatic category	IEC 60068-1	40/100/21
Upper temperature	IEC 60512-11-9	+100°C
Lower temperature	IEC 60512-11-10	-40°C
Mechanical Characteristics		
Mechanical operation	IEC 60512-9-1	≥500 mating cycles
IP-degree of protection	IEC 60529	IP00 (pin insert) / IP20 (socket insert)
Materials		
Module		PA6.6 GF
Colour module		black
Contact		CuZn (brass)
Contact plating		Ag (silver) / Au (gold)

**Derating Curves**

In preparation

# heavy|mate® F 17 contacts module + crimp contacts

Description	Part Number	Drawing	Figure
<b>17 contacts module (Please order contacts separately)</b>			
Pin module	C146 10A017 500 15		
Socket module	C146 10B017 500 15		

Supplied as	for wire gauge	AWG	Pieces	Part Number		Figure
				Male contact	Female contact	
<b>Turned crimp contacts single contact</b>						
silver plating	0.14 - 0.37 mm <sup>2</sup>	26 - 22	100	VN01 016 0024 (1C)	VN02 016 0024 (1C)	
	0.5 mm <sup>2</sup>	20	100	VN01 016 0025 (1C)	VN02 016 0025 (1C)	
	0.75 - 1.0 mm <sup>2</sup>	20 - 16	100	VN01 016 0026 (1C)	VN02 016 0026 (1C)	
	1.5 mm <sup>2</sup>	16 - 15	100	VN01 016 0027 (1C)	VN02 016 0027 (1C)	
	2.5 mm <sup>2</sup>	14	100	VN01 016 0028 (1C)	VN02 016 0028 (1C)	
gold plating	0.14 - 0.37 mm <sup>2</sup>	26 - 22	100	VN01 016 0024 (2C)	VN02 016 0024 (2C)	
	0.5 mm <sup>2</sup>	20	100	VN01 016 0025 (2C)	VN02 016 0025 (2C)	
	0.75 - 1.0 mm <sup>2</sup>	20 - 16	100	VN01 016 0026 (2C)	VN02 016 0026 (2C)	
	1.5 mm <sup>2</sup>	16 - 15	100	VN01 016 0027 (2C)	VN02 016 0027 (2C)	
	2.5 mm <sup>2</sup>	14	100	VN01 016 0028 (2C)	VN02 016 0028 (2C)	

### Tools for turned contacts

Description	for wire gauge	Part Number		
		Contact locator	Crimping dies	Tool
Removal tool for contacts	-	-	-	FG 0300 146 1
Service crimping tool	0.14 - 0.5 mm <sup>2</sup> 0.5 - 1.5 mm <sup>2</sup>	-	-	TA 0100 146

Further tools see catalogue "Tools"

General Characteristics	Standard	Value
Number of contacts		20
Termination technique		crimp
Wire Gauge		0.5 –4.0 mm <sup>2</sup> (AWG 20-12)
Flammability	UL94	V-0
Electrical Characteristics		
Rated voltage	IEC 60664-1	500 V
Pollution degree	IEC 60664-1	3
Installation (overvoltage) category	IEC 60664-1	III
Material group	IEC 60664-1	II (PA)
Rated impulse withstand voltage	IEC 60664-1	6 kV
Current carrying capacity	IEC 60512-5-2	see derating curves
Contact resistance	IEC 60512-2-1	≤ 5 mΩ
Insulation resistance	IEC 60512-3-1	≥ 10 <sup>10</sup> Ω
Climatical Characteristics		
Climatic category	IEC 60068-1	40/125/21
Upper temperature	IEC 60512-11-9	+125°C
Lower temperature	IEC 60512-11-10	-40°C
Mechanical Characteristics		
Mechanical operation	IEC 60512-9-1	≥500 mating cycles
IP-degree of protection	IEC 60529	IP00 (pin insert) / IP20 (socket insert)
Materials		
Module		PA6.6 GF
Colour module		black
Contact		CuZn (brass)
Contact plating		Ag (silver) / Au (gold)

**Derating Curves**

In preparation

# heavy|mate® F 20 contacts module + crimp contacts

Description	Part Number	Drawing	Figure
<b>20 contacts module (Please order contacts separately)</b>			
Pin module	C146 10A020 500 15		
Socket module	C146 10B020 500 15		

Supplied as	for wire gauge	AWG	Pieces	Part Number		Figure
				Male contact	Female contact	
<b>Turned 2.5 mm crimp contacts single contact</b>						
silver plating	0.5 mm <sup>2</sup>	20	100	VN01 025 0035 (1)C	VN02 025 0035 (1)C	
	0.75 - 1.0 mm <sup>2</sup>	18	100	VN01 025 0036 (1)C	VN02 025 0036 (1)C	
	1.5 mm <sup>2</sup>	16	100	VN01 025 0037 (1)C	VN02 025 0037 (1)C	
	2.5 mm <sup>2</sup>	14	100	VN01 025 0038 (1)C	VN02 025 0038 (1)C	
	4.0 mm <sup>2</sup>	12	100	VN01 025 0039 (1)C	VN02 025 0039 (1)C	
gold plating	0.5 mm <sup>2</sup>	20	100	VN01 025 0035 (2)C	VN02 025 0035 (2)C	
	0.75 - 1.0 mm <sup>2</sup>	18	100	VN01 025 0036 (2)C	VN02 025 0036 (2)C	
	1.5 mm <sup>2</sup>	16	100	VN01 025 0037 (2)C	VN02 025 0037 (2)C	
	2.5 mm <sup>2</sup>	14	100	VN01 025 0038 (2)C	VN02 025 0038 (2)C	
	4.0 mm <sup>2</sup>	12	100	VN01 025 0039 (2)C	VN02 025 0039 (2)C	

### Tools for turned contacts

Description	for wire gauge	Part Number		
		Contact locator	Crimping dies	Tool
Removal tool for contacts				FG 0300 146 7
Crimping tool for turned single contacts	0.5 - 2.5 mm <sup>2</sup>	TA 0010 146 000 6	TA 0000 144	TA 0000
	4 mm <sup>2</sup>	TA 0010 146 000 7	TA 0000 124	TA 0500
4-indent crimping tool for turned contacts				TB 0600 146

Further tools see catalogue "Tools"

The image shows a large industrial testing chamber, likely a high-voltage or high-current test cell, enclosed in a safety cage. The cage is constructed from aluminum frames and clear safety glass. A computer monitor is mounted on the cage, displaying a software interface. The chamber itself is blue and white, with a control panel on the side. The floor is made of perforated metal plates, and there are yellow safety lines on the ground. The ceiling has exposed ductwork and lighting fixtures.

# heavy | mate<sup>®</sup> HSE

- Rated voltage 400 V
- Rated current 42 A
- Termination: screw
- Number of contacts: 6



Approvals, Testhouse	Characteristics	Approval-Number
UL 	600 V, 35 A	48932
CSA 	600 V, 35 A	E 63093

In general approvals refer to representative versions of the connector series. Extent and specification of tests upon request.

General Characteristics	Standard	Value	
Number of contacts		6 + ⊕	
Termination technique		screw	
Wire gauge		0.5 - 6.0 mm <sup>2</sup> (Ø 3.4 mm)	
Flammability	UL 94	V-0	
Electrical Characteristics			
Rated voltage	IEC 60664-1	400 V (600 V UL / CSA <sup>1)</sup> )	
Pollution degree	IEC 60664-1	3	
Installation (overvoltage) category	IEC 60664-1	III	
Material group	IEC 60664-1	II	
Rated impulse withstand voltage	IEC 60664-1	6 kV	
Rated current	IEC 60512-5-2	see derating curves	
Rated current T <sub>amp</sub> = 40 °C		42 A	
Contact resistance	IEC 60512-2-1	≤ 1 m Ω	
Insulation resistance	IEC 60512-3-1	≥ 10 <sup>10</sup> Ω	
Climatical Characteristics			
Climatic category	IEC 60068-1	40 / 125 / 21	
Upper temperature	IEC 60512-11-9	+ 125 °C	
Lower temperature	IEC 60512-11-10	- 40 °C	
Mechanical Characteristics			
IP-degree of protection pin insert	IEC 60529	unmated IP00	mated IP20
IP-degree of protection socket insert	IEC 60529	unmated IP20	mated IP20
Weight pin insert		80 g	
Weight socket insert		80 g	
Mechanical operation	IEC 60512-9-1	≥ 500 mating cycles	
Werkstoffe			
Insert		PA, GV	
Colour insert		black	
Contacts		Cu Zn (brass)	
Contact plating		Ag (silver)	



Description	Part Number	Drawing	Figure
<b>Contact insert 6 + ⊕</b>			
Male insert with wire protection for screw termination	C146 10A006 102 5		
Female insert with wire protection for screw termination	C146 10B006 102 5		

**Pin layout**

Male insert

Female insert

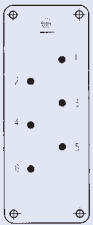

**Assembly instruction**

Panel cut out (insert)



**Derating curves**

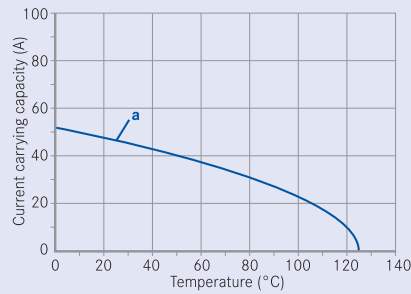



Curve a: 6 mm² screw contact



## heavy | mate<sup>®</sup> HvE

- Rated voltage 660 V
- Rated current 16 A ... 22 A
- Termination: screw
- 2 delayed mating contacts
- Number of contacts: 3, 6, 10, 16, 20, 26, 32



Approvals, Testhouse	Characteristics	Approval-Number
UL 	600 V, 16 A	E 63093
CSA 	600 V, 16 A	48932

In general approvals refer to representative versions of the connector series. Extent and specification of tests upon request.

### Construction of connectors Type HVE

The connectors of series heavy|mate® HVE are based on series heavy|mate® E with the following deviations:

#### Inserts

The HVE-inserts with 3, 6 and 10 contacts are basically the same as the 10, 16 and 24-contacts inserts of series heavy|mate® E. However they are only partly loaded with contacts and have two delayed mating pilot duty contacts.

Only type 16 HVE has special inserts with a different contact arrangement. The mounting dimensions are however identical with the 24 contacts version of heavy|mate® E.

The delayed mating contacts are intended for switching a relay coil for electrically locking in order to have unloaded socket contacts in an unmated condition.

If connectors without breaking capacity are used as connectors with breaking capacity the electrical power data must be reduced in accordance with the manufacturer's specification. These specifications are available from the manufacturer.

heavy|mate® E inserts with pin contacts are not intermatable with heavy|mate® HVE inserts with socket contacts due to

- two empty contact holes are closed at 3, 6 and 10 contact inserts.
- the 16 contacts HVE insert has a different contact arrangement.

#### Housings: (made of aluminium)

heavy|mate® E housings with an inside insulation (plastic foil) are used for the 16-contacts insert.

The inside barriers at the narrow sides preventing mounting of 660 V-inserts in 400 V housings are removed and the 16-contacts insert is now mountable.

#### No standard for this series, but:

Intermatable and exchangeable with other makes

- Contact insert to contact insert
- Contact insert to housing 6, 10, 16, 24 pin

Housings are designed according to DIN EN 175 301-801

#### First-to-mate last-to-break protective ground contact



General Characteristics	Standard	Value						
Number of contacts		3	6	10	16	20	26 <sup>3)</sup>	32
Termination technique		screw						
Wire gauge		0.25 - 2.5 mm <sup>2</sup>						
Flammability	UL 94	V-0						
Electrical Characteristics								
Rated voltage	IEC 60664-1	660 V <sup>1)</sup> (600 V UL / CSA <sup>2)</sup> )						
Pollution degree	IEC 60664-1	3						
Installation (overvoltage) category	IEC 60664-1	III						
Material group	IEC 60664-1	III a	II	IIIa	<sup>3)</sup>	II		
Rated impulse withstand voltage	IEC 60664-1	8 kV						
Current carrying capacity	IEC 60512-5-2	see derating curves						
Contact resistance	IEC 60512-2-1	≤ 5 m Ω						
Insulation resistance	IEC 60512-3-1	≥ 10 <sup>10</sup> Ω						
Climatical Characteristics								
Climatic category	IEC 60068-1	40/125/21						
Upper temperature	IEC 60512-11-9	+ 125°C						
Lower temperature	IEC 60512-11-10	- 40°C						
Mechanical Characteristics								
IP-degree of protection pin insert <sup>4)</sup>	IEC 60529	unmated IP00				mated IP20		
IP-degree of protection socket insert <sup>4)</sup>	IEC 60529	unmated IP20				mated IP20		
Weight pin insert		49 g	63 g	81 g	107 g	162 g	189 g	214 g
Weight socket insert		49 g	63 g	81 g	107 g	162 g	189 g	214 g
Mechanical operation	IEC 60512-9-1	≥ 500 mating cycles						
Materials								
Insert		PC, GV	PA,GV	PC,GV	<sup>3)</sup>	PA,GV		
Colour insert		grey	black	grey	<sup>3)</sup>	black		
Contacts		Cu Zn (brass)						
Contact plating		Ag (silver)						

Description	Part Number	Drawing	Figure
<b>Contact insert 3 + ⊕ + 2 (delayed mating contacts)</b>			
Male insert with wire protection for screw termination	C146 10A003 102 3		
Female insert with wire protection for screw termination	C146 10B003 102 3		

Pin layout		Assembly instruction	
Male insert	Female insert	Panel cut out (insert)	
<ul style="list-style-type: none"> <li>● Working contact</li> <li>◐ Mating contact</li> <li>○ Without contact</li> </ul>			



Description	Part Number	Drawing	Figure
<b>Contact insert 6 + ⊕ + 2 (delayed mating contacts)</b>			
Male insert with wire protection for screw termination	C146 10A006 102 3		
Female insert with wire protection for screw termination	C146 10B006 102 3		

Pin layout		Assembly instruction
Male insert	Female insert	Panel cut out (insert)
<ul style="list-style-type: none"> <li>● Working contact</li> <li>◉ Mating contact</li> <li>○ Without contact</li> </ul>		



Description	Part Number	Drawing	Figure
<b>Contact insert 10 + ⊕ + 2 (delayed mating contacts)</b>			
Male insert with wire protection for screw termination	C146 10A010 102 3		
Female insert with wire protection for screw termination	C146 10B010 102 3		

Pin layout		Assembly instruction	
Male insert	Female insert	Panel cut out (insert)	
	<ul style="list-style-type: none"> <li>● Working contact</li> <li>○ Mating contact</li> <li>○ Without contact</li> </ul>		





Description	Part Number	Drawing	Figure
<b>Contact insert 16 + <math>\oplus</math>2 (delayed mating contacts)</b>			
Male insert with wire protection for screw termination	C146 10A016 102 3		
Male insert without wire protection for screw termination	C146 10A016 002 3		
Female insert with wire protection for screw termination	C146 10B016 102 3		
Female insert without wire protection for screw termination	C146 10B016 002 3		

Pin layout		Assembly instruction	
Male insert	Female insert	Panel cut out (insert)	
	<ul style="list-style-type: none"> <li>● Working contact</li> <li>○ Mating contact</li> <li>○ Without contact</li> </ul>		

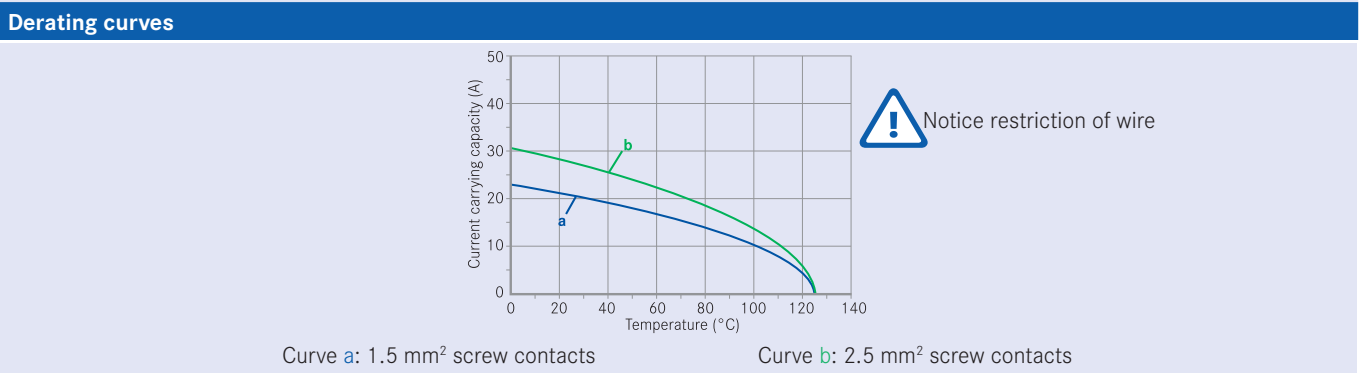









# heavy | mate<sup>®</sup> K

- Power + signal as mixed arrangement
- Rated voltage up to 830 V
- Termination: screw, crimp



Approvals, Testhouse	Characteristics	Approval-Number
UL 	In preparation	In preparation
CSA 	In preparation	In preparation

## heavy|mate® K Characteristics contact inserts 4/0 + 4 / 2

General Characteristics	Standard	Value
Number of contacts		4 / 0 (4 Power) 4 / 2 + PE (4 Power + 2 Signal)
Termination technique		screw
Wire gauge		1.5 – 16 mm <sup>2</sup> (AWG 16-6)
Flammability	UL94	V-0
Electrical Characteristics		
Rated voltage	IEC 60664-1	830 V/400 V
Pollution degree	IEC 60664-1	3
Installation (overvoltage) category	IEC 60664-1	3
Material group	IEC 60664-1	3b
Rated impulse withstand voltage	IEC 60664-1	8.0 kV
Current carrying capacity	IEC 60512-5-2	see derating curves
Contact resistance	IEC 60512-2-1	≤ 5 mΩ
Insulation resistance	IEC 60512-3-1	≥ 10 <sup>10</sup> Ω
Climatical Characteristics		
Climatic category	IEC 60068-1	40/125/21
Upper temperature	IEC 60512-11-9	+125°C
Lower temperature	IEC 60512-11-10	-40°C
Mechanical Characteristics		
Mechanical operation	IEC 60512-9-1	≥500 mating cycles
Materials		
Insert		PC
Colour insert		grey
Contacts		Cu-alloy
Contact plating		Ag (silver)

### Derating Curves

In preparation

Description	Part Number	Drawing	Figure
<b>Contact insert 4/0</b>			
Male insert	C146 10A004 100 13		
Female insert	C146 10B004 100 13		

**Pin layout**

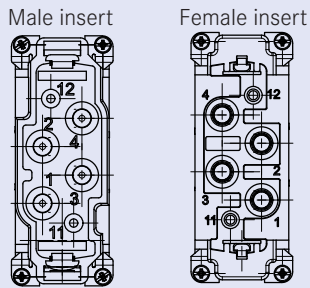

Description	Part Number	Drawing	Figure
<b>Contact insert 4+2+PE</b>			
Male insert	C146 10A006 100 13		
Female insert	C146 10B006 100 13		

**Pin layout**

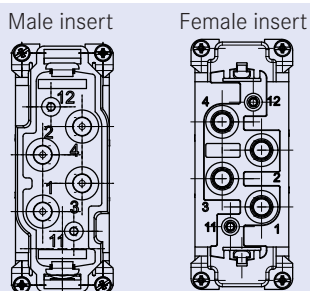

## heavy|mate® K Characteristics contact inserts 6 / 36 + PE

General Characteristics	Standard	Value
Number of contacts		6/36 + PE
Termination technique		crimp
Wire gauge		1.5 – 6.0mm <sup>2</sup> (AWG 16-10) 0.14 – 2.5mm <sup>2</sup> (AWG 26-14)
Flammability	UL94	V-0
Electrical Characteristics		
Rated voltage	IEC 60664-1	690 / 160V
Pollution degree	IEC 60664-1	3
Installation (overvoltage) category	IEC 60664-1	3
Material group	IEC 60664-1	3b
Rated impulse withstand voltage	IEC 60664-1	8.0 / 2.5 kV
Current carrying capacity	IEC 60512-5-2	see derating curves
Contact resistance	IEC 60512-2-1	≤ 5 mΩ
Insulation resistance	IEC 60512-3-1	≥ 10 <sup>10</sup> Ω
Climatical Characteristics		
Climatic category	IEC 60068-1	40 / 125 / 21
Upper temperature	IEC 60512-11-9	125°C
Lower temperature	IEC 60512-11-10	-40°C
Mechanical Characteristics		
Mechanical operation	IEC 60512-9-1	≥500 mating cycles
Materials		
Insert		PC
Colour insert		grey
Contacts		Cu-alloy
Contact plating		Ag (silver) /Au (gold)

### Derating Curves

In preparation



Description	Part Number	Drawing	Figure
<b>Contact insert 6 / 36 + PE (Please order contacts separately)</b>			
Male insert	C146 10A042 500 13		
Female insert	C146 10B042 500 13		

**Pin layout**

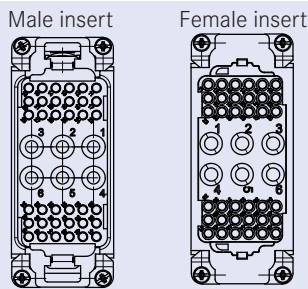





Supplied as	for wire gauge	AWG	Pieces	Part Number		Figure
				Male contact	Female contact	
<b>Turned 4 mm crimp contacts single contact</b>						
silver plating	1.5 mm <sup>2</sup>	16	100	VN01 040 0010 1C	VN02 040 0010 1C	
	2.5 mm <sup>2</sup>	14	100	VN01 040 0011 1C	VN02 040 0011 1C	
	4 mm <sup>2</sup>	12	100	VN01 040 0012 1C	VN02 040 0012 1C	
	6 mm <sup>2</sup>	10	100	VN01 040 0013 1C	VN02 040 0013 1C	
<b>Turned 1.6 mm crimp contacts single contact</b>						
silver plating	0.14 - 0.37 mm <sup>2</sup>	26-22	100	VN01 016 0024 1C	VN02 016 0024 1C	
	0.5 mm <sup>2</sup>	20	100	VN01 016 0025 1C	VN02 016 0025 1C	
	0.75 - 1.0 mm <sup>2</sup>	20-16	100	VN01 016 0026 1C	VN02 016 0026 1C	
	1.5 mm <sup>2</sup>	16-15	100	VN01 016 0027 1C	VN02 016 0027 1C	
	2.5 mm <sup>2</sup>	14	100	VN01 016 0028 1C	VN02 016 0028 1C	



# heavy | mate<sup>®</sup> M

- Modular connector
- More module slots than heavy | mate<sup>®</sup> F and market standard
- Rated voltage 63 - 1000 V
- Rated current 5 A ... 250 A
- Termination: crimp



Approvals, Testhouse	Characteristics	Approval-Number
VDE 	Characteristics see rated voltage and rated current of each module	56 79 ÜG
SEV 		
UL 		E 63093
CSA 		48932

In general approvals refer to representative versions of the connector series. Extent and specification of tests upon request.

## General information

- Modules inserts without crimp contacts, crimping tools see separate catalogue "Tools".
- Contacts must be ordered separately, processing instructions see catalogue "Tools".
- Connectors series heavy|mate® M may be engaged or disengaged when live but without electrical load. If these connectors are mated or unmated under load, the load shall be reduced to 10 % of rated current.

- We recommend using the high profile housings / hoods for the heavy|mate® M inserts.
- Empty modul spaces have to be filled with blind modules.
- Torque for PE connection 1.8 Nm



## Advantages of the system

- High combination possibilities
- Possibility of inverse configuration
- Rated voltage up to 1000 V
- Low cost

## First-to-mate last-to-break protective ground contact

Minimum wire size 0.5 mm<sup>2</sup>



## Modules



## Frames



## Range of housings



### Requirements

- 3 x 400V; 50A; 6mm<sup>2</sup> wire gauge
- 8 x 250V; 8A; 1.5mm<sup>2</sup> wire gauge
- 5 x 400V; 15A; 4mm<sup>2</sup> wire gauge

### Solution

#### 1. Check how 16 contacts can be realized; see modules overview on page 118

Possible selection:

- a) 1 x 20 contacts
- b) 2 x 10 contacts
- c) 1 x 10 contacts+ 1 x 5 contacts
- d) 1 x 3 contacts + 1 x 5 contacts + 1 x 10 contacts

#### 2. Check technical parameters / solution, see detail pages of the modules on page 126

Possible selection:

- a) not possible due to voltage
- b) not possible due to voltage
- c) not possible due to current
- d) POSSIBLE

#### 3. Choose matching contact, see detail page of the modules on page 126

Possible selection:

- a) 3 contacts = C146 A03 001 E8 → contacts = VN01 036 0002 1C
- b) 5 contacts = C146 A05 001 E8 → contacts = VN01 025 0033 1C
- c) 10 contacts = C146 A10 001 E8 → contacts = VN01 016 0027 1XC

#### 4. Choose matching frame, see frames on page 124

Solution: C146 P10 001 G8

#### 5. Choose matching housing, see housings from page 162

Solution: C146 21R010 600 8

### Schematic construction

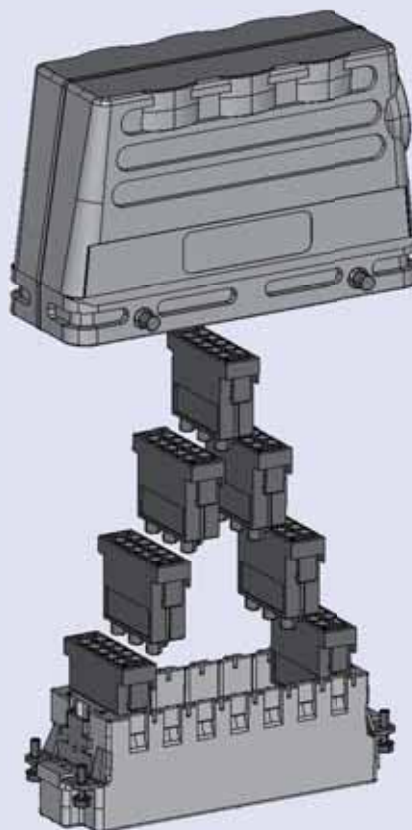

Description	Part Number	Drawing	Figure
<b>1 contact, Details see page 126</b>			
Pin Module	C146 A01 001 E8		
Socket Module	C146 B01 004 E1		
<b>2 contacts for turned contacts, Details see page 128</b>			
Pin Module	C146 A02 001 E8		
Socket Module	C146 B02 001 E8		
<b>2 contacts Powermodule, Details see page 130</b>			
Pin Module	C146 A02 801 E8		
Socket Module	C146 B02 801 E8		

Description	Part Number	Drawing	Figure
<b>3 contacts for turned contacts, 1000 V, Details see page 132</b>			
Pin Module	C146 A03 801 E8		
Socket Module	C146 B03 801 E8		
<b>3 contacts for turned contacts, 690 V, Details see page 134</b>			
Pin Module	C146 A03 001 E8		
Socket Module	C146 B03 001 E8		
<b>5 contacts for stamped contacts, 1000 V, Details see page 136</b>			
Pin Module	C146 D04 001 E8 (4 pol) C146 D05 001 E8 (4 + PE) C146 D05 801 E8 (5 pol)		
Socket Module	C146 C04 001 E8 (4 pol) C146 C05 001 E8 (4 + PE) C146 C05 801 E8 (5 pol)		

Description	Part Number	Drawing	Figure
<b>5 contacts for turned contacts, 400 V, Details see page 138</b>			
Pin Module	C146 A05 001 E8		
Socket Module	C146 B05 001 E8		
<b>10 contacts for stamped contacts, 400 V, Details see page 140</b>			
Pin Module	C146 D10 001 E8		
Socket Module	C146 C10 001 G8		
<b>10 contacts for turned contacts, 400 V, Details see page 142</b>			
Pin Module	C146 A10 001 E8		
Socket Module	C146 B10 001 E8		





Description	Part Number	Drawing	Figure
<b>20 contacts for stamped contacts, 100 V, Details see page 144</b>			
Pin Module	C146 A20 001 G8		
Socket Module	C146 B20 001 G8		
<b>3 contacts for coax contacts, Details see page 146</b>			
Pin Module	C146 A03 501 E8		
Socket Module	C146 B20 001 G8		
<b>RJ module, 400 V, Details see page 148</b>			
Pin Module	C146 E12 001 E8		
Socket Module	C146 F12 001 G8		

Description	Part Number	Drawing	Figure
<b>Pneumatic module, 1 or 2 connections, Details see page 150</b>			
Pin Module	C146 G01 014 G8 (2.5 mm) C146 G01 024 G8 (4.0 mm) C146 G02 014 G8 (2.5 mm) C146 G02 024 G8 (4.0 mm)		
Socket Module	C146 H01 034 G8 (2.5 mm) C146 H01 044 G8 (4.0 mm) C146 H02 034 G8 (2.5 mm) C146 H02 044 G8 (4.0 mm)		
<b>Shielded module 2x4 contacts for bus signals, 50 V, Details see page 152</b>			
Pin Module	C146 A08 102 E8 C146 A05 100 G8		
Socket Module	C146 B08 102 E8 C146 B05 100 G8		

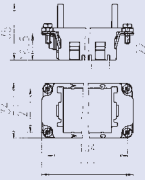

Description	Part Number	Drawing	Figure
<b>Frame for 2 modules   Size 6</b>			
Frame for pin modules	C146 P06 001 G8 C146 P06 002 G8 (2 x PE)		
Frame for socket modules	C146 S06 001 G8 C146 S06 002 G8 (2 x PE)		
<b>Frame for 3 modules   Size 10</b>			
Frame for pin modules	C146 P10 001 G8 C146 P10 002 G8 (2 x PE)		
Frame for socket modules	C146 S10 001 G8 C146 S10 002 G8 (2 x PE)		
<b>Frame for 5 modules   Size 16</b>			
Frame for pin modules	C146 P16 001 G8 C146 P16 002 G8 (2 x PE)		
Frame for socket modules	C146 S16 001 G8 C146 S16 002 G8 (2 x PE)		

Description	Part Number	Drawing	Figure
<b>Frame for 7 modules   Size 24</b>			
Frame for pin modules	C146 P24 001 G8 C146 P24 002 G8 (2 x PE)		
Frame for pin modules	C146 P24 101 G8 C146 P24 102 G8 (2 x PE)		
Frame for socket modules	C146 S24 001 G8 C146 S24 002 G8 (2 x PE)		
Frame for socket modules	C146 S24 101 G8 C146 S24 102 G8 (2 x PE)		

## heavy|mate<sup>®</sup> M Characteristics 1 contact module

General Characteristics	Standard	Value
Number of contacts		1
Termination technique		crimp
Wire gauge		50 / 70 / 95 mm <sup>2</sup> (AWG 1/00/000)
Flammability	UL94	V-0
Electrical Characteristics		
Rated voltage	IEC 60664-1	1000 V
Pollution degree	IEC 60664-1	3
Installation (overvoltage) category	IEC 60664-1	3
Material group	IEC 60664-1	2
Rated impulse withstand voltage	IEC 60664-1	8.0 kV
Current carrying capacity	IEC 60512-5-2	see derating curves
Contact resistance	IEC 60512-2-1	≤ 1 mΩ
Insulation resistance	IEC 60512-3-1	≥ 10 <sup>10</sup> Ω
Climatical Characteristics		
Climatic category	IEC 60068-1	40 / 125 / 21
Upper temperature	IEC 60512-11-9	125°C
Lower temperature	IEC 60512-11-10	-40°C
Mechanical Characteristics		
IP-degree of protection	IEC 60529	20
Mechanical operation	IEC 60512-9-1	≥ 500 mating cycles
Materials		
Module		PA 6.6 GF
Colour module		black
Contacts		Cu-alloy
Contact plating		Ag (silver)

### Derating Curves



Curve	Frame
a	3 Modules
b	1 Modules

# heavy|mate® M 1 contact module + crimp contacts

Description	Part Number	Drawing	Figure
<b>1 contact module (Please order contacts separately)</b>			
Pin module	C146 A01 001 E8		
Socket module	C146 B01 004 E8		

Supplied as	for wire gauge	AWG	Pieces	Part Number		Figure
				Male contact	Female contact	
<b>Turned 10 mm crimp contacts</b>						
Single contact	50 mm <sup>2</sup>	1	1	N01 100 6001 001	N02 100 6121 002	
	70 mm <sup>2</sup>	00	1	N01 100 6002 001	N02 100 6122 002	
	95 mm <sup>2</sup>	000	1	N01 100 6003 001	N02 100 6123 002	

<b>Tools</b>				
Description	for wire gauge	Part Number		
		Contact locator	Crimping dies	Tool
Crimping dies	50 mm <sup>2</sup>		TE 0500 103	
	70 mm <sup>2</sup>		TE 0500 201	
	95 mm <sup>2</sup>		TE 0500 301	

For use in pneumatic crimping tool EK12042 by Klauke or AHPW 400C by Neko .  
Further tools see catalogue "Tools"

## heavy|mate® M Characteristics 2 contacts Radsok module for turned contacts

General Characteristics	Standard	Value
Number of contacts		2
Termination technique		crimp
Wire gauge		16 / 25 / 35 mm <sup>2</sup> (AWG 6/4/2)
Flammability	UL94	V-0
Electrical Characteristics		
Rated voltage	IEC 60664-1	1000 V
Pollution degree	IEC 60664-1	3
Installation (overvoltage) category	IEC 60664-1	3
Material group	IEC 60664-1	2
Rated impulse withstand voltage	IEC 60664-1	8.0 kV
Current carrying capacity	IEC 60512-5-2	see derating curves
Contact resistance	IEC 60512-2-1	≤ 1 mΩ
Insulation resistance	IEC 60512-3-1	≥ 10 <sup>10</sup> Ω
Climatical Characteristics		
Climatic category	IEC 60068-1	40 / 125 / 21
Upper temperature	IEC 60512-11-9	125°C
Lower temperature	IEC 60512-11-10	-40°C
Mechanical Characteristics		
IP-degree of protection	IEC 60529	20
Mechanical operation	IEC 60512-9-1	≥ 500 mating cycles
Materials		
Module		PA 6.6 GF
Colour module		black
Contacts		Cu-alloy
Contact plating		Ag (silver)

### Derating Curves

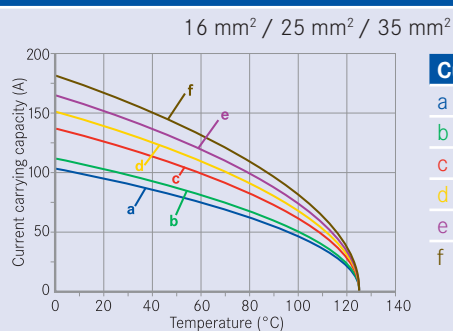



# heavy|mate® M 2 contacts Radsok module + crimp contacts

Description	Part Number	Drawing	Figure
<b>2 contacts module for turned contacts (Please order contacts separately)</b>			
Pin module	C146 A02 001 E8		
Socket module	C146 B02 001 E8		

Supplied as	for wire gauge	AWG	Pieces	Part Number		Figure
				Male contact	Female contact	
<b>Turned 6 mm crimp contacts</b>						
Single contact	16 mm <sup>2</sup>	6	1	N01 060 0007 1	N02 060 6117 001	
	25 mm <sup>2</sup>	4		N01 060 0004 1	N02 060 6114 001	
	35 mm <sup>2</sup>	2		N01 060 0008 1	N02 060 6118 001	
<b>Cable lug for earth connection</b>						
Single contact	16 mm <sup>2</sup>	6	1	N15 043 0003 003		

<b>Tools</b>					
Description	for wire gauge	Part Number			Tool
		Contact locator	Crimping dies		
Crimping dies	16 mm <sup>2</sup>	-	TE 0600 062	-	
	25 mm <sup>2</sup>	-	TE 0600 042	-	
	35 mm <sup>2</sup>	-	TE 0600 022	-	
Further tools see catalogue "Tools"					

General Characteristics	Standard	Value
Number of contacts		2
Termination technique		crimp
Wire gauge		16 mm <sup>2</sup> (AWG 6)
Flammability	UL94	V-0
Electrical Characteristics		
Rated voltage	IEC 60664-1	1000 V
Pollution degree	IEC 60664-1	3
Installation (overvoltage) category	IEC 60664-1	3
Material group	IEC 60664-1	2
Rated impulse withstand voltage	IEC 60664-1	8.0 kV
Current carrying capacity	IEC 60512-5-2	see derating curves
Contact resistance	IEC 60512-2-1	≤ 1 mΩ
Insulation resistance	IEC 60512-3-1	≥ 10 <sup>10</sup> Ω
Climatical Characteristics		
Climatic category	IEC 60068-1	40 / 125 / 21
Upper temperature	IEC 60512-11-9	125 °C
Lower temperature	IEC 60512-11-10	-40 °C
Mechanical Characteristics		
IP-degree of protection	IEC 60512-9-1	≥ 500 Steckzyklen
Mechanical operation	IEC 60529	20
Materials		
Module		PA 6.6 GF
Colour module		black
Contacts		Cu-alloy
Contact plating		Ag (silver)

## Derating Curves

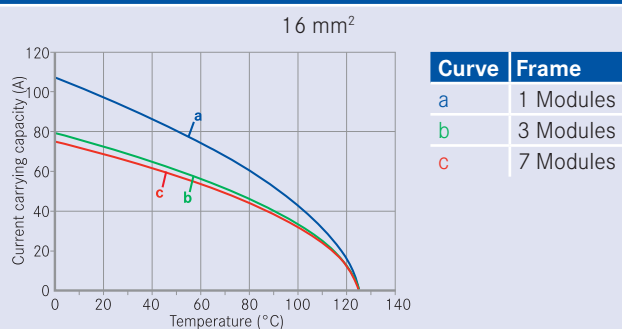

## General requirements

- Due to reduced cross sections at PE contacts of frames, the PE contact has to be additionally protected against short circuits by using a protection circuit offering a sufficiently short breaking time (<0.25s).
- Parts to be used as connectors, not as plug devices (connector with breaking capacity). Do not mate under current or voltage!

# heavy|mate® M 2 contacts Powermodule + crimp contacts

Description	Part Number	Drawing	Figure
<b>2 contacts module (Please order contacts separately)</b>			
Pin module	C146 A02 801 E8		
Socket module	C146 B02 801 E8		

Supplied as	for wire gauge	AWG	Pieces	Part Number		Figure
				Male contact	Female contact	
<b>Turned 3.6 mm crimp contacts</b>						
Single contact	16 mm <sup>2</sup>	6	100	VN01 036 0021 1C	VN02 036 0021 1C	
<b>Cable lug for earth connection</b>						
Single contact	16 mm <sup>2</sup>	6	1	N 15 043 0003 003		

Tools				
Description	for wire gauge	Part Number		
		Contact locator	Crimping dies	Tool
Crimping dies	16 mm <sup>2</sup>	-	-	TE 0600 063 <sup>1)</sup>
Removal tool for contacts		-	-	FG 0300 146 3
Removal tool for modules		-	-	FG 1000 146
Further tools see catalogue "Tools"				

General Characteristics	Standard	Value
Number of contacts		3
Termination technique		crimp
Wire gauge		1.5 - 10 mm <sup>2</sup> (AWG 16 - 8)
Flammability	UL 94	V-0
Electrical Characteristics		
Rated voltage	IEC 60664-1	1000 V <sup>1)</sup>
Pollution degree	IEC 60664-1	3
Installation (overvoltage) category	IEC 60664-1	III
Material group	IEC 60664-1	II
Rated impulse withstand voltage	IEC 60664-1	8.0 kV
Current carrying capacity	IEC 60512-5-2	see derating curves
Contact resistance	IEC 60512-2-1	≤ 1 mΩ
Insulation resistance	IEC 60512-3-1	≥ 10 <sup>10</sup> Ω
Climatical Characteristics		
Climatic category	IEC 60068-1	40 / 125 / 21
Upper temperature	IEC 60512-11-9	+ 125 °C
Lower temperature	IEC 60512-11-10	- 40 °C
Mechanical Characteristics		
IP-degree of protection	IEC 60529	20
Mechanical operation	IEC 60512-9-1	≥ 500 mating cycles
Materials		
Module		PA 6.6 GF
Colour module		black
Contacts		Cu-alloy
Contact plating		Ag (silver)

**Derating Curves**



Curve	Frame
a	7 Modules
b	3 Modules
c	2 Modules
d	1 Modules



Curve	Frame
a	7 Modules
b	3 Modules
c	2 Modules
d	1 Modules



Curve	Frame
a	7 Modules
b	3 Modules
c	1 Modules







Curve	Frame
a	5-7 Modules
b	3 Modules
c	2 Modules
d	1 Modules

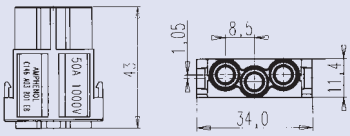

Curve	Frame
a	3-7 Modules
b	2 Modules
c	1 Modules

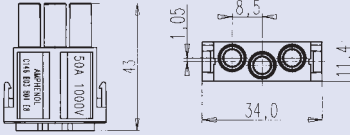
# heavy|mate<sup>®</sup> M 3 contacts module + crimp contacts

Description	Part Number	Drawing	Figure
<b>3 contacts module (Please order contacts separately)</b>			
Pin module	C146 A03 801 E8		
Socket module	C146 B03 801 E8		

Supplied as	for wire gauge	AWG	Pieces	Part Number		Figure
				Male contact	Female contact	
<b>Turned 3.6 mm crimp contacts (All contacts 2mm first-to-mate to other modules)</b>						
	1.5 mm <sup>2</sup>	16	100	VN01 036 0004 (1)C	VN02 036 0004 (1)C	
	2.5 mm <sup>2</sup>	14	100	VN01 036 0005 (1)C	VN02 036 0005 (1)C	
	4.0 mm <sup>2</sup>	12	100	VN01 036 0001 (1)C	VN02 036 0001 (1)C	
	6.0 mm <sup>2</sup>	10	100	VN01 036 0002 (1)C <sup>1)</sup>	VN02 036 0002 (1)C <sup>1)</sup>	
	10.0 mm <sup>2</sup>	8	100	VN01 036 0003 (1)C <sup>1)</sup>	VN02 036 0003 (1)C <sup>1)</sup>	

<b>Tools</b>					
Description	for wire gauge	Part Number			Tool
		Contact locator	Crimping dies		
Removal tool for contacts	-	-	-	-	FG 0300 146 3
Removal tool for modules	-	-	-	-	FG 1000 146
Crimping tool for single contacts	1.5 - 2.5 mm <sup>2</sup>	TA 0010 146 000 2	TA 0000 144	TA 0000	TA 0000
	4.0 mm <sup>2</sup>	TA 0010 146 000 4	TA 0000 124		
	6.0 mm <sup>2</sup>	TA 0010 146 000 4	TA 0000 124		
4-ondet crimping tool <sup>2)</sup>	1.5 -10.0 mm <sup>2</sup>	-	-	-	TB 0200 146
Crimping tool for cable lugs	6.0 mm <sup>2</sup>	-	TA 0000 180	TA 0000	TA 0000
	10.0 mm <sup>2</sup>	-			
<b>Cable lugs for PE connection</b>				<b>Pieces</b>	<b>Part Number</b>
Cable lug	6.0 mm <sup>2</sup>	-	20	N15 006 000 9Z	N15 010 000 7Z
	10.0 mm <sup>2</sup>	-	20		
Further tools see catalogue "Tools"					

General Characteristics	Standard	Value
Number of contacts		3
Termination technique		crimp
Wire gauge		1.5 - 10 mm <sup>2</sup> (AWG 16 - 8)
Flammability	UL 94	V-0
Electrical Characteristics		
Rated voltage	IEC 60664-1	630 V
Pollution degree	IEC 60664-1	3
Installation (overvoltage) category	IEC 60664-1	III
Material group	IEC 60664-1	II (PA)
Rated impulse withstand voltage	IEC 60664-1	8.0 kV
Current carrying capacity	IEC 60512-5-2	see derating curves
Contact resistance	IEC 60512-2-1	≤ 1 mΩ
Insulation resistance	IEC 60512-3-1	≥ 10 <sup>10</sup> Ω
Climatical Characteristics		
Climatic category	IEC 60068-1	40 / 125 / 21
Upper temperature	IEC 60512-11-9	+ 125 °C
Lower temperature	IEC 60512-11-10	- 40 °C
Mechanical Characteristics		
Mechanical operation	IEC 60512-9-1	≥ 500 mating cycles
Materials		
Module		PA 6.6 GF
Colour module		black
Contacts		Cu-alloy
Contact plating		Ag (silver)

**Derating Curves**



Curve	Frame
a	7 Modules
b	3 Modules
c	2 Modules
d	1 Modules



Curve	Frame
a	7 Modules
b	3 Modules
c	2 Modules
d	1 Modules



Curve	Frame
a	7 Modules
b	3 Modules
c	1 Modules



Curve	Frame
a	5-7 Modules
b	3 Modules
c	2 Modules
d	1 Modules



Curve	Frame
a	3-7 Modules
b	2 Modules
c	1 Modules

# heavy|mate® M 3 contacts module + crimp contacts

Description	Part Number	Drawing	Figure
<b>3 contacts module (Please order contacts separately)</b>			
Pin module	C146 A03 001 E8		
Socket module	C146 B03 001 E8		

Supplied as	for wire gauge	AWG	Pieces	Part Number		Figure
				Male contact	Female contact	
<b>Turned 3.6 mm crimp contacts single contact</b>						
silver plating	1.5 mm <sup>2</sup>	16	100	VN01 036 0004 (1)C	VN02 036 0004 (1)C	
	2.5 mm <sup>2</sup>	14	100	VN01 036 0005 (1)C	VN02 036 0005 (1)C	
	4.0 mm <sup>2</sup>	12	100	VN01 036 0001 (1)C	VN02 036 0001 (1)C	
	6.0 mm <sup>2</sup>	10	100	VN01 036 0002 (1)C <sup>1)</sup>	VN02 036 0002 (1)C <sup>1)</sup>	
	10.0 mm <sup>2</sup>	8	100	VN01 036 0003 (1)C <sup>1)</sup>	VN02 036 0003 (1)C <sup>1)</sup>	

<b>Tools</b>					
Description	for wire gauge	Part Number			Tool
		Contact locator	Crimping dies		
Removal tool for contacts	-	-	-	-	FG 0300 146 3
Removal tool for modules	-	-	-	-	FG 1000 146
Crimping tool for single contacts	1.5 - 2.5 mm <sup>2</sup>	TA 0010 146 000 5	TA 0000 144	TA 0000	TA 0000
	4.0 mm <sup>2</sup>	TA 0010 146 000 4	TA 0000 124		
	6.0 mm <sup>2</sup>	TA 0010 146 000 4	TA 0000 124		
4-indent crimping tool <sup>2)</sup>	1.5 -10.0 mm <sup>2</sup>	-	-	-	TB 0200 146
Crimping tool for cable lugs	6.0 mm <sup>2</sup>	-	TA 0000 180	TA 0000	TA 0000
	10.0 mm <sup>2</sup>	-			
<b>Cable lugs for PE connection</b>				<b>Pieces</b>	<b>Part Number</b>
Cable lug	6.0 mm <sup>2</sup>	-	20	N15 006 000 9Z	N15 010 000 7Z
	10.0 mm <sup>2</sup>	-	20		
Further tools see catalogue "Tools"					

# heavy|mate<sup>®</sup> M Characteristics 4 contacts, 4 + ⊕ , 5 contacts module for stamped contacts

General Characteristics	Standard	Value
Number of contacts		4 + ⊕ / 5
Termination technique		crimp
Wire gauge		0.5 - 4.0 mm <sup>2</sup> (AWG 20 - 12)
Flammability	UL 94	V-0
Electrical Characteristics		
Rated voltage	IEC 60664-1	1000 V <sup>1)</sup>
Pollution degree	IEC 60664-1	3
Installation (overvoltage) category	IEC 60664-1	III
Material group	IEC 60664-1	II
Rated impulse withstand voltage	IEC 60664-1	8.0 kV
Current carrying capacity	IEC 60512-5-2	see derating curves
Contact resistance	IEC 60512-2-1	≤ 5 mΩ
Insulation resistance	IEC 60512-3-1	≥ 10 <sup>10</sup> Ω
Climatical Characteristics		
Climatic category	IEC 60068-1	40 / 125 / 21
Upper temperature	IEC 60512-11-9	+ 125 °C
Lower temperature	IEC 60512-11-10	- 40 °C
Mechanical Characteristics		
IP-degree of protection	IEC 60529	20
Mechanical operation	IEC 60512-9-1	≥ 500 mating cycles
Materials		
Module		PA 6.6 GF
Colour module		black
Male contacts		CuZn (brass)
Female contacts		CuSn (bronze)
Contact plating		Ag (silver)

## Derating Curves

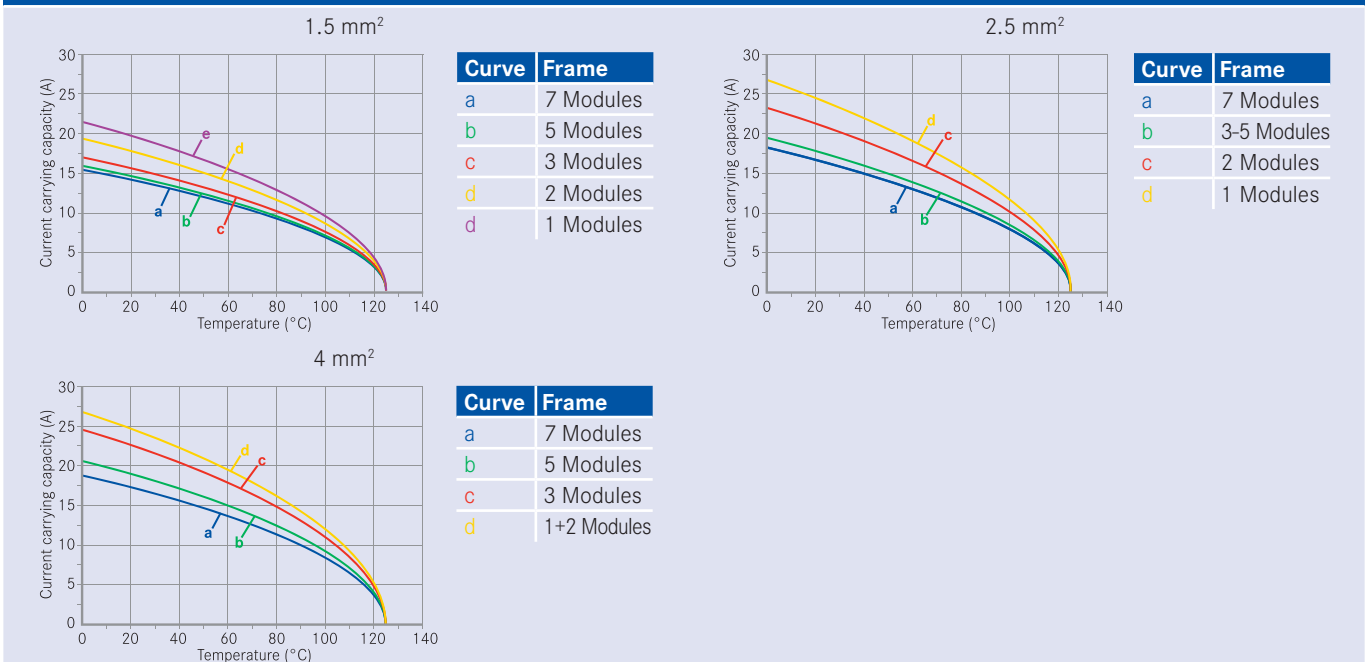



# heavy|mate® M 4 contacts, 4 + PE, 5 contacts module + crimp contacts

Description	Part Number	Drawing	Figure
<b>4 contacts, 4 + PE, 5 contacts module, PE contact 2 mm first-to-mate (Please order contacts separately)</b>			
Pin module	C146 D04 001 E8 (4 pol) C146 D05 001 E8 (4 +PE) C146 D05 801 E8 (5 pol)		
Socket module	C146 C04 001 E8 (4 pol) C146 C05 001 E8 (4 + PE) C146 C05 801 E8 (5 pol)		

Supplied as	for wire gauge	AWG	Pieces	Part Number		Figure
				Male contact	Female contact	

### Stamped single contacts

silver plating	0.5 - 1.5 mm <sup>2</sup>	20 - 16	100	VN01 025 0001 (101)	VN02 025 0001 (101)	
	1.5 - 2.5 mm <sup>2</sup>	16 - 14	100	VN01 025 0010 (101)	VN02 025 0010 (101)	
	2.5 - 4.0 mm <sup>2</sup>	12	100	VN01 025 0043 (1)	VN02 025 0043 (1)	
gold plating	0.5 - 1.5 mm <sup>2</sup>	20 - 16	100	VN01 025 0001 (102)	VN02 025 0001 (102)	
	1.5 - 2.5 mm <sup>2</sup>	16 - 14	100	VN01 025 0010 (102)	VN02 025 0010 (102)	

### Stamped Contacts on reel for hand crimp tools

silver plating	0.5 - 1.5 mm <sup>2</sup>	20 - 16	2000	TN01 025 0001 (1)	TN02 025 0001 (1)	
	1.5 - 2.5 mm <sup>2</sup>	16 - 14	2000	TN01 025 0010 (1)	TN02 025 0010 (1)	
gold plating	0.5 - 1.5 mm <sup>2</sup>	20 - 16	2000	TN01 025 0001 (2)	TN02 025 0001 (2)	
	1.5 - 2.5 mm <sup>2</sup>	16 - 14	2000	TN01 025 0010 (2)	TN02 025 0010 (2)	

### Contacts on reel for crimp machines contact feeding left hand side

silver plating	0.5 - 1.5 mm <sup>2</sup>	20 - 16	2000	TN01 025 0001 (1)	TN02 025 0001 (1)	
	1.5 - 2.5 mm <sup>2</sup>	16 - 14	2000	TN01 025 0010 (1)	TN02 025 0010 (1)	
	2.5 - 4 mm <sup>2</sup>	12	2000	TN01 025 0043 (1)	TN02 025 0043 (1)	

### Tools

Description	for wire gauge	Part Number		
		Contact locator	Crimping dies	Tool
Removal tool for contacts	-	-	-	FG 0200 146 1
Removal tool for modules	-	-	-	FG 1000 146
Crimping tool for single contacts	0.5 - 1.5 mm <sup>2</sup>	TA 0004 146 000 1	TA 0000 163	TA 0000
	1.5 - 2.5 mm <sup>2</sup>	TA 0005 146 000 3	TA 0000 141	
	2.5 - 4.0 mm <sup>2</sup>	TA 0003 146 000 1	TA 0000 121	

Further tools see catalogue "Tools"



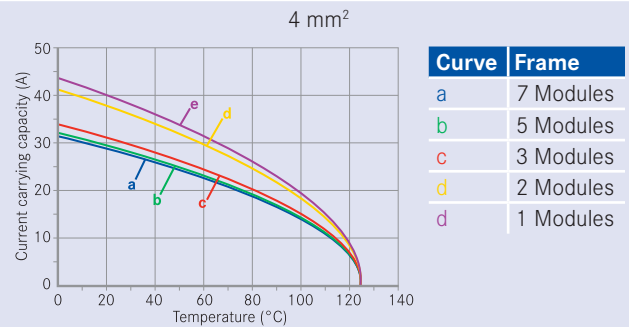

# heavy|mate<sup>®</sup> M Characteristics 5 contacts module for turned contacts

General Characteristics	Standard	Value
Number of contacts		5
Termination technique		crimp
Wire gauge		0.5 - 4.0 mm <sup>2</sup> (AWG 20 - 12)
Flammability	UL 94	V-0
Electrical Characteristics		
Rated voltage	IEC 60664-1	400 V
Pollution degree	IEC 60664-1	3
Installation (overvoltage) category	IEC 60664-1	III
Material group	IEC 60664-1	II
Rated impulse withstand voltage	IEC 60664-1	6.0 kV
Current carrying capacity	IEC 60512-5-2	see derating curves
Contact resistance	IEC 60512-2-1	≤ 2 mΩ
Insulation resistance	IEC 60512-3-1	≥ 10 <sup>10</sup> Ω
Climatical Characteristics		
Climatic category	IEC 60068-1	40 / 125 / 21
Upper temperature	IEC 60512-11-9	+ 125 °C
Lower temperature	IEC 60512-11-10	- 40 °C
Mechanical Characteristics		
Mechanical operation	IEC 60512-9-1	≥ 500 mating cycles
Materials		
Module		PA 6.6 GF
Colour module		black
Contacts		Cu-alloy
Contact plating		Ag (silver)

## Derating Curves

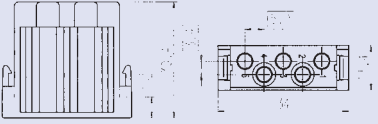

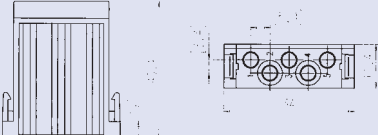
# heavy|mate® M 5 contacts module + crimp contacts

Description	Part Number	Drawing	Figure
<b>5 contacts module (Please order contacts separately)</b>			
Pin module	C146 A05 001 E8		
Socket module	C146 B05 001 E8		

Supplied as	for wire gauge	AWG	Pieces	Part Number		Figure
				Male contact	Female contact	
<b>Turned 2.5 mm crimp contacts single contact</b>						
silver plating	0.5 mm <sup>2</sup>	20	100	VN01 025 0029 (1)C	VN02 025 0029 (1)C	
	0.75 - 1.0 mm <sup>2</sup>	18	100	VN01 025 0030 (1)C	VN02 025 0030 (1)C	
	1.5 mm <sup>2</sup>	16	100	VN01 025 0031 (1)C	VN02 025 0031 (1)C	
	2.5 mm <sup>2</sup>	14	100	VN01 025 0032 (1)C	VN02 025 0032 (1)C	
	4.0 mm <sup>2</sup>	12	100	VN01 025 0033 (1)C	VN02 025 0033 (1)C	

## Tools





Description	for wire gauge	Part Number		
		Contact locator	Crimping dies	Tool
Removal tool for contacts	-	-	-	FG 0300 146 4
Removal tool for modules	-	-	-	FG 1000 146
Crimping tool for single contacts	0.5 - 2.5 mm <sup>2</sup>	TA 0010 146 000 2	TA 0000 144	TA 0000
	4.0 mm <sup>2</sup>	TA 0010 146 000 3	TA 0000 124	
Further tools see catalogue "Tools"				

General Characteristics	Standard	Value
Number of contacts		10
Termination technique		crimp
Wire gauge		0.14 - 2.5 mm <sup>2</sup> (AWG 26 - 14)
Flammability	UL 94	V-0
Electrical Characteristics		
Rated voltage	IEC 60664-1	400 V
Pollution degree	IEC 60664-1	3
Installation (overvoltage) category	IEC 60664-1	III
Material group	IEC 60664-1	II
Rated impulse withstand voltage	IEC 60664-1	6.0 KV
Current carrying capacity	IEC 60512-5-2	see derating curves
Contact resistance	IEC 60512-2-1	≤ 5 mΩ
Insulation resistance	IEC 60512-3-1	≥ 10 <sup>10</sup> Ω
Climatical Characteristics		
Climatic category	IEC 60068-1	40 / 125 / 21
Upper temperature	IEC 60512-11-9	+ 125 °C
Lower temperature	IEC 60512-11-10	- 40 °C
Mechanical Characteristics		
Mechanical operation	IEC 60512-9-1	≥ 500 mating cycles
Materials		
Module		PA 6.6 GF
Colour module		black
Male contacts		CuZn (brass)
Female contacts		CuSn (bronze)
Contact plating		Ag (silver)

**Derating Curves**



# heavy|mate® M 10 contacts module + crimp contacts

Description	Part Number	Drawing	Figure
<b>10 contacts module (Please order contacts separately)</b>			
Pin module	C146 D10 001 E8		
Socket module	C146 C10 001 G8		

Supplied as	for wire gauge	AWG	Pieces	Part Number		Figure
				Male contact	Female contact	

### Stamped 1.6 mm single contact

silver plating	0.14 - 0.5 mm <sup>2</sup>	26 - 20	100	VN01 016 0003 (1)	VN02 016 0003 (1)	
	0.5 - 1.5 mm <sup>2</sup>	20 - 16	100	VN01 016 0002 (1)	VN02 016 0002 (1)	
	1.5 - 2.5 mm <sup>2</sup>	16 - 14	100	VN01 016 0005 (1)	VN02 016 0005 (1)	
gold plating	0.14 - 0.5 mm <sup>2</sup>	26 - 20	100	VN01 016 0003 (2)	VN02 016 0003 (2)	
	0.5 - 1.5 mm <sup>2</sup>	20 - 16	100	VN01 016 0002 (2)	VN02 016 0002 (2)	
	1.5 - 2.5 mm <sup>2</sup>	16 - 14	100	VN01 016 0005 (2)	VN02 016 0005 (2)	

### Stamped Contacts on reel for hand crimp tools

silver plating Standard	0.14 - 0.5 mm <sup>2</sup>	26 - 20	200	ZN01 016 0003 (1)	ZN02 016 0003 (1)	
	0.5 - 1.5 mm <sup>2</sup>	20 - 16	200	ZN01 016 0002 (1)	ZN02 016 0002 (1)	
	1.5 - 2.5 mm <sup>2</sup>	16 - 14	200	ZN01 016 0005 (1)	ZN02 016 0005 (1)	
silver plating High current	0.5 - 1.5 mm <sup>2</sup>	20 - 16	200	ZN01 016 0015 (1)	ZN02 016 0015 (1)	
	1.5 - 2.5 mm <sup>2</sup>	16 - 14	200	ZN01 016 0016 (1)	ZN02 016 0016 (1)	
gold plating Standard	0.14 - 0.5 mm <sup>2</sup>	26 - 20	200	ZN01 016 0003 (2)	ZN02 016 0003 (2)	
	0.5 - 1.5 mm <sup>2</sup>	20 - 16	200	ZN01 016 0002 (2)	ZN02 016 0002 (2)	
	1.5 - 2.5 mm <sup>2</sup>	16 - 14	200	ZN01 016 0005 (2)	ZN02 016 0005 (2)	

### Stamped Contacts on reel for crimp machines contact feeding left hand side

silver plating Standard	0.14 - 0.5 mm <sup>2</sup>	26 - 20	2000	TN01 016 0003 (1)	TN02 016 0003 (1)	
	0.5 - 1.5 mm <sup>2</sup>	20 - 16	2000	TN01 016 0002 (1)	TN02 016 0002 (1)	
	1.5 - 2.5 mm <sup>2</sup>	16 - 14	2000	TN01 016 0005 (1)	TN02 016 0005 (1)	
silver plating High current	0.5 - 1.5 mm <sup>2</sup>	20 - 16	2000	TN01 016 0015 (1)	TN02 016 0015 (1)	
	1.5 - 2.5 mm <sup>2</sup>	18 - 14	2000	TN01 016 0016 (1)	TN02 016 0016 (1)	
gold plating Standard	0.14 - 0.5 mm <sup>2</sup>	26 - 20	2000	TN01 016 0003 (2)	TN02 016 0003 (2)	
	0.5 - 1.5 mm <sup>2</sup>	20 - 16	2000	TN01 016 0002 (2)	TN02 016 0002 (2)	
	1.5 - 2.5 mm <sup>2</sup>	16 - 14	2000	TN01 016 0005 (2)	TN02 016 0005 (2)	

### Tools

Description	for wire gauge	Part Number		
		Contact locator	Crimping dies	Tool
Removal tool for contacts/ modules	-	-	-	FG 0300 146 1 / FG 1000 146
Service crimping tool	0.14 - 0.5 mm <sup>2</sup> 0.5 - 1.5 mm <sup>2</sup>	-	-	TA 0100 146
Crimping tool for single contacts	0.14 - 0.5 mm <sup>2</sup>	TA 0001 146 000 1	TA 0000 202	TA 0000
	0.5 - 1.5 mm <sup>2</sup>	TA 0002 146 000 1	TA 0000 163	
	1.5 - 2.5 mm <sup>2</sup>	TA 0007 146 000 3	TA 0000 141	

Further tools see catalogue "Tools"





# heavy|mate<sup>®</sup> M Characteristics 10 contacts module for turned contacts

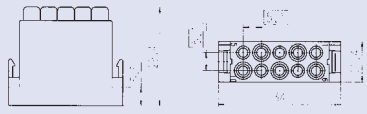

General Characteristics	Standard	Value
Number of contacts		10
Termination technique		crimp
Wire gauge		0.14 - 2.5 mm <sup>2</sup> (AWG 26 - 14)
Flammability	UL 94	V-0
Electrical Characteristics		
Rated voltage	IEC 60664-1	400 V
Pollution degree	IEC 60664-1	3
Installation (overvoltage) category	IEC 60664-1	III
Material group	IEC 60664-1	II (PA)
Rated impulse withstand voltage	IEC 60664-1	6.0 kV
Current carrying capacity	IEC 60512-5-2	siehe Derating Kurven
Contact resistance	IEC 60512-2-1	≤ 5 mΩ
Insulation resistance	IEC 60512-3-1	≥ 10 <sup>10</sup> Ω
Climatical Characteristics		
Climatic category	IEC 60068-1	40 / 100 / 21
Upper temperature	IEC 60512-11-9	+ 100 °C
Lower temperature	IEC 60512-11-10	- 40 °C
Mechanical Characteristics		
Mechanical operation	IEC 60512-9-1	≥ 500 Steckzyklen
Materials		
Module		PA 6.6 GF
Colour module		black
Contacts		CuZn (brass)
Contact plating		Ag (silver)

## Derating Curves

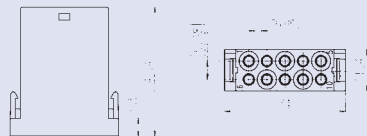

# heavy|mate® M 10 contacts module + crimp contacts

Description	Part Number	Drawing	Figure
<b>10 contacts module (Please order contacts separately)</b>			
Pin module	C146 A10 001 E8		
Socket module	C146 B10 001 E8		

Supplied as	for wire gauge	AWG	Pieces	Part Number		Figure
				Male contact	Female contact	
<b>Turned 1.6 mm crimp contacts single contact</b>						
silver plating	0.14 - 0.37mm <sup>2</sup>	26 - 22	100	VN01 016 0024 (1)C	VN02 016 0024 (1)C	
	0.5 mm <sup>2</sup>	20	100	VN01 016 0025 (1)C	VN02 016 0025 (1)C	
	0.75 - 1.0 mm <sup>2</sup>	20 - 16	100	VN01 016 0026 (1)C	VN02 016 0026 (1)C	
	1.5 mm <sup>2</sup>	16 - 15	100	VN01 016 0027 (1)C	VN02 016 0027 (1)C	
	2.5 mm <sup>2</sup>	14	100	VN01 016 0028 (1)C	VN02 016 0028 (1)C	
gold plating	0.14 - 0.37mm <sup>2</sup>	26 - 22	100	VN01 016 0024 (2)C	VN02 016 0024 (2)C	
	0.5 mm <sup>2</sup>	20	100	VN01 016 0025 (2)C	VN02 016 0025 (2)C	
	0.75 - 1.0 mm <sup>2</sup>	20 - 16	100	VN01 016 0026 (2)C	VN02 016 0026 (2)C	
	1.5 mm <sup>2</sup>	16 - 15	100	VN01 016 0027 (2)C	VN02 016 0027 (2)C	
	2.5 mm <sup>2</sup>	14	100	VN01 016 0028 (2)C	VN02 016 0028 (2)C	
<b>FO contacts</b>						
single contact	1.0 mm POF	-	10	VN01 016 0040 (8) X	VN02 016 0040 (8) X	

Tools					
Description	for wire gauge	Part Number			Tool
		Contact locator	Crimping dies		
Removal tool for contacts	-	-	-	-	FG 0300 146 1
Removal tool for modules	-	-	-	-	FG 1000 146
Crimping tool for single contacts	0.14 - 1.0 mm <sup>2</sup> 1.5 mm <sup>2</sup> 2.5 mm <sup>2</sup>	TA 0010 146 000 1	TA 0000 184		TA 0000
Crimpzange für LWL Kontakte <sup>1)</sup>	1.0 mm POF/FO	-	-	-	TB 0500 146
Further tools see catalogue "Tools"					

General Characteristics	Standard	Value
Number of contacts		20
Termination technique		crimp
Wire gauge		0.09 - 0.5 mm <sup>2</sup> (AWG 28 - 20)
Flammability	UL 94	V-0
Electrical Characteristics		
Rated voltage	IEC 60664-1	63 V
Pollution degree	IEC 60664-1	3
Installation (overvoltage) category	IEC 60664-1	III
Material group	IEC 60664-1	II (PA)
Rated impulse withstand voltage	IEC 60664-1	4.0 KV
Current carrying capacity	IEC 60512-5-2	see derating curves
Contact resistance	IEC 60512-2-1	≤ 5 mΩ
Insulation resistance	IEC 60512-3-1	≥ 10 <sup>10</sup> Ω
Climatical Characteristics		
Climatic category	IEC 60068-1	40 / 125 / 21
Upper temperature	IEC 60512-11-9	+ 125 °C
Lower temperature	IEC 60512-11-10	- 40 °C
Mechanical Characteristics		
Mechanical operation	IEC 60512-9-1	≥ 500 mating cycles
Materials		
Module		PA 6.6 GF
Colour module		black
Male contacts		CuZn (brass)
Female contacts		CuSn (bronze)
Contact plating		Au (gold)

**Derating-Kurven**

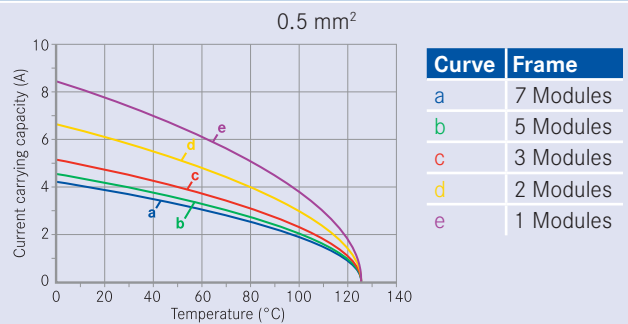
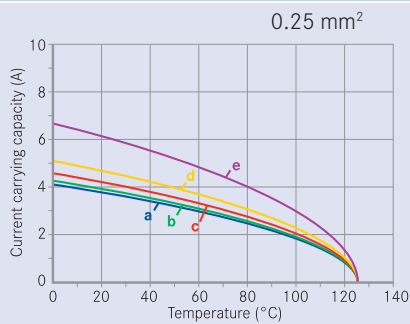





## heavy|mate<sup>®</sup> M Characteristics 3 contacts module for coax contacts

General Characteristics	Standard	Value
Number of contacts		3
Termination technique		crimp, solder
Flammability	UL 94	V-0
Electrical Characteristics		
Rated voltage	IEC 60664-1	250 V
Pollution degree	IEC 60664-1	3
Installation (overvoltage) category	IEC 60664-1	III
Material group	IEC 60664-1	II
Impedance		50 Ω
Working frequency		2 GHz
Climatical Characteristics		
Climatic category	IEC 60068-1	40 / 125 / 21
Upper temperature	IEC 60512-11-9	+ 125 °C
Lower temperature	IEC 60512-11-10	- 40 °C
Mechanical Characteristics		
Mechanical operation	IEC 60512-9-1	≥ 500 mating cycles
Materials		
Module		PA 6.6 GF
Colour module		redbrown
Contact plating		Au (gold)

### Contact dimensions

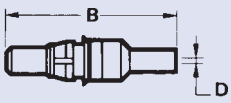
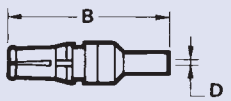
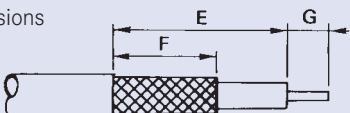
	Part Number	B	D	E	F	G
Male contact 	17 DM 537 401	23.6	1.7	7.9	6.3	2
Female contact 	17 DM 537 421	23.6	1.7	7.9	6.3	2
	17 DM 537 405	26.3	3.2	9.5	7.9	2
Stripping dimensions 	17 DM 537 425	26.3	3.2	9.5	7.9	2

# heavy|mate® M 3 contacts module for coax contacts + crimp contacts

Description	Part Number	Drawing	Figure
<b>3 contacts module for coax contacts (Please order contacts separately)</b>			
Pin module	C146 A03 501 E8		
Socket module	C146 B03 501 E8		

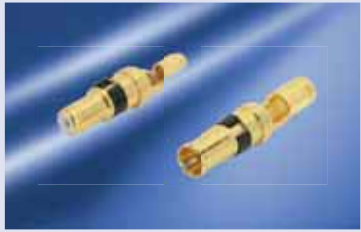
Supplied as	for wire gauge	AWG	Pieces	Part Number		Figure
				Male contact	Female contact	
<b>Single contacts <sup>1)</sup></b>						
	RG 174, 179, 316		1	17 DM 537 401	17 DM 537 421	
	RG 58		1	17 DM 537 405	17 DM 537 425	

<b>Tools</b>						
Description	for cable size	6-hex-size in mm			Part Number	
					Crimping dies	Tool
Removal tool for contacts	-	-	-	-	-	FG 0300 146 3
Removal tool for modules	-	-	-	-	-	FG 1000 146
Crimping tool for single contacts	RG 58	5.4	(6.5)	(1.7)	TA 0000 401	TA 0000
	RG 174, 179, 316	3.25	(4.5)	(1.7)	TA 0000 402	TA 0000
Further tools see catalogue "Tools"						

## Brief information

- For integration of standard RJ45 components
- Worldwide real-time access on machines and facilities
- Easy assembly through the use of standard RJ45 components
- One connector for power, signal and data transmission
- 4 additional power crimp contacts
- Time- and money saving through the use of similar active- and passive components
- Unitary transmission protocol in the office- and production environment.
- Meets CAT 5 for Ethernet acc. ISO/IEC 11801

General Characteristics	Standard	Value module	Value RJ45
Number of contacts		4	8
Termination technique		crimp	mate
Wire gauge		0.14 - 2.5mm <sup>2</sup>	
Flammability	UL 94	V-0	V - 0
Electrical Characteristics			
Rated voltage	IEC 60664-1	400 V AC	125 V AC
Rated impulse withstand voltage	IEC 60664-1	6 kV	1.8 kV
Current carrying capacity	IEC 60512-5-2	13 A <sup>1)</sup>	1.5 A
Contact resistance	IEC 60512-2-1	≤ 5 mΩ	≤ 20 mΩ
Insulation resistance	IEC 60512-3-1	10 <sup>10</sup> Ω	5 <sup>8</sup> Ω
Climatical Characteristics			
Upper temperature	IEC 60512-11-9	+ 100 °C	+ 80 °C
Lower temperature	IEC 60512-11-10		- 20 °C
Mechanical Characteristics			
Mechanical operation	IEC 60512-9-1	≥ 500 mating cycles	≥ 500 mating cycles
Materials			
Module		PA 6.6 GF	
Colour module		black	black
Male contacts		CuZn (brass)	CuSn (bronze)
Female contacts		CuZn (brass)	CuSn (bronze)
Contact plating		Ag (silver)	Au (gold)

# heavy|mate® M RJ module + crimp contacts

Description	Part Number	Drawing	Figure
<b>RJ module</b>			
Pin module	C146 E12 001 E8		
Socket module	C146 F12 001 G8		

Supplied as	for wire gauge	AWG	Pieces	Part Number		Figure
				Male contact	Female contact	
<b>Turned 1.6 mm single contacts</b>						
silver plating	0.14 - 0.37 mm <sup>2</sup>	26 - 22	100	VN01 016 0024 (1)C	VN02 016 0024 (1)C	
	0.5 mm <sup>2</sup>	20	100	VN01 016 0025 (1)C	VN02 016 0025 (1)C	
	0.75 - 1.0 mm <sup>2</sup>	20 - 16	100	VN01 016 0026 (1)C	VN02 016 0026 (1)C	
	1.5 mm <sup>2</sup>	16 - 15	100	VN01 016 0027 (1)C	VN02 016 0027 (1)C	
	2.5 mm <sup>2</sup>	14	100	VN01 016 0028 (1)C	VN02 016 0028 (1)C	
gold plating	0.14 - 0.37 mm <sup>2</sup>	26 - 22	100	VN01 016 0024 (2)C	VN02 016 0024 (2)C	
	0.5 mm <sup>2</sup>	20	100	VN01 016 0025 (2)C	VN02 016 0025 (2)C	
	0.75 - 1.0 mm <sup>2</sup>	20 - 16	100	VN01 016 0026 (2)C	VN02 016 0026 (2)C	
	1.5 mm <sup>2</sup>	16 - 15	100	VN01 016 0027 (2)C	VN02 016 0027 (2)C	
	2.5 mm <sup>2</sup>	14	100	VN01 016 0028 (2)C	VN02 016 0028 (2)C	

**Brief information**

- Power, signal and pneumatic within a single connector
- Very stable brass contacts
- Pneumatic socket contacts with barrier, closes when the connector is open
- Available with single or double connections
- Connection for 2.5 mm or 4 mm PTFE (Teflon)-tubes
- Tubes can be disassembled from the terminations

General Characteristics	Standard	Value
Number of contacts		1 / 2
Termination technique		tube termination
Wire gauge		2.5 mm / 4.0 mm
Flammability	UL 94	V-0
Technical Characteristics		
Operating pressure		8 bar with PTFE tube
Operating path		4.0 mm
Locking		locking on one side
Pneumatic tube		only use PTFE tubes <sup>1)</sup>
Climatical Characteristics		
Upper temperature		+100 °C
Lower temperature		- 20 °C
Mechanical Characteristics		
Mechanical operation		5000 mating cycles
Materials		
Module		PA 6.6 GF
Colour module		black
Contacts		Brass MS 58







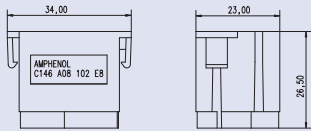

Description	Part Number	Drawing	Figure
<b>Pneumatic module</b>			
Pin module	C146 G01 014 G8 (2.5 mm) C146 G01 024 G8 (4.0 mm)		
Socket module	C146 H01 034 G8 (2.5 mm) C146 H01 044 G8 (4.0 mm)		
Pin module	C146 G02 014 G8 (2.5 mm) C146 G02 024 G8 (4.0 mm)		
Socket module	C146 H02 034 G8 (2.5 mm) C146 H02 044 G8 (4.0 mm)		

## heavy|mate<sup>®</sup> M Characteristics Shielded module

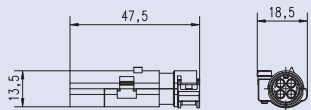
General Characteristics	Standard	Value
Number of contacts		2X4
Termination technique		crimp
Wire gauge		0.14 – 2.5 mm <sup>2</sup> (AWG 26-14)
Flammability	UL94	V-0
Electrical Characteristics		
Rated voltage	IEC 60664-1	50V
Pollution degree	IEC 60664-1	3
Installation (overvoltage) category	IEC 60664-1	3
Material group	IEC 60664-1	3b
Rated impulse withstand voltage	IEC 60664-1	0.8 kV
Current carrying capacity	IEC 60512-5-2	10A
Contact resistance	IEC 60512-2-1	≤ 5mΩ
Climatical Characteristics		
Climatic category	IEC 60068-1	40 / 125 / 21
Upper temperature	IEC 60512-11-9	125°C
Lower temperature	IEC 60512-11-10	-40°C
Mechanical Characteristics		
Mechanical operation	IEC 60512-9-1	≥ 500 mating cycles
Materials		
Module		PC
Colour module		grey
Contacts		Cu-alloy
Contact plating		Au (gold)

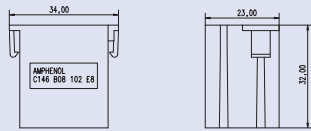

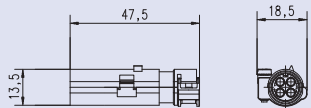
# heavy|mate® M Shielded module + crimp contacts

Description	Part Number	Drawing	Figure
<b>Contact insert 2x4 contacts (Please order contacts separately)</b>			
Pin module	C146 A08 102 E8		
Male contact carriers 4 contacts	C146 A05 100 G8		
Socket module	C146 B08 102 E8		
Female contact carriers 4 contacts	C146 B05 100 G8		

Supplied as	for wire gauge	AWG	Pieces	Part Number		Figure
				Male contact	Female contact	
<b>Turned 1.6mm crimp contacts</b>						
Single contacts	0.14 – 0.37 mm <sup>2</sup>	26-22	100	VN01 016 0024 2C	VN02 016 0024 2C	
	0.5 mm <sup>2</sup>	20	100	VN01 016 0025 2C	VN02 016 0025 2C	
	0.75 – 1.0 mm <sup>2</sup>	20-16	100	VN01 016 0026 2C	VN02 016 0026 2C	
	1.5 mm <sup>2</sup>	16-15	100	VN01 016 0027 2C	VN02 016 0027 2C	
	2.5 mm <sup>2</sup>	14	100	VN01 016 0028 2C	VN02 016 0028 2C	

<b>Tools</b>				
Description	for wire gauge	Part Number		
		Contact locator	Crimping dies	Tool
Crimping tool	-	-	-	TA 0000 oder TA 0500
Crimping dies	-	-	-	TA 00000 184
Contact locator	-	-	-	TA 0010 146 000 1
Removal tool for contacts	-	-	-	FG 0300 146 1

Further tools see catalogue "Tools"

Contact size	Part Number	Figure
1.0 mm	17D 438 SP	
1.6 mm	FG 0300 146 1	
2.5 mm turned	FG 0300 146 4	
2.5 mm stamped	FG 0200 146 1	
3.6 mm	FG 0300 146 3	



Contact size	Part Number	Figure
Removal tool for modules	FG 1000 146	
Blank modules	C146 A00 001 E8 (pin) C146 B00 001 E8 (socket)	
Module coupler	C146 10Z000 002 8	
Assembly angle	C146 10Z001 001 8	
Strain relief	C146 10Z002 001 8	

The image shows a close-up of industrial machinery, likely a pump or valve assembly. The main components are painted a vibrant blue. In the upper center, there is a large, cylindrical stainless steel component. To its left, a circular pressure gauge with a white face and black markings is mounted. Several large, black handwheels for manual operation are visible. The machinery is connected to various pipes and fittings, some of which are also blue, while others are silver metal. The background is a plain, light-colored wall.

# heavy | mate<sup>®</sup> Q

- Compact design
- Even in a metal housing
- Rated voltage up to 500 V
- Numbers of contacts: 5 + PE, 7 + PE







Approvals, Testhouse	Characteristics	Approval-Number
UL 	In preparation	In preparation
CSA 	In preparation	In preparation

## heavy|mate® Q Characteristics contact inserts 5 + PE

General Characteristics	Standard	Value
Number of contacts		5 + PE
Termination technique		crimp
Wire gauge		0.5 – 4.0 mm <sup>2</sup> (AWG 20-12)
Flammability	UL94	V-0
Electrical Characteristics		
Rated voltage	IEC 60664-1	400 V (conductor – conductor) 230 V (conductor – earth)
Pollution degree	IEC 60664-1	3
Installation (overvoltage) category	IEC 60664-1	3
Material group	IEC 60664-1	3b
Rated impulse withstand voltage	IEC 60664-1	6 kV
Current carrying capacity	IEC 60512-5-2	see derating curves
Contact resistance	IEC 60512-2-1	≤ 5 mΩ
Insulation resistance	IEC 60512-3-1	≥ 10 <sup>10</sup> Ω
Climatical Characteristics		
Climatic category	IEC 60068-1	40/125/21
Upper temperature	IEC 60512-11-9	+125°C
Lower temperature	IEC 60512-11-10	-40°C
Mechanical Characteristics		
Mechanical operation	IEC 60512-9-1	≥500 mating cycles
Materials		
Insert		PC
Colour insert		grey
Contacts		Cu-alloy
Contact plating		Ag (silver) /Au (gold)

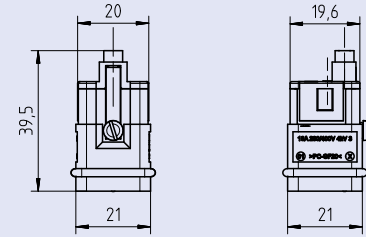
### Derating Curves

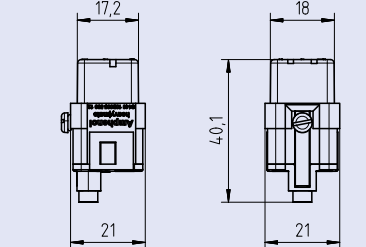
In preparation

Description	Part Number	Drawing	Figure
<b>Contact insert 5 +PE (Please order contacts separately)</b>			
Male insert	C146 10A005 500 12		
Female insert	C146 10B005 500 12		
<b>Coding element</b>			
Coding element	N17 045 000 1		

**Contact arrangement**



Supplied as	for wire gauge	AWG	Pieces	Part Number		Figure
				Male contact	Female contact	
<b>Turned 2.5 mm crimp contacts single contact</b>						
silver plating	0.5 mm <sup>2</sup>	20	100	VN01 025 0035 1C	VN02 025 0035 1C	
	0.75 - 1.0 mm <sup>2</sup>	18	100	VN01 025 0036 1C	VN02 025 0036 1C	
	1.5 mm <sup>2</sup>	16	100	VN01 025 0037 1C	VN02 025 0037 1C	
	2.5 mm <sup>2</sup>	14	100	VN01 025 0038 1C	VN02 025 0038 1C	
	4.0 mm <sup>2</sup>	12	100	VN01 025 0039 1C	VN02 025 0039 1C	
gold plating	0.5 mm <sup>2</sup>	20	100	VN01 025 0035 2C	VN02 025 0035 2C	
	0.75 - 1.0 mm <sup>2</sup>	18	100	VN01 025 0036 2C	VN02 025 0036 2C	
	1.5 mm <sup>2</sup>	16	100	VN01 025 0037 2C	VN02 025 0037 2C	
	2.5 mm <sup>2</sup>	14	100	VN01 025 0038 2C	VN02 025 0038 2C	
	4.0 mm <sup>2</sup>	12	100	VN01 025 0039 2C	VN02 025 0039 2C	

## heavy|mate® Q Characteristics contact inserts 7 + PE

General Characteristics	Standard	Value
Number of contacts		7 + PE
Termination technique		crimp
Wire gauge		0.14 – 2.5mm <sup>2</sup> (AWG 26-14)
Flammability	UL94	V-0
Electrical Characteristics		
Rated voltage	IEC 60664-1	400V
Pollution degree	IEC 60664-1	3
Installation (overvoltage) category	IEC 60664-1	3
Material group	IEC 60664-1	3b
Rated impulse withstand voltage	IEC 60664-1	6.0 kV
Current carrying capacity	IEC 60512-5-2	see derating curves
Contact resistance	IEC 60512-2-1	≤ 5 mΩ
Insulation resistance	IEC 60512-3-1	≥ 10 <sup>10</sup> Ω
Climatical Characteristics		
Climatic category	IEC 60068-1	40/125/21
Upper temperature	IEC 60512-11-9	+125°C
Lower temperature	IEC 60512-11-10	-40°C
Mechanical Characteristics		
Mechanical operation	IEC 60512-9-1	≥500 mating cycles
Materials		
Insert		PC
Colour insert		grey
Contacts		Cu-alloy
Contact plating		Ag (silver) /Au (gold)
Derating Curves		
In preparation		



Description	Part Number	Drawing	Figure
-------------	-------------	---------	--------

**Contact insert 7 + PE (Please order contacts separately)**

Male insert	C146 10A007 500 12		
Female insert	C146 10B007 500 12		

**Coding element**

Male insert	N17 059 000 1	
Female insert	N17 059 000 2	

**Contact arrangement**



Supplied as	for wire gauge	AWG	Pieces	Part Number		Figure
				Male contact	Female contact	

**Turned 1.6 mm crimp contacts single contact**

silver plating	0.14 - 0.37 mm <sup>2</sup>	26-22	100	VN01 016 0024 1C	VN02 016 0024 1C	
	0.5 mm <sup>2</sup>	20	100	VN01 016 0025 1C	VN02 016 0025 1C	
	0.75 - 1.0 mm <sup>2</sup>	20-16	100	VN01 016 0026 1C	VN02 016 0026 1C	
	1.5 mm <sup>2</sup>	16-15	100	VN01 016 0027 1C	VN02 016 0027 1C	
	2.5 mm <sup>2</sup>	14	100	VN01 016 0028 1C	VN02 016 0028 1C	
gold plating	0.14 - 0.37 mm <sup>2</sup>	26-22	100	VN01 016 0024 2C	VN02 016 0024 2C	
	0.5 mm <sup>2</sup>	20	100	VN01 016 0025 2C	VN02 016 0025 2C	
	0.75 - 1.0 mm <sup>2</sup>	20-16	100	VN01 016 0026 2C	VN02 016 0026 2C	
	1.5 mm <sup>2</sup>	16-15	100	VN01 016 0027 2C	VN02 016 0027 2C	
	2.5 mm <sup>2</sup>	14	100	VN01 016 0028 2C	VN02 016 0028 2C	



# heavy | mate<sup>®</sup> Housings

## Available Types

- Standard-Housings IP65
- Housings in IP67 and IP68
- EMC-Housings
- Corrosion resistant Housings

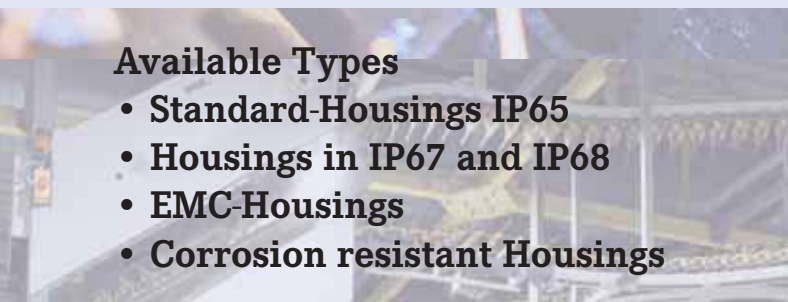



#### General information

- The connectors of our heavy|mate® series are designed for use in machine tools, general electric installations and applications as well as for industrial control and other electrical equipment. Other applications than the above mentioned are in the responsibility of the user.
- For cable to cable connections a suitable cable clamp has to be used.
- The indicated dimensions with the panel cut-outs represent reference values and are in the concrete application with products to be co-ordinated.
- The sealing area of the housing has to be level and free of burrs.
- Housings in accordance with DIN EN 175 301 - 801 (DIN 43 652) .

Range of housings

Size A3/4



Size A10



Size A16



Size A32



Size E6



Size E10



Size E16



Size E24













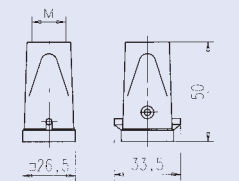

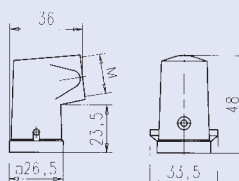

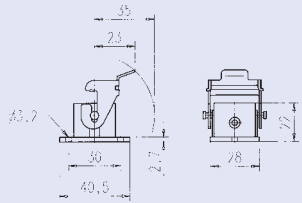
Size E48

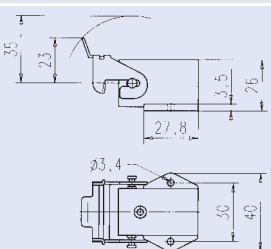

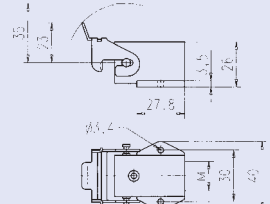
## heavy|mate® Housings standard Characteristics

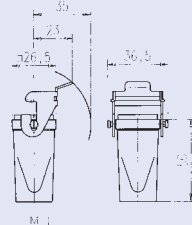
General Characteristics	Standard	Value
Protection class housing		IP 65
Protection class spring cover locked spring loaded		IP 65 IP 54
Locking system	DIN EN 175 301-801 (DIN 43 652)	1 locking lever 2 locking levers
Climatical Characteristics		
Climatic category	IEC 60068-1	40 / 125 / 21
Temperature range	IEC 60068-1	- 40 °C / + 125 °C
Upper temperature	IEC 60512-11-9	+ 125 °C
Lower temperature	IEC 60512-11-10	- 40 °C
Mechanical Characteristics		
Mechanical operation	IEC 60512-9-1	≥ 500 mating cycles
Materials		
Housings	DIN EN 175 301-801 (DIN 43 652)	Aluminium die cast alloy
Thermoplastic housing		PA
Metal housing D 7		Zinc die cast alloy
Protective cover		PA
Rubber gasket		NBR
Locking lever		steel / zinc coated
Surface EMV housings		special surface

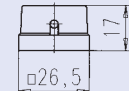
Description	M	Part Number	Drawing	Figure
<b>Hoods</b>				
Hood top entry	20	C146 10R003 600 4		
Hood side entry	20	C146 10R003 500 4		
<b>Housings</b>				
Housing bulkhead mounting with gasket	-	C146 10F003 000 4		
Housing bulkhead end mounting with gasket	-	C146 10F003 004 4		
Housing single side entry with gland bushing	20	C146 10N003 500 4		
Hood cable to cable coupling	20	C146 10R003 804 4		
<b>Protective cover (only in connection with male insert)</b>				
Cover for housings	-	C146 10Z003 100 4		

Description	M	Part Number	Drawing	Figure
<b>Hoods</b>				
Hood top entry	20	C146 30R003 600 4		
Hood side entry	20	C146 30R003 500 4		
<b>Housings</b>				
Housing bulkhead mounting with gasket	-	C146 30F003 000 4		
Housing bulkhead end mounting with gasket	-	C146 30F003 004 4		
Housing single side entry with gland bushing	20	C146 30N003 500 4		
Hood cable to cable coupling	20	C146 30R003 804 4		
<b>Protective cover (only in connection with male insert)</b>				
Cover for housings	-	C146 30Z003 100 4		











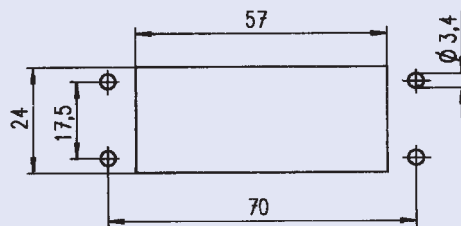

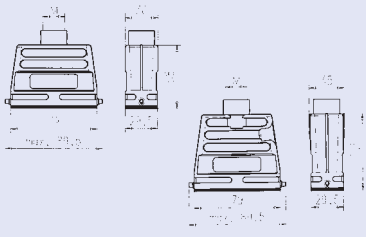
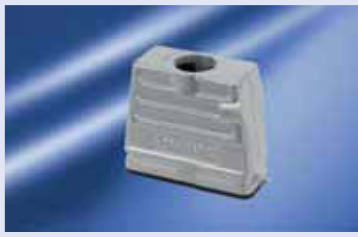
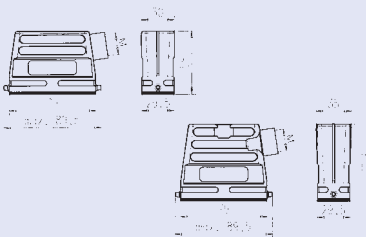

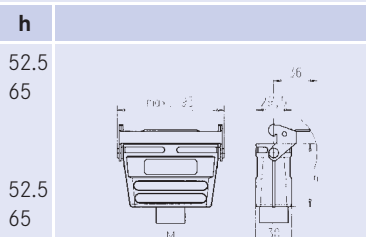

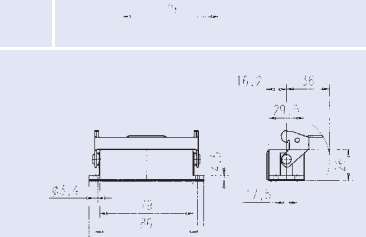

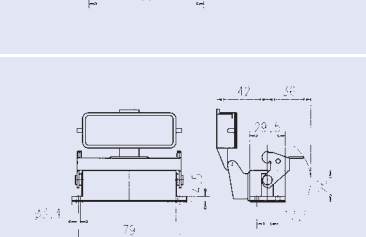
# heavy|mate® Housings standard Size A10

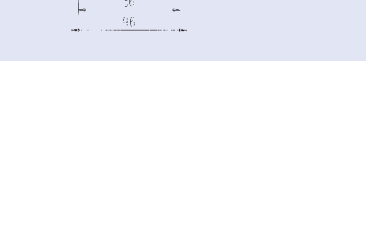
Description	M	Part Number	Drawing	Figure
<b>Housings</b>				
Housing single side entry	25	C146 10N015 500 2	<p>1 closed if single entry</p>	
Housing double side entry	25	C146 10N015 600 2		
Housing with spring cover single side entry	25	C146 10N015 806 2	<p>1 closed if single entry</p>	
Housing with spring cover double side entry	20 25	C146 10N015 607 2 C146 10N015 606 2		
<b>Protective cover</b>				
Cover for housings	-	C146 10Z015 100 2		

## Panel cut out

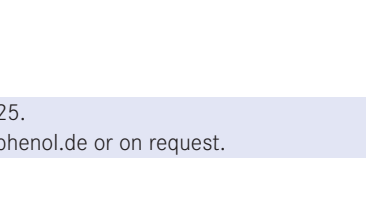

Description	M	Part Number	Drawing	Figure	
<b>Hoods</b>					
Hood top entry low profile	20	C146 21R016 650 4			
	25	C146 21R016 600 4			
Hood top entry high profile	20	C146 21R025 650 2			
	25	C146 21R025 600 2			
Hood side entry low profile	20	C146 21R016 550 4			
	25	C146 21R016 500 4			
Hood side entry high profile	20	C146 21R025 550 2			
	25	C146 21R025 500 2			
<b>Housings</b>			<b>h</b>		
Hood coupling application low profile	20	C146 21R016 854 4		52.5 65	
	25	C146 21R016 804 4			
Hood coupling application high profile	20	C146 21R025 854 2		52.5 65	
	25	C146 21R025 804 2			
Housing bulkhead mounting with gasket	-	C146 10F025 000 2			
Housing bulkhead mounting with spring cover with gasket	-	C146 10F025 003 2			

# heavy|mate® Housings standard Size A16

Description	M	Part Number	Drawing	Figure
<b>Housings</b>				
Housing single side entry	25	C146 10N025 500 2	<p>1 closed if single entry</p>	
Housing double side entry	20 25	C146 10N025 601 2 C146 10N025 600 2		
Housing with spring cover single side entry	25	C146 10N025 806 2	<p>1 closed if single entry</p>	
Housing with spring cover double side entry	20 25	C146 10N025 607 2 C146 10N025 606 2		

## Protective cover

Cover for housings	-	C146 10Z025 100 2		
--------------------	---	-------------------	--	--

## Panel cut out

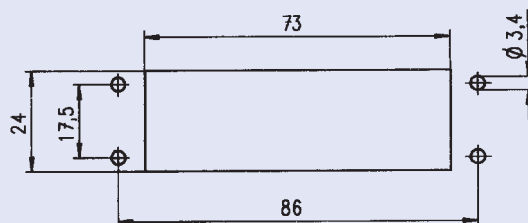

Description	M	Part Number	Drawing	Figure
<b>Hoods</b>				
Hood top entry	25 32	C146 21R032 650 4 C146 21R032 600 4		
Hood side entry	25 32	C146 21R032 550 4 C146 21R032 500 4		
Hood coupling application	25 32	C146 21R032 852 4 C146 21R032 802 4		
Hood top entry	25 32	C146 21R032 652 4 C146 21R032 602 4		
Hood side entry	25 32	C146 21R032 552 4 C146 21R032 502 4		

Description	M	Part Number	Drawing	Figure
<b>Housings</b>				
Housing bulkhead mounting with gasket	-	C146 10F032 000 4		
Housing single side entry	25 32	C146 10N032 550 4 C146 10N032 500 4		
Housing double side entry	25 32	C146 10N032 650 4 C146 10N032 600 4		

**Panel cut out**

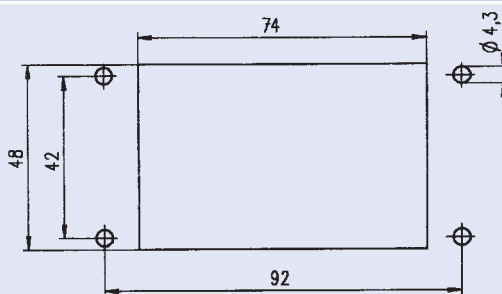

Description	M	Part Number	Drawing	Figure
<b>Hoods</b>				
Hood top entry low profile	16	C146 21R006 656 1		
	20	C146 21R006 606 1		
Hood top entry high profile	25	C146 21R006 656 8		
	32	C146 21R006 606 8		
Hood side entry low profile	20	C146 21R006 506 1		
	25	C146 21R006 507 1		
Hood side entry high profile	25	C146 21R006 556 8		
	32	C146 21R006 506 8		
<b>Housings</b>			<b>h</b>	
Hood coupling application low profile	20	C146 21R006 804 1	52	
Hood coupling application high profile	25	C146 21R006 854 8	70	
Housing bulkhead mounting with gasket	-	C146 10F006 000 1		
Housing bulkhead mounting with thermoplastic spring cover with gasket	-	C146 10F006 003 1		
Housing bulkhead mounting with metal spring cover with gasket	-	C146 30F006 003 1		



Description	M	Part Number	Drawing	Figure
<b>Housings</b>				
Housing single side entry low profile	20	C146 10N006 803 1		
Housing single side entry high profile	32	C146 10N006 802 2		
1 closed if single entry				
Housing double side entry low profile	20	C146 10N006 603 1		
Housing double side entry high profile	25 32	C146 10N006 603 2 C146 10N006 602 2		
1 closed if single entry				
Housing with spring cover single side entry low profile	20 25	C146 10N006 807 1 C146 10N006 806 1		
Housing with spring cover single side entry high profile	25 32	C146 10N006 807 2 C146 10N006 806 2		
1 closed if single entry				
Housing with spring cover double side entry low profile	20	C146 10N006 607 1		
Housing with spring cover double side entry high profile	25 32	C146 10N006 607 2 C146 10N006 606 2		
<b>Protective cover</b>				
Cover for housings	-	C146 10Z006 100 1		
Cover for hoods	-	C146 10Z006 200 1		

**Panel cut out**



Description	M	Part Number	Drawing	Figure
<b>Hoods</b>				
Hood top entry low profile	20	C146 21R010 650 1		
	25	C146 21R010 600 1		
Hood top entry high profile	25	C146 21R010 650 8		
	32	C146 21R010 600 8		
Hood side entry low profile	20	C146 21R010 550 1		
	25	C146 21R010 500 1		
Hood side entry high profile	25	C146 21R010 550 8		
	32	C146 21R010 500 8		
<b>Housings</b>			<b>h</b>	
Hood coupling application low profile	20	C146 21R010 852 1		
	25	C146 21R010 802 1		
Hood coupling application high profile	25	C146 21R010 852 8		
	32	C146 21R010 802 8		
Housing bulkhead mounting with gasket	-	C146 10F010 000 1		
Right-angled housing with gasket	-	C146 10F010 090 1		

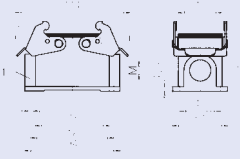

Description	M	Part Number	Drawing	Drawing
<b>Housings</b>			<b>h</b>	
Housing single side entry low profile	20	C146 10N010 501 1	57	 
	25	C146 10N010 500 1	57	
Housing single side entry high profile	25	C146 10N010 501 2	74	 
	32	C146 10N010 500 2	74	
			Screw plug for one cable entry	
Housing double side entry low profile	20	C146 10N010 601 1	57	 
	25	C146 10N010 601 2	74	
Housing double side entry high profile	32	C146 10N010 600 2	74	

**Panel cut out**



Description	M	Part Number	Drawing	Figure
<b>Hoods</b>				
Hood top entry low profile	20	C146 21R010 656 1		
	25	C146 21R010 606 1		
	32	C146 21R010 607 1		
Hood top entry high profile	25	C146 21R010 656 8		
	32	C146 21R010 606 8		
	40	C146 21R010 607 8		
Hood side entry low profile	20	C146 21R010 556 1		
	25	C146 21R010 506 1		
Hood side entry high profile	25	C146 21R010 556 8		
	32	C146 21R010 506 8		
<b>Housings</b>			<b>h</b>	
Hood coupling application low profile	20	C146 21R010 854 1		
	25	C146 21R010 804 1		
	32	C146 21R010 805 1		
Hood coupling application high profile	25	C146 21R010 854 8		
	32	C146 21R010 804 8		
	40	C146 21R010 805 8		
Housing bulkhead mounting with gasket	-	C146 10F010 001 1		
Housing bulkhead mounting with thermoplastic spring cover with gasket	-	C146 10F010 003 1		
Housing bulkhead mounting with metal spring cover with gasket	-	C146 30F010 003 1		

Description	M	Part Number	Drawing	Figure
<b>Housings</b>			<b>h</b>	
Housing single side entry low profile	20	C146 10N010 803 1	57	
Housing single side entry high profile	25 32	C146 10N010 803 2 C146 10N010 802 2	74 74	
			1 closed if single entry	
Housing double side entry low profile	20	C146 10N010 603 1	57	
Housing double side entry high profile	25	C146 10N010 603 2	74	
			1 closed if single entry	
Housing with spring cover single side entry low profile	20	C146 10N010 807 1	57	
Housing with spring cover single side entry high profile	25 32	C146 10N010 807 2 C146 10N010 806 2	74 74	
			1 closed if single entry	
Housing with spring cover double side entry low profile	20	C146 10N010 607 1	57	
Housing with spring cover double side entry high profile	25 32	C146 10N010 607 2 C146 10N010 606 2	74 74	

Description	M	Part Number	Drawing	Figure
<b>Hoods</b>				
Hood top entry low profile	20	C146 21R010 652 1		
Hood top entry high profile	25 32	C146 21R010 652 8 C146 21R010 602 8		
Hood side entry low profile	20	C146 21R010 552 1		
Hood side entry high profile	25 32	C146 21R010 552 8 C146 21R010 502 8		
<b>Housings</b>				
Housing with spring cover with gasket	-	C146 10F010 002 1		

Description	M	Part Number	Drawing	Figure
<b>Housings</b>				
Housing single side entry low profile	20	C146 10N010 509 1	57	
Housing single side entry high profile	32	C146 10N010 508 2	74	
				1 closed if single entry
Housing double side entry low profile	20	C146 10N010 609 1	57	
Housing double side entry high profile	25	C146 10N010 609 2	74	
Housing with spring cover single side entry low profile	20	C146 10N010 805 1	57	
Housing with spring cover single side entry high profile	32	C146 10N010 804 2	74	
				1 closed if single entry
Housing with spring cover double side entry low profile	20	C146 10N010 605 1	57	
Housing with spring cover double side entry high profile	32	C146 10N010 604 2	74	

Description	M	Part Number	Drawing	Figure
<b>Hoods</b>				
Hood 2 top entry high profile	25	C146 10R010 902 8		
<b>Protective cover (only in connection with male insert)</b>				
Cover for housings	-	C146 10Z010 100 1		
Cover for hoods	-	C146 10Z010 200 1		
<b>Further special housings on request.</b>				

Description	M	Part Number	Drawing	Figure
<b>Hoods</b>				
Hood top entry low profile	25	C146 21R016 650 1		
	32	C146 21R016 600 1		
Hood top entry high profile	32	C146 21R016 600 8		
	40	C146 21R016 601 8		
Hood side entry low profile	25	C146 21R016 550 1		
	32	C146 21R016 500 1		
Hood side entry high profile	32	C146 21R016 500 8		
	40	C146 21R016 501 8		
<b>Housings</b>			<b>h</b>	
Hood coupling application low profile	25	C146 21R016 852 1		
	32	C146 21R016 802 1		
Hood coupling application high profile	32	C146 21R016 802 8		
	40	C146 21R016 803 8		
Housing bulkhead mounting with gasket	-	C146 10F016 000 1		
Housing single side entry low profile	25	C146 10N016 500 1		
Housing single side entry high profile	32	C146 10N016 500 2		
Housing double side entry low profile	25	C146 10N016 600 1		
Housing double side entry high profile	25 32	C146 10N016 601 2 C146 10N016 600 2		

**Panel cut out**



Description	M	Part Number	Drawing	Figure
<b>Hoods</b>				
Hood top entry low profile	25	C146 21R016 656 1		
	32	C146 21R016 606 1		
Hood top entry high profile	32	C146 21R016 606 8		
	40	C146 21R016 607 8		
Hood side entry low profile	25	C146 21R016 556 1		
	32	C146 21R016 506 1		
Hood side entry high profile	32	C146 21R016 506 8		
	40	C146 21R016 507 8		
<b>Housings</b>			<b>h</b>	
Hood coupling application low profile	25	C146 21R016 854 1		
	32	C146 21R016 804 1		
Hood coupling application high profile	32	C146 21R016 804 8		
	40	C146 21R016 805 8		
Housing bulkhead mounting with gasket	-	C146 10F016 001 1		
Housing bulkhead mounting with thermoplastic spring cover with gasket	-	C146 10F016 003 1		
Housing bulkhead mounting with metal spring cover with gasket	-	C146 30F016 003 1		



Description	M	Part Number	Drawing	Figure
<b>Housings</b>			<b>h</b>	
Housing single side entry low profile	25	C146 10N016 802 1	64	
Housing single side entry high profile	32	C146 10N016 802 2	77	
Housing double side entry low profile	25	C146 10N016 602 1	64	
Housing double side entry high profile	25 32	C146 10N016 603 2 C146 10N016 602 2	77 77	
Housing with spring cover single side entry low profile	25	C146 10N016 806 1	64	
Housing with spring cover single side entry high profile	32	C146 10N016 806 2	77	
Housing with spring cover double side entry low profile	25	C146 10N016 606 1	64	
Housing with spring cover double side entry high profile	25 32	C146 10N016 607 2 C146 10N016 606 2	77 77	

Description	M	Part Number	Drawing	Figure
<b>Hoods</b>				
Hood top entry low profile	25	C146 21R016 652 1		
	32	C146 21R016 602 1		
Hood top entry high profile	32	C146 21R016 602 8		
	40	C146 21R016 603 8		
Hood side entry low profile	25	C146 21R016 552 1		
	32	C146 21R016 502 1		
Hood side entry high profile	32	C146 21R016 502 8		
	40	C146 21R016 503 8		
<b>Housings</b>				
Housing bulkhead mounting with spring cover with gasket	-	C146 10F016 002 1		

Description	M	Part Number	Drawing	Figure
<b>Housings</b>			<b>h</b>	
Housing single side entry low profile	25	C146 10N016 508 1	64	
Housing single side entry high profile	32	C146 10N016 508 2	77	
			1 closed if single entry	
Housing double side entry low profile	25	C146 10N016 608 1	64	
Housing double side entry high profile	32	C146 10N016 608 2	77	
Housing with spring cover single side entry low profile	25	C146 10N016 804 1	64	
Housing with spring cover single side entry high profile	32	C146 10N016 804 2	77	
			1 closed if single entry	
Housing with spring cover double side entry low profile	25	C146 10N016 604 1	64	
Housing with spring cover double side entry high profile	32	C146 10N016 604 2	77	



Description	M	Part Number	Drawing	Figure
<b>Hoods</b>				
Hood 2 top entry high profile	25 32	C146 10R016 910 8 C146 10R016 902 8		
<b>Protective cover (only in connection with male insert)</b>				
Cover for housings	-	C146 10Z016 200 1		
Cover for hoods	-	C146 10Z016 100 1		
<b>Further special housings on request.</b>				







Description	M	Part Number	Drawing	Figure	
<b>Hoods</b>					
Hood top entry low profile	25	C146 21R024 650 1			
	32	C146 21R024 600 1			
Hood top entry high profile	32	C146 21R024 600 8			
	40	C146 21R024 601 8			
Hood side entry low profile	25	C146 21R024 550 1			
	32	C146 21R024 500 1			
Hood side entry high profile	32	C146 21R024 500 8			
	40	C146 21R024 501 8			
<b>Housings</b>			<b>h</b>		
Hood coupling application low profile	25	C146 21R024 852 1		62	
	32	C146 21R024 802 1			
Hood coupling application high profile	32	C146 21R024 802 8		76	
	40	C146 21R024 803 8			
Housing bulkhead mounting with gasket	-	C146 10F024 000 1			
Housing single side entry low profile	25	C146 10N024 500 1		64	
Housing single side entry high profile	32	C146 10N024 500 2		80	
				1 closed if single entry	
Housing double side entry low profile	25	C146 10N024 600 1		64	
Housing double side entry high profile	25	C146 10N024 601 2		80	
	32	C146 10N024 600 2		80	

**Panel cut out**

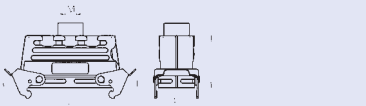

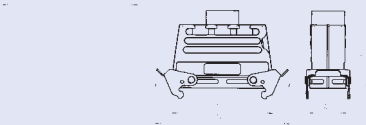
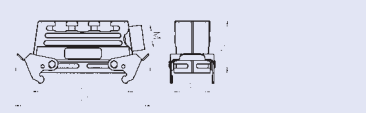

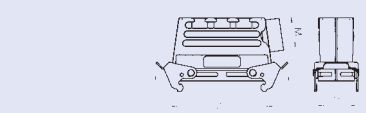
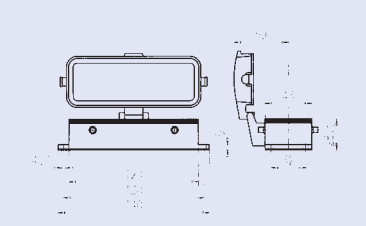

Description	M	Part Number	Drawing	Figure
<b>Hoods</b>				
Hood top entry low profile	25	C146 21R024 656 1		
	32	C146 21R024 606 1		
Hood top entry high profile	32	C146 21R024 606 8		
	40	C146 21R024 607 8		
Hood side entry low profile	25	C146 21R024 556 1		
	32	C146 21R024 506 1		
Hood side entry high profile	32	C146 21R024 506 8		
	40	C146 21R024 507 8		
<b>Housings</b>			<b>h</b>	
Hood coupling application low profile	25	C146 21R024 854 1		
	32	C146 21R024 804 1		
Hood coupling application high profile	32	C146 21R024 804 8		
	40	C146 21R024 805 8		
Housing bulkhead mounting with gasket	-	C146 10F024 001 1		
Housing bulkhead mounting with thermoplastic spring cover with gasket	-	C146 10F024 003 1		
Housing bulkhead mounting with metal spring cover with gasket	-	C146 30F024 003 1		

Description	M	Part Number	Drawing	Figure
<b>Hoods</b>			<b>h</b>	
Housing single side entry low profile	25	C146 10N024 802 1	64	
Housing single side entry high profile	32	C146 10N024 802 2	80	
			1 closed if single entry	
Housing double side entry low profile	25	C146 10N024 602 1	64	
Housing double side entry high profile	32	C146 10N024 602 2	80	
Housing with spring cover single side entry low profile	25	C146 10N024 806 1	64	
Housing with spring cover single side entry high profile	32	C146 10N024 806 2	80	
			1 closed if single entry	
Housing with spring cover double side entry low profile	25	C146 10N024 606 1	64	
Housing with spring cover double side entry high profile	32	C146 10N024 606 2	80	

Description	M	Part Number	Drawing	Figure
<b>Hoods</b>				
Hood top entry low profile	25	C146 21R024 652 1		
	32	C146 21R024 602 1		
Hood top entry high profile	32	C146 21R024 602 8		
	40	C146 21R024 603 8		
Hood side entry low profile	25	C146 21R024 552 1		
	32	C146 21R024 502 1		
Hood side entry high profile	32	C146 21R024 502 8		
	40	C146 21R024 503 8		
<b>Housings</b>				
Housing bulkhead mounting with spring cover with gasket	-	C146 10F024 002 1		



Description	M	Part Number	Drawing	Figure
<b>Housings</b>				
Housing single side entry low profile	25	C146 10N024 508 1	64	
Housing single side entry high profile	32	C146 10N024 508 2	80	
				1 closed if single entry
Housing double side entry low profile	25	C146 10N024 608 1	64	
Housing double side entry high profile	32	C146 10N024 608 2	80	
Housing with spring cover single side entry low profile	25	C146 10N024 804 1	64	
Housing with spring cover single side entry high profile	32	C146 10N024 804 2	80	
				1 closed if single entry
Housing with spring cover double side entry low profile	25	C146 10N024 604 1	64	
Housing with spring cover double side entry high profile	32	C146 10N024 604 2	80	
	25	C146 10N024 808 1 (2)	64	

Description	M	Part Number	Drawing	Figure
<b>Hoods</b>				
Hood 2 top entry high profile	32 40	C146 10R024 903 8 C146 10R024 908 8		
<b>Protective cover (only in connection with male insert)</b>				
Cover for housings	-	C146 10Z024 200 1		
Cover for hoods	-	C146 10Z024 100 1		
<b>Further special housings on request.</b>				

Description	M	Part Number	Drawing	Figure
<b>Hoods</b>				
Hood top entry low profile	40 50	C146 21R048 607 1 C146 21R048 608 1		
Hood top entry high profile				
Hood side entry low profile	40 50	C146 21R048 507 1 C146 21R048 508 1		
Hood side entry high profile				

Description	M	Part Number	Drawing	Figure
<b>Hoods</b>				
Housing bulkhead mounting with gasket	-	C146 10F048 001 1		
Housing bulkhead mounting with spring cover with gasket	-	C146 10F048 003 1		
Housing single side entry	40	C146 10N048 803 1		
Housing with spring cover	40	C146 10N048 807 1		

**Panel cut out**

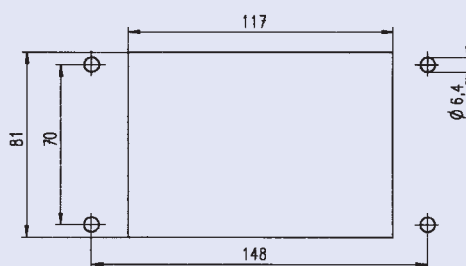

Description	M	Part Number	Drawing	Figure
<b>Hoods</b>				
Hood top entry low profile	25	C146 10R024 650 3		
	32	C146 10R024 600 3		
Hood side entry low profile	25	C146 10R024 550 3		
	32	C146 10R024 500 3		
<b>Housings</b>				
Hood coupling application low profile	25	C146 10R024 852 3		
	32	C146 10R024 802 3		
Housing bulkhead mounting with gasket	-	C146 10F024 000 3		
Housing single side entry low profile	25	C146 10N024 500 3	<p>1 closed if single entry</p>	
Housing double side entry low profile	25	C146 10N024 600 3		

**Panel cut out**

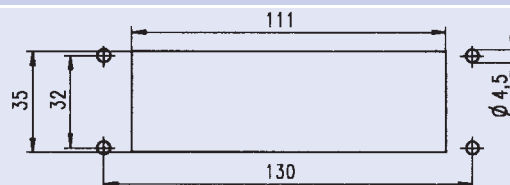



## heavy|mate® Housings IP 67 Characteristics

General Characteristics	Standard	Value
Protection class housing		IP 67
Locking system		2 locking levers
Climatical Characteristics		
Climatic category	IEC 60068-1	40 / 125 / 21
Temperature range	IEC 60068-1	- 40 °C / + 125 °C
Upper temperature	IEC 60512-11-9	+ 125 °C
Lower temperature	IEC 60512-11-10	- 40 °C
Mechanical Characteristics		
Mechanical operation	IEC 60512-9-1	≥ 500 mating cycles
Materials		
Housings		Aluminium die cast alloy
Colour housings		grey
Rubber gasket		CR
Locking lever		steel / zinc coated
Surface		powder coating







Description	M	Part Number	Drawing	Figure
<b>Hoods</b>				
Hood top entry	25	C146 67R006 607 1		
Hood side entry	25	C146 67R006 507 1		
<b>Housings</b>			<b>L1</b>	<b>L2</b>
Housing bulkhead mounting		C146 67F006 000 8	70	80
<b>Panel cut out</b>				
<p>Version A + B</p>				



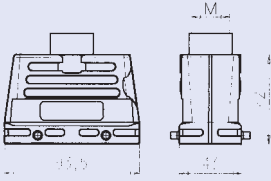

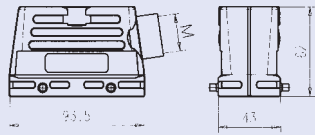

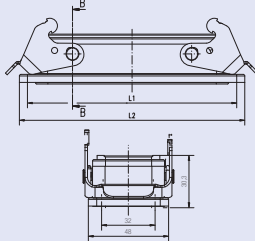

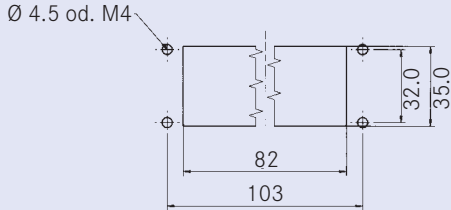
# heavy|mate® Housings IP 67 Size E10

Description	M	Part Number	Drawing	Figure
<b>Hoods</b>				
Hood top entry	25	C146 67R010 600 1		
Hood side entry	25	C146 67R010 500 1		
<b>Housings</b>			<b>L1</b>	<b>L2</b>
Housing bulkhead mounting		C146 67F010 000 8	83	93
<b>Panel cut out</b>				
<p style="text-align: center;">Version A + B</p>				

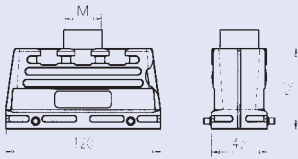
# heavy|mate® Housings IP 67 Size E16

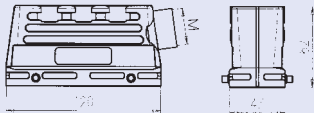
Description	M	Part Number	Drawing	Figure
<b>Hoods</b>				
Hood top entry	32	C146 67R016 600 8		
Hood side entry	32	C146 67R016 500 8		
<b>Housings</b>			<b>L1</b>	<b>L2</b>
Housing bulkhead mounting		C146 67F016 000 8	103	113
				
<b>Panel cut out</b>				
 <p>Version A + B</p>				

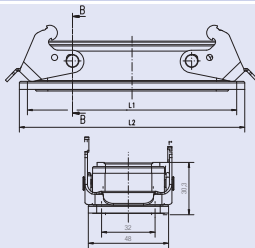
# heavy|mate® Housings IP 67 Size E24

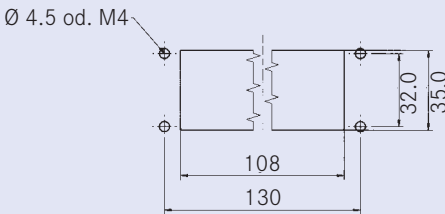
Description	M	Part Number	Drawing	Figure
<b>Hoods</b>				
Hood top entry	40	C146 67R024 601 8		
Hood side entry	40	C146 67R024 501 8		
<b>Housings</b>			<b>L1</b>	<b>L2</b>
Housing bulkhead mounting		C146 67F024 000 8	130	140
				
<b>Panel cut out</b>				
 <p>Version A + B</p>				



## heavy|mate® Housings IP 68 Characteristics

General Characteristics	Standard	Value
Protection class housing		IP 68 / IP69K
Locking system		screw M6
Climatical Characteristics		
Climatic category	IEC 60068-1	40 / 125 / 21
Temperature range	IEC 60068-1	- 40 °C / + 125 °C
Upper temperature	IEC 60512-11-9	+ 125 °C
Lower temperature	IEC 60512-11-10	- 40 °C
Mechanical Characteristics		
Mechanical operation	IEC 60512-9-1	≥ 500 mating cycles
Materials		
Housings		Aluminium die cast alloy
Colour housings		black, RAL 9005
Rubber gasket		NBR
Locking lever		stainless steel
Surface		powder coating

Description	M	Part Number	Drawing	Figure
<b>Hoods</b>				
Hood top entry	32	C146 68R006 600 8		
Hood side entry	32	C146 68R006 500 8		
<b>Housings</b>				
Housing bulkhead mounting		C146 68F006 001 1		
Housing	32	C146 68N006 500 2		

**Panel cut out**



# heavy|mate® Housings IP 68 Size 10

Description	M	Part Number	Drawing	Figure
<b>Hoods</b>				
Hood top entry	32	C146 68R010 600 8		
Hood side entry	32	C146 68R010 500 8		
<b>Housings</b>				
Housing bulkhead mounting		C146 68F010 001 1		
Housing	32	C146 68N010 500 2		

## Panel cut out

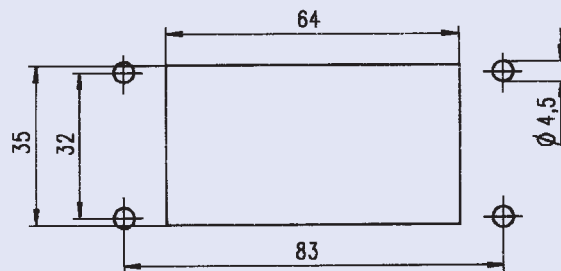

# heavy|mate® Housings IP 68 Size 16

Description	M	Part Number	Drawing	Figure
<b>Hoods</b>				
Hood top entry	40	C146 68R016 601 8		
Hood side entry	40	C146 68R016 501 8		
<b>Housings</b>				
Housing bulkhead mounting		C146 68F016 001 1		
Housing	32	C146 68N016 501 2		

## Panel cut out

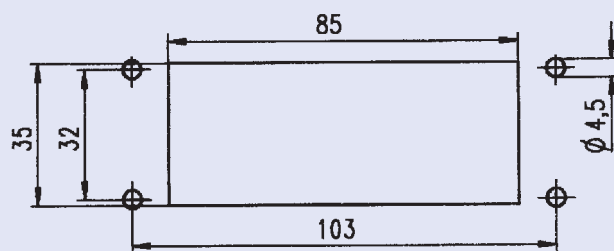



Description	M	Part Number	Drawing	Figure
<b>Hoods</b>				
Hood top entry	40	C146 68R024 601 8		
Hood side entry	40	C146 68R024 501 8		
<b>Housings</b>				
Housing bulkhead mounting		C146 68F024 001 1		
Housing	32	C146 68N024 501 2		

**Panel cut out**



**General information**

- conductive surface
- standard locking levers
- same housing dimensions like standard housings
- two housing sizes
- with or without ground strap
- high attenuation
- protection class IP 65
- mating cycles > 500



**Concept**



**Range of housings in two housing sizes**

**Version A**  
Standard flange without ground strap



**Version B**  
Standard flange with ground strap



**Version C**  
Centering flange with ground strap



## heavy|mate® Housings EMC Characteristics

General Characteristics	Standard	Value
Protection class housing		IP 65
Locking system		2 locking levers
Climatical Characteristics		
Climatic category	IEC 60068-1	40 / 125 / 21
Temperature range	IEC 60068-1	- 40 °C / + 125 °C
Upper temperature	IEC 60512-11-9	+ 125 °C
Lower temperature	IEC 60512-11-10	- 40 °C
Mechanical Characteristics		
Mechanical operation	IEC 60512-9-1	≥ 500 mating cycles
Materials		
Housings		Aluminium die cast alloy
Colour housings		grey, RAL 9005
Rubber gasket		EPDM
Locking lever		steel / zinc coated
Surface		conducting special surface

Description	M	Part Number	Drawing	Figure
<b>Hoods</b>				
Hood top entry low profile	20	C146 11R006 606 1		
	25	C146 11R006 607 1		
Hood top entry high profile	25	C146 11R006 656 8		
	32	C146 11R006 606 8		
Hood side entry low profile	16	C146 11R006 556 1		
	20	C146 11R006 506 1		
	25	C146 11R006 507 1		
Hood side entry high profile	25	C146 11R006 556 8		
	32	C146 11R006 506 8		
<b>Housings</b>				
Housing bulkhead mounting Version A Standard flange without ground strap		C146 11F006 901 8		
Housing bulkhead mounting Version B Standard flange with ground strap		C146 11F006 902 8		
Housing bulkhead mounting Version C Centering flange with ground strap		C146 11F006 001 8		

**Panel cut out**

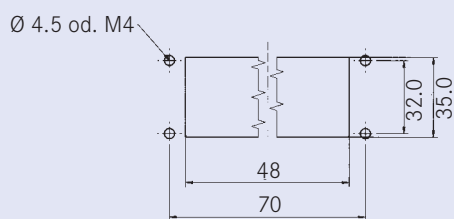

Version A + B

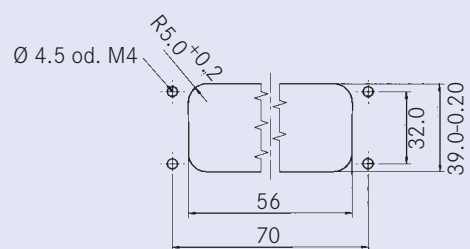

Version C

Description	M	Part Number	Drawing	Figure
<b>Hoods</b>				
Hood top entry low profile	20 25 32	C146 11R010 650 1 C146 11R010 600 1 C146 11R010 601 1		
Hood top entry high profile	25 32 40	C146 11R010 650 8 C146 11R010 600 8 C146 11R010 601 8		
Hood side entry low profile	20 25	C146 11R010 550 1 C146 11R010 500 1		
Hood side entry high profile	25 32	C146 11R010 550 8 C146 11R010 500 8		
<b>Housings</b>				
Housing bulkhead mounting Version A Standard flange without ground strap		C146 11F010 901 8		
Housing bulkhead mounting Version B Standard flange with ground strap		C146 11F010 902 8		
Housing bulkhead mounting Version C Centering flange with ground strap		C146 11F010 000 8		

**Panel cut out**



Version A + B



Version C

Description	M	Part Number	Drawing	Figure
<b>Hoods</b>				
Hood top entry low profile	25	C146 11R016 650 1		
	32	C146 11R016 600 1		
Hood top entry high profile	25	C146 11R016 650 8		
	32	C146 11R016 600 8		
	40	C146 11R016 601 8		
Hood side entry low profile	25	C146 11R016 500 1		
	32	C146 11R016 500 8		
Hood side entry high profile	25	C146 11R016 550 8		
	32	C146 11R016 500 8		
	40	C146 11R016 501 8		
<b>Housings</b>				
Housing bulkhead mounting Version A Standard flange without ground strap		C146 11F016 901 8		
Housing bulkhead mounting Version B Standard flange with ground strap		C146 11F016 902 8		
Housing bulkhead mounting Version C Centering flange with ground strap		C146 11F016 000 8		

**Panel cut out**

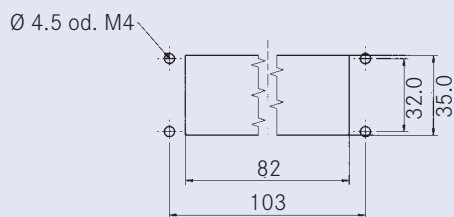

Version A + B

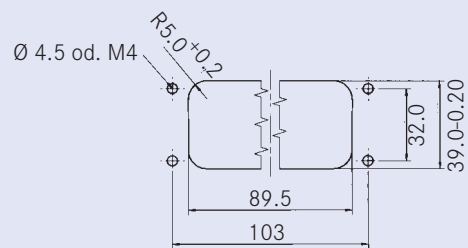

Version C

Description	M	Part Number	Drawing	Figure
<b>Hoods</b>				
Hood top entry low profile	25	C146 11R024 650 1		
	32	C146 11R024 600 1		
Hood top entry high profile	25	C146 11R024 650 8		
	32	C146 11R024 600 8		
	40	C146 11R024 601 8		
Hood side entry low profile	25	C146 11R024 550 1		
	32	C146 11R024 500 1		
Hood side entry high profile	25	C146 11R024 550 8		
	32	C146 11R024 500 8		
	40	C146 11R024 501 8		
<b>Housings</b>				
Housing bulkhead mounting Version A Standard flange without ground strap		C146 11F024 901 8		
Housing bulkhead mounting Version B Standard flange with ground strap		C146 11F024 902 8		
Housing bulkhead mounting Version C Centering flange with ground strap		C146 11F024 000 8		

**Panel cut out**



Version A + B



Version C





## heavy|mate® Housings corrosion resistant Characteristics + Notes

General Characteristics	Standard	Value
Protection class housing		IP 65
Locking system		2 locking levers
Salt mist resistance	IEC 60512-11-6:2002	>500h
Climatical Characteristics		
Climatic category	IEC 60068-1	40 / 125 / 21
Temperature range	IEC 60068-1	- 40 °C / + 125 °C
Upper temperature	IEC 60512-11-9	+ 125 °C
Lower temperature	IEC 60512-11-10	- 40 °C
Mechanical Characteristics		
Mechanical operation	IEC 60512-9-1	≥ 500 mating cycles
Materials		
Housings		Aluminium die cast alloy
Colour housings		grey, RAL 9005
Rubber gasket		NBR
Locking lever		steel / special coated
Surface		conducting special surface

### Wichtige Hinweise

500h salt mist resistance can be achieved when using a plastic cable gland.

When a metal cable gland is required, we recommend to use additionally our special studs on the hoods to achieve this value.

Order codes are:

[N16 025 0112 5X](#) Metal stud M25 corrosion resistant







[N16 032 0112 5X](#) Metal stud M32 corrosion resistant

[N16 040 0112 5X](#) Metal stud M40 corrosion resistant

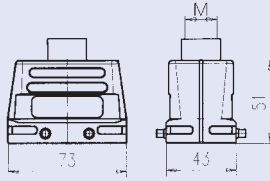
# heavy|mate® Housings corrosion resistant Size E6

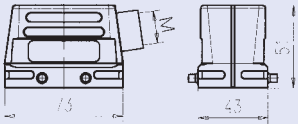
Description	M	Part Number	Drawing	Figure
<b>Hoods</b>				
Hood top entry	25	C146 50R006 607 1		
Hood side entry	25	C146 50R006 507 1		
<b>Housings</b>				
Housing bulkhead mounting		C146 50F006 000 1		
<b>Panel cut out</b>				

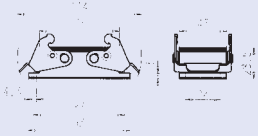

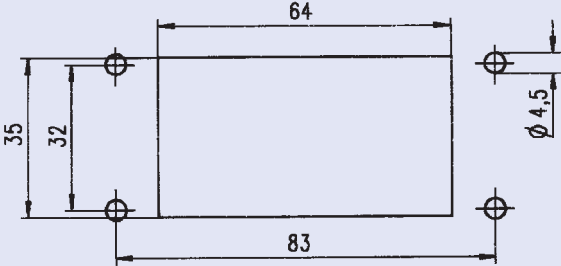

# heavy|mate® Housings corrosion resistant Size E10

Description	M	Part Number	Drawing	Figure
<b>Hoods</b>				
Hood top entry	25	C146 50R010 600 1		
Hood side entry	25	C146 50R010 500 1		
<b>Housings</b>				
Housing bulkhead mounting		C146 50F010 000 1		
<b>Panel cut out</b>				
				

# heavy|mate® Housings corrosion resistant Size E16

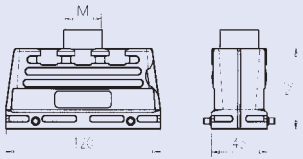
Description	M	Part Number	Drawing	Figure
<b>Hoods</b>				
Hood top entry	32	C146 50R016 600 8		
Hood side entry	32	C146 50R016 500 8		
<b>Housings</b>				
Housing bulkhead mounting		C146 50F016 000 1		
<b>Panel cut out</b>				

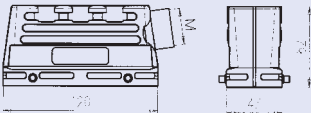
# heavy|mate® Housings corrosion resistant Size E24

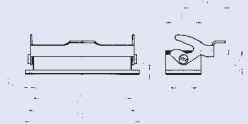
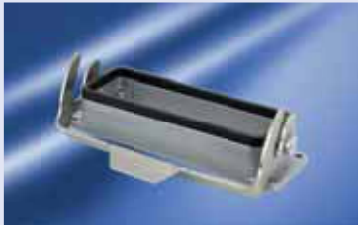
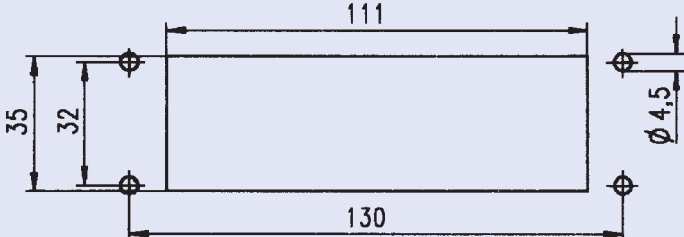
Description	M	Part Number	Drawing	Figure
<b>Hoods</b>				
Hood top entry	40	C146 50R024 601 8		
Hood side entry	40	C146 50R024 501 8		
<b>Housings</b>				
Housing bulkhead mounting		C146 50F024 000 1		
<b>Panel cut out</b>				
				



# heavy | mate<sup>®</sup> Accessories

- gland bushings
- EMC gland bushings
- Cable seals with cable clamp
- Key pin
- Guide pin / bush
- D-Sub adaptors
- Foam rubber sealing
- Label for CSA regulation



**Assembly instructions for metric clamp**

- The cable jacket should be removed as far as the underside of the cable clamping; the wire netting is then to be cut down a little further and subsequently must be formed into a circular rim. The protective jacket can remain attached to the cable provided that it passes through the lower opening of the clamp.
- On assembly, while screwing the cable clamp, the circular rim has to be pushed through and pressed on the fins commutator on the base of the underside and settle into a depression. By doing this the EMC security will remain.



Description	M	Part Number	Drawing	Figure
<b>Gland bushing IP 65<sup>1)</sup></b>				
Thermoplast clamp with variable inner diameter 10 Pieces	20	VN16 200 0114 X		
Metal with variable inner diameter 10 Pieces	20	VN16 200 0114 X		
	25	VN16 250 0114 X		
	32	VN16 320 0114 X		
	40	VN16 400 0114 X		
	50	VN16 500 0114 X		
Cable clamp without gasket 5 Pieces	16	VN16 160 0102 V		
	20	VN16 200 0102 V		
	25	VN16 250 0102 V		
	32	VN16 320 0102 V		
Cable clamp without gasket 5 Pieces	20	VN16 200 0103 V		
	25	VN16 250 0103 V		
	32	VN16 320 0103 V		

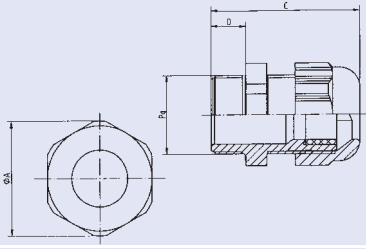

Description	Clamping range ø in mm	A in mm	M	Part Number	Drawing	Figure
<b>Gland bushing IP 67 (Material PA / - 20 °C + 80 °C)</b>						
Gland bushing with vibration protection 10 Pieces	4 - 10	20	16	VN16 160 0127 X		
	6 - 12	24	20	VN16 200 0127 X		
	9 - 16	28	25	VN16 250 0127 X		
	10 - 21	36	32	VN16 320 0127 X		
	16 - 28	46	40	VN16 400 0127 X		
Plugs brass nickel-plated with recess and o-ring 10 Pieces			20	VN16 020 0113 (1) X		
			25	VN16 025 0113 (1) X		
			32	VN16 032 0113 (1) X		
			40	VN16 040 0113 (1) X		

Description	Clamping range F in mm	M	Part Number	Drawing	Figure
<b>EMV gland bushing IP 68 (Material CuZn / PA / - 30 °C + 120 °C)</b>					
Gland bushing EMV 10 Pieces	5.5 - 10	16	VN16 160 0126 X		
	8 - 13	20	VN16 200 0126 X		
	11 - 18	25	VN16 250 0126 X		
	15 - 21	32	VN16 320 0126 X		
	19 - 27	40	VN16 400 0126 X		

Description	L	Part Number	Drawing	Figure
Key pin with lock washer 10 Pieces		VN17 050 0004 (1)		
Key pin with lock washer 100 Pieces		VN17 050 0004 (101)		
Guide pin 10 Pieces		VN13 040 0009 (1) X		
Guide socket 10 Pieces		VN13 040 0008 (1) X		
Locking screw for contact inserts <b>heavy mate</b> ® D 15, D 25, A 10, A 16 20 Pieces	23	VN03 030 0021		
Locking screw for contact inserts <b>heavy mate</b> ® D 40, D 64, E, M, H 20 Pieces	20	VN03 030 0020		
Locking set 10 Pieces		VN03 030 3000 X		

**Polarization system with key pin**

**For housings with one contact insert**



**For housings with two contact inserts**

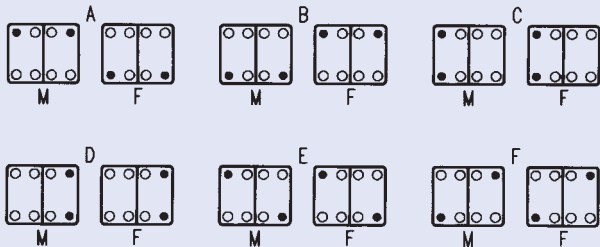

**Descriptions**

- Key pin
- Locking screw
- M Male insert
- F Female insert

**Polarization system with guide pin and guide socket**

**For housings with one contact insert**





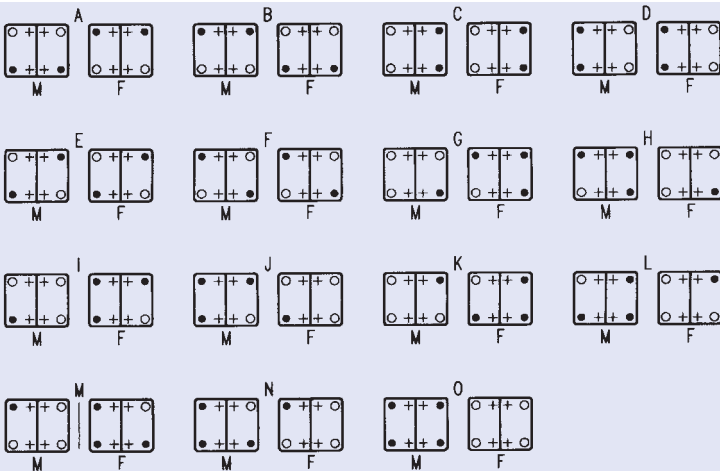



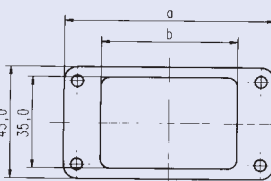

**For housings with two contact inserts**

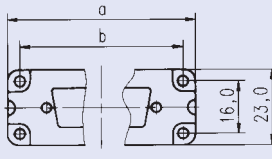

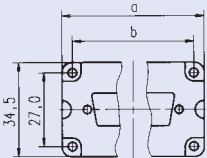
**Descriptions**

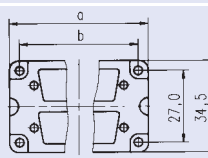
- Guide pin
- Guide socket
- + Locking screw
- M Male insert
- F Female insert









Description	Size	Part Number	a	b	D-Sub	Drawing	Figure
Foam rubber sealing 2 mm	6	N06 080 0003 1	80	70			
	10	N06 080 0003 2	93	83			
	16	N06 080 0003 3	113	103			
	24	N06 080 0003 4	140	130			
Adaptor for D-Sub set metal	15	C146 N32 015 G2	57	49,5	15	 <p>2 x adaptor 4 x M3 x 6,5 8 x M3 x 14</p>	
	25	C146 N32 025 G2	57	49,5	25		
Adaptor for D-Sub set single-row	6	C146 N32 009 G1	51,5	44	9	 <p>2 x adaptor 4 x M3 x 6,5 8 x M3 x 14</p>	
	6	C146 N32 015 G1	51,5	44	15		
	10	C146 N32 025 G1	64,5	57	25		
	16	C146 N32 037 G1	85	77,5	37		
	16	C146 N32 050 G1	85	77,5	50		
Adaptor for D-Sub set double-row	6	C146 N33 009 G1	51,5	44	9	 <p>2 x adaptor 4 x M3 x 6,5 8 x M3 x 14</p>	
	6	C146 N33 015 G1	51,5	44	15		
	10	C146 N33 025 G1	64,5	57	25		
	16	C146 N33 037 G1	85	77,5	37		
	16	C146 N33 050 G1	85	77,5	50		
Label for CSA application	N07 045 0001 L						

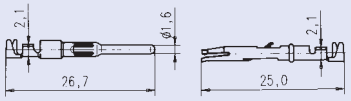
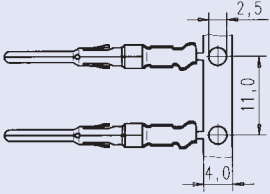

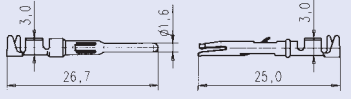
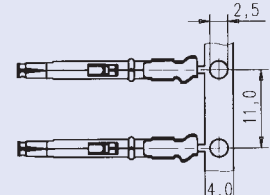

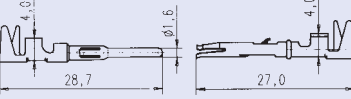
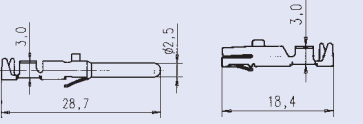
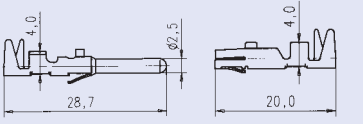
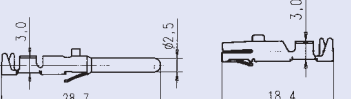
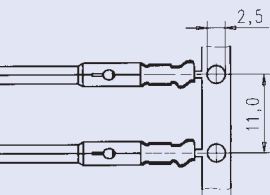
# heavy | mate<sup>®</sup> Information

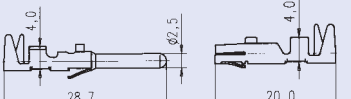
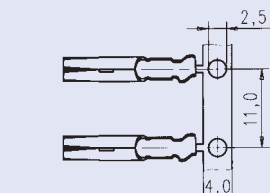
- Drawings contacts
- Safety classification
- Technical information

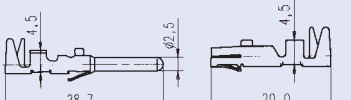
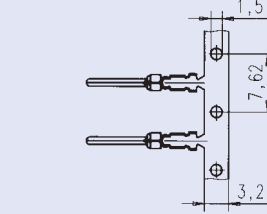
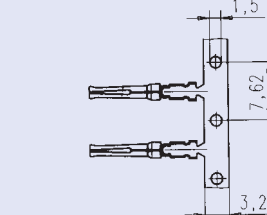
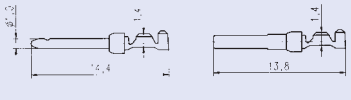
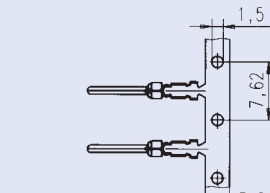
Series	Drawing single contact	Drawing contacts on reel	Figure
heavy mate® D, M	<p data-bbox="347 275 718 297">.N01 016 0003 1 .N02 016 0003 1</p>  <p data-bbox="347 461 718 517">.N01 016 0002 1 .N02 016 0002 1 .N01 016 0015 1<sup>1)</sup>.N02 016 0015 1<sup>1)</sup></p>  <p data-bbox="347 658 718 714">.N01 016 0005 1 .N02 016 0005 1 .N01 016 0016 1<sup>1)</sup>.N02 016 0016 1<sup>1)</sup></p> 	 	 
heavy mate® E, M	<p data-bbox="347 831 718 853">.N01 025 0001 1 .N02 025 0001 1</p>  <p data-bbox="347 1016 718 1039">.N01 025 0010 1 .N02 025 0010 1</p>  <p data-bbox="347 1202 718 1225">.N01 025 0043 1 .N02 025 0043 1</p> 	 	 
heavy mate® M	<p data-bbox="347 1386 718 1408">.N01 010 0130 2 .N02 010 0130 2</p>  <p data-bbox="347 1662 718 1684">.N01 010 0131 2 .N02 010 0131 2</p> 	 	 



# heavy|mate® Information Drawings turned contacts

Series	Part Number	Wire gauge	A	B	Drawing	Figure
heavy mate® <b>D, DD, M</b> 100 Pieces	VN01 016 0024 (1)C	0,14 - 0,37	0,9	2,6	.N01 016 002X 	
	VN01 016 0025 (1)C	0,5	1,1	2,6		
	VN01 016 0026 (1)C	0,75 - 1,0	1,45	2,6		
	VN01 016 0027 (1)C	1,5	1,75	3,0		
	VN01 016 0028 (1)C	2,5	2,25	3,2		
	VN02 016 0024 (1)C	0,14 - 0,37	0,9	2,6	.N02 016 002X 	
	VN02 016 0025 (1)C	0,5	1,1	2,6		
	VN02 016 0026 (1)C	0,75 - 1,0	1,45	2,6		
	VN02 016 0027 (1)C	1,5	1,75	3,0		
	VN02 016 0028 (1)C	2,5	2,25	3,2		
heavy mate® <b>E, EE</b> 100 Pieces	VN01 025 0035 (1)C	0,5	1,1	2,6	.N01 025 003X 	
	VN01 025 0036 (1)C	0,75 - 1,0	1,45	2,6		
	VN01 025 0037 (1)C	1,5	1,75	3,0		
	VN01 025 0038 (1)C	2,5	2,3	3,2		
	VN01 025 0039 (1)C	4,0	2,9	4,0		
	VN02 025 0035 (1)C	0,5	1,1	2,6	.N02 025 003X 	
	VN02 025 0036 (1)C	0,75 - 1,0	1,45	2,6		
	VN02 025 0037 (1)C	1,5	1,75	3,0		
	VN02 025 0038 (1)C	2,5	2,3	3,2		
	VN02 025 0039 (1)C	4,0	2,9	4,0		
heavy mate® <b>M</b> 100 Pieces	VN01 025 0029 (1)C	0,5	1,1	2,6	.N01 025 00XX 	
	VN01 025 0030 (1)C	0,75 - 1,0	1,45	2,6		
	VN01 025 0031 (1)C	1,5	1,75	3,0		
	VN01 025 0032 (1)C	2,5	2,25	3,45		
	VN01 025 0033 (1)C	4,0	2,85	3,9		
	VN02 025 0029 (1)C	0,5	1,1	2,6	.N02 025 00XX 	
	VN02 025 0030 (1)C	0,75 - 1,0	1,45	2,6		
	VN02 025 0031 (1)C	1,5	1,75	3,0		
	VN02 025 0032 (1)C	2,5	2,25	3,45		
	VN02 025 0033 (1)C	4,0	2,85	3,9		
	VN01 036 0004 (1)C	1,5	1,75	3,0	.N01 036 000X 	
	VN01 036 0005 (1)C	2,5	2,25	3,45		
	VN01 036 0001 (1)C	4,0	2,85	3,9		
	VN01 036 0002 (1)C	6,0	3,55	4,9		
	VN01 036 0003 (1)C	10,0	4,4	5,9		
	VN02 036 0004 (1)C	1,5	1,75	3,0	.N02 036 000X 	
VN02 036 0005 (1)C	2,5	2,25	3,45			
VN02 036 0001 (1)C	4,0	2,85	3,9			
VN02 036 0002 (1)C	6,0	3,55	4,9			
VN02 036 0003 (1)C	10,0	4,4	5,9			

Series	Part Number	Drawing single contact	Figure
heavy mate® M, FO	N01 016 0040 8		
	N02 016 0040 8		
heavy mate® M, Coax	17 DM 537 421		
	17 DM 537 401		
	17 DM 537 425		
	17 DM 537 405		



Style	enclosed	unenclosed	earthing contact	cable clamp	finger safety mated
Hood with pin insert	●		●		●
Pin insert		●	●		
Hood with socket insert	●		●		●
Socket insert		●	●		
Coupling housing with pin insert	●		●		●
Coupling housing with socket insert	●		●		●
Housing with pin insert	●		●		●
Housing with socket insert	●		●		●

If not otherwise stated the contact inserts have to be mounted in metallic conductive housings resp. on bars or mounting boards to complete the protective earth grounding.

<sup>1)</sup> When used as connector with braking capacity the load shall be reduced

<sup>2)</sup> When using cable seals (from page 224)

finger safety unmated	hand back safety mated	connetor with breaking capacity <sup>1)</sup>	rewirable	Cable clamp		Style
				with <sup>2)</sup>	without <sup>3)</sup>	
	●	●	●	●	●	Hood with pin insert
		●	●	4)	●	Pin insert
●	●	●	●	●	●	Hood with socket insert
		●	●	4)	●	Socket insert
		●	●	●	●	Coupling housing with pin insert
●	●	●	●	●	●	Coupling housing with socket insert
	●	●	●	●	●	Housing with pin insert
●	●	●	●	●	●	Housing with socket insert



**General technical information**

- The Safty of connectors/connectors with braking capacity (CBC) depends on the right selection of products, the correct installation and a proper assembly.
- Decisions for the application of connectors are the requirements of the equipment specifications. This is especially the case for the definition of the rated voltage and the related clearances and creepage distances.
- All rated data for the connectors listed in this catalogue is based on overvoltage category III and pollution degree 3 (machine tool application).
- All technical data is specified for connectors, which are not under load when mated or disconnected. If in special cases connectors can be used in the sense of plug and socket devices (connector with breaking capacity), this is mentioned in the brief information of the particular section.
- Correct mounting will protect against electrical shock when mating the connectors.
- It connectors are mounted in non conductive housings both protective earthing terminals shall be mounted.
- A detailed connector glossary can be found at the end of this catalogue.
- All mentioned excerpts of standards are for general information only. For specific cases the valid original standards have to be consulted.
- Test methods acc. IEC 60512 camply with test methods acc. DIN EN 60512 or DIN IEC 60512. IEC 60664-1 complies with DIN VDE 0110-1

**Termination methods: Screw connection**

Screw clamps are designed acc. to EN 60999-1/VDE 0609. Chart 1 below shows the screw size depending on wire size and the required clamping and testing torque.

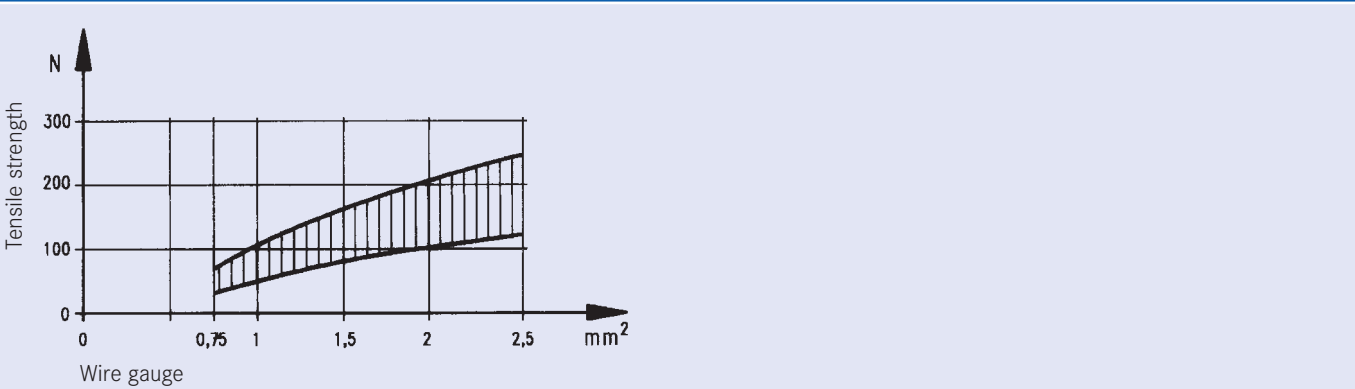

**Chart 1**

<b>Wire size (mm<sup>2</sup>)</b>	1	1.5	2.5	4	6	10
<b>Screw size</b>	M 2.6	M 3	M 3	M 3.5	M 4	M 4
<b>Test torque (Ncm)</b>	40	50	50	80	120	120

Diagram 1 below shows the range of tensile strength for a screw connection with a clamp screw M3, fastened with a torque of 50 Ncm, depending on the wire size.

**Diagram 1**



**Crimp connection**

A crimp connection is a non-detachable electrical connection between a wire and a crimp contact produced with the crimp technology. Precise crimping dies are matched to the crimp barrel and the wire size and a defined deformation results in a reliable electrical connection. There are open barrels (stamped contacts) and closed crimp barrels (turned contacts).

The main advantages of crimp connections are:

- Efficient termination of contacts.
  - Reproduceable electrical and mechanical figures by a constant crimp quality.
- (A detailed description of the crimp technology can be found in our catalogue "tools").

The requirements for crimp connections are defined in DIN EN 60352-2.

An important point for the quality of a crimp connection is the achieved tensile strength of the termination. Measuring the tensile strength is a practicable means for quality control purposes. Chart 2 below shows the required minimum tensile strength for open and closed barrels according to the wire size.

**Chart 2: Tensile strength for crimp connections**

Wire size		Tensile strength
mm <sup>2</sup>	AWG <sup>1)</sup>	N
0.05	30	6
0.08	28	11
0.12	26	15
0.14		18
0.22	24	28
0.25		32
0.32	22	40
0.5	20	60
0.75		85
0.82	18	90
1.0		108
1.3	16	135
1.5		150
2.1	14	200
2.5		230
3.3	12	275
4.0		310
5.3	10	355
6.0		360
8.4	8	370
10.0		380

**Cross reference AWG - mm<sup>2</sup>**

The chart below allows a cross reference between American Wire Gauge (AWG) and metric wire sizes (mm<sup>2</sup>).

**Chart 3**

AWG	Wire composition	Leiter-Ø	Wire size	AWG	Wire composition	Leiter-Ø	Wire size	
30	1 x 0.25	0.25 mm	0.05 mm <sup>2</sup>	20	1 x 0.81	0.81 mm	0.52 mm <sup>2</sup>	
	7 x 0.10	0.36 mm	0.06 mm <sup>2</sup>		7 x 0.32	0.97 mm	0.56 mm <sup>2</sup>	
28	1 x 0.32	0.32 mm	0.08 mm <sup>2</sup>	18	19 x 0.20	1.02 mm	0.62 mm <sup>2</sup>	
	7 x 0.13	0.38 mm	0.09 mm <sup>2</sup>		1 x 1.02	1.02 mm	0.79 mm <sup>2</sup>	
26	1 x 0.40	0.40 mm	0.13 mm <sup>2</sup>	16	19 x 0.25	1.27 mm	0.96 mm <sup>2</sup>	
	7 x 0.16	0.48 mm	0.14 mm <sup>2</sup>		19 x 0.29	1.44 mm	1.23 mm <sup>2</sup>	
	19 x 0.10	0.51 mm	0.15 mm <sup>2</sup>		14	19 x 0.36	1.80 mm	1.95 mm <sup>2</sup>
24	1 x 0.51	0.51 mm	0.21 mm <sup>2</sup>	12	19 x 0.46	2.29 mm	3.09 mm <sup>2</sup>	
	7 x 0.20	0.61 mm	0.23 mm <sup>2</sup>		10	37 x 0.40	3.10 mm	4.60 mm <sup>2</sup>
	19 x 0.13	0.64 mm	0.24 mm <sup>2</sup>			8	133 x 0.29	4.0 mm
22	1 x 0.64	0.64 mm	0.33 mm <sup>2</sup>	6	133 x 0.36	5.5 mm	13.5 mm <sup>2</sup>	
	7 x 0.25	0.76 mm	0.36 mm <sup>2</sup>					
	19 x 0.16	0.81 mm	0.38 mm <sup>2</sup>					

It has to be noted that wires of the same AWG number but with different composition have slightly different mm<sup>2</sup>.

Chart 4: Composition and Dimensions of Copper Wires

Wire Size	Wire Composition	Wire diameter
0.09 mm <sup>2</sup>	12 x 0.10	0.48 mm
0.14 mm <sup>2</sup>	18 x 0.10	0.50 mm
0.25 mm <sup>2</sup>	14 x 0.15	0.70 mm
0.34 mm <sup>2</sup>	7 x 0.25	0.78 mm
0.5 mm <sup>2</sup>	16 x 0.20	1.0 mm
0.75 mm <sup>2</sup>	24 x 0.20	1.2 mm
1.0 mm <sup>2</sup>	32 x 0.20	1.4 mm
1.5 mm <sup>2</sup>	30 x 0.25	1.6 mm
2.5 mm <sup>2</sup>	35 x 0.30	2.2 mm
4.0 mm <sup>2</sup>	56 x 0.30	2.8 mm
6.0 mm <sup>2</sup>	19 x 0.64	3.4 mm
10 mm <sup>2</sup>	19 x 0.80	4.3 mm

**Current carrying capacity**

The current carrying capacity of a connector is shown by a derating curve. The curve shows the currents that the connector can carry continuously and simultaneously through all its contacts. The curve is determined by testing following the standard DIN EN 60512. The upper temperature is limited by the contact and insulation material used. The sum of the ambient temperature and the temperature created by the current flow may not exceed the upper temperature. This means that the current carrying capacity has no fixed value but decreases with increasing ambient temperatures.

As a general example it can be said that a given connector which can carry 16A through all its contacts at 40°C ambient temperature can carry less, e.g. 12A, at an ambient temperature of 80°C. On the other hand it is often the case that not all contacts carry the whole rated current, which means that some single contacts may carry a higher current than that according to the derating curve. These currents have to be defined by testing.

Diagram 3: Typical derating curve



Chart 5: Current carrying capacity of copper wires in (A)

Installation type	Wire size (mm <sup>2</sup> )	0.25	0.34	0.5	0.75	1	1.5	2.5	4	6	10
 B1 Wires in conduits and installation channels		-	-	-	7.6	10.4	13.5	18.3	25	32	44
 B2 Cables and conductors in conduits or installation channels		-	-	-	-	9.6	12	16.5	23	29	40
 C Cables and conductors along walls		4.0	5.0	7.1	9.1	11.7	15.2	21	28	36	50
 E Cables and conductors on plank		4.0	5.0	7.1	9.1	11.5	16.1	22	30	37	52

Description according to DIN EN 60204 for PVC insulated copper wires with a working temperature of +40C. For other requirements,

such as for other temperatures, mountings, or wires corresponding correction factors are used (see next page).



**Reduction values**

The values in chart 5 are based on an ambient temperature of 40 °C. For other ambient temperatures the values have to be adjusted using the correction values of chart 6 below.

For installations with many cables and conductors under load the current carrying capacity is reduced according to the two following charts 7 and 8.

**Chart 6**

Ambient temperature (°C)	Correction value
30	1.15
35	1.03
40	1.00
45	0.91
50	0.82
55	0.71
60	0.58

**Chart 7: Reduction values for accumulated conductors**

Installation type	Number of cables and conductors / pairs under load			
	2	4	6	9
Threephase cable and conductor				
B1 and B2	0.80	0.85	0.87	0.86
C	0.65	0.75	0.78	0.76
E-one row	0.57	0.72	0.75	0.72
E-multi row	0.50	0.70	0.73	0.88
DC conductor (pair), independent of installation type	1.0	0.76	0.64	0.43

**Chart 8: Reduction values for multicore cable and conductors up to 10mm²**

Number of conductors (pairs) under load	AC (conductor > 1 mm²)	DC (Pairs 0,2 to 0,75 mm²)
5	0.75	0.52
7	0.65	0.45
10	0.55	0.39
24	0.40	0.27

Conductors of control circuits generally do not need a reduction.

**Impulse current carrying capacity**

A surge can happen to a connector and its contacts by an impulse current, e.g. through a short circuit in the system or by switching operations. The short-timed high current heat cannot be transferred outside fast enough so the contacts are stressed by the high temperature which in the worst case can lead to a local weld.

The robust design of our connectors prevents most damage by impulse currents.

The diagram 4 below can be used as a guideline.

**Chart 4: Impulse current carrying capacity of single contacts**



Curve No.	Connector style	Curve No.	Connector style
1	heavy mate® E or A with screw contact	3	heavy mate® S with stamped crimp contact
2	heavy mate® E with stamped crimp contact	4	heavy mate® D with stamped crimp contact

**Voltage grading of connectors**

**General**

Clearances and creepage distances are the base for voltage grading of connectors. Valuation and dimensioning of clearances and creepage distances have changed since the introduction of insulation coordination.

Insulation coordination comprises the selection of the electrical insulation performances of the equipment, taking into account the expected use and its environment.

The following standards apply for this:

IEC 60664-1/10.92  
Insulation coordination for equipment within low-voltage systems

DIN VDE 0110-1/4.97  
Isolationskoordination für elektrische Betriebsmittel in Niederspannungsanlagen

**Clearances**

The clearance is the shortest distance in air between two conductive parts. An important point for the dimensioning of clearances is the determination of the overvoltage category. The above standard specifies the possible overvoltages into the four following categories:

**Overvoltage category I**

Equipment intended for the use in appliances or parts of installations in which no overvoltage can occur. Examples are low-voltage equipments.

**Overvoltage category II**

Equipment intended for the use in installations or parts of it in which lightning overvoltages do not need to be considered, but switching overvoltages generated by the equipment do need to be considered. Examples are household appliances.

**Overvoltage category III**

Equipment intended for the use in installations or parts of it in which lightning overvoltages do not need to be considered, however switching overvoltages generated by the equipment, and for cases where the reliability and the availability of the equipment or its dependent circuits are subject to special requirements. Examples are protecting means, switches and sockets.

**Overvoltage category IV**

Equipment intended for the use in installations or parts of it in which lightning overvoltage has to be considered. Examples are electricity meters, overcurrent protection switches.

Once the overvoltage category has been defined the rated impulse withstand voltage can be selected for the equipment based on the nominal voltage of the supply system and the overvoltage category using chart 9 below:

**Chart 9**

Nominal voltage of the supply system in V (based on IEC 60038)	Rated impulse voltage in kV for overvoltage category			
	IV	III	II	I
Three phase systems	IV	III	II	I
230/400 277/480	6	4	2,5	1,5
400/690	8	6	4	2,5
1000	12	8	6	4

After the rated impulse withstand voltage has been selected the pollution degree must be defined taking the expected pollution around the equipment into account.

The following four degrees of pollution are established:

**Pollution degree 1**

No pollution or only dry, non-conductive pollution occurs. The pollution has no influence.

**Pollution degree 2**

Only non-conductive pollution occurs except occasionally a temporary conductivity caused by condensation is to be expected.

**Pollution degree 3**

Conductive pollution occurs or dry non-conductive pollution occurs which becomes conductive due to condensation which is to be expected.

**Pollution degree 4**

The pollution generates persistent conductivity caused by conductive dust or by rain or snow.



It has to be noted that for a connector or plug and socket device with a degree of protection of min. IP 54 the parts inside the enclosure may be dimensioned for a lower pollution degree. This also applies to mated connectors which enclosure is ensured through the connector housing and which may only be disengaged for test and maintenance purposes.

When impulse withstand voltage and the pollution degree are defined the minimum clearances can be selected from chart 10.

Chart 10

Impulse withstand voltage in kV	Minimum clearances in air in mm up to 2000 m above sea level							
	Case A (non homogeneous field)				Case B (homogeneous field)			
	Pollution degree				Pollution degree			
	1	2	3	4	1	2	3	4
0.33	0.01	0.2	0.8	1.6	0.01	0.2	0.8	1.6
0.40	0.02				0.02			
0.50	0.04				0.04			
0.60	0.06				0.06			
0.80	0.10				0.1			
1.0	0.15				0.15			
1.2	0.25	0.25			0.2			
1.5	0.5	0.5			0.3	0.3		
2.0	1.0	1.0	1.0		0.45	0.45		
2.5	1.5	1.5	1.5		0.6	0.6		
3.0	2	2	2	2	0.8	0.8		
4.0	3	3	3	3	1.2	1,2	1.2	
5.0	4	4	4	4	1.5	1.5	1.5	
6.0	5.5	5.5	5.5	5.5	2	2	2	2
8.0	8	8	8	8	3	3	3	3
10	11	11	11	11	3.5	3.5	3.5	3.5
12	14	14	14	14	4.5	4.5	4.5	4.5
15	18	18	18	18	5.5	5.5	5.5	5.5
20	25	25	25	25	8	8	8	8
25	33	33	33	33	10	10	10	10
30	40	40	40	40	12.5	12.5	12.5	12,5
40	60	60	60	60	17	17	17	17
50	75	75	75	75	22	22	22	22
60	90	90	90	90	27	27	27	27
80	130	130	130	130	35	35	35	35
100	170	170	170	170	45	45	45	45

When defining the minimum clearances for connectors generally the values of the inhomogeneous field can be chosen or the required clearance has to be defined by a voltage test.

**Creepage distances**

The creepage distance is the shortest distance along the surface of the insulating material between two conductive parts. For the dimensioning of the creepage distance the following factors are taken into account: the rated voltage, the pollution degree and the tracking formation of the insulating material.

The materials are separated into four groups according to their CTI values (Comparative Tracking Index):

- Material group I 600 ≤ CTI
- Material group II 400 ≤ CTI < 600
- Material group IIIa 175 ≤ CTI < 400
- Material group IIIb 100 ≤ CTI < 175

The minimum creepage distances can be selected from chart 11 .

Chart 11

U-eff Rated vol- tage U in V	Min. creepage distance in mm																	
	Printed circuits			Other devices														
	Pollution degree		Pollution degree 1					Pollution degree 2				Pollution degree 3			Pollution degree 4			
	1	2	Material group				Material group				Material group							
	2)	3)	2)	I	II	IIIa	IIIb	I	II	IIIa	IIIb	I	II	IIIa	IIIb			
10	0.025	0.04	0.08	0.4	0.4	0.4		1	1	1		1.6	1.6	1.6				
12.5	0.025	0.04	0.09	0.42	0.42	0.42		1.05	1.05	1.05		1.6	1.6	1.6				
16	0.025	0.04	0.1	0.45	0.45	0.45		1.1	1.1	1,1		1.6	1.6	1.6				
20	0,025	0.04	0.11	0.48	0.48	0.48		1.2	1.2	1.2		1.6	1.6	1,6				
25	0,025	0.04	0.125	0.5	0.5	0.5		1.25	1.25	1.25		1.7	1.7	1.7				
32	0.025	0.04	0.14	0.53	0.53	0.53		1.3	1.3	1.3		1.8	1.8	1.8				
40	0.025	0.04	0.16	0.56	0.8	1.1		1.4	1.6	1.8		1.9	2.4	3				
50	0.025	0.04	0.18	0.6	0.85	1.2		1.5	1.7	1.9		2	2.5	3.2				
63	0.04	0.063	0.2	0.63	0.9	1.25		1,6	1.8	2		2.1	2.6	3.4				
80	0.063	0.1	0.22	0.67	0.95	1.3		1.7	1.9	2.1		2.2	2.8	3.6				
100	0.1	0.16	0.25	0.71	1	1.4		1.8	2	2.2		2.4	3.0	3.8				
125	0.16	0.25	0.28	0.75	1.05	1.5		1.9	2.1	2.4		2.5	3.2	4				
160	0.25	0.4	0.32	0.8	1.1	1.6		2	2.2	2.5		3.2	4	5				
200	0.4	0.63	0.42	1	1.4	2		2.5	2.8	3.2		4	5	6.3				
250	0.56	1	0.56	1.25	1.8	2.5		3.2	3.6	4		5	6.3	8				
320	0.75	1.6	0.75	1.6	2.2	3.2		4	4.5	5		6.3	8	10				
400	1	2	1	2	2.8	4		5	5.6	6.3		8	10	12.5				
500	1.3	2.5	1.3	2.5	3.6	5		6.3	7.1	8.0		10	12.5	16				
630	1.8	3.2	1.8	3.2	4.5	6.3		8	9	10		12.5	16	20				
800	2.4	4	2.4	4	5.6	8		10	11	12.5		16	20	25				
1000	3.2	5	3.2	5	7.1	10		12.5	14	16		20	25	32				
1250			4.2	6.3	9	12.5		16	18	20		25	32	40				
1600			5.6	8	11	16		20	22	25		32	40	50				
2000			7.5	10	14	20		25	28	32		40	50	63				
2500			10	12.5	18	25		32	36	40		50	63	80				
3200			12.5	16	22	32		40	45	50		63	80	100				
4000			16	20	28	40		50	56	63		80	100	125				
5000			20	25	36	50		63	71	80		100	125	160				
6300			25	32	45	63		80	90	100		125	160	200				
8000			32	40	56	80		100	110	125		160	200	250				
10000			40	50	71	100		125	140	160		200	250	320				

Connectors in this catalogue are allocated to fixed rated voltages which apply to the machine building industry. In case of other applications the above chart can be used to determine other rated voltages.

**Degree of protection**

Electrical connector devices have to be protected for safety reasons from outside influences like dust, foreign objects, direct contact, moisture and water. This protection is provided on industrial connectors by the housing latching devices and sealed cable entries. The degree of protection depends on the type of intended use. The standard IEC 60529 and/or DIN EN 60529 has specified the degree of protection and divided them into several classes.

The degree of protection is indicated in the following way: IP 65  
 Code letters (Internat. Protection) \_\_\_\_\_  
 1st charact. numeral (degree of protection against access to hazardous parts and against solid foreign objects)  
 2nd charact. numeral (degree of protection against ingress of water)  
 The following charts 12 an13 give an overview about all protection degrees.

Chart 12			Chart 13		
1st charact. numeral	Brief description	Definition	2nd charact. numeral	Brief description	Definition
0	Non-protected	–	0	Non-protected	–
1	Protected against access to hazardous parts with the back of a hand. Protected against solid foreign objects of $\geq 50\text{mm } \varnothing$ .	The probe, sphere of $50\text{mm } \varnothing$ , shall not fully penetrate and shall have adequate clearance from hazardous parts.	1	Protected against vertically falling water drops	Vertically falling drops shall have no harmful effects.
2	Protected against access to hazardous parts with a finger. Protected against solid foreign objects of $\geq 12,5\text{mm } \varnothing$ .	The jointed test finger of $12\text{mm } \varnothing$ , $80\text{mm}$ length, shall have adequate clearance from hazardous parts. The probe, sphere of $12,5\text{mm } \varnothing$ , shall not fully penetrate.	2	Protected against vertically falling water drops when enclosure tilted up to $15^\circ$	Vertically falling drops shall have no harmful effects when the enclosure is tilted at any angle up to $15^\circ$ .
3	Protected against access to hazardous parts with a tool. Protected against solid foreign objects of $\geq 2,5\text{mm } \varnothing$ .	The probe of $2,5\text{mm } \varnothing$ shall not penetrate at all.	3	Protected against spraying water	Water sprayed at any angle up to $60^\circ$ shall have no harmful effects.
4	Protected against access to hazardous parts with a wire. Protected against solid foreign objects of $\geq 1\text{mm } \varnothing$ .	The probe of $1\text{mm } \varnothing$ shall not penetrate at all.	4	Protected against splashing water	Water splashed against the enclosure from any direction shall have no harmful effects.
5	Protected against access to hazardous parts with a wire. Dust-protected.	The probe of $1\text{mm } \varnothing$ shall not penetrate. Intrusion of dust is not totally prevented, but dust shall not penetrate in a quantity to interfere with satisfactory operation of the device or to impair safety.	5	Protected against water jets	Water projected in jets against the enclosure from any direction shall have no harmful effects.
6	Protected against access to hazardous parts with a wire. Dust-tight.	The probe of $1\text{mm } \varnothing$ shall not penetrate. No intrusion of dust.	6	Protected against powerful water jets	Water projected in powerful jets against the enclosure from any direction shall have no harmful effects.
			7	Protected against the effects of temporary immersion in water	Intrusion of water in quantities causing harmful effects shall not be possible when the enclosure is temporarily immersed in water for 30 min. in 1m depth.
			8	Protected against the effects of continuous immersion in water	Intrusion of water in quantities causing harmful effects shall not be possible when the enclosure is continuously immersed in water under conditions which shall be agreed between manufacturer and user but which are more severe than for numeral 7.
			9K <sup>1)</sup>	Protected against water during high pressure/steam jet cleaning	Water projected in powerful jets with high pressure and heat against the enclosure from any direction shall have no harmful effects.

**Cable**

For the termination of all Amphenol-industrial connectors we recommend the use of commercially available high flexible cable acc. to VDE or other local specifications. Our connectors are designed to fit these cables especially as far as number of conductors and cable diameters are concerned.

When selecting cables care must be taken that the cables do not affect (solvent) the connector or preserve an existing fire resistance.

**Sealing**

The sealing of the cable entries of all Amphenol-industrial connectors is with gland bushings. All sealings are made from Neoprene which has a good resistance against grease, oil and gasoline.

**Selection of gland bushings**

Beside glands with a fixed inside diameter which equals the number, there are also glands with variable inside diameters available (so-called onion glands). The inside diameter of these glands can be adjusted to the outside cable diameter by cutting out the smaller rings.

The selection of the appropriate gland bushing depends on the cable diameter (cable composition) can be made using the following diagram 5 (see page XXX).

**Diagram 5**

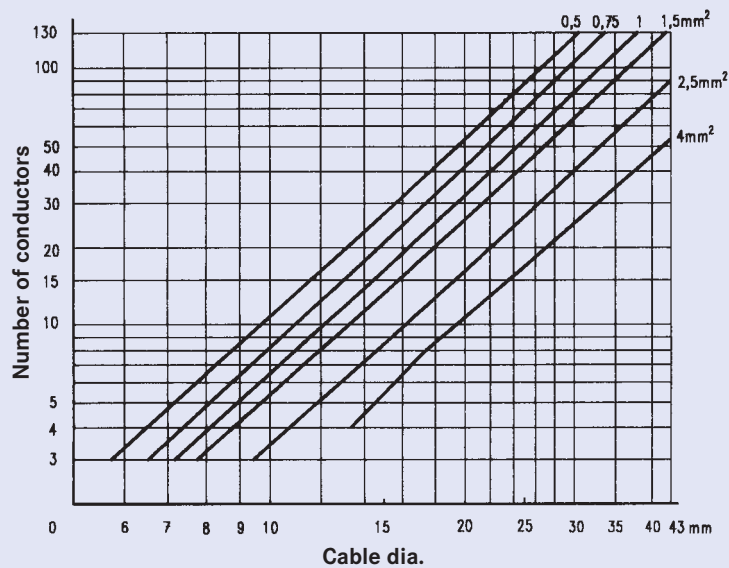

<p><b>American Wire Gauge (AWG)</b></p> <p>System of numerical designations for wire sizes, based on specified ranges of cross-sectional areas.</p> <p>Starts with 4/0 (000) at the largest size, going to 3/0, 2/0, 1/0, 1, 2, and up to 40 and beyond for the smallest size. A step of one AWG number corresponds to a reduction of cross-sectional area of appr. 20 %.</p>	<p><b>Contact</b></p> <p>The conductive element in a connector which mates with a corresponding element to provide an electrical path.</p>
<p><b>Attenuation</b></p> <p>A reduction of power. Occurs naturally when waves travel through lines, wave guides, or media such as air or water. Is produced additionally by imperfections in electrical or optical connections (attenuation in fibre optics), e. g. contact resistance, mismatch, etc.</p>	<p><b>Contact resistance</b></p> <p>The electrical resistance of a mated set of contacts under specified conditions. Tested according to tests 2a, 2b, 2c, of IEC 60 512 -2/ DIN EN 60 512-2.</p>
<p><b>Bulkhead connector</b></p> <p>Connector designed to be inserted into a panel cutout from the rear of the panel, thus forming part of the barrier between two spaces. Back-mounted.</p>	<p><b>Contact size</b></p> <p>The designation used to differentiate one contact from another. It may be denoted by one of the following numbering systems:</p> <ul style="list-style-type: none"> <li>• numbering system: assigned numbers used to denote the size of the contact and its related conductor accommodation (e. g. in AWG units),</li> <li>• current rating system: the related current-carrying capacity is used to denote the size of the contact,</li> <li>• cross-sectional area system: reference is made to the cross-sectional area of the maximum conductor accommodation to denote the size of the contact, e. g. in mm<sup>2</sup>.</li> </ul>
<p><b>Clearance</b></p> <p>The shortest distance in air between two conductive parts, see IEC 60664.</p>	<p><b>Creepage distance</b></p> <p>The shortest distance along the surface of the insulating material between two conductive parts. The longer the distance, the less the risk of arc damage or tracking. Minimum creepage distances are specified according to the rated voltage and the applicable pollution degree and Comparative Tracking Index.</p>
<p><b>Climatic stability</b></p> <p>General term describing the behavior of components under various climatic conditions, e. g. high and low temperatures, tropical climate, high humidity, moist heat, fungus, atmospheric conditions (industrial atmosphere), reduced air pressure, etc. Climatic conditions for test purposes are explained in IEC 60068, DIN 46 040.</p>	<p><b>Crimped connection</b></p> <p>A solderless connection made by crimping. IEC 60352-2 / DIN IEC 60352 Part 2.</p>
<p><b>Connector</b></p> <p>A component which terminates conductors for the purpose of providing connection and disconnection to a suitable mating component which shall not be engaged or disengaged when live. Depending on the fastening to a cabinet, panel, rack etc. or a cable, they are classified as fixed or free connectors. A connector comprises one or more contacts and a housing which may have a separate connector insert and a separate outer housing or shell.</p>	<p><b>Derating curve</b></p> <p>The method for determining derating is specified in IEC 60 512-3. Here the combination of ambient temperature (Tu) and the current (I) leading to the same maximum allowable temperature (Tb) at the hottest point of the connector are plotted.</p>
<p><b>Connector housing</b></p> <p>The part of a connector into which the insert and the contacts are assembled. It may function as part of the locking mechanism.</p>	<p><b>DIN</b></p> <p>Deutsches Institut für Normung. A German standards organization.</p>
<p><b>Connector insert</b></p> <p>An insulating element designed to support and position contacts in a connector housing.</p>	<p><b>Electromagnetic interference (EMI)</b></p> <p>General term describing the undesirable effects of the immission or emission of radio frequency fields.</p> <p>In connectors electromagnetic interference is prevented by shielding. Shielded connectors normally provide means to connect the screens of attached cables.</p>
<p><b>Connector life</b></p> <p>The number of mating cycles prior to abrasion of the conductive contact surface and which does not result in a significant rise of the contact resistance. Tests according to test 9a of ICE 60512-5 / DIN EN 60512 Part 5.</p>	<p><b>Funnel entry (restricted entry C146 D series)</b></p> <p>Flared or widened entrance to a conductor barrel permitting easier insertion of the conductor.</p>

<p><b>Insertion or withdrawal force</b></p> <p>The force required to fully insert or withdraw a set of mated connectors without the effect of coupling, locking or similar devices. The insertion force is usually greater than the withdrawal force.</p>	<p><b>Material group</b></p> <p>Classification of insulation materials according to their CTI values (CTI = Comparative Tracking Index)</p>
<p><b>Insulation grip</b></p> <p>The area of a crimp contact that has been reshaped around the insulation of the conductor by compression during the crimping operation.</p>	<p><b>Overvoltage category</b></p> <p>A numeral defining a transient overvoltage condition. Overvoltage categories I, II, III and IV are used.</p>
<p><b>Insulation resistance</b></p> <p>The resistance of the insulation between two conductive elements, in particular, the resistance between two contacts or between a contact and a metallic housing or shield. Tested according to test 3a of IEC 60512-2 / DIN IEC 60512 Part 2.</p>	<p><b>Connector with braking capacity (CBC)</b></p> <p>A component which may be engaged or disengaged in normal use, when live or under load. Note: In the sense of this document the term - live- is used if contacts are under voltage not necessarily with a current flowing across the contacts. The term - load - is used if a current is flowing across the contacts.</p>
<p><b>Intermateable</b></p> <p>Two connectors are intermateable when they are capable of being connected electrically and mechanically but without regard to their performance and intermountability.</p>	<p><b>Rated current</b></p> <p>A current value assigned by the manufacturer which the connector or PSD can carry continuously (without interruption) and simultaneously through all its contacts wired with the largest conductor preferably at an ambient temperature of 40 °C without the upper temperature being exceeded.</p>
<p><b>Locator</b></p> <p>In a crimping tool the device used for positioning a crimp contact or terminal end.</p>	<p><b>Shield, shielding</b></p> <p>Shielding of internal or external electric fields by means of a plane with a uniform electric potential, formed by metal shells or metallic layers on the inside or outside of plastic shells. The shield is normally connected to the shielding braid of the cable and/or chassis ground.</p>
<p><b>Locking lever</b></p> <p>A mechanical locking device operated by actuating a lever, designed to hold two mated connectors together. Typically the lever can only be fully locked if the two connectors are correctly mated.</p>	<p><b>Terminal block</b></p> <p>An assembly of terminals in a housing or body of insulating material to facilitate interconnection between multiple conductors. Also called terminal strip or barrier blocks if the terminals are separated by an insulation barrier.</p>
<p><b>Mating cycle</b></p> <p>One mating cycle comprises one insertion and one withdrawal operation. Term used in the definition of connector life.</p>	<p><b>Wire range</b></p> <p>The range of wire cross sections which is compatible with the dimensions the terminals of the contact (wire barrel). The wire range is expressed in mm<sup>2</sup> or in AWG numbers.</p>



Stamped crimp contacts series C146, stripping length						
Termination crimp [mm <sup>2</sup> ]	Wire gauge		Insulation diameter of the wire [mm]	Min. stripping length [mm]	Contact Part Number	Series
	mm <sup>2</sup>	AWG				
0.09 - 0.25	0.09 - 0.25	28 - 24	0.7 - 1.6	2.3 + 0.4	N01 010 0130 (2) N02 010 0130 (2)	heavy   mate® M heavy   mate® M
0.14 - 0.5	0.14	26	1.0 - 2.0	3.0 + 0.5	N01 016 0003 N02 016 0003	heavy   mate® D/M
	0.25	24-22				heavy   mate® D/M
	0.5	20				
0.25 - 0.5	0.25	24-22	1.6 - 2.0	2.3 + 0.4	N01 010 0131 (2) N02 010 0131 (2)	heavy   mate® M
	0.5	20				heavy   mate® M
0.5 - 1.5	0.5	20	1.8 - 2.8	3.5 + 1.0	N01 016 0002 N02 016 0002 N01 016 0015 N02 016 0015 N01 025 0001 N02 025 0001 N01 025 0007	heavy   mate® D/M
	0.75	20 - 18				heavy   mate® D/M
	1.0	18 - 16				heavy   mate® D
	1.5	16 - 15				heavy   mate® D
1.5 - 2.5			2.5 - 3.5	3.5 + 1.0	N01 016 0005 N02 016 0005 N01 016 0016 N02 016 0016 N01 025 0010 N02 025 0010 N01 025 0008	heavy   mate® E/M
	1.5	16 - 15				heavy   mate® E/M/S
	2.5	14				heavy   mate® S
						heavy   mate® D/M
						heavy   mate® D/M
						heavy   mate® D
2.5 - 4.0	2.5	14	3.3 - 4.2	3.5 + 1.0	N01 025 0043 N02 025 0043	heavy   mate® E/M
	4.0	12				heavy   mate® E/M/S
						heavy   mate® S

## heavy | mate<sup>®</sup> Information Stripping length

Turned crimp contacts series heavy   mate <sup>®</sup> , stripping length						
Termination crimp [mm <sup>2</sup> ]	Min. stripping length + Tolerance[mm]	Contact Part Number	Series	Min. stripping length + Tolerance[mm]	Contact Part Number	Series
1,6 (Contact without clip)			2,5 (Contact with clip)			
0.14 - 0.37	8 + 1	N01 016 0024 N02 016 0024	heavy   mate <sup>®</sup> D/DD/M			heavy   mate <sup>®</sup> M
0.5	8 + 1	N01 016 0025 N02 016 0025	heavy   mate <sup>®</sup> D/DD/M	7 + 1	N01 025 0029 N02 025 0029	heavy   mate <sup>®</sup> M
0.75 - 1.0	8 + 1	N01 016 0026 N02 016 0026	heavy   mate <sup>®</sup> D/DD/M	7 + 1	N01 025 0030 N02 025 0030	heavy   mate <sup>®</sup> M
1.5	8 + 1	N01 016 0027 N02 016 0027	heavy   mate <sup>®</sup> D/DD/M	7 + 1	N01 025 0031 N02 025 0031	heavy   mate <sup>®</sup> M
2.5	6 + 1	N01 016 0028 N02 016 0028	heavy   mate <sup>®</sup> D/DD/M	7 + 1	N01 025 0032 N02 025 0032	heavy   mate <sup>®</sup> M
4.0				7 + 1	N01 025 0033 N02 025 0033	heavy   mate <sup>®</sup> M
2,5 (Contact without clip)			3,6 (Contact with clip)			
0.5	7 + 1	N01 025 0035 N02 025 0035	heavy   mate <sup>®</sup> E/EE			
0.75 - 1.0	7 + 1	N01 025 0036 N02 025 0036	heavy   mate <sup>®</sup> E/EE			
1.5	7 + 1	N01 025 0037 N02 025 0037	heavy   mate <sup>®</sup> E/EE	10 + 1	N01 036 0004 N02 036 0004	heavy   mate <sup>®</sup> M
2.5	7 + 1	N01 025 0038 N02 025 0038	heavy   mate <sup>®</sup> E/EE	10 + 1	N01 036 0005 N02 036 0005	heavy   mate <sup>®</sup> M
4.0	7 + 1	N01 025 0039 N02 025 0039	heavy   mate <sup>®</sup> E/EE	10 + 1	N01 036 0001 N02 036 0001	heavy   mate <sup>®</sup> M
6.0				10 + 1	N01 036 0002 N02 036 0002	heavy   mate <sup>®</sup> M
10.0				10 + 1	N01 036 0003 N02 036 0003	heavy   mate <sup>®</sup> M

Time saving through the introduction of stamped contacts

Wiring costs of different contacts



Break Even at about 60.000 contacts per year

General conditions	
Maturity (Depreciation)	5 years
Interest	8 %
Maintenance	5 %
Hourly wages	20 €

Non binding declarations are based on experienced values.

# heavy|mate® Summary of Part Numbers

Part Number	Page	Part Number	Page	Part Number	Page	Part Number	Page
17D 438 SP	145, 154	C146 10A024 400 1	54	C146 10B016 002 3	105	C146 10F024 003 1	190
17 DM 537 401	146, 147, 234	C146 10A024 500 1	55, 56	C146 10B016 002 4	20, 21	C146 10F025 000 2	170
17 DM 537 405	146, 147, 234	C146 10A024 505 1	56	C146 10B016 004 4	21	C146 10F025 003 2	170
17 DM 537 421	146, 147, 234	C146 10A024 810 1	73	C146 10B016 102 1	52	C146 10F032 000 4	173
17 DM 537 425	146, 147, 234	C146 10A025 000 2	29, 31	C146 10B016 102 3	105, 106	C146 10F048 001 1	196
C146 10A003 002 4	18	C146 10A025 005 2	31	C146 10B016 102 4	20, 21	C146 10F048 003 1	196
C146 10A003 102 3	102	C146 10A025 060 2	29	C146 10B016 104 3	106	C146 10N003 500 4	166
C146 10A003 500 15	78, 83	C146 10A025 500 2	29, 31	C146 10B016 104 4	21	C146 10N006 602 2	175
C146 10A004 002 4	18	C146 10A025 505 2	31	C146 10B016 400 1	52	C146 10N006 603 1	175
C146 10A004 100 13	111	C146 10A032 500 10	66	C146 10B016 500 1	53	C146 10N006 603 2	175
C146 10A005 500 12	159	C146 10A040 000 2	30	C146 10B016 810 1	73	C146 10N006 606 2	175
C146 10A006 000 1	48	C146 10A040 060 2	30	C146 10B017 500 15	79, 91	C146 10N006 607 1	175
C146 10A006 002 1	48	C146 10A040 500 2	30	C146 10B018 500 10	65	C146 10N006 607 2	175
C146 10A006 100 13	111	C146 10A042 000 9	41	C146 10B020 500 15	79, 93	C146 10N006 802 2	175
C146 10A006 102 1	48	C146 10A042 500 13	113	C146 10B024 000 1	54, 56	C146 10N006 803 1	175
C146 10A006 102 3	103	C146 10A046 500 10	66	C146 10B024 000 9	41	C146 10N006 806 1	175
C146 10A006 102 5	97	C146 10A064 000 2	32, 33	C146 10B024 002 1	54, 56	C146 10N006 806 2	175
C146 10A006 400 1	48	C146 10A064 005 2	33	C146 10B024 005 1	56	C146 10N006 807 1	175
C146 10A006 500 1	49	C146 10A064 060 2	32	C146 10B024 102 1	54, 56	C146 10N006 807 2	175
C146 10A006 500 15	78, 85	C146 10A064 500 2	32, 33	C146 10B024 400 1	54	C146 10N010 500 1	177
C146 10A006 810 1	72	C146 10A064 505 2	33	C146 10B024 500 1	55, 56	C146 10N010 500 2	177
C146 10A007 000 2	27	C146 10A072 000 9	41	C146 10B024 505 1	56	C146 10N010 501 1	177
C146 10A007 500 2	27	C146 10A108 000 9	42	C146 10B024 810 1	73	C146 10N010 501 2	177
C146 10A007 500 12	161	C146 10A108 005 9	42	C146 10B025 000 2	29, 31	C146 10N010 508 2	181
C146 10A008 000 2	27	C146 10B003 002 4	18	C146 10B025 005 2	31	C146 10N010 509 1	181
C146 10A008 500 2	27	C146 10B003 102 3	102	C146 10B025 060 2	29	C146 10N010 600 2	177
C146 10A008 500 15	78, 87	C146 10B003 500 15	78, 83	C146 10B025 500 2	29, 31	C146 10N010 601 1	177
C146 10A010 000 1	50	C146 10B004 002 4	18	C146 10B025 505 2	31	C146 10N010 601 2	177
C146 10A010 002 1	50	C146 10B004 100 13	111	C146 10B032 500 10	66	C146 10N010 603 1	179
C146 10A010 002 4	19	C146 10B005 500 12	159	C146 10B040 000 2	30	C146 10N010 603 2	179
C146 10A010 102 1	50	C146 10B006 000 1	48	C146 10B040 060 2	30	C146 10N010 604 2	181
C146 10A010 102 3	104	C146 10B006 002 1	48	C146 10B040 500 2	30	C146 10N010 605 1	181
C146 10A010 102 4	19	C146 10B006 100 13	111	C146 10B042 000 9	41	C146 10N010 606 2	179
C146 10A010 400 1	50	C146 10B006 102 1	48	C146 10B042 500 13	113	C146 10N010 607 1	179
C146 10A010 500 1	51	C146 10B006 102 3	103	C146 10B046 500 10	66	C146 10N010 607 2	179
C146 10A010 500 10	65	C146 10B006 102 5	97	C146 10B064 000 2	32, 33	C146 10N010 609 1	181
C146 10A010 810 1	72	C146 10B006 400 1	48	C146 10B064 005 2	33	C146 10N010 609 2	181
C146 10A012 500 15	79, 89	C146 10B006 500 1	49	C146 10B064 060 2	32	C146 10N010 802 2	179
C146 10A015 000 2	28	C146 10B006 500 15	78, 85	C146 10B064 500 2	32, 33	C146 10N010 803 1	179
C146 10A015 060 2	28	C146 10B006 810 1	72	C146 10B064 505 2	33	C146 10N010 803 2	179
C146 10A015 500 2	28	C146 10B007 000 2	27	C146 10B072 000 9	41	C146 10N010 804 2	181
C146 10A016 000 1	52	C146 10B007 500 2	27	C146 10B108 000 9	42	C146 10N010 805 1	181
C146 10A016 002 1	52	C146 10B007 500 12	161	C146 10B108 005 9	42	C146 10N010 806 2	179
C146 10A016 002 3	105	C146 10B008 000 2	27	C146 10F003 000 4	166	C146 10N010 807 1	179
C146 10A016 002 4	20, 21	C146 10B008 500 2	27	C146 10F003 004 4	166	C146 10N010 807 2	179
C146 10A016 004 4	21	C146 10B008 500 15	78, 87	C146 10F006 000 1	174	C146 10N015 500 2	169
C146 10A016 102 1	52	C146 10B010 000 1	50	C146 10F006 003 1	174	C146 10N015 600 2	169
C146 10A016 102 3	105, 106	C146 10B010 002 1	50	C146 10F010 000 1	176	C146 10N015 606 2	169
C146 10A016 102 4	20, 21	C146 10B010 002 4	19	C146 10F010 001 1	178	C146 10N015 607 2	169
C146 10A016 104 3	106	C146 10B010 102 1	50	C146 10F010 002 1	180	C146 10N015 806 2	169
C146 10A016 104 4	21	C146 10B010 102 3	104	C146 10F010 003 1	178	C146 10N016 500 1	183
C146 10A016 400 1	52	C146 10B010 102 4	19	C146 10F010 090 1	176	C146 10N016 500 2	183
C146 10A016 500 1	53	C146 10B010 400 1	50	C146 10F015 000 2	168	C146 10N016 508 1	187
C146 10A016 810 1	73	C146 10B010 500 1	51	C146 10F015 003 2	168	C146 10N016 508 2	187
C146 10A017 500 15	79, 91	C146 10B010 500 10	65	C146 10F016 000 1	183	C146 10N016 600 1	183
C146 10A018 500 10	65	C146 10B010 810 1	72	C146 10F016 001 1	184	C146 10N016 600 2	183
C146 10A020 500 15	79, 93	C146 10B012 500 15	79, 89	C146 10F016 002 1	186	C146 10N016 601 2	183
C146 10A024 000 1	54, 56	C146 10B015 000 2	28	C146 10F016 003 1	184	C146 10N016 602 1	185
C146 10A024 000 9	41	C146 10B015 060 2	28	C146 10F024 000 1	189	C146 10N016 602 2	185
C146 10A024 002 1	54, 56	C146 10B015 500 2	28	C146 10F024 000 3	197	C146 10N016 603 2	185
C146 10A024 005 1	56	C146 10B016 000 1	52	C146 10F024 001 1	190	C146 10N016 604 1	187
C146 10A024 102 1	54, 56	C146 10B016 002 1	52	C146 10F024 002 1	192	C146 10N016 604 2	187

# heavy|mate® Summary of Part Numbers

Part Number	Page	Part Number	Page	Part Number	Page	Part Number	Page
C146 10N016 606 1	185	C146 10R024 650 3	197	C146 11R016 650 8	214	C146 21R015 550 2	168
C146 10N016 606 2	185	C146 10R024 802 3	197	C146 11R024 500 1	215	C146 21R015 600 2	168
C146 10N016 607 2	185	C146 10R024 852 3	197	C146 11R024 500 8	215	C146 21R015 650 2	168
C146 10N016 608 1	187	C146 10R024 903 8	194	C146 11R024 501 8	215	C146 21R015 804 2	168
C146 10N016 608 2	187	C146 10R024 908 8	194	C146 11R024 550 1	215	C146 21R015 854 2	168
C146 10N016 802 1	185	C146 10S006 000 15	80	C146 11R024 550 8	215	C146 21R016 500 1	183
C146 10N016 802 2	185	C146 10S010 000 15	80	C146 11R024 600 1	215	C146 21R016 500 4	170
C146 10N016 804 1	187	C146 10S016 000 15	80	C146 11R024 600 8	215	C146 21R016 500 8	183
C146 10N016 804 2	187	C146 10S024 000 15	81	C146 11R024 601 8	215	C146 21R016 501 8	183
C146 10N016 806 1	185	C146 10Z000 002 8	155	C146 11R024 650 1	215	C146 21R016 502 1	186
C146 10N016 806 2	185	C146 10Z001 001 8	155	C146 11R024 650 8	215	C146 21R016 502 8	186
C146 10N024 500 1	189	C146 10Z002 001 8	155	C146 21R006 506 1	174	C146 21R016 503 8	186
C146 10N024 500 2	189	C146 10Z003 100 4	166	C146 21R006 506 8	174	C146 21R016 506 1	184
C146 10N024 500 3	197	C146 10Z006 100 1	175	C146 21R006 507 1	174	C146 21R016 506 8	184
C146 10N024 508 1	193	C146 10Z006 200 1	175	C146 21R006 556 8	174	C146 21R016 507 8	184
C146 10N024 508 2	193	C146 10Z010 100 1	182	C146 21R006 606 1	174	C146 21R016 550 1	183
C146 10N024 600 1	189	C146 10Z010 200 1	182	C146 21R006 606 8	174	C146 21R016 550 4	170
C146 10N024 600 2	189	C146 10Z015 100 2	169	C146 21R006 656 1	174	C146 21R016 552 1	186
C146 10N024 600 3	197	C146 10Z016 100 1	188	C146 21R006 656 8	174	C146 21R016 556 1	184
C146 10N024 601 2	189	C146 10Z016 200 1	188	C146 21R006 804 1	174	C146 21R016 600 1	183
C146 10N024 602 1	191	C146 10Z024 100 1	194	C146 21R006 854 8	174	C146 21R016 600 4	170
C146 10N024 602 2	191	C146 10Z024 200 1	194	C146 21R010 500 1	176	C146 21R016 600 8	183
C146 10N024 604 1	193	C146 10Z025 100 2	171	C146 21R010 500 4	168	C146 21R016 601 8	183
C146 10N024 604 2	193	C146 11F006 001 8	212	C146 21R010 500 8	176	C146 21R016 602 1	186
C146 10N024 605 2	193	C146 11F006 901 8	212	C146 21R010 502 8	180	C146 21R016 602 8	186
C146 10N024 606 1	191	C146 11F006 902 8	212	C146 21R010 506 1	178	C146 21R016 603 8	186
C146 10N024 606 2	191	C146 11F010 000 8	213	C146 21R010 506 8	178	C146 21R016 606 1	184
C146 10N024 607 2	191	C146 11F010 901 8	213	C146 21R010 550 1	176	C146 21R016 606 8	184
C146 10N024 608 1	193	C146 11F010 902 8	213	C146 21R010 550 4	168	C146 21R016 607 8	184
C146 10N024 608 2	193	C146 11F016 000 8	214	C146 21R010 550 8	176	C146 21R016 650 1	183
C146 10N024 802 1	191	C146 11F016 901 8	214	C146 21R010 552 1	180	C146 21R016 650 4	170
C146 10N024 802 2	191	C146 11F016 902 8	214	C146 21R010 552 8	180	C146 21R016 652 1	186
C146 10N024 804 1	193	C146 11F024 000 8	215	C146 21R010 556 1	178	C146 21R016 656 1	184
C146 10N024 804 2	193	C146 11F024 901 8	215	C146 21R010 556 8	178	C146 21R016 802 1	183
C146 10N024 806 1	191	C146 11F024 902 8	215	C146 21R010 600 1	176	C146 21R016 802 8	183
C146 10N024 806 2	191	C146 11R006 506 1	212	C146 21R010 600 4	168	C146 21R016 803 8	183
C146 10N024 808 1	193	C146 11R006 506 8	212	C146 21R010 600 8	176	C146 21R016 804 1	184
C146 10N025 500 2	171	C146 11R006 507 1	212	C146 21R010 602 8	180	C146 21R016 804 4	170
C146 10N025 600 2	171	C146 11R006 556 1	212	C146 21R010 606 1	178	C146 21R016 804 8	184
C146 10N025 601 2	171	C146 11R006 556 8	212	C146 21R010 606 8	178	C146 21R016 805 8	184
C146 10N025 606 2	171	C146 11R006 606 1	212	C146 21R010 607 1	178	C146 21R016 852 1	183
C146 10N025 607 2	171	C146 11R006 606 8	212	C146 21R010 607 8	178	C146 21R016 854 1	184
C146 10N025 806 2	171	C146 11R006 607 1	212	C146 21R010 650 1	176	C146 21R016 854 4	170
C146 10N032 500 4	173	C146 11R006 656 8	212	C146 21R010 650 4	168	C146 21R024 500 1	189
C146 10N032 550 4	173	C146 11R010 500 1	213	C146 21R010 650 8	176	C146 21R024 500 8	189
C146 10N032 600 4	173	C146 11R010 500 8	213	C146 21R010 652 1	180	C146 21R024 501 8	189
C146 10N032 650 4	173	C146 11R010 550 1	213	C146 21R010 652 8	180	C146 21R024 502 1	192
C146 10N048 803 1	196	C146 11R010 550 8	213	C146 21R010 656 1	178	C146 21R024 502 8	192
C146 10N048 807 1	196	C146 11R010 600 1	213	C146 21R010 656 8	178	C146 21R024 503 8	192
C146 10P006 000 15	80	C146 11R010 600 8	213	C146 21R010 802 1	176	C146 21R024 506 1	190
C146 10P010 000 15	80	C146 11R010 601 1	213	C146 21R010 802 8	176	C146 21R024 506 8	190
C146 10P016 000 15	80	C146 11R010 601 8	213	C146 21R010 804 1	178	C146 21R024 507 8	190
C146 10P024 000 15	81	C146 11R010 650 1	213	C146 21R010 804 4	168	C146 21R024 550 1	189
C146 10R003 500 4	166	C146 11R010 650 8	213	C146 21R010 804 8	178	C146 21R024 552 1	192
C146 10R003 600 4	166	C146 11R016 500 1	214	C146 21R010 805 1	178	C146 21R024 556 1	190
C146 10R003 804 4	166	C146 11R016 500 8	214	C146 21R010 805 8	178	C146 21R024 600 1	189
C146 10R010 902 8	182	C146 11R016 501 8	214	C146 21R010 852 1	176	C146 21R024 600 8	189
C146 10R016 902 8	188	C146 11R016 550 8	214	C146 21R010 852 8	176	C146 21R024 601 8	189
C146 10R016 910 8	188	C146 11R016 600 1	214	C146 21R010 854 1	178	C146 21R024 602 1	192
C146 10R024 500 3	197	C146 11R016 600 8	214	C146 21R010 854 4	168	C146 21R024 602 8	192
C146 10R024 550 3	197	C146 11R016 601 8	214	C146 21R010 854 8	178	C146 21R024 603 8	192
C146 10R024 600 3	197	C146 11R016 650 1	214	C146 21R015 500 2	168	C146 21R024 606 1	190

# heavy|mate® Summary of Part Numbers

Part Number	Page	Part Number	Page	Part Number	Page	Part Number	Page
C146 21R024 606 8	190	C146 67R010 500 1	201	C146 H01 034 G8	151, 122	N02 060 6118 001	129
C146 21R024 607 8	190	C146 67R010 600 1	201	C146 H01 044 G8	151, 122	N02 100 6121 002	127
C146 21R024 650 1	189	C146 67R016 500 8	202	C146 H02 034 G8	151, 122	N02 100 6122 002	127
C146 21R024 652 1	192	C146 67R016 600 8	202	C146 H02 044 G8	151, 122	N02 100 6123 002	127
C146 21R024 656 1	190	C146 67R024 501 8	203	C146 N32 009 G1	228	N06 080 0003 1	228
C146 21R024 802 1	189	C146 67R024 601 8	203	C146 N32 015 G1	228	N06 080 0003 2	228
C146 21R024 802 8	189	C146 68F006 001 1	206	C146 N32 015 G2	228	N06 080 0003 3	228
C146 21R024 803 8	189	C146 68F010 001 1	207	C146 N32 025 G1	228	N06 080 0003 4	228
C146 21R024 804 1	190	C146 68F016 001 1	208	C146 N32 025 G2	228	N07 045 0001 L	228
C146 21R024 804 8	190	C146 68F024 001 1	209	C146 N32 037 G1	228	N15 006 000 9Z	133, 135
C146 21R024 805 8	190	C146 68N006 500 2	206	C146 N32 050 G1	228	N15 010 000 7Z	133, 135
C146 21R024 852 1	189	C146 68N010 500 2	207	C146 N33 009 G1	228	N15 043 0003 003	129, 131
C146 21R024 854 1	190	C146 68N016 501 2	208	C146 N33 015 G1	228	N16 025 0112 5X	217
C146 21R025 500 2	170	C146 68N024 501 2	209	C146 N33 025 G1	228	N16 032 0112 5X	217
C146 21R025 550 2	170	C146 68R006 500 8	206	C146 N33 037 G1	228	N16 040 0112 5X	217
C146 21R025 600 2	170	C146 68R006 600 8	206	C146 N33 050 G1	228	N17 045 000 1	159
C146 21R025 650 2	170	C146 68R010 500 8	207	C146 P06 001 G8	124	N17 059 000 1	161
C146 21R025 804 2	170	C146 68R010 600 8	207	C146 P06 002 G8	124	N17 059 000 2	161
C146 21R025 854 2	170	C146 68R016 501 8	208	C146 P10 001 G8	124	TA 0000	36, 60, 61, 67,
C146 21R032 500 4	172	C146 68R016 601 8	208	C146 P10 002 G8	124		85, 87, 93, 133, 135,
C146 21R032 502 4	172	C146 68R024 501 8	209	C146 P16 001 G8	124		137, 139, 141, 143, 147
C146 21R032 550 4	172	C146 68R024 601 8	209	C146 P16 002 G8	124	TA 0000 121	137
C146 21R032 552 4	172	C146 A00 001 E8	155	C146 P24 001 G8	125	TA 0000 124	61, 67, 85, 87,
C146 21R032 600 4	172	C146 A01 001 E8	118, 127	C146 P24 002 G8	125		93, 133, 135, 139
C146 21R032 602 4	172	C146 A02 001 E8	118, 129	C146 P24 101 G8	125	TA 0000 141	36, 60, 137, 141
C146 21R032 650 4	172	C146 A02 801 E8	118, 131	C146 P24 102 G8	125	TA 0000 144	61, 67, 85, 87,
C146 21R032 652 4	172	C146 A03 001 E8	119, 135	C146 S06 001 G8	124		93, 133, 135, 139
C146 21R032 802 4	172	C146 A03 501 E8	121, 147	C146 S06 002 G8	124	TA 0000 163	36, 60, 137, 141
C146 21R032 852 4	172	C146 A03 801 E8	119, 133	C146 S10 001 G8	124	TA 0000 180	133, 135
C146 21R048 507 1	195	C146 A05 001 E8	120, 139	C146 S10 002 G8	124	TA 0000 184	143, 153
C146 21R048 508 1	195	C146 A05 100 G8	122, 153	C146 S16 001 G8	124	TA 0000 202	36, 141
C146 21R048 607 1	195	C146 A08 102 E8	122, 153	C146 S16 002 G8	124	TA 0000 401	147
C146 21R048 608 1	195	C146 A10 001 E8	120, 143	C146 S24 001 G8	125	TA 0000 402	147
C146 30F003 000 4	167	C146 A20 001 G8	121, 145	C146 S24 002 G8	125	TA 0000 oder TA 0500	153
C146 30F003 004 4	167	C146 B00 001 E8	155	C146 S24 101 G8	125	TA 0001 146 000 1	36, 141
C146 30F006 003 1	174	C146 B01 004 E1	118	C146 S24 102 G8	125	TA 0002 146 000 1	36, 141
C146 30F010 003 1	178	C146 B01 004 E8	127	FG 0200 146 1	60, 137, 154	TA 0003 146 000 1	137
C146 30F016 003 1	184	C146 B02 001 E8	118, 129	FG 0300 146 1	36, 37, 43,	TA 0004 146 000 1	60, 137
C146 30F024 003 1	190	C146 B02 801 E8	118, 131		89, 91, 143, 141, 153, 154	TA 0005 146 000 3	60, 137
C146 30N003 500 4	167	C146 B03 001 E8	119, 135	FG 1000 146	141	TA 0007 146 000 3	36, 141
C146 30R003 500 4	167	C146 B03 501 E8	147	FG 0300 146 3	131, 133,	TA 0010 146 000 1	143, 153
C146 30R003 600 4	167	C146 B03 801 E8	119, 133		135, 147, 154	TA 0010 146 000 2	133, 139
C146 30R003 804 4	167	C146 B05 001 E8	120, 139	FG 0300 146 4	139, 154	TA 0010 146 000 3	139
C146 30Z003 100 4	167	C146 B05 100 G8	122, 153	FG 0300 146 7	61, 67,	TA 0010 146 000 4	133, 135
C146 50F006 000 1	218	C146 B08 102 E8	122, 153		85, 87, 93	TA 0010 146 000 5	135
C146 50F010 000 1	219	C146 B10 001 E8	120, 143	FG 1000 146	131, 133, 135,	TA 0010 146 000 6	61
C146 50F016 000 1	220	C146 B20 001 G8	121		137, 139, 141, 143, 145, 147, 155	TA 0010 146 000 6	67, 85,
C146 50F024 000 1	221	C146 B20 001 G8	145	.N01 016 0002 (1)	34		87, 93
C146 50R006 507 1	218	C146 C04 001 E8	119, 137	.N01 016 0003 (1)	34	TA 0010 146 000 7	61, 67,
C146 50R006 607 1	218	C146 C05 001 E8	119, 137	.N01 016 0005 (1)	34		85, 87, 93
C146 50R010 500 1	219	C146 C05 801 E8	119, 137	N01 016 0040 8	234	TA 0100 146	36, 37, 43,
C146 50R010 600 1	219	C146 C10 001 G8	120, 141	N01 025 0001 (1)	58		89, 91, 141
C146 50R016 500 8	220	C146 D04 001 E8	119, 137	N01 025 0010 (1)	58	TA 0200 146	145
C146 50R016 600 8	220	C146 D05 001 E8	119, 137	N01 060 0004 1	129	TA 0500	36, 61, 67,
C146 50R024 501 8	221	C146 D05 801 E8	119, 137	N01 060 0007 1	129		85, 87, 93
C146 50R024 601 8	221	C146 D10 001 E8	120, 141	N01 060 0008 1	129	TB 0200 146	133, 135
C146 67F006 000 8	200	C146 E12 001 E8	121, 149	N01 100 6001 001	127	TB 0500 146	143
C146 67F010 000 8	201	C146 F12 001 G8	121, 149	N01 100 6002 001	127	TB 0600 146	60, 61, 67,
C146 67F016 000 8	202	C146 G01 014 G8	122, 151	N01 100 6003 001	127		85, 87, 93
C146 67F024 000 8	203	C146 G01 024 G8	151, 122	N02 016 0040 8	234	TE 0500 103	127
C146 67R006 507 1	200	C146 G02 014 G8	151, 122	N02 060 6114 001	129	TE 0500 201	127
C146 67R006 607 1	200	C146 G02 024 G8	151, 122	N02 060 6117 001	129	TE 0500 301	127

# heavy|mate® Summary of Part Numbers

Part Number	Page	Part Number	Page	Part Number	Page	Part Number	Page
TE 0600 022	129	VN01 016 0027 (1)C	37, 43,	VN01 040 0010 1C	83, 113	VN02 025 0037 (1)C	61, 67,
TE 0600 042	129	89, 91, 143, 149, 233		VN01 040 0011 1C	83, 113	85, 87, 93, 159, 233	
TE 0600 062	129	VN01 016 0027 1C	113, 161	VN01 040 0012 1C	83, 113	VN02 025 0037 (2)C	61, 67,
TE 0600 063	131	VN01 016 0027 (2)C	37, 43,	VN01 040 0013 1C	83, 113	85, 87, 93, 159	
TN01 010 0130 (2)	145	89, 91, 143, 149		VN02 010 0130 (2)	145	VN02 025 0038 (1)C	61, 67,
TN01 010 0131 (2)	145	VN01 016 0027 2C	153, 161	VN02 010 0131 (2)	145	85, 87, 93, 159, 233	
TN01 016 0002 (1)	36, 141	VN01 016 0028 (1)C	37, 43,	VN02 016 0002 (1)	36, 141	VN02 025 0038 (2)C	61, 67,
TN01 016 0002 (2)	36, 141	89, 91, 143, 149, 233		VN02 016 0002 (2)	36, 141	85, 87, 93, 159	
TN01 016 0003 (1)	36, 141	VN01 016 0028 1C	113, 161	VN02 016 0003 (1)	36, 141	VN02 025 0039 (1)C	61, 67,
TN01 016 0003 (2)	36, 141	VN01 016 0028 (2)C	37, 43,	VN02 016 0003 (2)	36, 141	85, 87, 93, 159, 233	
TN01 016 0005 (1)	36, 141	89, 91, 143, 149		VN02 016 0005 (1)	36, 141	VN02 025 0039 (2)C	61, 67,
TN01 016 0005 (2)	36, 141	VN01 016 0028 2C	153, 161	VN02 016 0005 (2)	36, 141	85, 87, 93, 159	
TN01 016 0015 (1)	36, 141	VN01 016 0040 (8) X	143	VN02 016 0015 (1)	36	VN02 025 0043 (1)	137
TN01 016 0016 (1)	36, 141	VN01 025 0001 (101)	60, 137	VN02 016 0016 (1)	36	VN02 036 0001 (1)C	133,
TN01 025 0001 (1)	60, 137	VN01 025 0001 (102)	60, 137	VN02 016 0024 (1)C	37, 43,	135, 233	
TN01 025 0001 (2)	137	VN01 025 0010 (101)	60, 137	89, 91, 143, 149, 233		VN02 036 0002 (1)C	133,
TN01 025 0010 (1)	60, 137	VN01 025 0010 (102)	60, 137	VN02 016 0024 1C	113, 161	135, 233	
TN01 025 0010 (2)	137	VN01 025 0029 (1)C	139, 233	VN02 016 0024 (2)C	37, 43,	VN02 036 0003 (1)C	133,
TN01 025 0043 (1)	137	VN01 025 0030 (1)C	139, 233	89, 91, 143, 149		135, 233	
TN02 010 0130 (2)	145	VN01 025 0031 (1)C	139, 233	VN02 016 0024 2C	153, 161	VN02 036 0004 (1)C	133,
TN02 010 0131 (2)	145	VN01 025 0032 (1)C	139, 233	VN02 016 0025 (1)C	37, 43,	135, 233	
TN02 016 0002 (1)	36, 141	VN01 025 0033 (1)C	139, 233	89, 91, 143, 149, 233		VN02 036 0005 (1)C	133,
TN02 016 0002 (2)	36, 141	VN01 025 0035 (1)C	61, 67,	VN02 016 0025 1C	113, 161	135, 233	
TN02 016 0003 (1)	36, 141	85, 87, 93, 233		VN02 016 0025 (2)C	37, 43,	VN02 036 0021 1C	131
TN02 016 0003 (2)	36, 141	VN01 025 0035 1C	159	89, 91, 143, 149		VN02 040 0010 1C	83, 113
TN02 016 0005 (1)	36, 141	VN01 025 0035 (2)C	61, 67,	VN02 016 0025 2C	153, 161	VN02 040 0011 1C	83, 113
TN02 016 0005 (2)	36, 141	85, 87, 93		VN02 016 0026 (1)C	37, 43,	VN02 040 0012 1C	83, 113
TN02 016 0015 (1)	36, 141	VN01 025 0035 2C	159	89, 91, 143, 149, 233		VN02 040 0013 1C	83, 113
TN02 016 0016 (1)	36, 141	VN01 025 0036 (1)C	61, 67,	VN02 016 0026 1C	113, 161	VN03 030 0020	226
TN02 025 0001 (1)	60, 137	85, 87, 93, 233		VN02 016 0026 (2)C	37, 43,	VN03 030 0021	226
TN02 025 0001 (1)	137	VN01 025 0036 1C	159	89, 91, 143, 149		VN03 030 3000 X	226
TN02 025 0001 (2)	137	VN01 025 0036 (2)C	61, 67,	VN02 016 0026 2C	153, 161	VN13 040 0008 (1) X	226
TN02 025 0010 (1)	60, 137	85, 87, 93		VN02 016 0027 (1)C	37, 43,	VN13 040 0009 (1) X	226
TN02 025 0010 (2)	137	VN01 025 0036 2C	159	89, 91, 143, 149, 233		VN16 020 0113 (1) X	225
TN02 025 0043 (1)	137	VN01 025 0037 (1)C	61, 67,	VN02 016 0027 1C	113, 161	VN16 025 0113 (1) X	225
VN01 010 0130 (2)	145	85, 87, 93, 233		VN02 016 0027 (2)C	37, 43,	VN16 032 0113 (1) X	225
VN01 010 0131 (2)	145	VN01 025 0037 1C	159	89, 91, 143, 149		VN16 040 0113 (1) X	225
VN01 016 0002 (1)	36, 141	VN01 025 0037 (2)C	61, 67,	VN02 016 0027 2C	153, 161	VN16 160 0102 V	224
VN01 016 0002 (2)	36, 141	85, 87, 93		VN02 016 0028 (1)C	37, 43,	VN16 160 0126 X	225
VN01 016 0003 (1)	36, 141	VN01 025 0037 2C	159	89, 91, 143, 149, 233		VN16 160 0127 X	225
VN01 016 0003 (2)	36, 141	VN01 025 0038 (1)C	61, 67,	VN02 016 0028 1C	113, 161	VN16 200 0102 V	224
VN01 016 0005 (1)	36, 141	85, 87, 93, 233		VN02 016 0028 (2)C	37, 43,	VN16 200 0103 V	224
VN01 016 0005 (2)	36, 141	VN01 025 0038 1C	61, 67,	89, 91, 143, 149		VN16 200 0114 X	224
VN01 016 0015 (1)	36	85, 87, 93		VN02 016 0028 2C	153, 161	VN16 200 0114 X	224
VN01 016 0016 (1)	36	VN01 025 0038 2C	159	VN02 016 0040 (8) X	143	VN16 200 0126 X	225
VN01 016 0024 (1)C	37, 43,	VN01 025 0039 (1)C	61, 67,	VN02 025 0001 (101)	60, 137	VN16 200 0127 X	225
89, 91, 143, 149, 233		85, 87, 93, 233		VN02 025 0001 (102)	60, 137	VN16 250 0102 V	224
VN01 016 0024 1C	113, 161	VN01 025 0039 1C	159	VN02 025 0010 (101)	60, 137	VN16 250 0103 V	224
VN01 016 0024 (2)C	37, 43,	VN01 025 0039 (2)C	61, 67,	VN02 025 0010 (102)	60, 137	VN16 250 0114 X	224
89, 91, 143, 149		85, 87, 93		VN02 025 0029 (1)C	139, 233	VN16 250 0126 X	225
VN01 016 0024 2C	153, 161	VN01 025 0039 2C	159	VN02 025 0030 (1)C	139, 233	VN16 250 0127 X	225
VN01 016 0025 (1)C	37, 43,	VN01 025 0043 (1)	137	VN02 025 0031 (1)C	139, 233	VN16 320 0102 V	224
89, 91, 143, 149, 233		VN01 036 0001 (1)C	133, 135,	VN02 025 0032 (1)C	139, 233	VN16 320 0103 V	224
VN01 016 0025 1C	113, 161	233		VN02 025 0033 (1)C	139, 233	VN16 320 0114 X	224
VN01 016 0025 (2)C	37, 43,	VN01 036 0002 (1)C	135, 233	VN02 025 0035 (1)C	61, 67,	VN16 320 0126 X	225
89, 91, 143, 149, 153, 161		VN01 036 0003 (1)C	133, 135,	85, 87, 93, 159, 233		VN16 320 0127 X	225
VN01 016 0026 (1)C	37, 43,	233		VN02 025 0035 (2)C	61, 67,	VN16 400 0114 X	224
89, 91, 143, 149, 233		VN01 036 0004 (1)C	133, 135,	85, 87, 93, 159		VN16 400 0126 X	225
VN01 016 0026 1C	113, 161	233		VN02 025 0036 (1)C	61, 67,	VN16 400 0127 X	225
VN01 016 0026 (2)C	37, 43,	VN01 036 0005 (1)C	133, 135,	85, 87, 93, 159, 233		VN16 500 0114 X	224
89, 91, 143, 149		233		VN02 025 0036 (2)C	61, 67,	VN17 050 0004 (1)	226
VN01 016 0026 2C	153, 161	VN01 036 0021 1C	131	85, 87, 93, 159		VN17 050 0004 (101)	226

## heavy|mate<sup>®</sup> Summary of Part Numbers

Part Number	Page
ZN01 010 0130 (2)	145
ZN01 010 0131 (2)	145
ZN01 016 0002 (1)	36, 141
ZN01 016 0002 (2)	36, 141
ZN01 016 0003 (1)	36, 141
ZN01 016 0003 (2)	36, 141
ZN01 016 0005 (1)	36, 141
ZN01 016 0005 (2)	36, 141
ZN01 016 0015 (1)	36, 141
ZN01 016 0016 (1)	36, 141
ZN01 025 0001 (1)	60
ZN01 025 0001 (2)	60
ZN01 025 0010 (1)	60
ZN01 025 0010 (2)	60
ZN02 010 0130 (2)	145
ZN02 010 0131 (2)	145
ZN02 016 0002 (1)	36, 141
ZN02 016 0002 (2)	36, 141
ZN02 016 0003 (1)	36, 141
ZN02 016 0003 (2)	36, 141
ZN02 016 0005 (1)	36, 141
ZN02 016 0005 (2)	36, 141
ZN02 016 0015 (1)	36, 141
ZN02 016 0016 (1)	36, 141
ZN02 025 0001 (1)	60
ZN02 025 0001 (2)	60
ZN02 025 0010 (1)	60
ZN02 025 0010 (2)	60









# International

## Argentina

Amphenol Argentina  
Av. Callao 930  
2nd Floor Office B "Plaza"  
C1023 AAP Buenos Aires  
Phone +54 11 4815 68 86  
www.amphenol.com.ar

## Australia

Amphenol Australia Pty. Ltd.  
2 Fiveways Blvd  
Keysborough  
Victoria 31 73  
Phone +61 3 8796 88 88  
www.amphenol.com.au

## Brazil

Amphenol do Brasil Ltda.  
Rua Diogo Moreira 132, 20th Floor  
CEP 05423-101 Sao Paulo SP  
Phone +55 11 3815 10 03  
www.amphenol.com.br

## China

Amphenol-Tuchel Electronics  
China Branch  
20 Taishan Road  
Changzhou 213022  
Phone +86 0519 511 03 01  
www.amphenol.info

## France

Amphenol Socapex S.A.S.  
948, Promenade de l'Arve, BP 29  
Thyez Cedex, 74311  
Phone +33 4 5089 28 00  
www.amphenol-socapex.com

## Germany

Amphenol-Tuchel Electronics GmbH  
August-Haeusser-Str. 10  
74080 Heilbronn  
Phone +49 7131 929 0  
www.amphenol.de

## India

Amphenol Interconnect India Pvt Ltd  
105, Bhosari Industrial Area  
Pune - 411 026  
Phone +91 20 2712 04 81  
www.amphenol-in.com

## Italy

Amphenol-Tuchel Italy  
Via Barbaiana n. 5  
20020 Lainate (MI)  
Phone +39 02 9325 41  
www.amphenol.info

## Korea

Amphenol DaeShin Elect and  
Precision Co.,Ltd  
558 Songnae-Dong, Sosa-Gu  
Bucheon-City, Kyunggi-Do  
Korea 422-130  
Phone +82 32 6103 800  
www.amphenol.co.kr

## Mexico

Amphenol Mexico  
Prolongacion Reforma 61 - 6 B2  
Col. Paseo de las Lomas  
C.P. 01330 Mexico D.F.  
Phone +52 55 5258 99 84  
www.amphenolmexico.com

## Singapore

Asia Pacific Sales Operations  
72 Bendemeer Rd, No.03-32/33  
Hiap Huat House, Luzerne, 339941  
Singapore  
Phone +65 6294 2128  
www.amphenol.com

## South Africa

Amphenol International Ltd  
Chislehurst  
30 Impala Road  
2196 Chislehurst  
Sandton, 2146  
Phone +27 11 7839 517  
www.amphenol.co.za

## Spain

Amphenol Espana  
Edificio Burgosal, Oficina 55  
C/Comunidad de Madrid, 35 bis  
Las Rozas (Madrid), 28230  
Phone +34 91 6407 302  
www.amphenol.com

## Taiwan

Amphenol East Asia Limited-Taiwan  
5F, No. 361, Fusing 1st Rd  
Gueishan Township,  
Taoyuan County 333  
Phone +886 3 2647 200  
www.amphenol.com

Amphenol LTW Technology Co., Ltd.  
9F, No. 657-12, Zhongzheng Road  
Xinzhuang Dist., New Taipei City  
242 Taiwan  
Phone +886 2 2908 5626  
sales@ltw-tech.com  
www.amphenolltw.com

## Turkey

Amphenol Turkey  
Sun Plaza Kat: 15  
Maslak Mah. Bilim Sok.No:15  
34398 Sisli - Istanbul  
Phone: +90 2123 679 220  
www.amphenol.com.tr

## United Kingdom

Amphenol Limited  
Thanet Way, Whitstable  
Kent, CT53JF  
Phone +44 1227 773 200  
www.amphenol.co.uk

## USA

Amphenol-Tuchel Electronics  
6900 Haggerty Road  
Suite 200  
Canton, Michigan 48187  
Phone +1 7344 516 400  
www.amphenol.info

Amphenol Corporation  
Corporate Headquarters  
358 Hall Avenue  
Wallingford, CT 06492  
Phone +1 877 2674 366  
Phone +1 203 2658 900  
www.amphenol.com

More Amphenol companies can be  
found here: [www.amphenol.com](http://www.amphenol.com)



All technical data have been measured in a laboratory environment and can be different during practical usage of the product. Any product information is for descriptive usage only and not legally binding; particularly the information does not constitute or provide any legal guaranties ("Beschaffensgarantie" or "Haltbarkeitsgarantie").

We reserve the right to change the design due to improvement in quality, development or production requirements. This catalogue must not be used in any form or manner without our prior approval in writing (Copyright Law, Fair Trading Law, Civil Code).

Your engineering sales representative:



Компания «ЭлектроПласт» предлагает заключение долгосрочных отношений при поставках импортных электронных компонентов на взаимовыгодных условиях!

Наши преимущества:

- Оперативные поставки широкого спектра электронных компонентов отечественного и импортного производства напрямую от производителей и с крупнейших мировых складов;
- Поставка более 17-ти миллионов наименований электронных компонентов;
- Поставка сложных, дефицитных, либо снятых с производства позиций;
- Оперативные сроки поставки под заказ (от 5 рабочих дней);
- Экспресс доставка в любую точку России;
- Техническая поддержка проекта, помощь в подборе аналогов, поставка прототипов;
- Система менеджмента качества сертифицирована по Международному стандарту ISO 9001;
- Лицензия ФСБ на осуществление работ с использованием сведений, составляющих государственную тайну;
- Поставка специализированных компонентов (Xilinx, Altera, Analog Devices, Intersil, Interpoint, Microsemi, Aeroflex, Peregrine, Syfer, Eurofarad, Texas Instrument, Miteq, Cobham, E2V, MA-COM, Hittite, Mini-Circuits, General Dynamics и др.);

Помимо этого, одним из направлений компании «ЭлектроПласт» является направление «Источники питания». Мы предлагаем Вам помощь Конструкторского отдела:

- Подбор оптимального решения, техническое обоснование при выборе компонента;
- Подбор аналогов;
- Консультации по применению компонента;
- Поставка образцов и прототипов;
- Техническая поддержка проекта;
- Защита от снятия компонента с производства.



#### Как с нами связаться

**Телефон:** 8 (812) 309 58 32 (многоканальный)

**Факс:** 8 (812) 320-02-42

**Электронная почта:** [org@eplast1.ru](mailto:org@eplast1.ru)

**Адрес:** 198099, г. Санкт-Петербург, ул. Калинина, дом 2, корпус 4, литера А.