

EN3® SERIES WEATHERTIGHT CONNECTORS - 26 AWG 9-18 CRIMP CONTACTS & CLAMPING SYSTEM

Features and Benefits

- Easier to assemble
- New longer cable clamp secures cable up to .380
- New thicker heavier boot seals cable diameters between .230 & .380
- Brass nut secures cable clamp
- New crimp pins/contacts eliminate soldering
- Gold plated contacts standard
- Withstands 2 meter submersion for 24 hours

Product Specifications

Materials

Connector Shell, Contact Locking Disc: Thermoplastic polymer glass fiber, flame retardant

Cable Clamp: High grade thermoplastic

Boot, Connector Shell Interior: Thermoplastic elastomer

Contacts: Copper base alloy, gold plated over nickel underplate

Mechanical

Shock: Mil-Std 202 Method 213B, Condition K

Vibration: Mil-Std 202 Method 201A

Life: 600 insertion/withdraw cycles minimum

Electrical

Voltage Rating (Sea Level): Tested at 600 VRMS

Insulation Resistance: 100 megohms minimum at 77° F.

Contact Resistance: 5 milliohms maximum

Current Rating: 3 Amps

Environmental

Temperature Limits: -40° C to +65° C (non-operating)

Moisture Resistance: Mil-Std 202 Method 106F

Insulation Resistance: Mil-Std Method 302 Condition B

Thermal Shock: Mil-Std 202 Method 107G

Salt Spray: Mil-Std 202 Method 101D Condition B

Water Tightness Test: U.S. Coast Guard CFR 46 Part 110.20

Product Ratings

IP16/IP18

IP66/IP68

NEMA 250 (6P)

CFR 46 Part 110.20

UL 94V-0



Assembled EN3 with Large Boot



Panel Mount with Crimp Contacts



New Boot & Clamp with Ring

EN3™ MINI WEATHERTIGHT - 26 AWG MULTI-PIN SERIES

Cable End

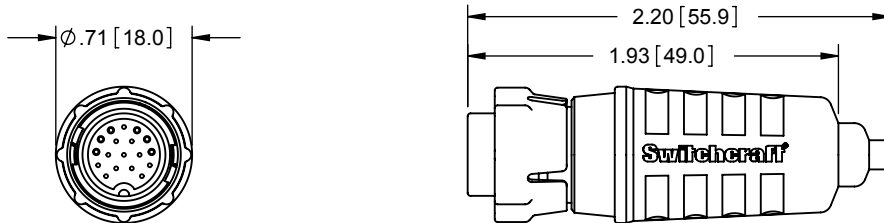

Panel Mount

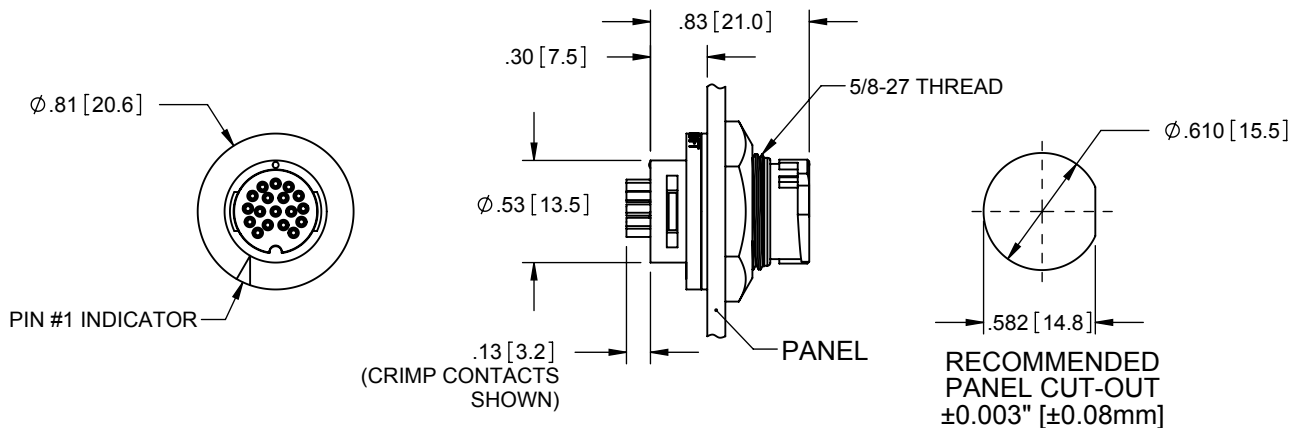

In-Line

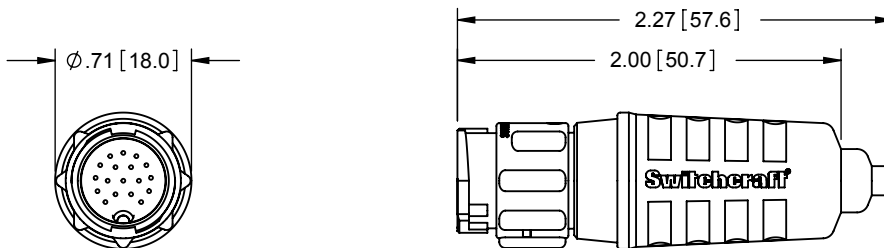

Contact Arrangements (Wiring View of Cable End)

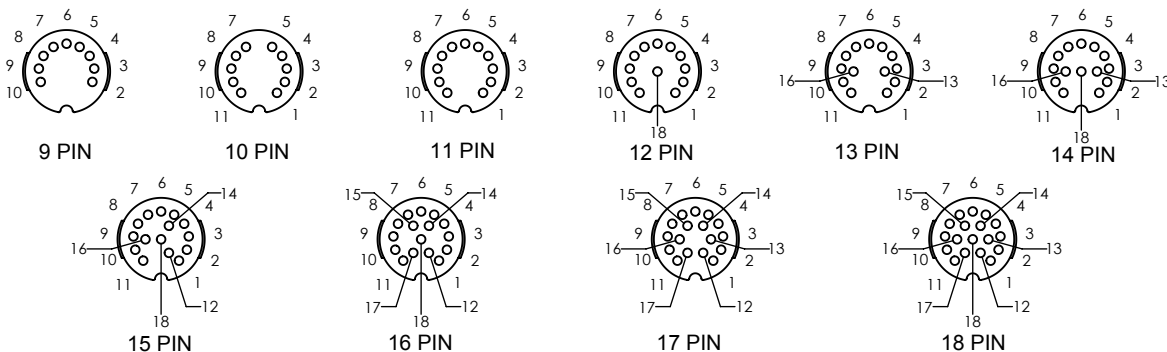

NEW CABLE CLAMP SYSTEM FOR LARGER O.D. CABLE

For cable O.D. 0.230" to 0.380" [5.8 - 9.7] and maximum cable jacket stripping of 0.750" [9.1] long.

Note: Cable clamp system, for cable O.D. 0.090" to 0.265" [2.3 - 6.7] and maximum cable jacket stripping of 0.375" [9.5] long, still available.

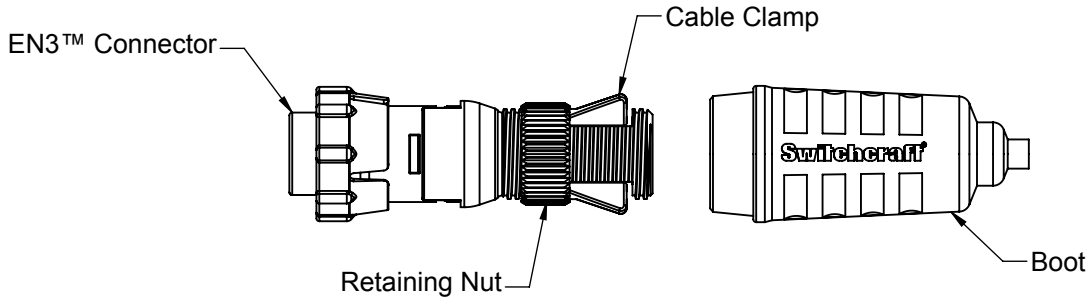

EN3™ SERIES PLUG CAPS

EN3IPCAP

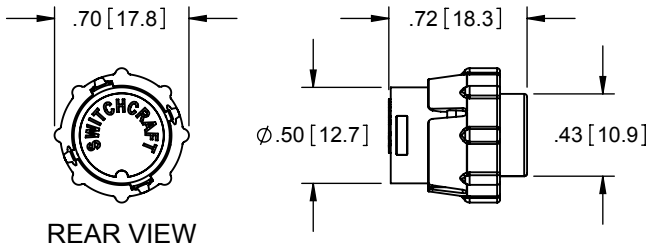

EN3CAP

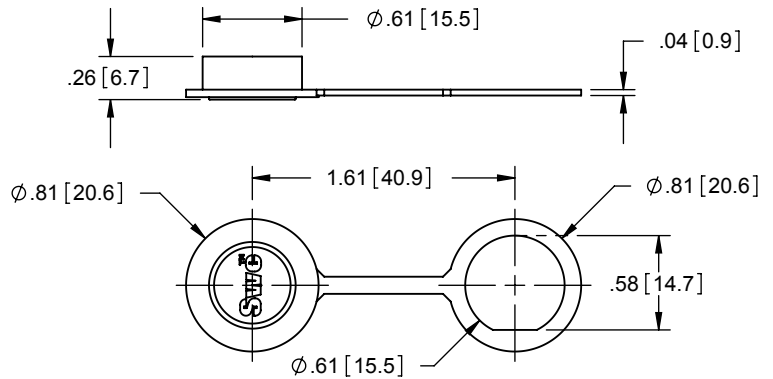

All dimensions for reference only.

EN3™ SERIES ORDERING CODE



Connector Type:

- C - Cord
- P - Panel
- L - In-Line

of Contacts:

- 2-3 for #16
- 2-8 for #20
- 9-18 for #26

Gender:

- M - Male
- F - Female

Contact Size:

- 16 - 16 AWG
- Leave blank for 20 AWG
- 26 - 26 AWG

Cable Clamp system option:

- L - for 0.230" to 0.380" cable nom. O.D. and 0.750" long stripping.
- Leave blank for 0.160" to 0.265" cable nom. O.D. and 0.380" long stripping.

Packaging Options:

- K - Kit
- Leave blank for Bulk

Contact plating:

- AG - Silver
- Leave blank for Gold

Contact Style:

- C - Crimp
- P - PC tail
- S - Staggered Solder Cup
- Leave blank for Straight Solder Cup

Notes:

- 7 and 8 pin not available in male Cord or In-Line connector
- 7 and 8 pin not available in female In-Line connector
- AG (silver plating) special order

EN3™ SERIES FIELD ASSEMBLY INSTRUCTIONS FOR CRIMP CONTACTS:

STEP 1:

PRESS THE TWO WINGS OF CABLE CLAMP INWARD, THEN THREAD NUT CLOCKWISE ONTO CABLE CLAMP TO THE POSITION SHOWN.

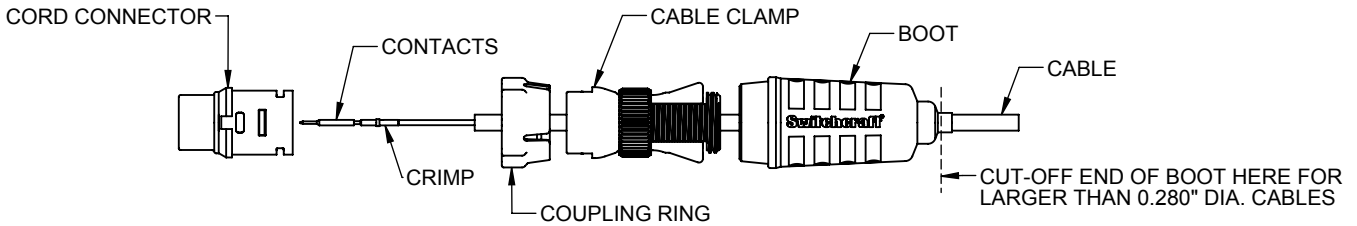
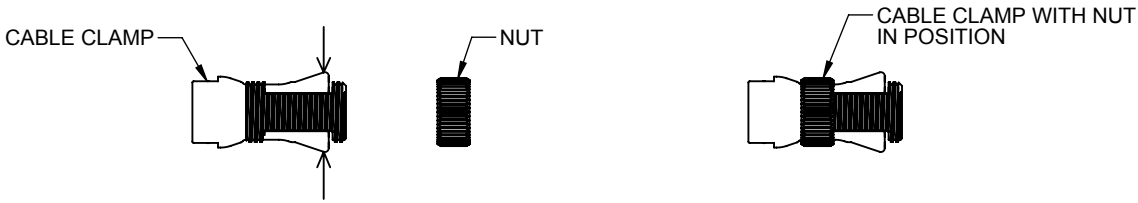

STEP 2:

FEED THE FREE END OF CABLE THROUGH BOOT, CABLE CLAMP, AND COUPLING RING IN THE ORDER SHOWN.
NOTE: CUT-OFF END OF BOOT FOR LARGER THAN 0.280" DIAMETER CABLES.

STRIP CABLE END AND CONDUCTORS AS SHOWN.
CRIMP CONDUCTORS TO CONTACTS.
USE CRIMP HAND TOOL EN3CR OR PNEUMATIC CRIMP TOOL EN3CRAUTO WITH #26 POSITIONER EN3POS26.
INSERT CONTACTS TO CONNECTOR HOUSING PER CONTACT ARRANGEMENTS AND INSERTION INSTRUCTIONS.

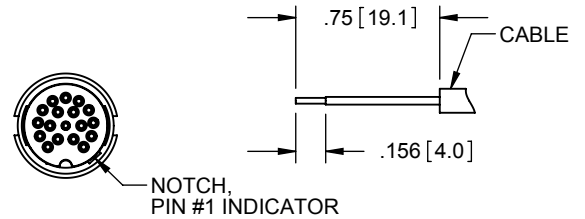

CORD WIRING SIDE VIEW

TYPICAL CONTACT INSERTION INSTRUCTIONS:
PLACE CONTACT IN GROOVE OF INSERTION HAND TOOL EN3INS26. NOTE: TIP OF TOOL SHOULD BE UP AGAINST THE SHOULDER OF CONTACT.

INSERT CONTACT INTO CORRECT CAVITY OF CONNECTOR BODY BY APPLYING CONSTANT PRESSURE UNTIL CONTACT BOTTOMS UP AGAINST LOCKING DISC.
NOTE: DO NOT TILT TOOL DURING THE INSERTION.

REPEAT ABOVE PROCEDURE TO INSERT ALL CONTACTS PER CONTACT ARRANGEMENTS.

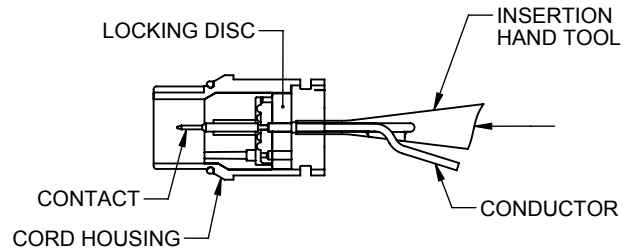

STEP 3:

ALIGN TABS OF COUPLING RING WITH NOTCHES OF CORD HOUSING AND PUSH COUPLING RING ONTO CORD HOUSING.

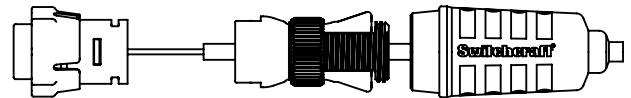

STEP 4:

ALIGN CABLE CLAMP AND PUSH FORWARD UNTIL IT SNAP-LOCKS ONTO THE REAR OF CONNECTOR HOUSING. TURN NUT OF CABLE CLAMP COUNTERCLOCKWISE UNTIL CABLE CLAMP TIGHTENS AGAINST CABLE.

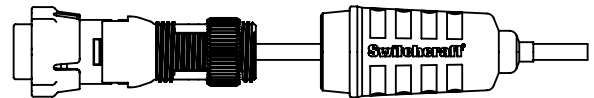

STEP 5:

PUSH BOOT ALL THE WAY FORWARD, OVER CABLE CLAMP, UNTIL FRONT END OF BOOT SEALS TIGHTLY ONTO CONNECTOR HOUSING.

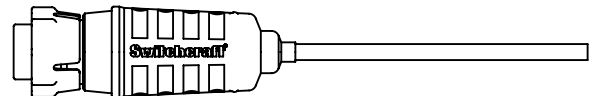



Компания «ЭлектроПласт» предлагает заключение долгосрочных отношений при поставках импортных электронных компонентов на взаимовыгодных условиях!

Наши преимущества:

- Оперативные поставки широкого спектра электронных компонентов отечественного и импортного производства напрямую от производителей и с крупнейших мировых складов;
- Поставка более 17-ти миллионов наименований электронных компонентов;
- Поставка сложных, дефицитных, либо снятых с производства позиций;
- Оперативные сроки поставки под заказ (от 5 рабочих дней);
- Экспресс доставка в любую точку России;
- Техническая поддержка проекта, помощь в подборе аналогов, поставка прототипов;
- Система менеджмента качества сертифицирована по Международному стандарту ISO 9001;
- Лицензия ФСБ на осуществление работ с использованием сведений, составляющих государственную тайну;
- Поставка специализированных компонентов (Xilinx, Altera, Analog Devices, Intersil, Interpoint, Microsemi, Aeroflex, Peregrine, Syfer, Eurofarad, Texas Instrument, Miteq, Cobham, E2V, MA-COM, Hittite, Mini-Circuits, General Dynamics и др.);

Помимо этого, одним из направлений компании «ЭлектроПласт» является направление «Источники питания». Мы предлагаем Вам помощь Конструкторского отдела:

- Подбор оптимального решения, техническое обоснование при выборе компонента;
- Подбор аналогов;
- Консультации по применению компонента;
- Поставка образцов и прототипов;
- Техническая поддержка проекта;
- Защита от снятия компонента с производства.



Как с нами связаться

Телефон: 8 (812) 309 58 32 (многоканальный)

Факс: 8 (812) 320-02-42

Электронная почта: org@eplast1.ru

Адрес: 198099, г. Санкт-Петербург, ул. Калинина, дом 2, корпус 4, литера А.