

**HIGH RIPPLE-REJECTION AND LOW DROPOUT
CMOS VOLTAGE REGULATOR**www.ablic.com

© ABLIC Inc., 2001-2012

Rev.5.1_02

The S-L2980 Series is a positive voltage regulator with a low dropout voltage, high output voltage accuracy, and low current consumption developed based on CMOS technology.

A built-in low on-resistance transistor provides a low dropout voltage and a large output current. A ON/OFF circuit ensures long battery life.

Various types of output capacitors can be used in the S-L2980 Series compared with the conventional CMOS voltage regulators. A small ceramic capacitor can also be used.

■ Features

- Output voltage: 1.5 V to 6.0 V, selectable in 0.1 V steps
- Output voltage accuracy: $\pm 2.0\%$
- Dropout voltage: 120 mV typ. (3.0 V output product, $I_{OUT}=50$ mA)
- Current consumption: During operation: 90 μ A typ., 140 μ A max.
During power-off: 0.1 μ A typ., 1.0 μ A max.
- Output current: Possible to output 150 mA ($V_{IN} \geq V_{OUT(S)} + 1.0$ V)^{*1}
- Output capacitor: A ceramic capacitor of 1.0 μ F or more can be used.
(A ceramic capacitor of 2.2 μ F or more can be used for the products whose output voltage is 1.7 V or less.)
- Ripple rejection: 70 dB typ. (f=1.0 kHz)
- Built-in ON/OFF circuit: Ensures long battery life.
- Operation temperature range: $T_a = -40^\circ\text{C}$ to $+85^\circ\text{C}$
- Lead-free, Sn 100%, halogen-free^{*2}

*1. Attention should be paid to the power dissipation of the package when the load is large.

*2. Refer to “**■ Product Name Structure**” for details.

■ Applications

- Power supply for battery-powered device
- Power supply for personal communication device
- Power supply for home electric appliance
- Power supply for cellular phone

■ Package

- SOT-23-5

■ Block Diagram



*1. Parasitic diode

Figure 1

■ **Product Name Structure**

- The product types and output voltage for S-L2980 Series can be selected at the user’s request. Refer to the “**1. Product Name**” for the meanings of the characters in the product name, “**2. Package**” regarding the package drawings and “**3. Product Name List**” for the full product names.

1. Product Name

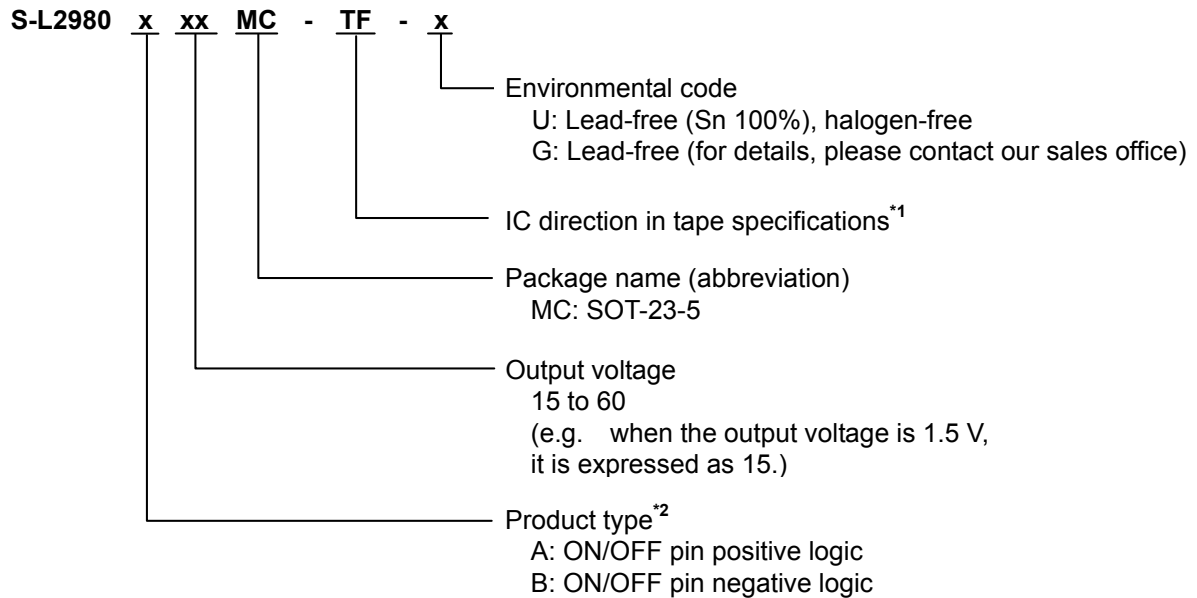

*1. Refer to the tape drawing.

*2. Refer to the “**3. ON/OFF Pin**” in the “**■ Operation**”.

2. Package

Package Name	Drawing Code		
	Package	Tape	Reel
SOT-23-5	MP005-A-P-SD	MP005-A-C-SD	MP005-A-R-SD

3. Product Name List

Table 1

Output Voltage	SOT-23-5
1.5 V \pm 2.0 %	S-L2980A15MC-TF-x
1.6 V \pm 2.0 %	S-L2980A16MC-TF-x
1.7 V \pm 2.0 %	S-L2980A17MC-TF-x
1.8 V \pm 2.0 %	S-L2980A18MC-TF-x
1.9 V \pm 2.0 %	S-L2980A19MC-TF-x
2.0 V \pm 2.0 %	S-L2980A20MC-TF-x
2.1 V \pm 2.0 %	S-L2980A21MC-TF-x
2.2 V \pm 2.0 %	S-L2980A22MC-TF-x
2.3 V \pm 2.0 %	S-L2980A23MC-TF-x
2.4 V \pm 2.0 %	S-L2980A24MC-TF-x
2.5 V \pm 2.0 %	S-L2980A25MC-TF-x
2.6 V \pm 2.0 %	S-L2980A26MC-TF-x
2.7 V \pm 2.0 %	S-L2980A27MC-TF-x
2.8 V \pm 2.0 %	S-L2980A28MC-TF-x
2.9 V \pm 2.0 %	S-L2980A29MC-TF-x
3.0 V \pm 2.0 %	S-L2980A30MC-TF-x
3.1 V \pm 2.0 %	S-L2980A31MC-TF-x
3.2 V \pm 2.0 %	S-L2980A32MC-TF-x
3.3 V \pm 2.0 %	S-L2980A33MC-TF-x
3.4 V \pm 2.0 %	S-L2980A34MC-TF-x
3.5 V \pm 2.0 %	S-L2980A35MC-TF-x
3.6 V \pm 2.0 %	S-L2980A36MC-TF-x
3.7 V \pm 2.0 %	S-L2980A37MC-TF-x
3.8 V \pm 2.0 %	S-L2980A38MC-TF-x
3.9 V \pm 2.0 %	S-L2980A39MC-TF-x
4.0 V \pm 2.0 %	S-L2980A40MC-TF-x
4.1 V \pm 2.0 %	S-L2980A41MC-TF-x
4.2 V \pm 2.0 %	S-L2980A42MC-TF-x
4.3 V \pm 2.0 %	S-L2980A43MC-TF-x
4.4 V \pm 2.0 %	S-L2980A44MC-TF-x
4.5 V \pm 2.0 %	S-L2980A45MC-TF-x
4.6 V \pm 2.0 %	S-L2980A46MC-TF-x
4.7 V \pm 2.0 %	S-L2980A47MC-TF-x
4.8 V \pm 2.0 %	S-L2980A48MC-TF-x
4.9 V \pm 2.0 %	S-L2980A49MC-TF-x
5.0 V \pm 2.0 %	S-L2980A50MC-TF-x
5.1 V \pm 2.0 %	S-L2980A51MC-TF-x
5.2 V \pm 2.0 %	S-L2980A52MC-TF-x
5.3 V \pm 2.0 %	S-L2980A53MC-TF-x
5.4 V \pm 2.0 %	S-L2980A54MC-TF-x
5.5 V \pm 2.0 %	S-L2980A55MC-TF-x
5.6 V \pm 2.0 %	S-L2980A56MC-TF-x
5.7 V \pm 2.0 %	S-L2980A57MC-TF-x
5.8 V \pm 2.0 %	S-L2980A58MC-TF-x
5.9 V \pm 2.0 %	S-L2980A59MC-TF-x
6.0 V \pm 2.0 %	S-L2980A60MC-TF-x

- Remark 1.** Please contact our sales office for type B products.
2. x: G or U
3. Please select products of environmental code = U for Sn 100%, halogen-free products.

■ Pin Configuration

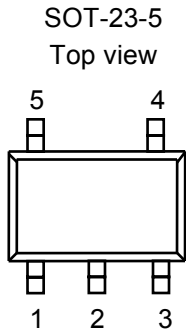

Figure 2

Table 2

Pin No.	Symbol	Pin Description
1	V _{IN}	Input voltage pin
2	V _{SS}	GND pin
3	ON/OFF	ON/OFF pin
4	NC*1	No connection
5	V _{OUT}	Output voltage pin

*1. The NC pin is electrically open.
The NC pin can be connected to V_{IN} or V_{SS}.

■ Absolute Maximum Ratings

Table 3

(T_a=25 °C unless otherwise specified)

Item	Symbol	Absolute Maximum Rating	Unit
Input voltage	V _{IN}	V _{SS} -0.3 to V _{SS} +12	V
	V _{ON/OFF}	V _{SS} -0.3 to V _{SS} +12	V
Output voltage	V _{OUT}	V _{SS} -0.3 to V _{IN} +0.3	V
Power dissipation	P _D	300 (When not mounted on board)	mW
		600*1	mW
Operation ambient temperature	T _{opr}	-40 to +85	°C
Storage temperature	T _{stg}	-40 to +125	°C

*1. When mounted on board

[Mounted board]

(1) Board size : 114.3 mm × 76.2 mm × t1.6 mm

(2) Board name : JEDEC STANDARD51-7

Caution The absolute maximum ratings are rated values exceeding which the product could suffer physical damage. These values must therefore not be exceeded under any conditions.



Figure 3 Power Dissipation of Package (When Mounted on Board)

■ **Electrical Characteristics**

Table 4

(Ta=25 °C unless otherwise specified)

Item	Symbol	Condition	Min.	Typ.	Max.	Unit	Test circuit	
Output voltage ^{*1}	$V_{OUT(E)}$	$V_{IN} = V_{OUT(S)} + 1.0 \text{ V}$, $I_{OUT} = 50 \text{ mA}$	$V_{OUT(S)} \times 0.98$	$V_{OUT(S)}$	$V_{OUT(S)} \times 1.02$	V	1	
Output current ^{*2}	I_{OUT}	$V_{IN} \geq V_{OUT(S)} + 1.0 \text{ V}$	150 ^{*5}	—	—	mA	3	
Dropout voltage ^{*3}	V_{drop}	$I_{OUT} = 50 \text{ mA}$	$1.5 \text{ V} \leq V_{OUT(S)} \leq 1.7 \text{ V}$	—	0.17	0.33	V	1
			$1.8 \text{ V} \leq V_{OUT(S)} \leq 1.9 \text{ V}$	—	0.16	0.29	V	1
			$2.0 \text{ V} \leq V_{OUT(S)} \leq 2.4 \text{ V}$	—	0.15	0.26	V	1
			$2.5 \text{ V} \leq V_{OUT(S)} \leq 2.9 \text{ V}$	—	0.13	0.20	V	1
			$3.0 \text{ V} \leq V_{OUT(S)} \leq 3.2 \text{ V}$	—	0.12	0.15	V	1
			$3.3 \text{ V} \leq V_{OUT(S)} \leq 6.0 \text{ V}$	—	0.11	0.14	V	1
Line regulation	$\frac{\Delta V_{OUT1}}{\Delta V_{IN} \bullet V_{OUT}}$	$V_{OUT(S)} + 0.5 \text{ V} \leq V_{IN} \leq 10 \text{ V}$, $I_{OUT} = 50 \text{ mA}$	—	0.05	0.2	%/V	1	
Load regulation	ΔV_{OUT2}	$V_{IN} = V_{OUT(S)} + 1.0 \text{ V}$, $1.0 \text{ mA} \leq I_{OUT} \leq 80 \text{ mA}$	—	12	40	mV	1	
Output voltage temperature coefficient ^{*4}	$\frac{\Delta V_{OUT}}{\Delta T_a \bullet V_{OUT}}$	$V_{IN} = V_{OUT(S)} + 1.0 \text{ V}$, $I_{OUT} = 50 \text{ mA}$, $-40^\circ\text{C} \leq T_a \leq 85^\circ\text{C}$	—	± 100	—	ppm/ °C	1	
Current consumption during operation	I_{SS1}	$V_{IN} = V_{OUT(S)} + 1.0 \text{ V}$, ON/OFF pin=ON, No load	—	90	140	μA	2	
Current consumption during power-off	I_{SS2}	$V_{IN} = V_{OUT(S)} + 1.0 \text{ V}$, ON/OFF pin =OFF, No load	—	0.1	1.0	μA	2	
Input voltage	V_{IN}	—	2.0	—	10	V	—	
ON/OFF pin input voltage "H"	V_{SH}	$V_{IN} = V_{OUT(S)} + 1.0 \text{ V}$, $R_L = 1.0 \text{ k}\Omega$	1.5	—	—	V	4	
ON/OFF pin input voltage "L"	V_{SL}	$V_{IN} = V_{OUT(S)} + 1.0 \text{ V}$, $R_L = 1.0 \text{ k}\Omega$	—	—	0.3	V	4	
ON/OFF pin input current "H"	I_{SH}	$V_{IN} = V_{OUT(S)} + 1.0 \text{ V}$, $V_{ON/OFF} = 7.0 \text{ V}$	-0.1	—	0.1	μA	4	
ON/OFF pin input current "L"	I_{SL}	$V_{IN} = V_{OUT(S)} + 1.0 \text{ V}$, $V_{ON/OFF} = 0 \text{ V}$	-0.1	—	0.1	μA	4	
Ripple rejection	RR	$V_{IN} = V_{OUT(S)} + 1.0 \text{ V}$, $f = 1.0 \text{ kHz}$, $\Delta V_{rip} = 0.5 \text{ V rms}$, $I_{OUT} = 50 \text{ mA}$	$1.5 \text{ V} \leq V_{OUT(S)} \leq 3.3 \text{ V}$	—	70	—	dB	5
			$3.4 \text{ V} \leq V_{OUT(S)} \leq 5.0 \text{ V}$	—	65	—	dB	5
			$5.1 \text{ V} \leq V_{OUT(S)} \leq 6.0 \text{ V}$	—	60	—	dB	5

*1. $V_{OUT(S)}$: Set output voltage

$V_{OUT(E)}$: Actual output voltage at the fixed load

The output voltage when fixing $I_{OUT}(=50 \text{ mA})$ and inputting $V_{OUT(S)} + 1.0 \text{ V}$

*2. Output current at which output voltage becomes 95 % of V_{OUT} after gradually increasing output current.

*3. $V_{drop} = V_{IN1} - (V_{OUT} \times 0.98)$

V_{IN1} is the input voltage at which output voltage becomes 98 % of V_{OUT} after gradually decreasing input voltage.

*4. Temperature change ratio in the output voltage [mV/°C] is calculated by using the following equation.

$$\frac{\Delta V_{OUT}}{\Delta T_a} [\text{mV}/^\circ\text{C}]^{*1} = V_{OUT(S)} [\text{V}]^{*2} \times \frac{\Delta V_{OUT}}{\Delta T_a \bullet V_{OUT}} [\text{ppm}/^\circ\text{C}]^{*3} \div 1000$$

*1. Temperature change ratio of the output voltage

*2. Set output voltage

*3. Output voltage temperature coefficient

*5. The output current can be supplied at least to this value.

Due to restrictions on the package power dissipation, this value may not be satisfied.

Attention should be paid to the power dissipation of the package when the load is large.

This specification is guaranteed by design.

■ Test Circuits

1.



Figure 4

2.



Figure 5

3.



Figure 6

4.



Figure 7

5.



Figure 8

■ Standard Circuit



*1. C_{IN} is a capacitor used to stabilize input.

*2. A ceramic capacitor of 1.0 μF or more can be used for C_L , provided that a ceramic capacitor of 2.2 μF or more can be used for the product whose output voltage is 1.7 V or less.

Figure 9

Caution The above connection diagram and constant will not guarantees successful operation. Perform through evaluation using the actual application to set the constant.

■ Application Conditions

Input capacitor (C_{IN}):	0.47 μF or more
Input series resistance (R_{IN}):	10 Ω or less
Output capacitor (C_L):	1.0 μF or more ^{*1}
Equivalent Series Resistance (ESR) for output capacitor:	10 Ω or less

*1. If the product whose output voltage is 1.7 V or less will be used, the capacitance should be 2.2 μF or more.

Caution Generally a series regulator may cause oscillation, depending on the selection of external parts. Confirm that no oscillation occurs in the application for which the above capacitors are used.

■ Explanation of Terms

1. Low Dropout Voltage Regulator

This voltage regulator has the low dropout voltage due to its built-in low on-resistance transistor.

2. Low ESR

Low ESR means the Equivalent Series Resistance of a capacitor is small. The low ESR ceramics output capacitor (C_L) can be used in the S-L2980 Series. A capacitor whose ESR is 10Ω or less can be used.

3. Output Voltage (V_{OUT})

The accuracy of the output voltage is ensured at $\pm 2.0\%$ under the specified conditions of fixed input voltage^{*1}, fixed output current, and fixed temperature.

*1. Differs depending upon the product.

Caution If the above conditions change, the output voltage value may vary and exceed the accuracy range of the output voltage. Refer to the “■ Electrical Characteristics” and “■ Typical Characteristics” for details.

4. Line Regulation $\left(\frac{\Delta V_{OUT1}}{\Delta V_{IN} \cdot V_{OUT}} \right)$

Indicates the dependency of the output voltage on the input voltage. That is, the value shows how much the output voltage changes due to a change in the input voltage with the output current remaining unchanged.

5. Load Regulation (ΔV_{OUT2})

Indicates the dependency of the output voltage on the output current. That is, the value shows how much the output voltage changes due to a change in the output current with the input voltage remaining unchanged.

6. Dropout Voltage (V_{drop})

Indicates the difference between the input voltage (V_{IN1}) and output voltage when the output voltage falls to 98 % of the output voltage ($V_{OUT(E)}$) by gradually decreasing the input voltage.

$$V_{drop} = V_{IN1} - (V_{OUT(E)} \times 0.98)$$

7. Output Voltage Temperature Coefficient $\left(\frac{\Delta V_{OUT}}{\Delta Ta \cdot V_{OUT}}\right)$

The shaded area in **Figure 10** is the range where V_{OUT} varies in operation temperature range when the output voltage temperature coefficient is ± 100 ppm/ $^{\circ}C$.



*1. $V_{OUT(E)}$ is the value of the output voltage measured at $T_a = +25^{\circ}C$.

Figure 10

A change in the temperature of the output voltage [mV/ $^{\circ}C$] is calculated using the following equation.

$$\frac{\Delta V_{OUT}}{\Delta Ta} \text{ [mV}/^{\circ}C]^*1 = V_{OUT(S)} \text{ [V]}^*2 \times \frac{\Delta V_{OUT}}{\Delta Ta \cdot V_{OUT}} \text{ [ppm}/^{\circ}C]^*3 \div 1000$$

- *1. Change in temperature of output voltage
- *2. Set output voltage
- *3. Output voltage temperature coefficient

■ Operation

1. Basic Operation

Figure 11 shows the block diagram of the S-L2980 Series.

The error amplifier compares the reference voltage (V_{ref}) with feedback voltage (V_{fb}), which is the output voltage resistance-divided by feedback resistors (R_s and R_f). It supplies the gate voltage necessary to maintain the constant output voltage which is not influenced by the input voltage and temperature change, to the output transistor.



*1. Parasitic diode

Figure 11

2. Output Transistor

In the S-L2980 Series, a low on-resistance P-channel MOS FET is used as the output transistor.

Be sure that V_{OUT} does not exceed $V_{IN} + 0.3$ V to prevent the voltage regulator from being damaged due to inverse current flowing from the VOUT pin through a parasitic diode to the VIN pin.

3. ON/OFF Pin

This pin starts and stops the regulator.

When the ON/OFF pin is set to OFF level, the operation of all internal circuits stops, the built-in P-channel MOS FET output transistor between VIN pin and VOUT pin is turned off to make current consumption drastically reduced. The VOUT pin becomes the V_{SS} level due to internally divided resistance of several hundreds kΩ between the VOUT pin and VSS pin.

Furthermore, the structure of the ON/OFF pin is as shown in **Figure 12**. Since the ON/OFF pin is neither pulled down nor pulled up internally, do not use it in the floating state. In addition, please note that current consumption increases if a voltage of 0.3 V to VIN–0.3 V is applied to the ON/OFF pin.

When the ON/OFF pin is not used, connect it to the VIN pin in case the product type is “A” and to the VSS pin in case of “B”.

Table 5

Product Type	ON/OFF Pin	Internal Circuit	VOUT Pin Voltage	Current Consumption
A	“H”: ON	Operate	Set value	I _{SS1}
A	“L”: OFF	Stop	V _{SS} level	I _{SS2}
B	“H”: OFF	Stop	V _{SS} level	I _{SS2}
B	“L”: ON	Operate	Set value	I _{SS1}



Figure 12

■ Selection of Output Capacitor (C_L)

The S-L2980 Series needs an output capacitor between VOUT pin and VSS pin for phase compensation. A ceramic capacitor whose capacitance is 1.0 μF or more*1 can be used. When an OS (Organic Semiconductor) capacitor, a tantalum capacitor or an aluminum electrolyte capacitor is used, the capacitance should be 2.2 μF or more and the ESR should be 10 Ω or less.

The value of the output overshoot or undershoot transient response varies depending on the value of the output capacitor.

Sufficient evaluation including temperature dependency in the actual environment is needed.

*1. If the product whose output voltage is 1.7 V or less will be used, the capacitance should be 2.2 μF or more.

■ Precautions

- Wiring patterns for VIN pin, VOUT pin and GND pin should be designed to hold low impedance. When mounting an output capacitor between the VOUT and VSS pins (C_L) and a capacitor for stabilizing the input between VIN and VSS pins (C_{IN}), the distance from the capacitors to these pins should be as short as possible.
- Note that output voltage may increase when a series regulator is used at low load current (1.0 mA or less).
- Generally a series regulator may cause oscillation, depending on the selection of external parts. The following conditions are recommended for this IC. However, be sure to perform sufficient evaluation under the actual usage conditions for selection, including evaluation of temperature characteristics.

Input capacitor (C_{IN}):	0.47 μ F or more
Output capacitor (C_L):	1.0 μ F or more*1
Equivalent Series Resistance (ESR):	10 Ω or less
Input series resistance (R_{IN}):	10 Ω or less

*1. If the product whose output voltage will be is 1.7 V or less is used, the capacitance should be 2.2 μ F or more.

- A voltage regulator may oscillate when the impedance of the power supply is high and the input capacitor is small or not connected.
- Overshoot may occur in the output voltage momentarily if the voltage is rapidly raised at power-on or when the power supply fluctuates. Sufficiently evaluate the output voltage at power-on with the actual device.
- The application condition for input voltage, output voltage and load current should not exceed the package power dissipation.
- Do not apply an electrostatic discharge to this IC that exceeds the performance ratings of the built-in electrostatic protection circuit.
- In determining output current attention should be paid to the output current value specified in the **Table 4** for “**■ Electrical Characteristics**” and the footnote *5.
- ABLIC Inc. claims no responsibility for any and all disputes arising out of or in connection with any infringement of the products including this IC upon patents owned by a third party.

■ **Typical Characteristics**

1. Output Voltage versus Output Current (When Load Current Increases)

S-L2980A15 (Ta=25°C)



S-L2980A30 (Ta=25°C)



S-L2980A50 (Ta=25°C)

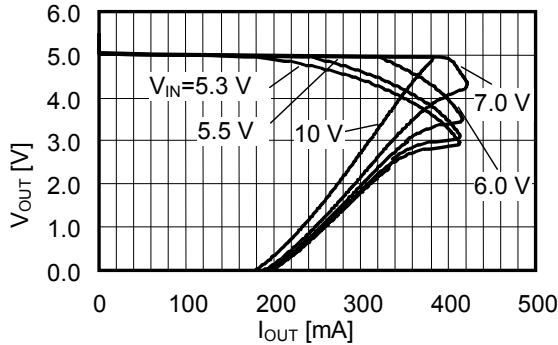

Remark In determining output current, attention should be paid to the followings.

- 1) The minimum output current value and footnote *5 in the **Table 4** for the "■ **Electrical Characteristics**".
- 2) The package power dissipation

2. Maximum Output Current versus Input Voltage

S-L2980A15 (Short-circuit protection included)

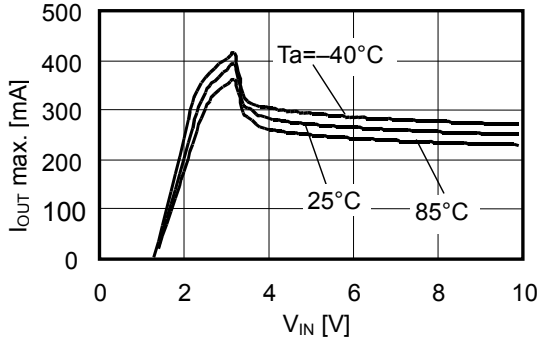

S-L2980A30 (Short-circuit protection included)

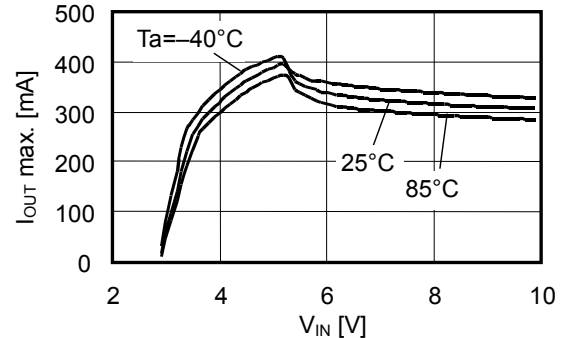

S-L2980A50 (Short circuit protection included)

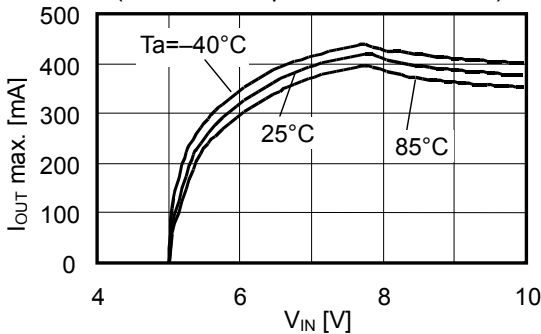

Remark In determining output current, attention should be paid to the followings.

- 1) The minimum output current value and footnote *5 in the **Table 4** for the "■ **Electrical Characteristics**".
- 2) The package power dissipation

3. Output Voltage versus Input Voltage

S-L2980A15 (Ta=25°C)



S-L2980A30 (Ta=25°C)



S-L2980A50 (Ta=25°C)



4. Dropout Voltage versus Output Voltage

S-L2980A15



S-L2980A30

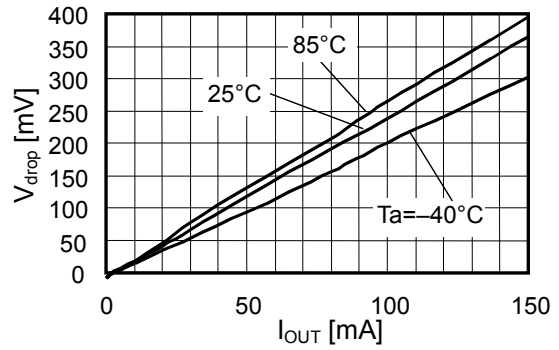

S-L2980A50



5. Output Voltage versus Ambient Temperature

S-L2980A15



S-L2980A30



S-L2980A50



6. Line Regulation versus Ambient Temperature

S-L2980Axx



7. Load Regulation versus Ambient Temperature

S-L2980Axx



8. Threshold Voltage of ON/OFF Pin versus Input Voltage

S-L2980A15

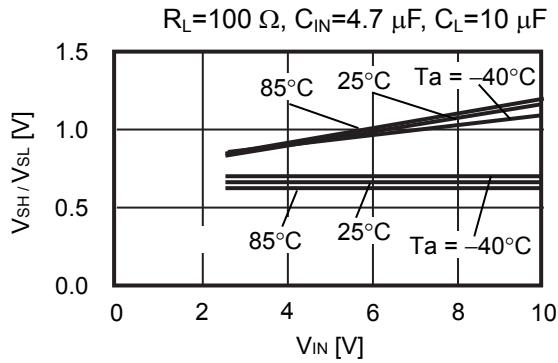

9. Current Consumption versus Input Voltage

S-L2980A15

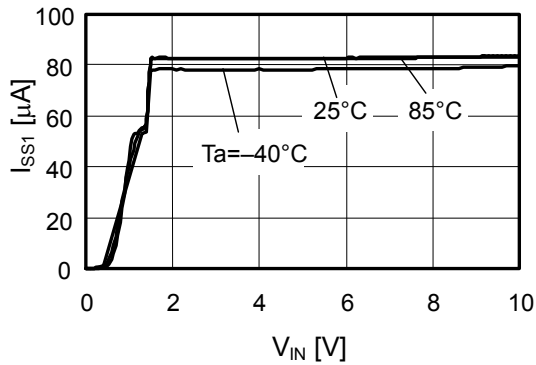

S-L2980A30

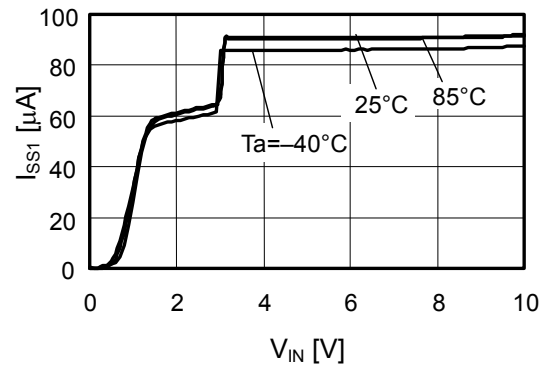

S-L2980A50

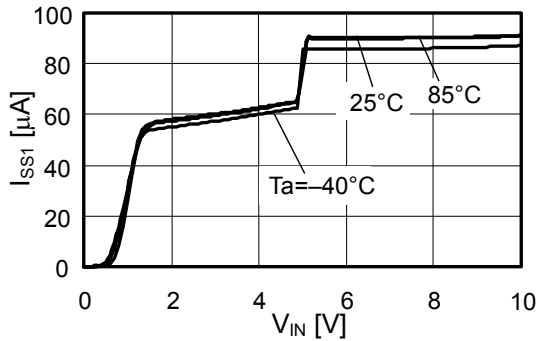

10. Ripple Rejection

S-L2980A30 (Ta=25°C)



S-L2980A50 (Ta=25°C)

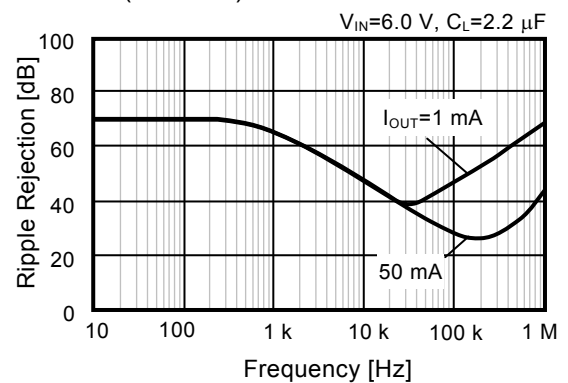

■ **Reference Data**

1. Transient Response Characteristics (S-L2980A30MC, Typical data, Ta=25°C)

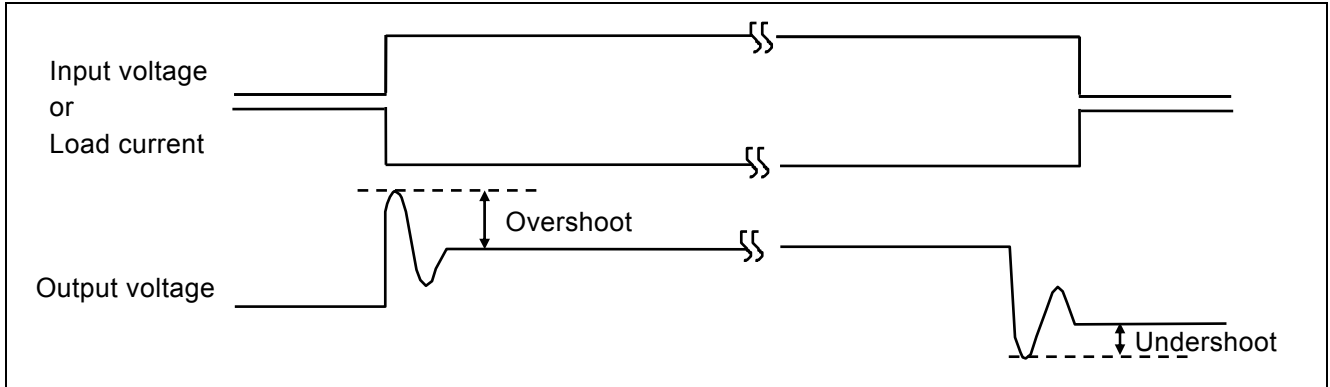

1-1. Power Source Fluctuation

Overshoot

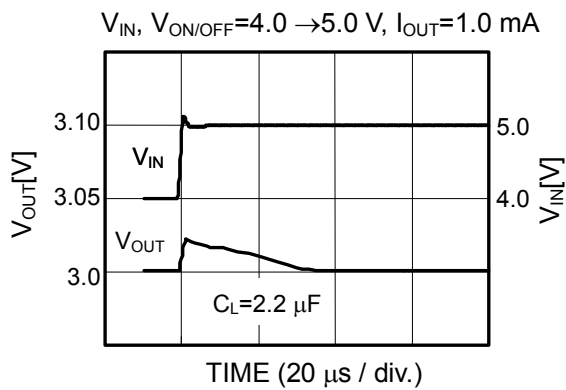

Undershoot

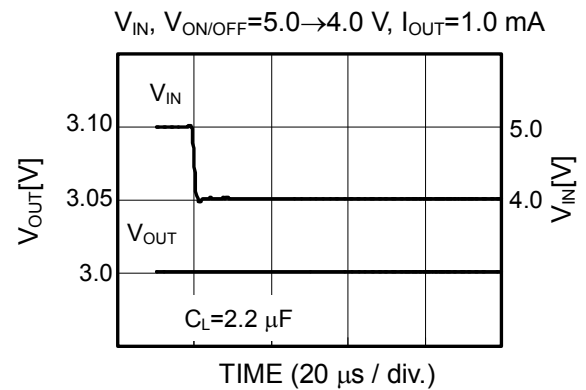

Overshoot

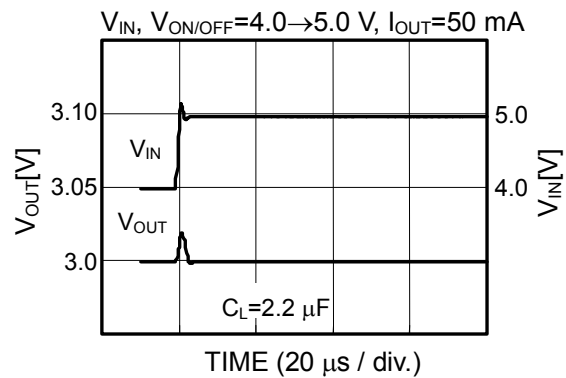

Undershoot

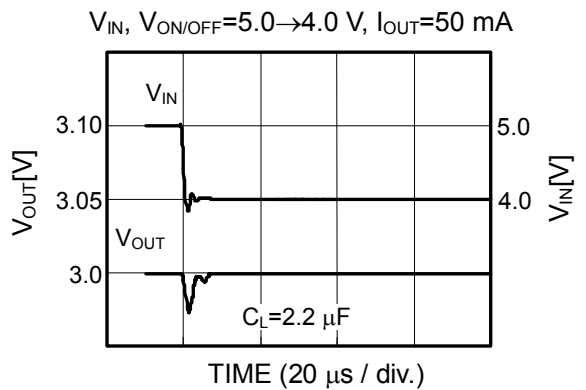

1-2. Load Fluctuation

Overshoot

$V_{IN}, V_{ON/OFF}=4.0\text{ V}, I_{OUT}=50\text{ mA}\rightarrow 1.0\text{ mA}$

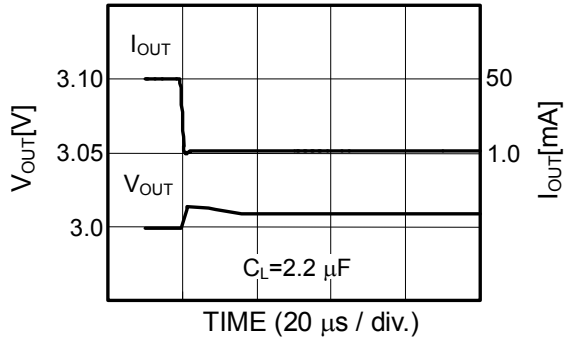

Undershoot

$V_{IN}, V_{ON/OFF}=4.0\text{ V}, I_{OUT}=1.0\text{ mA}\rightarrow 50\text{ mA}$

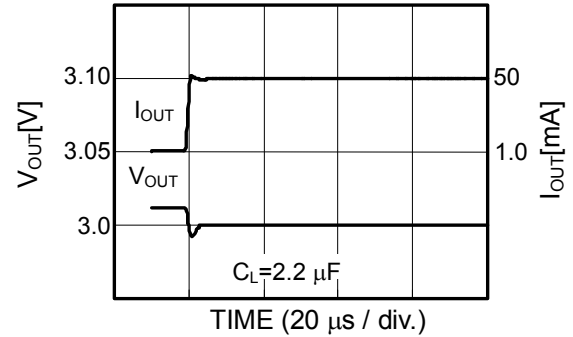

1-3. ON/OFF Switching (S-L2980A50MC, Typical data, $T_a=25^\circ\text{C}$)

Overshoot

$V_{IN}=6.0\text{ V}, R_L=5.0\text{ k}\Omega, C_L=2.2\ \mu\text{F}$



Undershoot

$V_{IN}=6.0\text{ V}, R_L=5.0\text{ k}\Omega, C_L=2.2\ \mu\text{F}$

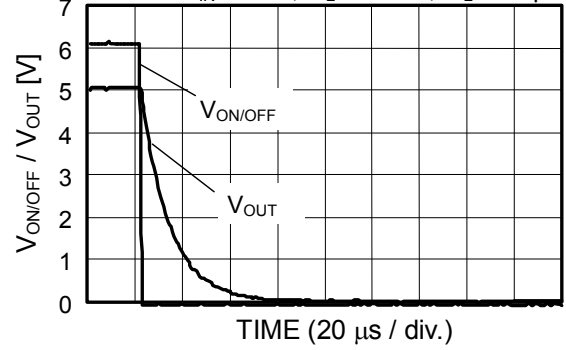



No. MP005-A-P-SD-1.3

TITLE	SOT235-A-PKG Dimensions
No.	MP005-A-P-SD-1.3
ANGLE	
UNIT	mm
ABLIC Inc.	



→ Feed direction

No. MP005-A-C-SD-2.1

TITLE	SOT235-A-Carrier Tape
No.	MP005-A-C-SD-2.1
ANGLE	
UNIT	mm
ABLIC Inc.	



Enlarged drawing in the central part



No. MP005-A-R-SD-1.1

TITLE	SOT235-A-Reel		
No.	MP005-A-R-SD-1.1		
ANGLE		QTY.	3,000
UNIT	mm		
ABLIC Inc.			

Disclaimers (Handling Precautions)

1. All the information described herein (product data, specifications, figures, tables, programs, algorithms and application circuit examples, etc.) is current as of publishing date of this document and is subject to change without notice.
2. The circuit examples and the usages described herein are for reference only, and do not guarantee the success of any specific mass-production design.
ABLIC Inc. is not liable for any losses, damages, claims or demands caused by the reasons other than the products described herein (hereinafter "the products") or infringement of third-party intellectual property right and any other right due to the use of the information described herein.
3. ABLIC Inc. is not liable for any losses, damages, claims or demands caused by the incorrect information described herein.
4. Be careful to use the products within their ranges described herein. Pay special attention for use to the absolute maximum ratings, operation voltage range and electrical characteristics, etc.
ABLIC Inc. is not liable for any losses, damages, claims or demands caused by failures and / or accidents, etc. due to the use of the products outside their specified ranges.
5. Before using the products, confirm their applications, and the laws and regulations of the region or country where they are used and verify suitability, safety and other factors for the intended use.
6. When exporting the products, comply with the Foreign Exchange and Foreign Trade Act and all other export-related laws, and follow the required procedures.
7. The products are strictly prohibited from using, providing or exporting for the purposes of the development of weapons of mass destruction or military use. ABLIC Inc. is not liable for any losses, damages, claims or demands caused by any provision or export to the person or entity who intends to develop, manufacture, use or store nuclear, biological or chemical weapons or missiles, or use any other military purposes.
8. The products are not designed to be used as part of any device or equipment that may affect the human body, human life, or assets (such as medical equipment, disaster prevention systems, security systems, combustion control systems, infrastructure control systems, vehicle equipment, traffic systems, in-vehicle equipment, aviation equipment, aerospace equipment, and nuclear-related equipment), excluding when specified for in-vehicle use or other uses by ABLIC, Inc. Do not apply the products to the above listed devices and equipments.
ABLIC Inc. is not liable for any losses, damages, claims or demands caused by unauthorized or unspecified use of the products.
9. In general, semiconductor products may fail or malfunction with some probability. The user of the products should therefore take responsibility to give thorough consideration to safety design including redundancy, fire spread prevention measures, and malfunction prevention to prevent accidents causing injury or death, fires and social damage, etc. that may ensue from the products' failure or malfunction.
The entire system in which the products are used must be sufficiently evaluated and judged whether the products are allowed to apply for the system on customer's own responsibility.
10. The products are not designed to be radiation-proof. The necessary radiation measures should be taken in the product design by the customer depending on the intended use.
11. The products do not affect human health under normal use. However, they contain chemical substances and heavy metals and should therefore not be put in the mouth. The fracture surfaces of wafers and chips may be sharp. Be careful when handling these with the bare hands to prevent injuries, etc.
12. When disposing of the products, comply with the laws and ordinances of the country or region where they are used.
13. The information described herein contains copyright information and know-how of ABLIC Inc. The information described herein does not convey any license under any intellectual property rights or any other rights belonging to ABLIC Inc. or a third party. Reproduction or copying of the information from this document or any part of this document described herein for the purpose of disclosing it to a third-party is strictly prohibited without the express permission of ABLIC Inc.
14. For more details on the information described herein or any other questions, please contact ABLIC Inc.'s sales representative.
15. This Disclaimers have been delivered in a text using the Japanese language, which text, despite any translations into the English language and the Chinese language, shall be controlling.

2.4-2019.07

Mouser Electronics

Authorized Distributor

Click to View Pricing, Inventory, Delivery & Lifecycle Information:

ABLIC:

[S-L2980A40MC-TF-G](#) [S-L2980A28MC-TF-G](#) [S-L2980A18MC-TF-G](#) [S-L2980A33MC-TF-G](#) [S-L2980A27MC-TF-G](#) [S-](#)
[L2980A25MC-TF-G](#) [S-L2980A31MC-TF-G](#) [S-L2980A30MC-TF-G](#) [S-L2980A15MC-TF-G](#) [S-L2980A16MC-TF-G](#) [S-](#)
[L2980A19MC-TF-G](#) [S-L2980A20MC-TF-G](#) [S-L2980A21MC-TF-G](#) [S-L2980A22MC-TF-G](#) [S-L2980A23MC-TF-G](#) [S-](#)
[L2980A24MC-TF-G](#) [S-L2980A26MC-TF-G](#) [S-L2980A29MC-TF-G](#) [S-L2980A32MC-TF-G](#) [S-L2980A34MC-TF-G](#) [S-](#)
[L2980A35MC-TF-G](#) [S-L2980A36MC-TF-G](#) [S-L2980A37MC-TF-G](#) [S-L2980A39MC-TF-G](#) [S-L2980A41MC-TF-G](#) [S-](#)
[L2980A42MC-TF-G](#) [S-L2980A43MC-TF-G](#) [S-L2980A44MC-TF-G](#) [S-L2980A45MC-TF-G](#) [S-L2980A46MC-TF-G](#) [S-](#)
[L2980A47MC-TF-G](#) [S-L2980A48MC-TF-G](#) [S-L2980A49MC-TF-G](#) [S-L2980A51MC-TF-G](#) [S-L2980A52MC-TF-G](#) [S-](#)
[L2980A53MC-TF-G](#) [S-L2980A54MC-TF-G](#) [S-L2980A55MC-TF-G](#) [S-L2980A56MC-TF-G](#) [S-L2980A57MC-TF-G](#) [S-](#)
[L2980A58MC-TF-G](#) [S-L2980A59MC-TF-G](#) [S-L2980A60MC-TF-G](#) [S-L2980A50MC-TF-G](#) [S-L2980A38MC-TF-G](#) [S-](#)
[L2980A17MC-TF-G](#) [S-L2980A18MC-TF-U](#) [S-L2980A28MC-TF-U](#) [S-L2980A33MC-TF-U](#) [S-L2980A25MC-TF-U](#) [S-](#)
[L2980A50MC-TF-U](#) [S-L2980A27MC-TF-U](#) [S-L2980A23MC-TF-U](#) [S-L2980A21MC-TF-U](#) [S-L2980A24MC-TF-U](#) [S-](#)
[L2980A22MC-TF-U](#) [S-L2980A29MC-TF-U](#) [S-L2980A52MC-TF-U](#) [S-L2980A16MC-TF-U](#) [S-L2980A19MC-TF-U](#) [S-](#)
[L2980A15MC-TF-U](#) [S-L2980A20MC-TF-U](#) [S-L2980A57MC-TF-U](#) [S-L2980A41MC-TF-U](#) [S-L2980A38MC-TF-U](#) [S-](#)
[L2980A55MC-TF-U](#) [S-L2980A60MC-TF-U](#) [S-L2980A17MC-TF-U](#) [S-L2980A31MC-TF-U](#) [S-L2980A47MC-TF-U](#) [S-](#)
[L2980A54MC-TF-U](#) [S-L2980A45MC-TF-U](#) [S-L2980A26MC-TF-U](#) [S-L2980A56MC-TF-U](#) [S-L2980A53MC-TF-U](#) [S-](#)
[L2980A30MC-TF-U](#) [S-L2980A48MC-TF-U](#) [S-L2980A37MC-TF-U](#) [S-L2980A35MC-TF-U](#) [S-L2980A40MC-TF-U](#) [S-](#)
[L2980A58MC-TF-U](#) [S-L2980A49MC-TF-U](#) [S-L2980A59MC-TF-U](#) [S-L2980A36MC-TF-U](#) [S-L2980A43MC-TF-U](#) [S-](#)
[L2980A39MC-TF-U](#) [S-L2980A42MC-TF-U](#) [S-L2980A34MC-TF-U](#) [S-L2980A44MC-TF-U](#) [S-L2980A51MC-TF-U](#) [S-](#)
[L2980A32MC-TF-U](#) [S-L2980A46MC-TF-U](#)



Компания «ЭлектроПласт» предлагает заключение долгосрочных отношений при поставках импортных электронных компонентов на взаимовыгодных условиях!

Наши преимущества:

- Оперативные поставки широкого спектра электронных компонентов отечественного и импортного производства напрямую от производителей и с крупнейших мировых складов;
- Поставка более 17-ти миллионов наименований электронных компонентов;
- Поставка сложных, дефицитных, либо снятых с производства позиций;
- Оперативные сроки поставки под заказ (от 5 рабочих дней);
- Экспресс доставка в любую точку России;
- Техническая поддержка проекта, помощь в подборе аналогов, поставка прототипов;
- Система менеджмента качества сертифицирована по Международному стандарту ISO 9001;
- Лицензия ФСБ на осуществление работ с использованием сведений, составляющих государственную тайну;
- Поставка специализированных компонентов (Xilinx, Altera, Analog Devices, Intersil, Interpoint, Microsemi, Aeroflex, Peregrine, Syfer, Eurofarad, Texas Instrument, Miteq, Cobham, E2V, MA-COM, Hittite, Mini-Circuits, General Dynamics и др.);

Помимо этого, одним из направлений компании «ЭлектроПласт» является направление «Источники питания». Мы предлагаем Вам помощь Конструкторского отдела:

- Подбор оптимального решения, техническое обоснование при выборе компонента;
- Подбор аналогов;
- Консультации по применению компонента;
- Поставка образцов и прототипов;
- Техническая поддержка проекта;
- Защита от снятия компонента с производства.



Как с нами связаться

Телефон: 8 (812) 309 58 32 (многоканальный)

Факс: 8 (812) 320-02-42

Электронная почта: org@eplast1.ru

Адрес: 198099, г. Санкт-Петербург, ул. Калинина, дом 2, корпус 4, литера А.