



VITA 62 Power Supply

VIT028wxx600yzzz

VITA 62 DC-DC Converter

Features & Benefits

- Open VPX – VITA 62
- 18 – 50V input voltage range
- 600W output power
- 3U Open VPX power supply
- Conduction cooled
- 6 outputs
- I²C™ monitoring and control
- Input voltage reverse-polarity protection
- Remote voltage sense: VS1, VS2, VS3
- Parallel operation capable with proprietary wireless current sharing
- Overcurrent, overvoltage and overtemperature protections
- IPC 610 class 3
- No aluminum electrolytic capacitors
- Enable, inhibit, system reset and power fail controls
- Military standard compliance: ^[a]
 - MIL-STD-704F
 - MIL-STD-461F
 - MIL-STD-810G
 - MIL-STD-1275D Normal Surges and Spikes
 - RTCA/DO-160G

Product Description

The Vicor VITA 62 power supply is a COTs power supply that is designed for 3U Open VPX systems. The module utilizes Vicor proprietary technology to enable high efficiency and power density for this highly rugged, conduction-cooled model.

Up to four power supplies can be paralleled to increase output power capability of VS1, VS2, VS3 outputs with proprietary wireless current sharing. Conventional current-share pins are eliminated. Current share accuracy is $\pm 1A$.

Typical Applications

- VPX power modules
- Avionics
- Shipborne electronics

^[a] See detailed specifications

Note: Product images may not highlight current product markings.

Connector Pin Configuration

ROWS	POWER			SIGNAL								POWER					
				1	2	3	4	5	6	7	8						
D	P1	P2	LP1										P3	P4	P5	LP2	P6
C																	
B																	
A																	

3U P0 Connector

Note: See mechanical drawing on page 17 for connector information.

Connector Pin Descriptions

Pin	Function / Name	Description
P1	-DC_IN	V _{IN-}
P2	+DC_IN	V _{IN+}
LP1	CHASSIS	Chassis
A1	No Connection	
B1	No Connection	
C1	No Connection	
D1	No Connection	
A2	No Connection	
B2	FAIL*	When any of the output is not within specification, FAIL* signal will be driven low to indicate a failure
C2	INHIBIT*	Input control signal as defined in VITA 62, referenced to SIGNAL_RETURN
D2	ENABLE*	Input control signal as defined in VITA 62, referenced to SIGNAL_RETURN
A3	No Connection	
B3	VAUX3	+12V auxiliary output voltage
C3	No Connection	
D3	No Connection	
A4, B4, C4, D4	VAUX2	+3.3V auxiliary output voltage
A5	*GA0	Geographical address defined by VITA 46.11
B5	*GA1	Geographical address defined by VITA 46.11
C5	SM0 (I ² C Clock)	Primary I ² C™ communication bus
D5	SM1 (I ² C Data)	
A6	I ² C Clock	Redundant I ² C communication bus
B6	I ² C Data	
C6	VAUX1	-12V auxiliary output voltage
D6	SYS_RESET*	System Reset is actively low. It will float when all outputs are within specification
A7	No Connection	
B7	No Connection	
C7	No Connection	
D7	SIGNAL_RETURN	Ground pin for control signals
A8	+12V _{SENSE}	VS1 sense, should be connected at point-of-load or on the backplane to corresponding voltage output
B8	+3.3V _{SENSE}	VS2 sense, should be connected at point-of-load or on the backplane to corresponding voltage output
C8	+5V _{SENSE}	VS3 sense, should be connected at point-of-load or on the backplane to corresponding voltage output
D8	SENSE_RETURN	Should be connected to POWER_RETURN either remotely or at the connector
P3	VS3	+5V main output
P4, P5	POWER_RETURN	Common output voltage return pin
LP2	VS2	+3.3V main output
P6	VS1	+12V main output

Part Ordering Information

Product Function	Nominal Input Voltage	Grade	Package Size	Output Power	Conformal Coated	Factory-Configured Options
VIT	028	w	xx	600	y	zzz
VIT = VITA62	028 = 28V _{DC}	H = -40 to 85°C	3U	600 = 600W	C = Coated D = C+Au-plated Connector	002 = Parallelable

Absolute Maximum Ratings

The absolute maximum ratings below are stress ratings only. Operation at or beyond these maximum ratings can cause permanent damage to the device.

Parameter	Comments	Min	Max	Unit
Total Output Power	Combined outputs for all rails		600 ^[b]	W
Input Voltage	+IN to -IN	-0.5	50	V
Operating Temperature	Measured at card edge	-40	85	°C
Storage Temperature		-40	125	
Isolation Voltage IN to OUT			500	V _{DC}
Isolation Voltage IN to CASE			500	V _{DC}
Isolation Voltage OUT to CASE			100	V

^[b] Max aggregate power at 85°C wedge-lock is 450W.

Electrical Characteristics

All data at nominal line and nominal load unless otherwise specified.

Attribute	Symbol	Conditions / Notes	Min	Typ	Max	Unit
Overall System Characteristics						
System Efficiency		Nominal line, 20% aggregate loads		71		%
		Nominal line, 50% aggregate loads		84.8		
		Nominal line, 100% aggregate loads		87.5		
Power Input Characteristics						
Operating Input Voltage Range	V_{IN}		18	28	50	V
Input Current (No Load)	I_{IN-NL}	28V Input, enable asserted, inhibit de-asserted		0.43	0.60	A
Inrush Current	I_{INRUSH}	Peak no load, nominal line, high line; see Figures 22, 23		400	830	A
Input Undervoltage Protection Threshold	V_{UV-IN}	1ms response time			17.5	V
Input Overvoltage Protection Threshold	V_{OV-IN}	1ms response time	50.5			V
Power On to +3.3V _{AUX} Output Delay		If EN* is tied to signal ground	200	250	400	ms
Main Outputs						
VS1: +12V Output						
Output Voltage Set Point ^[c]		Standalone	11.90	12	12.1	V
		Parallel, droop share	11.80		12.1	
Output Regulation Over Line & Load		Standalone		100	200	mV
		Parallel		150	250	
Output Voltage Ripple / Noise		Nominal line from 2A load to full load			120	mV _{p-p}
Output Overcurrent Protection	$I_{OC-S-VS1}$	2Hz filter on OCP			45	A
Output Overvoltage Protection	$V_{OV-S-VS1}$	2Hz filter on OVP	12.6			V
Output Undervoltage Protection	$V_{UV-S-VS1}$	2Hz filter on UVP			11.4	V
Rated Output Current	I_{R-VS1}				40	A
Output Power limit	$P_{LIM-F-VS1}$	1ms response time; power calculation includes transmission voltage drop; enabled 5ms after voltage output is enabled			480	W
Fast Overcurrent Protection Limit	$I_{OC-F-VS1}$	1ms response time; enabled 5ms after voltage output is enabled	40	45	52	A
Maximum Operating Transmission Voltage Drop	V_{TD-VS1}				0.6	V
Maximum Output Capacitance	C_{O-VS1}				9	mF
Soft-Start Ramp Time	t_{SS-VS1}	All full load with max C_{O-VS1}	5			ms

Electrical Characteristics (Cont.)

All data at nominal line and nominal load unless otherwise specified.

Attribute	Symbol	Conditions / Notes	Min	Typ	Max	Unit
Main Outputs (Cont.)						
VS3: +5V Output						
Output Voltage Set Point ^[c]		Standalone	4.95	5	5.05	V
		Parallel, droop share	4.9		5.1	
Output Regulation Over Line & Load		Standalone		50	100	mV
		Parallel		100	150	
Output Voltage Ripple / Noise		Nominal line over load range, 20MHz BW; measured with 1µF and 10µF ceramic capacitor			50	mV _{p-p}
Output Overcurrent Protection	I _{OC-S-VS3}	2Hz filter on OCP	30	32		A
Output Overvoltage Protection	V _{OV-S-VS3}	2Hz filter on OVP	5.15			V
Output Undervoltage Protection	V _{UV-S-VS3}	2Hz filter on UVP			4.9	V
Rated Output Current	I _{R-VS3}				30	A
Output Power limit	P _{LIM-F-VS3}	1ms response time; power calculation includes remote-sense voltage drop; enabled 5ms after voltage output is enabled			150	W
Fast Overcurrent Protection Limit	I _{OC-F-VS3}	1ms response time; enabled 5ms after voltage output is enabled	30	32	35	A
Maximum Operating Transmission Voltage Drop	V _{TD-VS3}				0.6	V
Maximum Output Capacitance	C _{O-VS3}				9	mF
Soft-Start Ramp Time	t _{SS-VS3}	All full load with max C _{O-VS3}	5			ms
VS2: +3.3V Output						
Output Voltage Set Point ^[c]		Standalone	3.25	3.35	3.45	V
		Parallel, droop share				
Output Regulation Over Line & Load		Standalone		50	100	mV
		Parallel		100	150	
Output Voltage Ripple / Noise		Nominal line over load range, 20MHz BW; measured with 1µF and 10µF ceramic capacitor			50	mV _{p-p}
Output Overcurrent Protection	I _{OC-S-VS2}	2Hz filter on OCP			35	A
Output Overvoltage Protection	V _{OV-S-VS2}	2Hz filter on OVP	3.5			V
Output Undervoltage Protection	V _{UV-S-VS2}	2Hz filter on UVP			3.2	V
Rated Output Current	I _{R-VS2}				20	A
Output Power limit	P _{LIM-F-VS2}	1ms response time; power calculation includes remote-sense voltage drop; enabled 5ms after voltage output is enabled			82	W
Fast Overcurrent Protection Limit	I _{OC-F-VS2}	1ms response time; enabled 50ms after voltage output is enabled	24	30	40	A
Maximum Operating Transmission Voltage Drop	V _{TD-VS2}				0.6	V
Maximum Output Capacitance	C _{O-VS2}				9	mF
Soft-Start Ramp Time	t _{SS-VS2}	All full load with max C _{O-VS3}			50	ms

^[c] 50% load.

Electrical Characteristics (Cont.)

All data at nominal line and nominal load unless otherwise specified.

Attribute	Symbol	Conditions / Notes	Min	Typ	Max	Unit
Auxiliary Outputs						
VAUX1: -12V Output						
Output Voltage Set Point			11.9	12	12.1	V
Output Regulation Over Line & Load				50	100	mV
Output Voltage Ripple / Noise		Nominal line over load range, 20MHz BW; measured with 1µF and 10µF ceramic capacitor			120	mV _{p-p}
Output Overcurrent Protection	I _{OC-S-VAUX1}	2Hz filter on OCP			2	A
Output Overvoltage Protection	V _{OV-S-VAUX1}	2Hz filter on OVP	12.2			V
Output Undervoltage Protection	V _{UV-S-VAUX1}	2Hz filter on UVP			11.8	V
Rated Output Current	I _{R-VAUX1}				1	A
Fast Overcurrent Protection Limit	I _{OC-F-VAUX1}	1ms response time; enabled 5ms after voltage output is enabled	2			A
Maximum Output Capacitance	C _{O-VAUX1}				2	mF
Soft-Start Ramp Time	t _{SS-VAUX1}	All full load with max C _{O-VAUX1}			50	ms
VAUX3: +12V Output						
Output Voltage Set Point			11.5	12	12.6	V
Output Regulation Over Line & Load					1	V
Output Voltage Ripple / Noise		Output derived directly from VS1,+12V Main Output; output ripple and noise depends on VS1 load			180	mV _{p-p}
Output Overcurrent Protection	I _{OC-S-VAUX3}	2Hz filter on OCP			2	A
Output Overvoltage Protection	V _{OV-S-VAUX3}	2Hz filter on OVP	12.2			V
Output Undervoltage Protection	V _{UV-S-VAUX3}	2Hz filter on UVP			11.5	V
Rated Output Current	I _{R-VAUX3}				1	A
Fast Overcurrent Protection Limit	I _{OC-F-VAUX3}	1ms response time; enabled 5ms after voltage output is enabled	2			A
Maximum Output Capacitance	C _{O-VAUX3}				2	mF
Soft-Start Ramp Time	t _{SS-VAUX3}	All full load with max C _{O-VAUX3}			5	ms
VAUX2: +3.3V Output						
Output Voltage Set Point			3.2	3.3	3.42	V
Output Regulation Over Line & Load				100	150	mV
Output Voltage Ripple / Noise		Nominal line over load range, 20MHz BW; measured with 1µF and 10µF ceramic capacitor			50	mV _{p-p}
Output Overcurrent Protection	I _{OC-S-VAUX2}	2Hz filter on OCP	7	8	12	A
Output Overvoltage Protection	V _{OV-S-VAUX2}	2Hz filter on OVP	3.45			V
Output Undervoltage Protection	V _{UV-S-VAUX2}	2Hz filter on UVP			3.15	V
Rated Output Current	I _{R-VAUX2}				6	A
Fast Overcurrent Protection Limit	I _{OC-F-VAUX2}	1ms response time; enabled 5ms after voltage output is enabled	9	12		A
Maximum Output Capacitance	C _{O-VAUX2}				5	mF
Soft-Start Ramp Time	t _{SS-VAUX2}	All full load with max C _{O-VAUX2}			5	ms

Operating Area

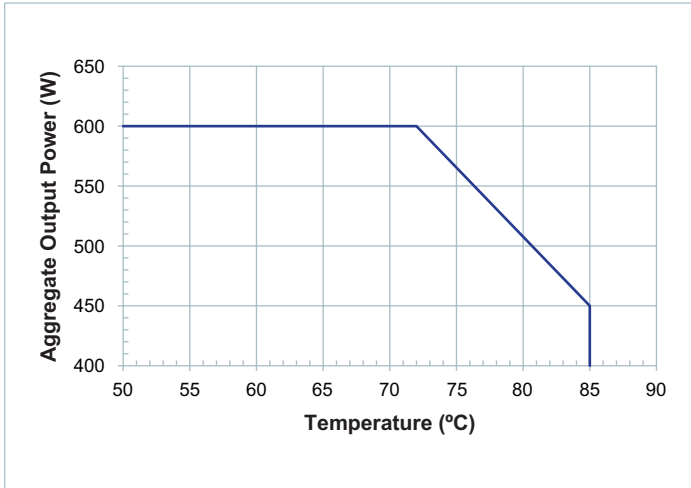

Figure 1 — Thermal specified operating area: aggregate power vs. rail temperature for power-limited operation

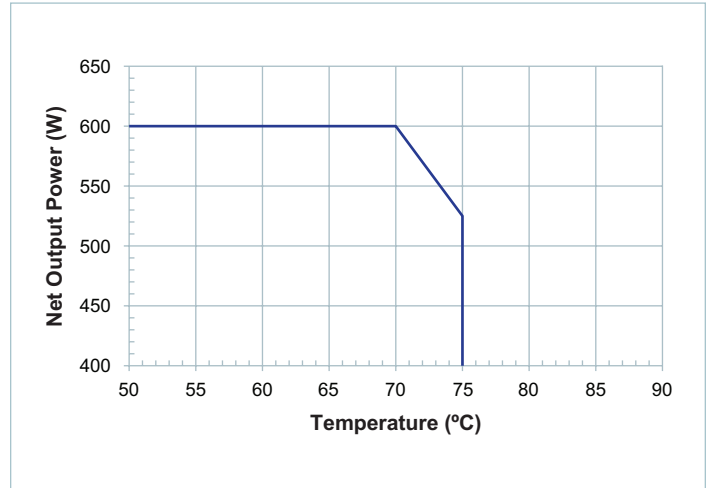

Figure 2 — Thermal specified operating area: worst-case loading vs. rail temp for power-limited operation

Load configuration:

VS1 @ 40A,
 VAUX1 @ 1A,
 VAUX2 @ 6A,
 VAUX3 @ 1A } Constant 525W

Remaining outputs loaded on aggregate to achieve 600W combined output below 70°C rail temperature

Signal Characteristics

All of the following plots are at nominal line and 600W aggregate load unless otherwise noted.

EN*: Enable*									
<ul style="list-style-type: none"> The EN* pin or control register bit enables and disables the +3.3V AUX output of the power supply. The EN* pin has an internal pull-up to V_{CC} and is referenced to the Signal Return pin of the power supply. 									
Signal Type	State	Attribute	Symbol	Conditions / Notes	Min	Typ	Max	Unit	
Digital Input	Any	EN* Enable Threshold	V _{ENABLE-EN}				0.8	V	
		EN* Disable Threshold	V _{ENABLE-DIS}		2.0			V	
		Internally Generated V _{CC}	V _{CC}		3.21	3.30	3.39	V	
		EN* Internal Pull-Up Resistance to V _{CC}	R _{ENABLE-INT}		49	51	52	kΩ	
		EN* Enable Debounce Delay	t _{D-EN-E}		40	100	150	ms	
		EN* Disable Debounce Delay	t _{D-EN-D}		40	100	150	ms	

IN*: Inhibit*									
<ul style="list-style-type: none"> The IN* pin enables and disables all outputs except +3.3V_{AUX} if V_{ENABLE-EN} threshold has been met. The IN* pin has an internal pull up to V_{CC} and is referenced to the Signal Return pin of the power supply. 									
Signal Type	State	Attribute	Symbol	Conditions / Notes	Min	Typ	Max	Unit	
Digital Input	Any	IN* Enable Threshold	V _{INHIBIT-EN}	Status register bit 4 should be 0 (default) for digital input control line to have priority	2.0			V	
		IN* Disable Threshold	V _{INHIBIT-DIS}				0.8	V	
		Internally Generated V _{CC}	V _{CC}		3.21	3.30	3.39	V	
		IN* Internal Pull-Up Resistance to V _{CC}	R _{DISABLE-INT}		49	51	52	kΩ	
		IN* Enable Debounce Delay after EN*	t _{D-IN-E}		300	500	700	ms	
		IN* Disable Debounce Delay	t _{D-IN-D}		10	40	100	ms	
		Lockout Delay Between Consecutive IN* Enables	t _{D-IN-L}		100		300	ms	

Signal Characteristics (Cont.)

All of the following plots are at nominal line and 600W aggregate load unless otherwise noted.

GA0*, GA1*: Global Address								
<ul style="list-style-type: none"> The GA0* and GA1* pins sets the I²C™ address of the power supply. Global address is set at start up and cannot be changed without a power cycle. The GA0* and GA1* pins have an internal pull-up to V_{CC} and is referenced to the Signal Return pin of the power supply. 								
Signal Type	State	Attribute	Symbol	Conditions / Notes	Min	Typ	Max	Unit
Digital Input	Start Up	Address Pins Low Threshold	V _{ADDR-L}				0.8	V
		Address Pins High Threshold	V _{ADDR-H}		2.0			V
		Internally Generated V _{CC}	V _{CC}		3.21	3.30	3.39	V
		EN* Internal Pull-Up Resistance to V _{CC}	R _{ADDR-INT}		49	51	52	kΩ
		Address Pins Debounce Delay	t _{D-ADDR}		5		25	ms

FAIL*, SYSRESET* & LED								
<ul style="list-style-type: none"> The power supply has one two color LED located on the ejector edge of the power supply. The LED is either GREEN or RED depending on the state of operation. FAIL* and SYSRESET* lines are set with the LED. 								
Signal Type	State	Attribute	Symbol	Conditions / Notes	Min	Typ	Max	Unit
Outputs	Steady RED	SYSRESET*	V _{SYSRST}	Start up: input voltage operating threshold V _{UV-IN} < V _{IN} < V _{OV-IN} has been met; if steady RED persists for >100ms, a critical system fault has been detected during start up	0.0	0.1	0.8	V
		FAIL*	V _{FAIL}		0.0	0.1	0.8	V
	Blinking GREEN	SYSRESET*	V _{SYSRST}	>100ms after V _{UV-IN} < V _{IN} < V _{OV-IN} has been met; power supply is ready for use	2.0	3.2	3.4	V
		FAIL*	V _{FAIL}		2.0	3.2	3.4	V
	Steady GREEN	SYSRESET*	V _{SYSRST}	All outputs are OK and EN* is pulled low	2.0	3.2	3.4	V
		FAIL*	V _{FAIL}		2.0	3.2	3.4	V
	Blinking RED	SYSRESET*	V _{SYSRST}	Power supply has encountered a OT, OV, UV, OC or critical system failure during operating	2.0	3.2	3.4	V
		FAIL*	V _{FAIL}		0.0	0.1	0.8	V

Application Characteristics

All of the following plots are at nominal line and 600W aggregate load unless otherwise noted.

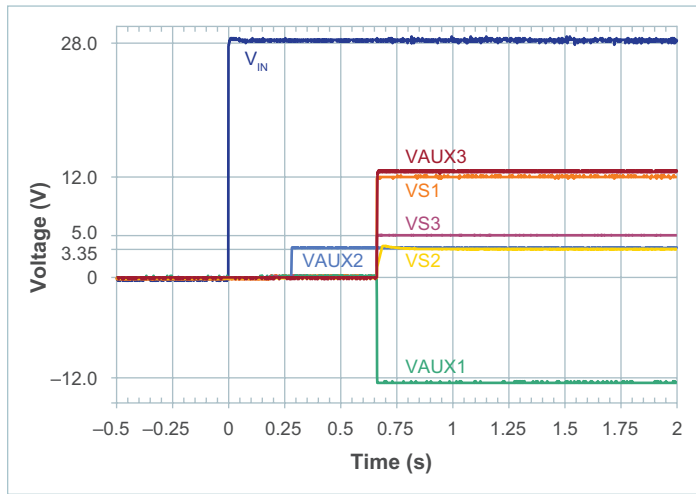

Figure 3 — Delay between application of input power and all outputs available; ENABLE tied to signal ground and INHIBIT left floating

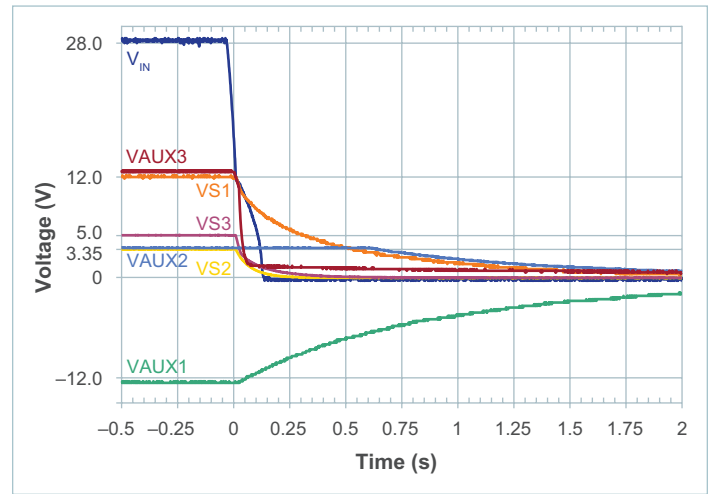

Figure 4 — Delay between removal of input power and all outputs decaying; ENABLE tied to signal ground and INHIBIT left floating

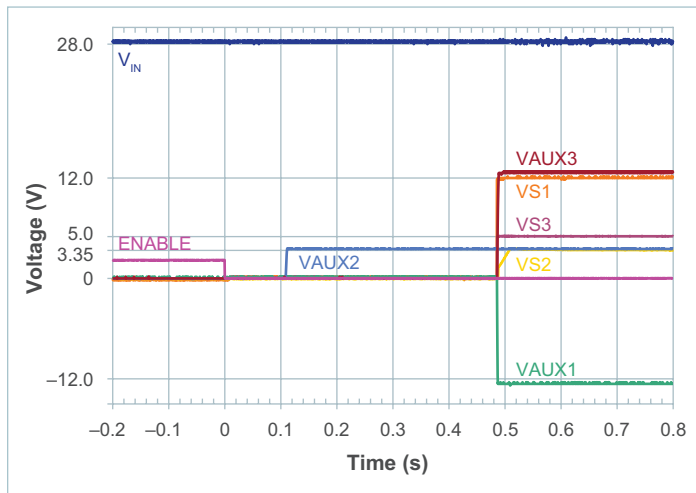

Figure 5 — Delay between ENABLE line transitioning from floating to signal ground and all outputs becoming available; INHIBIT left floating

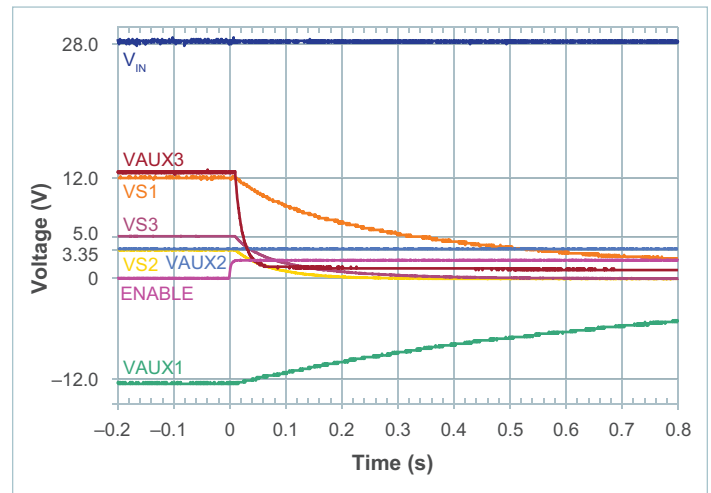

Figure 6 — Delay between ENABLE line transitioning from signal ground to floating and all outputs decaying; INHIBIT left floating

Application Characteristics (Cont.)

All of the following plots are at nominal line and 600W aggregate load unless otherwise noted.

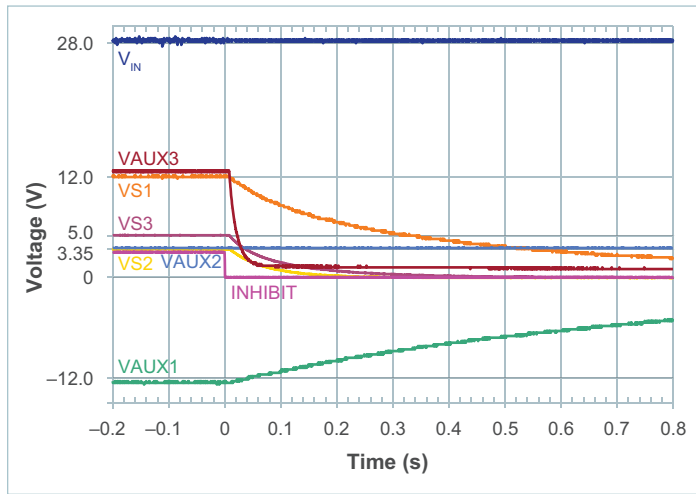

Figure 7 — Delay between INHIBIT line transitioning from floating to signal ground and corresponding outputs decaying; VAUX2 (+3.3V) remains on; ENABLE tied to signal ground

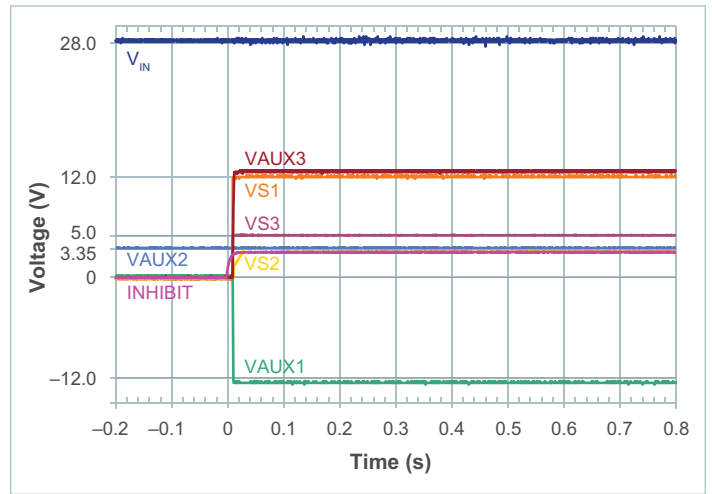

Figure 8 — Time delay between INHIBIT line transitioning from signal ground to floating and corresponding outputs becoming available; VAUX2 (+3.3V) remains on; ENABLE tied to signal ground

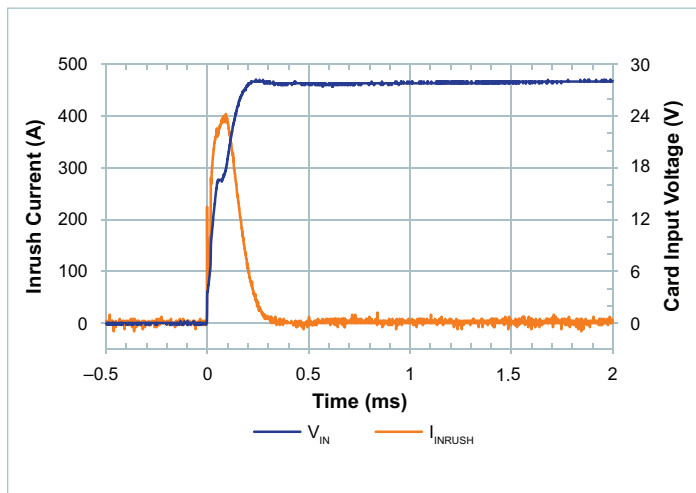

Figure 9 — Inrush current at nominal input voltage; CH1 – inrush current, 1mV/A; CH2 – card input voltage

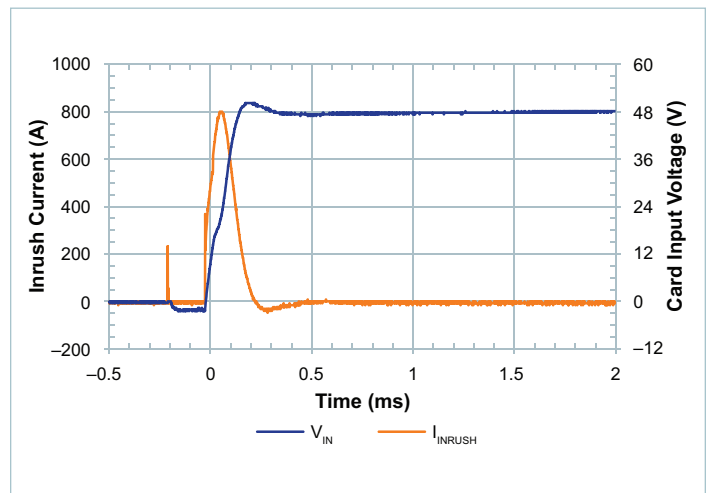

Figure 10 — Inrush current at max input voltage (45V); CH1 – inrush current, 1mV/A; CH2 – card input voltage

Application Characteristics (Cont.)

Load step response for all outputs being loaded from no load to 100% of their rated output simultaneously. All of the following plots are at nominal line and 600W aggregate load unless otherwise noted.

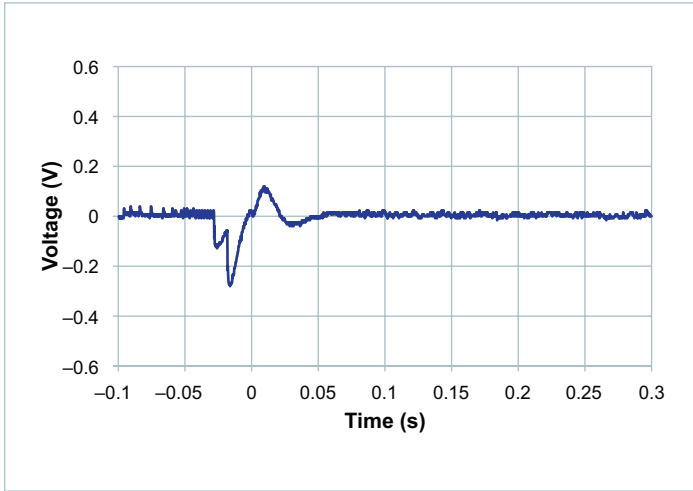

Figure 11 — Transient response of the VS1 (+12V) output with a load step of 0% (0A) to 100% (40A); AC coupled

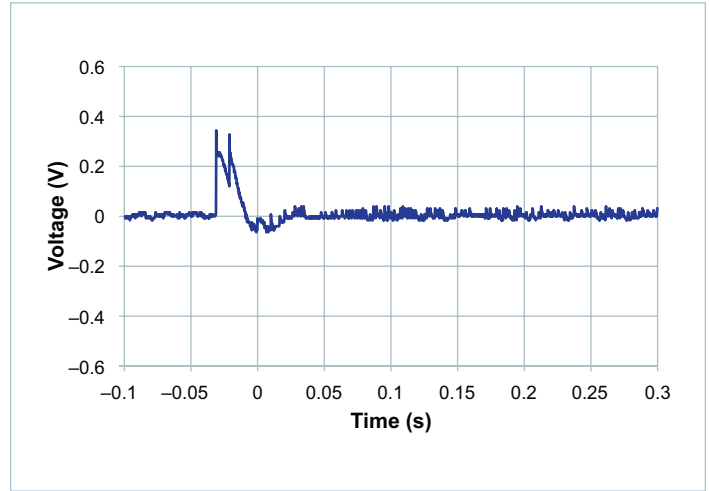

Figure 12 — Transient response of the VS1 (+12V) output with a load step of 100% (40A) to 0% (0A); AC coupled

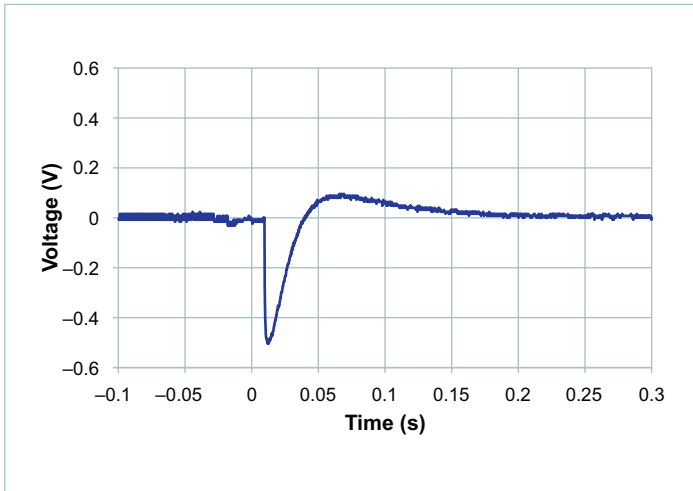

Figure 13 — Transient response of the VS3 (+5V) output with a load step of 0% (0A) to 100% (30A); AC coupled

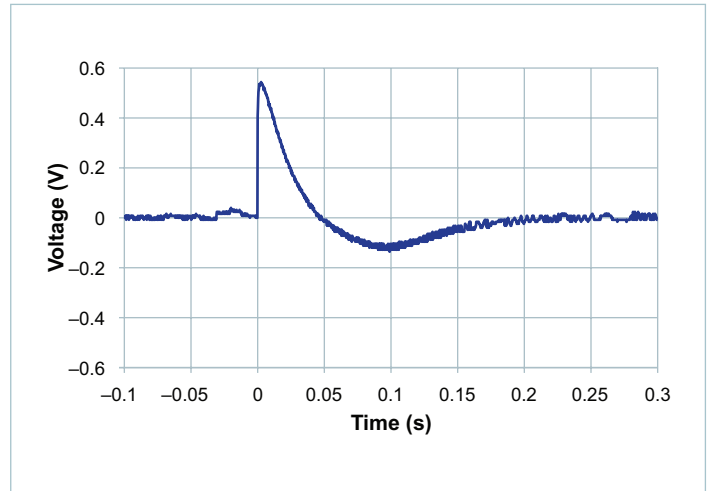

Figure 14 — Transient response of the VS3 (+5V) output with a load step of 100% (30A) to 0% (0A); AC coupled

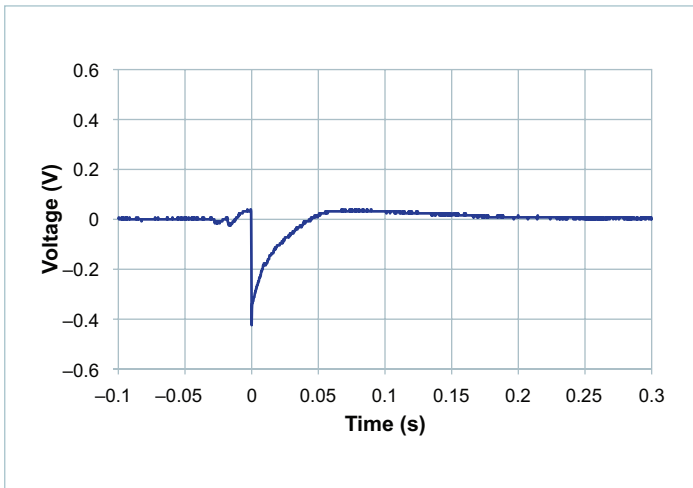

Figure 15 — Transient response of the VS2 (+3.3V) output with a load step of 0% (0A) to 100% (20A); AC coupled

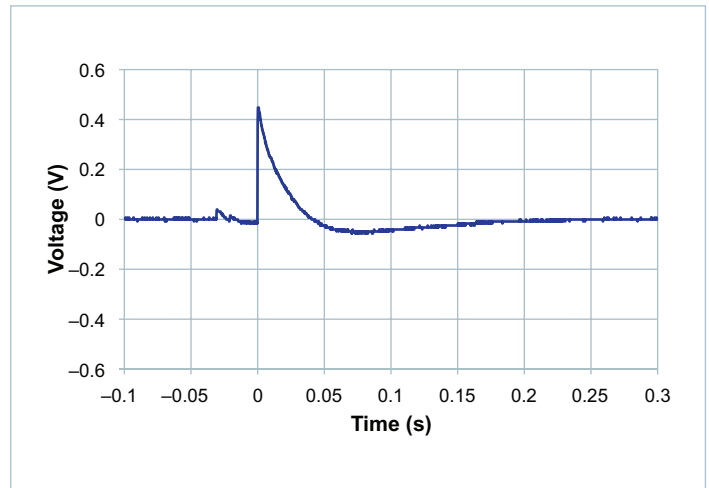

Figure 16 — Transient response of the VS2 (+3.3V) output with a load step of 100% (20A) to 0% (0A); AC coupled

Application Characteristics (Cont.)

Load step response for all outputs being unloaded from 100% of their rated output to to no load simultaneously.

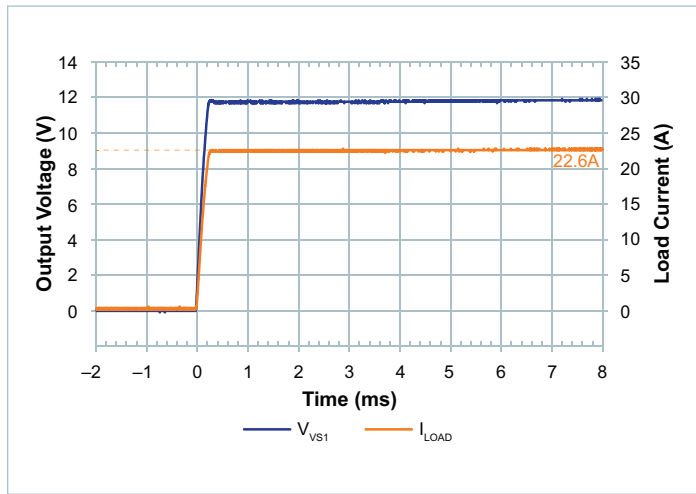

Figure 17 — Rise time of the VS1 (+12V) output with nominal load

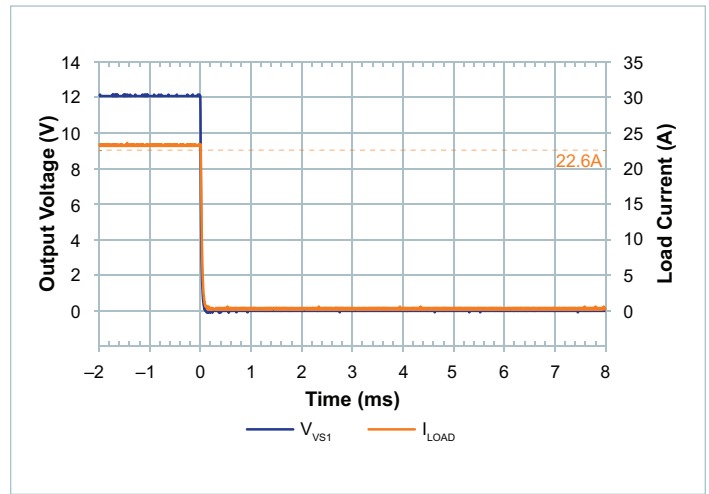

Figure 18 — Discharge time of the VS1 (+12V) output

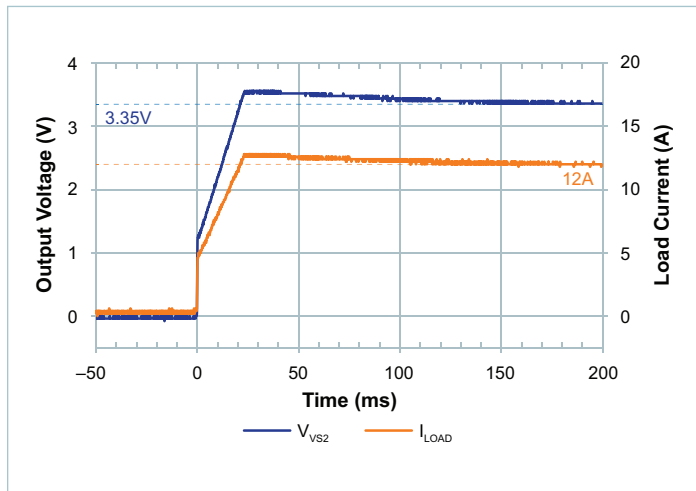

Figure 19 — Rise time of the VS2 (+3.3V) output with nominal load

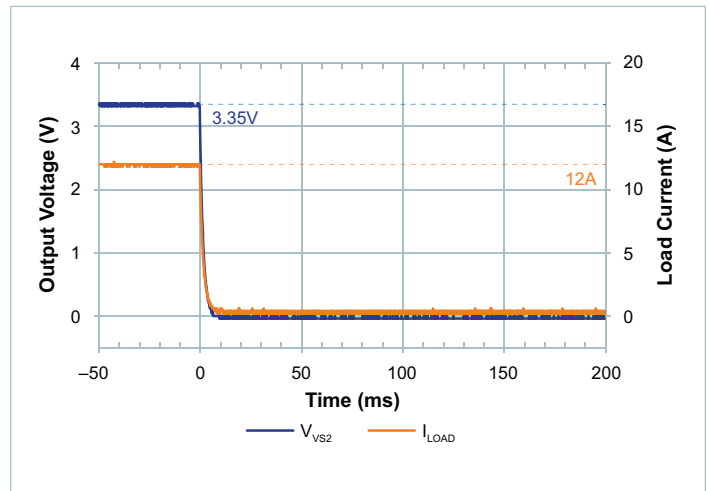

Figure 20 — Discharge time of the VS2 (+3.3V) output with nominal load

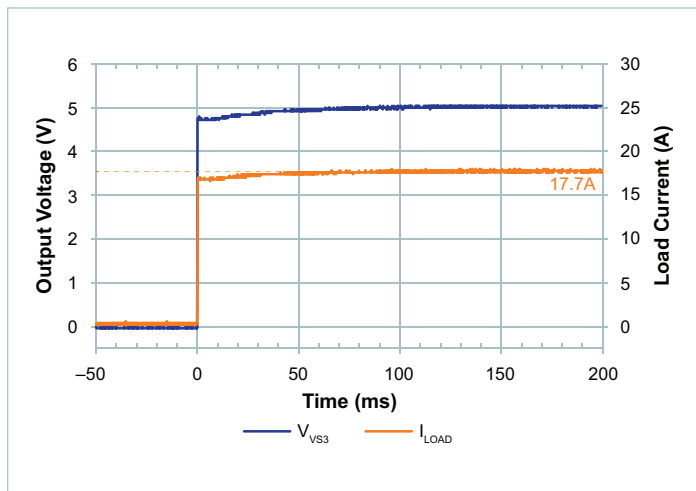

Figure 21 — Rise time of the VS3 (+5V) output with nominal load

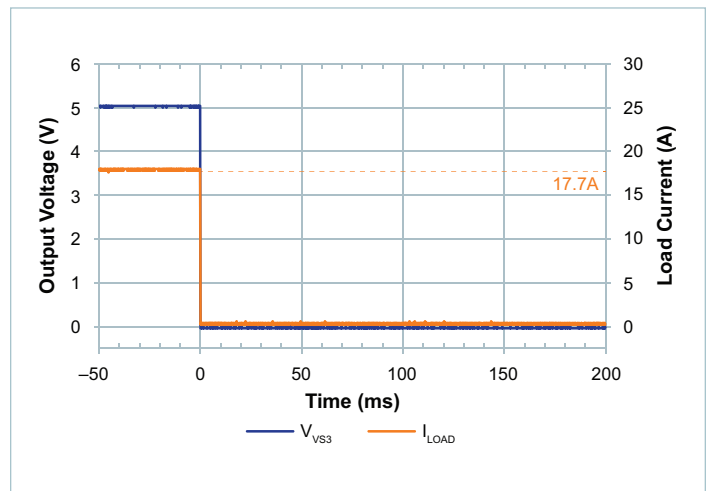

Figure 22 — Discharge time of the VS3 (+5V) output with nominal load

Application Characteristics (Cont.)

Load step response for all outputs being unloaded from 100% of their rated output to to no load simultaneously.

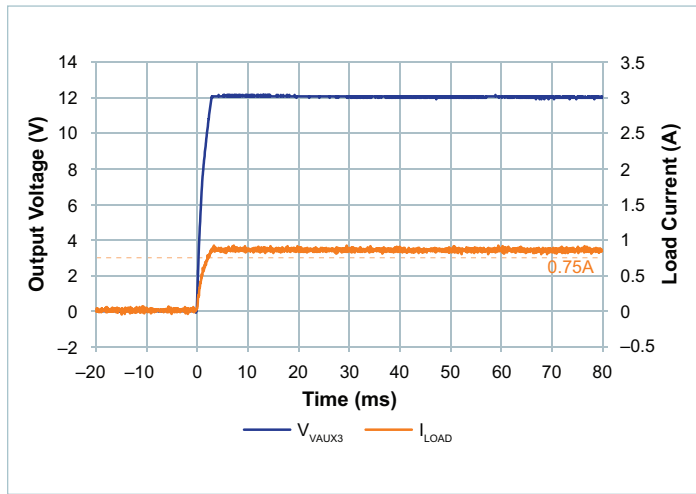

Figure 23 — Rise time of the VAUX3 (-12V) output with nominal load

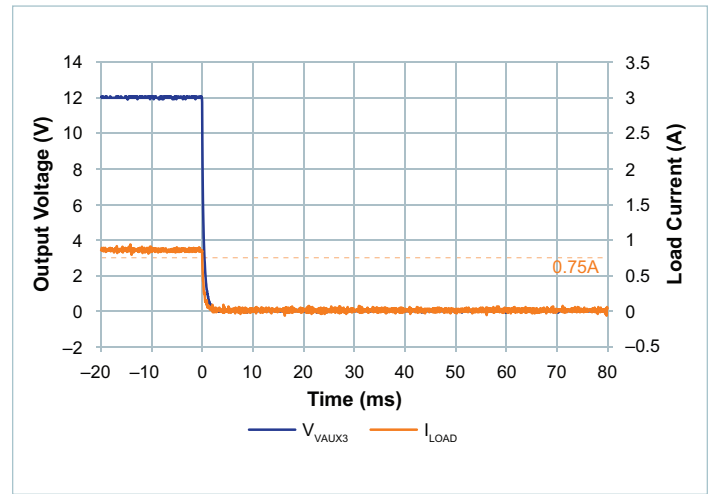

Figure 24 — Discharge time of the VAUX3 (-12V) output with nominal load

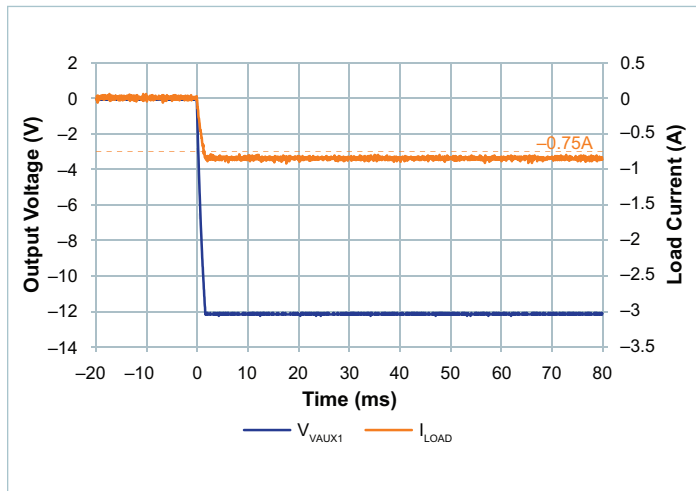

Figure 25 — Rise time of the VAUX1 (+12V) output with nominal load

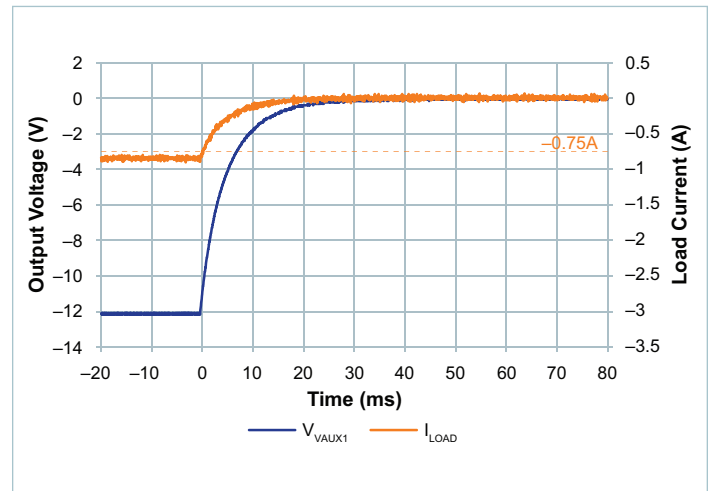

Figure 26 — Discharge time of the VAUX1 (+12V) output with nominal load

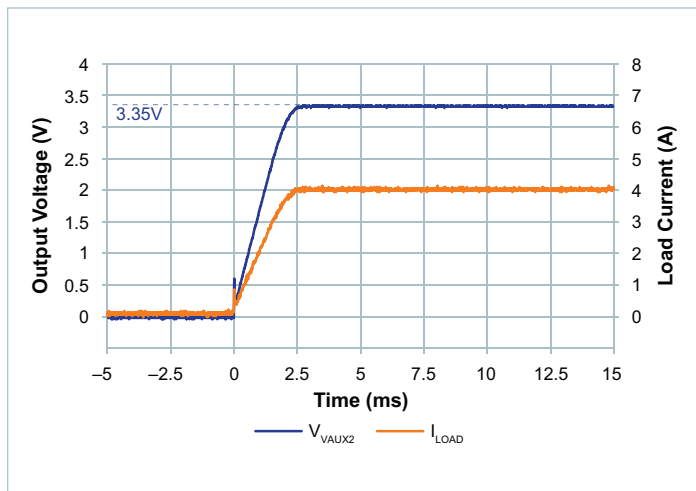

Figure 27 — Rise time of the VAUX2 (+3.3V) output with nominal load

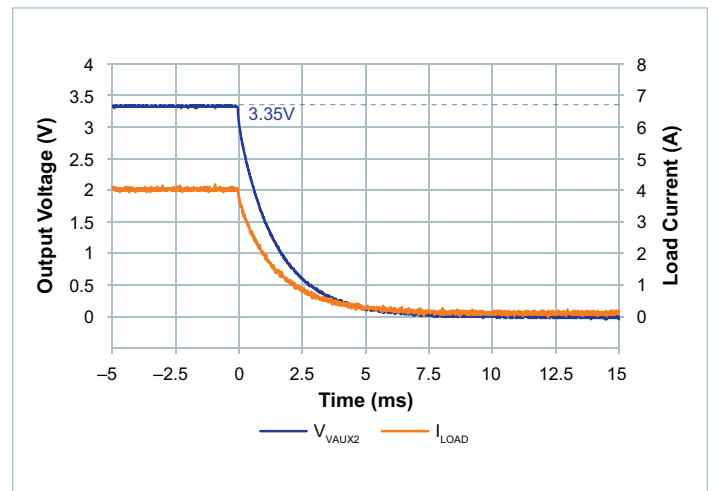

Figure 28 — Discharge time of the VAUX2 (+3.3V) output with nominal load

General Characteristics

Attribute	Symbol	Conditions / Notes	Min	Typ	Max	Unit
Mechanical						
Length	L	Per VITA62		6.634		in
Width	W	Per VITA62		3.937		in
Height	H	Per VITA62		0.951		in
Weight	W			635		g
Wedge-Lock Torque		Manufacturer's recommended value		7		in-lbs
Thermal						
Operating Temperature	T _{WEDGE-LOCKS}		-40		85	°C
Assembly						
Storage Temperature			-40		125	°C
Safety						
MTBF		MIL-HDBK-217Plus Parts Count - 25°C Ground Benign, Stationary, Indoors / Computer		TBD		Hrs
		Telcordia Issue 2 - Method I Case III; 25°C Ground Benign, Controlled		TBD		Hrs

Signal Pin Functions

ENABLE* & INHIBIT*

Enable and Inhibit pins express active low logic. Table 1 has the truth table for the output state of the power supply. It is necessary to avoid the indeterminate output state where 0.8 – 2.0V is applied to the ENABLE* or INHIBIT* pins.

A digital debounce filter is present on the signals of both pins to prevent false transitions. The ENABLE* and INHIBIT* also have a minimum delay between successive output enable transitions to prevent repeated starts into high capacitance loads. See detailed specifications for delays time limits.

ENABLE* Pin	INHIBIT* Pin	Output State and Notes
< 0.8V, Logic 0	> 2.0V or NO, Logic 1	All outputs available
< 0.8V, Logic 0	< 0.8V, Logic 0	Only +3.3V _{AUX} output available
> 2.0V or NO, Logic 1	Any	All outputs disabled
0.8V > V _{ENABLE*} < 2.0V	0.8V > V _{INHIBIT*} < 2.0V	Indeterminate state and must be avoided

Table 1 — ENABLE & INHIBIT logic

Global Address: GA0* & GA1*

Global address pins also exhibit active low logic. Table 2 has the truth table for the output state of the power supply. It is necessary to avoid the indeterminate state where 0.8 – 2.0V is applied to either address pins. A digital debounce filter is present on the signals of both pins to incorrect address assignment.

The global address is static and set on power up. The power supply’s address cannot not change until power has been cycled and the states of the address pins have been modified before power up.

Typical External Circuits for Signal Pins

(ENABLE*, INHIBIT*, GA0*, GA1*, SYSRESET*, FAIL* and I²C Channels)

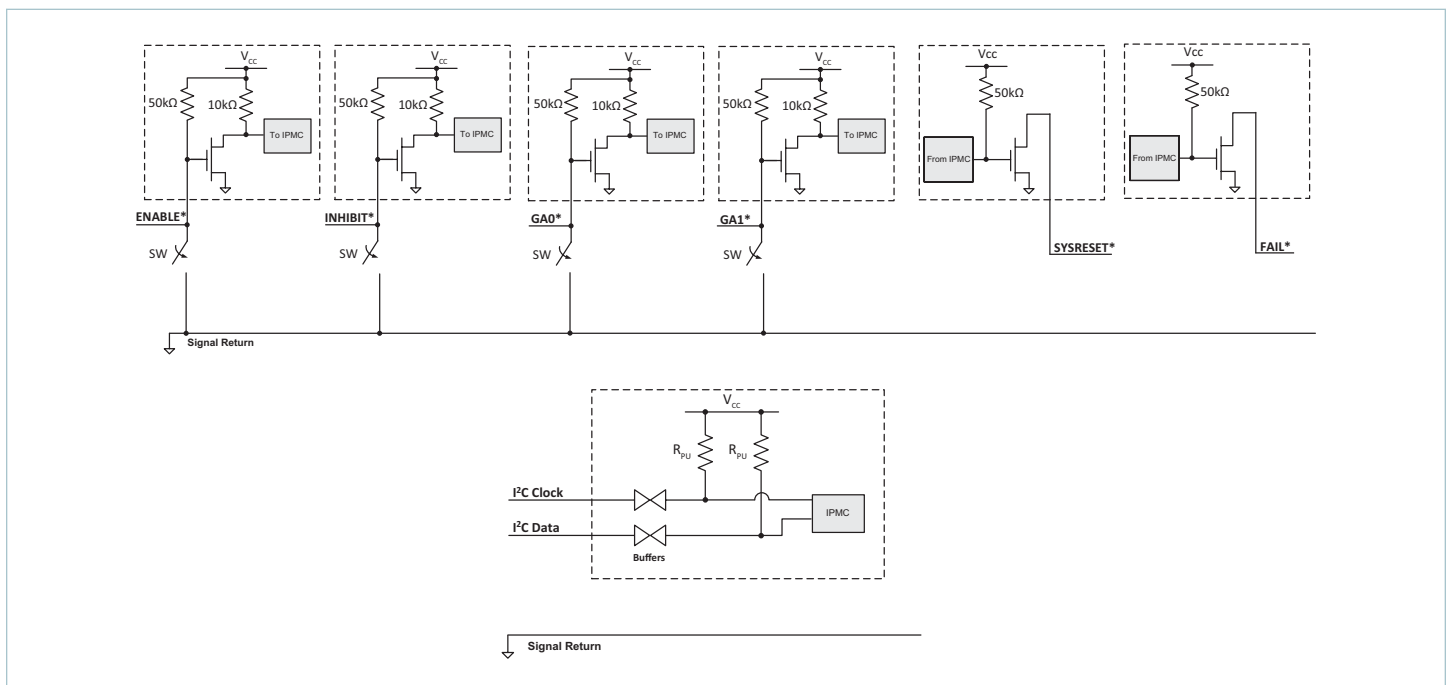

GA1*	GA0*	Power Supply Address
> 2.0V or NO, Logic 1	> 2.0V or NO, Logic 1	20h
> 2.0V or NO, Logic 1	< 0.8V, Logic 0	21h
< 0.8V, Logic 0	> 2.0V or NO, Logic 1	22h
< 0.8V, Logic 0	< 0.8V, Logic 0	23h
0.8V > V _{GA1*} < 2.0V	0.8V > V _{GA0*} < 2.0V	Indeterminate state and must be avoided

Table 2 — Global address assignment

I²C Ports:

Both primary and redundant I²C™ ports have the same address set by the Global Address pins and identical functionality. There is a bidirectional buffer on both clock and data lines with internal pull ups on the IPMC and external pulls on the back plane to +3.3V are required.

FAIL*

This signal line is open drain and tracks SYSRESET* when the unit is powering up or pulled down to SIGNAL_RETURN when any of the outputs are out of specification. A pull up resistor is expected on the backplane per section 4.6.3.7 of VITA 62.

SYSRESET*

This signal line is open drain and is pulled down to SIGNAL_RETURN when the unit is powering up. The line is released when the power supply is ready for control. Appropriate pull-up/pull-down resistors are expected on the back plane per VITA 46 section 7.3.9.

SIGNAL RETURN

SIGNAL RETURN is used as the reference for signals pin connections and is to be tied to POWER_RETURN on the backplane per section 4.6.3.10-1 of VITA 62.

Card Edge Temperature Sensors

The PCBA card edge temperature sensor internal to the power supply is mounted on the edge of the PCBA card edge. Consequently, the temperature sensor measures a temperature that is generally higher than the heat-sink-to-rail mounting interface and lower than the hot spot of the internal converters in the power supply.

Response from the power supply to I²C™ command 0x21 provides the temperature measured by the internal sensor that reads the higher temperature. This temperature can exceed 85°C. I²C command 0x92 will respond with both PCB mounted temperature sensors.

Fault Operation

Input Voltage Protection (IOVP)

If the input voltage to the power supply drops below V_{UV-IN} or exceeds V_{OV-IN} for at least 1ms, the power supply will shut down all outputs and digital communication lines until input voltage is within operating range V_{IN} . Triggering I_{OVP} has the same effect as power cycling the power supply. Supply currents and voltages are sampled every 200µs.

Output Voltage Protection (OOVP)

The power supply measures voltage from the remote-sense lines as well as the voltages on the VITA connector which do not include remote sense drop.

The FAIL* line will be asserted (pulled low) when output voltage at the connector of the power supply is greater than $V_{OV-S-[OUTPUT]}$ or lower than $V_{UV-S-[OUTPUT]}$. OVP will also shut down the outputs until the output voltage of the converter is within specification. The power supply will automatically restart the outputs every 1s until the fault clears.

Overcurrent Protection (OCP)*

There are two overcurrent protection limits for each output. The fast-response limit, $I_{OC-F-[OUTPUT]}$, responds to an overcurrent fault in less than 1ms after soft-start time, $t_{SS-[OUTPUT]}$, has elapsed since the output was enabled. Triggering OCP will cause all outputs to shut down for 1s and then automatically restart until the fault clears.

The slow-response current limit, $I_{OC-S-[OUTPUT]}$, responds to an overcurrent fault if the current exceeds the current limit after a 2Hz low-pass filter has filtered the measured current. The outputs will restart every 1s until the fault clears.

Overtemperature Protection (OTP)

The power supply will go into overtemperature protection and shut down all outputs when either internal temperature sensor reads 98°C. The power converter will recover for normal operation when the internal temperature has dropped by 20°C.

At 88°C the Bit-5 of the Status Register (0x55) will clear if the system manager sets Bit-5 to 1 which will indicate the power supply is within 10°C from shutting down.

At 85°C rail temperature, the maximum output power of the power supply is limited to 450W aggregate. When operating close to the thermal limits of the power supply, care must be taken to follow the thermal specified operating areas for aggregate and worst case loading shown in Figures 1 and 2, respectively.

When operating solely with output VS1 loaded to its rated output or outputs VS1, VAUX1, VAUX2, and VAUX3 loaded to their rated outputs combined, the maximum rail temperature should be held to 75°C or lower. Auxiliary voltages are powered from the converter providing output VS1.

Conducted Emissions Testing

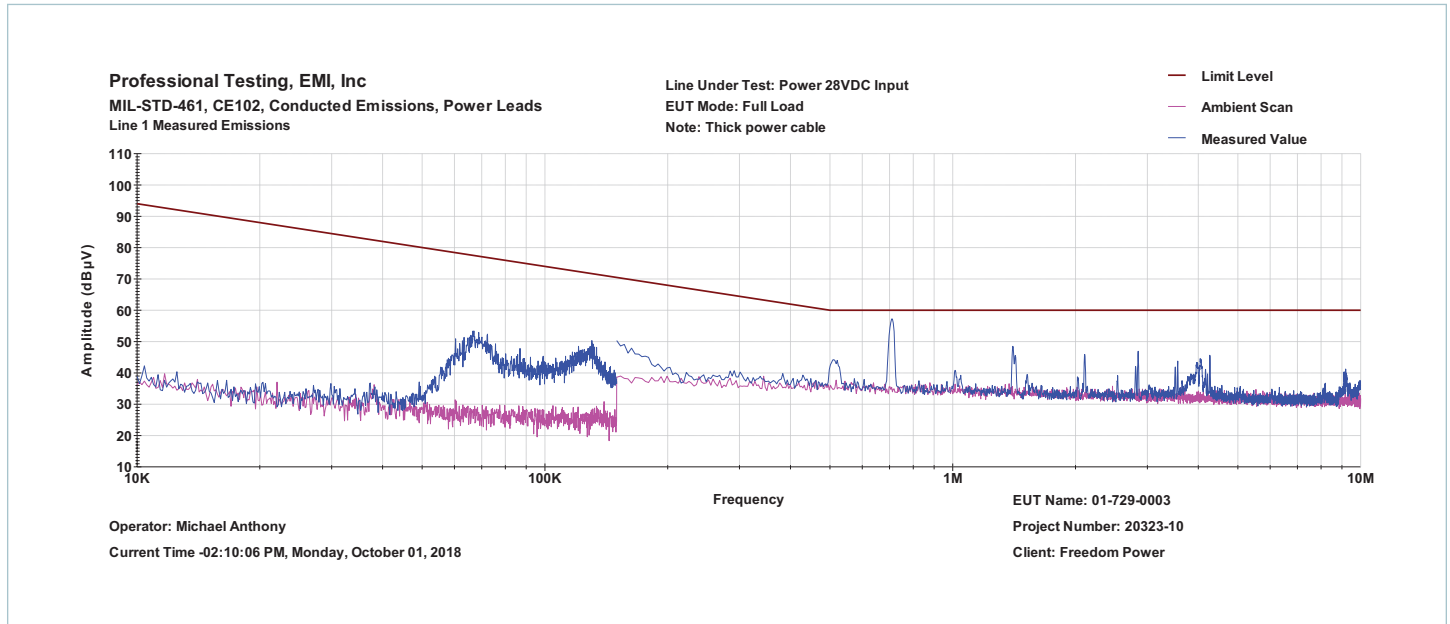

Figure 29 — Conducted emissions of 28V_{DC} input at full load

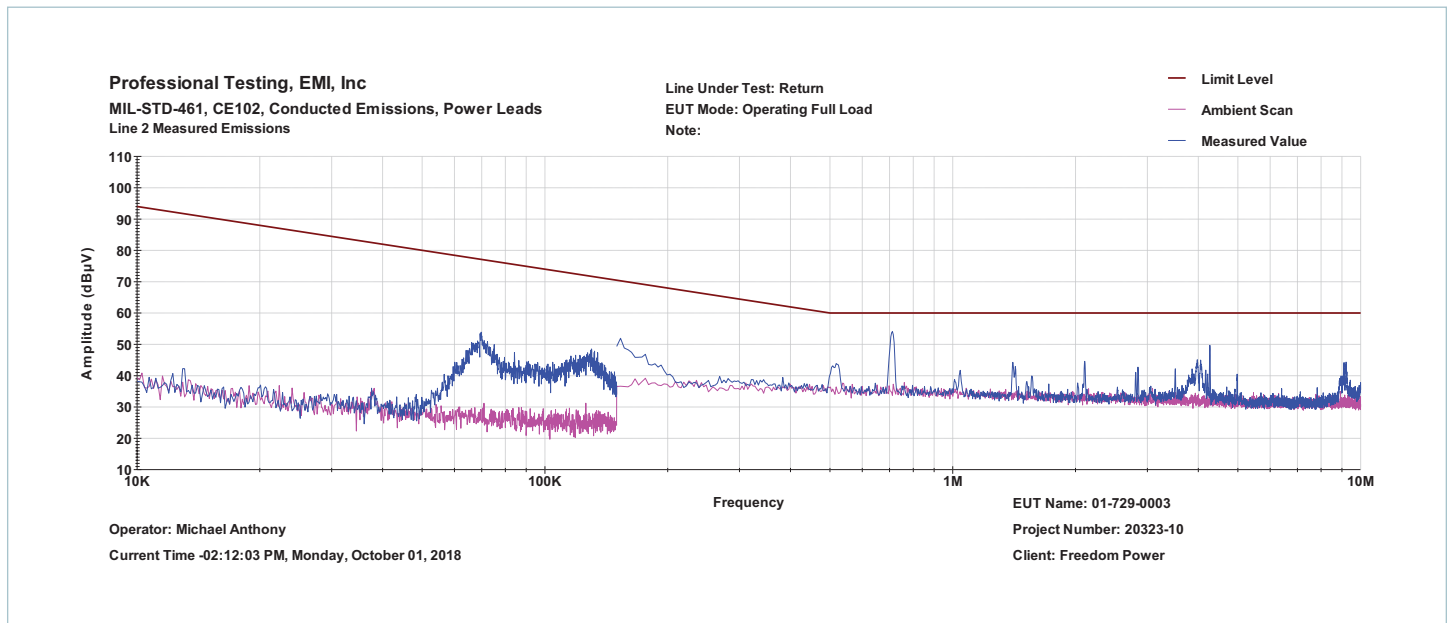

Figure 30 — Conducted emissions of power return at full load

Standards Compliance

MIL-STD-461C		
CS06	±200V, 10µs	Pass
	±400V, 5µs	Pass
	1000 – 2000Hz PSD decreasing at 6dB/octave	Pass
MIL-STD-461F		
CE101	Figure CE101-4, Curve #2	Pass
CS101	Figure CS101-1, Curve #2	Pass
CS114 Curve 5 ^[d]	Input power lead	Pass
	Bulk input power cables	Pass
	+12V and output RTN	Pass
	+3.3V and output RTN	Pass
	+5V and output RTN	Pass
	Auxiliary –12V and output RTN	Pass
	Auxiliary +3.3V and output RTN	Pass
CS115	Bulk input power cables	Pass
	Bulk output power cables	Pass
CS116	Bulk input power cables	Pass
	Bulk output power cables	Pass
MIL-STD-704F		
LDC103 – Voltage Distortion Spectrum		Pass
LDC105 – Normal Voltage Transients		Pass
LDC302 – Abnormal Voltage Transients		Pass
MIL-STD-801G		
Vibration, Method 514.5 Procedure I	1 – 100Hz PSD increasing at 3dB/octave	Pass
	100 – 1000Hz PSD = 0.1g ² /Hz	Pass
	1000 – 2000Hz PSD decreasing at 6dB/octave	Pass
Operating Shock, Method 516 Procedure I	40g, 11ms shock half-sine	Pass
	40g, 11ms, terminal saw-tooth shock pulses in all three axes	Pass
MIL-STD-1275D		
Normal Operating Surges	Paragraph 5.1.3.3 Surges, Figure 5	Pass
Exported Voltage Spikes	Paragraph 5.1.3.4, Figure 6; Procedure 5.3.2.2	Pass
Imported Voltage Spikes	Paragraph 5.1.3.4, Figure 6; Procedure 5.3.2.3	Pass
RTCA/DO-160G		
Section 17: Voltage Spike, Category A		Pass
Section 17: ESD		Pass
IEC 61000-4-2		
ESD, Level 4	±15kV Air Discharge	Pass

^[d] Pass criteria is no loss of any output voltages during the test for any period of time.

I²C™ Sensor Commands

Commands are sent by SMBus-compatible packets over the I²C physical interface. The I²C bus will communicate at 100kHz. Pull-up resistors to +3.3V are expected on the system backplane.

Two pins, labeled *GA1 and *GA0 are provided at each power supply slot, where *GA1 and *GA0 are defined to be active (SET) when low. The power supply will respond to I²C address 010 00[GA1][GA0]

Commands Recognized by Power Supply

0x21: Sensor Data (Read Only) ^[e]			
Byte Number	Contents	Format	Scaling
0	0x21	Byte	Echo of the command
1	Status Reg	Byte	See below, same as used by command 0x55
2, 3	PCBA Temperature °C	UINT16	16384 = 100°C
4, 5	+12V VSENSE	UINT16	16384 = 12.0V
6, 7	+3.3V VSENSE	UINT16	16384 = 3.3V
8, 9	+5V VSENSE	UINT16	16384 = 5.0V
10, 11	+3.3VAUX VSENSE	UINT16	16384 = 3.3V
12, 13	+12VAUX VSENSE	UINT16	16384 = 12.0V
14, 15	-12VAUX VSENSE	UINT16	16384 = -12.0V, absolute value
16, 17	+12V IOUT	UINT16	16384 = 30A
18, 19	+3.3V IOUT	UINT16	16384 = 20A
20, 21	+5V IOUT	UINT16	16384 = 40A
22, 23	+3.3VAUX IOUT	UINT16	16384 = 4A
24, 25	+12VAUX IOUT	UINT16	16384 = 1A
26, 27	-12VAUX IOUT	UINT16	16384 = -1A, absolute value
28, 29	INT REFERENCE	UINT16	16384 = 2.50V
30, 31	Input Voltage	UINT16	16384 = 28V
32 – 51	Part Number	CHAR[20]	no 0 term, padded with 0x20
52 – 55	Serial Number	UINT32	Unsigned 32-bit integer; last 9 digits of the serial number of the unit on the label
56, 57	Factory Use Only	UINT16	N/A: factory use only
58, 59	Hardware Rev	CHAR[2]	See label information
60, 61	Firmware Rev	CHAR[2]	
62	Input Current	UINT8	255 = 40A
63	Zero Checksum	Byte	Sum(byte 0:63) = 0

^[e] Most-significant bit of each byte is transmitted first.
Most-significant byte of UINT16 and UINT32 transmitted first.

The general format is as follows:

- **Command from controller I²C / SMBus master:**
 - Address+R/*W
 - Command Byte
 - Number of Bytes
 - Zero Checksum
- **Response from power supply I²C / SMBus slave:**
 - Command Echo
 - Data Bytes
 - Zero Checksum

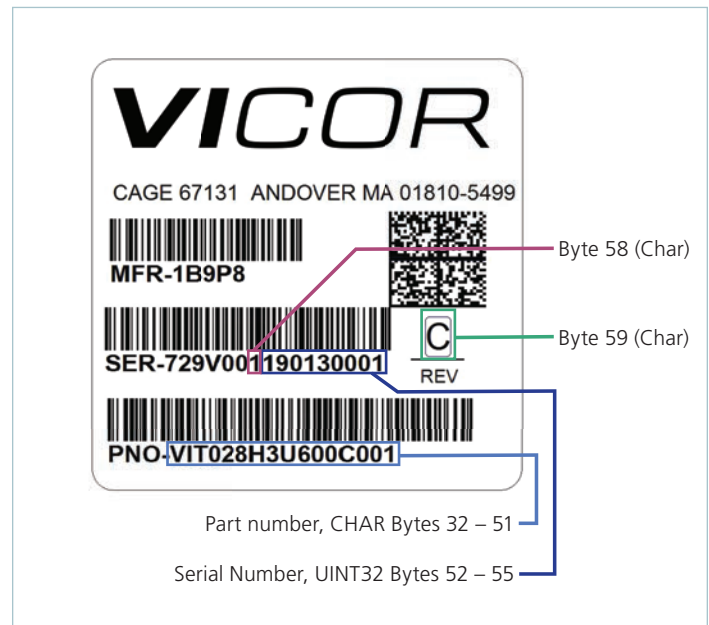

Figure 31 — Product label information

Commands Recognized by Power Supply (Cont.)

0x44: Firmware Date (Read Only) ^[f]			
• 22 byte response in ASCII form.			
Byte Number	Contents	Format	Typical Value
0	0x44	Byte	Echo of the command
1 – 20	Date	ASCII[20]	'NOV 28 14:32:54 2018'
21	Zero Checksum	Byte	
0x45: Hardware Address (Read Only) ^[f]			
• Uses SMBus Read Byte protocol, section 6.5.5, with or without 0 PEC			
Byte Number	Contents	Format	Typical Value
0	0x45	Byte	
1	I ² C Address	Byte	0x23, set by *GA1, *GA0
2	Zero Checksum	Byte	Sum(byte 0:2) = 0
0x55: Status Command (Read/Write) ^[f]			
• Uses SMBus Write Byte/Read Byte protocol, section 6.5.4, 6.5.5, with or without 0 PEC			
Byte Number	Contents	Format	Typical Value
0	0x55	Byte	
1	Status Byte	Byte	0x18 = All outputs ON
2	Zero Checksum	Byte	Sum(byte 0:2) = 0
0x90: All Voltages in mV (Read) ^[f]			
Byte Number	Contents	Format	Scaling
0	0x21	Byte	Echo of the command
1, 2	+12V SENSE	UINT16	1mV/bit
3, 4	+3.3V SENSE	UINT16	1mV/bit
5, 6	+5V SENSE	UINT16	1mV/bit
7, 8	+3.3VAUX SENSE	UINT16	1mV/bit
9, 10	+12VAUX VSENSE	UINT16	1mV/bit
11, 12	-12VAUX VSENSE	UINT16	-1mV/bit
13, 14	Input Voltage	UINT16	1mV/bit
15	Zero Checksum	Byte	Sum(byte 0:14) = 0

^[f] Most-significant bit of each byte is transmitted first.
Most-significant byte of UINT16 and UINT32 transmitted first.

0x99: Main Outputs – Output and Input Current in mA (Read) ^[f]			
Byte Number	Contents	Format	Scaling
0	0x99	Byte	Echo of the command
1, 2	+12V IOUT	UINT16	1mA/bit
3, 4	+3.3V IOUT	UINT16	1mA/bit
5, 6	+5V IOUT	UINT16	1mA/bit
7, 8	Input Current	UINT16	1mA/bit
9	Zero Checksum	Byte	Sum(byte 0:8) = 0
0x91: Auxiliary Outputs – Output Current in mA (Read) ^[f]			
Byte Number	Contents	Format	Scaling
0	0x91	Byte	Echo of the command
1, 2	+3.3VAUX IOUT	UINT16	1mA/bit
3, 4	+12VAUX IOUT	UINT16	1mA/bit
5, 6	-12VAUX IOUT	UINT16	-1mA/bit
7	Zero Checksum	Byte	Sum(byte 0:6) = 0
0x92: PCBA Card Edge Temperatures in °C x 10 (Read) ^[f]			
Byte Number	Contents	Format	Scaling
0	0x92	Byte	Echo of the command
1, 2	3U P0 connector, P1 side Rail	INT16	Temperature x 10, eg. -123 = -12.3°C
3, 4	3U P0 connector, P6 side Rail	INT16	Same as above
5	Zero Checksum	Byte	Sum(byte 0:4) = 0

Status Register Bit Map (Byte 1) used in command 0x55

Bit 0 and 1 allow you to monitor what the power supply is reading from the input connector.

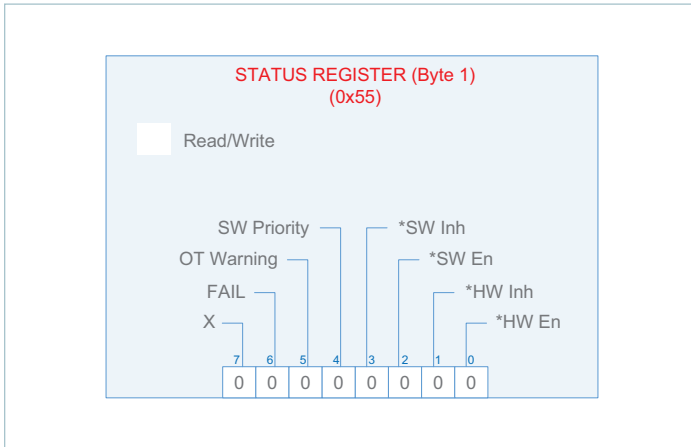

Bit	Name	Condition	Default
7	X	0	0
6	FAIL	If set to 1 by System Manager, a fault condition will clear this bit.	0
5	OT Warning	If set to 1 by System Manager, an OT fault will clear this bit.	0
4	SW Priority	Set to 1 for SW Control	0
3	*SW Inh	EN all, 0 EN only 3.3V	0
2	*SW En	ALL outputs regardless	0
1	*HW Inh	As read by HW	BACKPLANE
0	*HW En	As read by HW	BACKPLANE

Power Architecture

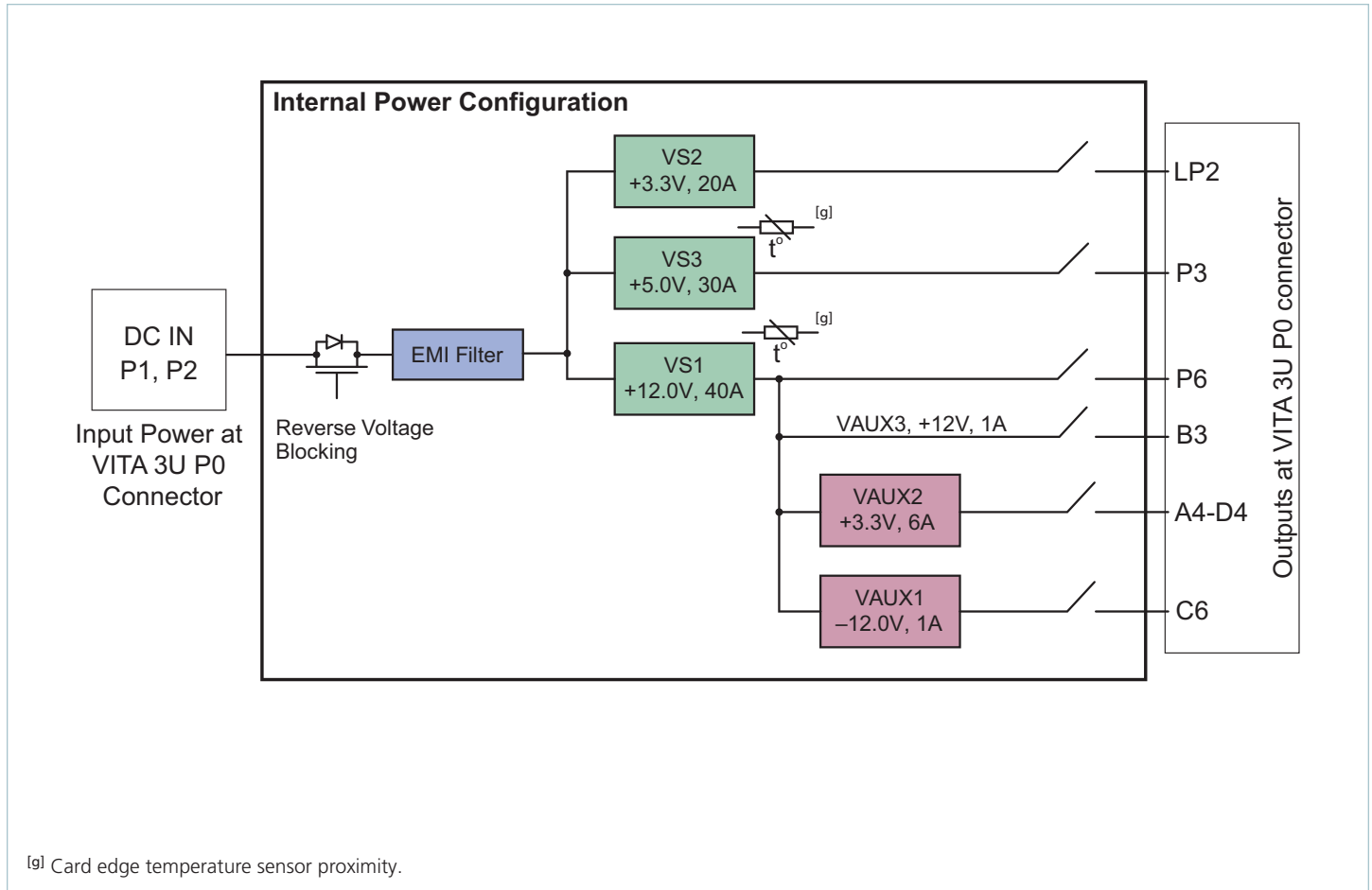

Mechanical Drawing

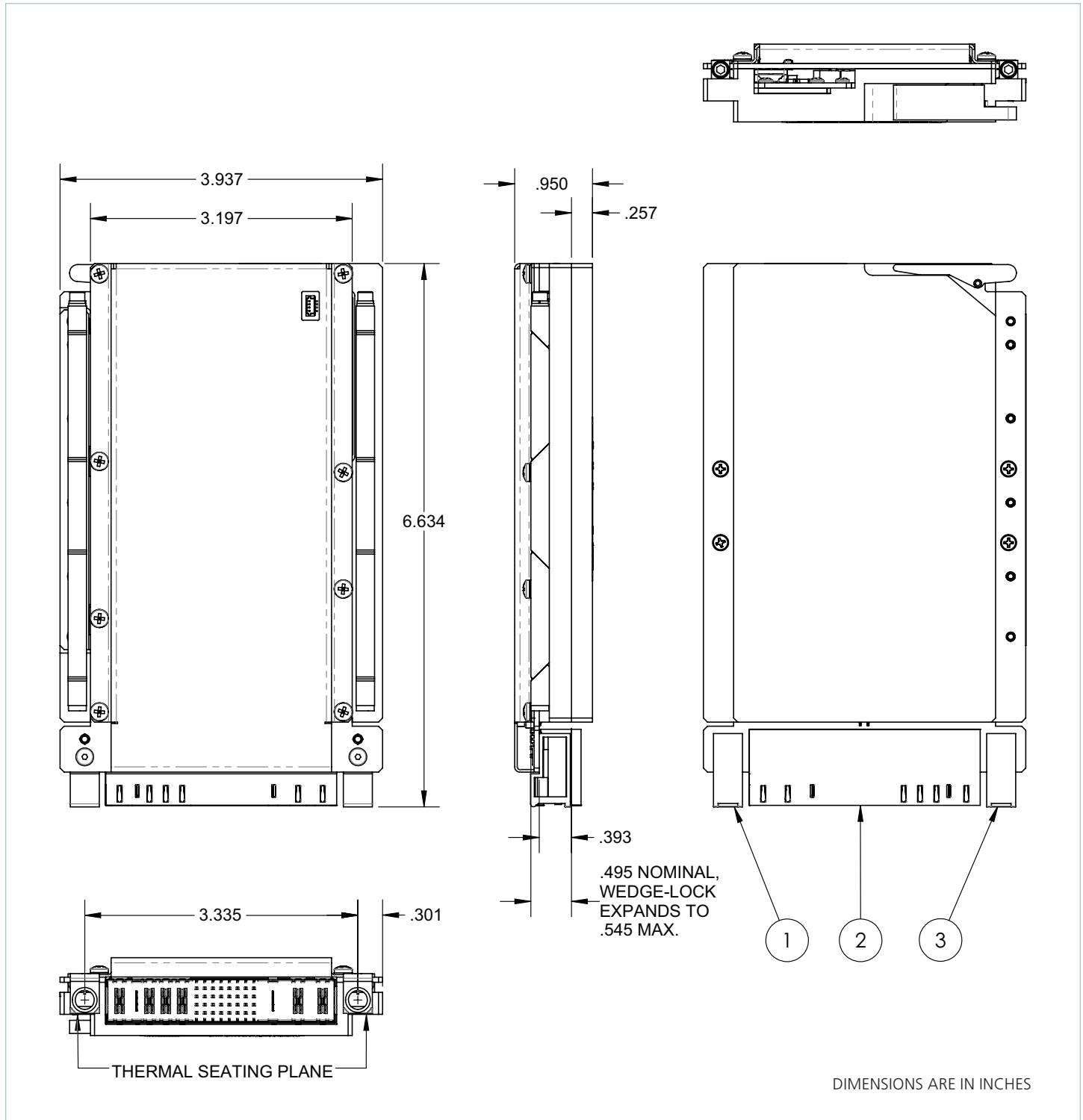

Connector Components

Item #	Description	Manufacturer	Manufacturer Part Number
1	VITA46 0 DEG Guide Socket	TE Connectivity	1-1469492-1
2	VITA62 Connector Plug	TE Connectivity	6450849-7
3	VITA46 0 DEG Guide Socket	TE Connectivity	1-1469492-1

Revision History

Revision	Date	Description	Page Number(s)
1.0	02/07/19	Initial release	n/a
1.1	06/19/19	Changed NC to NO in Tables 1 and 2	17
1.2	04/14/20	Standard compliance MIL-STD-704F updated to pass status Part number option -001 removed (end of life) Product label information updated	1, 20 4 21

Contact Us: <http://www.vicorpower.com/contact-us>

Vicor Corporation
25 Frontage Road
Andover, MA, USA 01810
Tel: 800-735-6200
Fax: 978-475-6715
www.vicorpower.com

email
Customer Service: custserv@vicorpower.com
Technical Support: apps@vicorpower.com

©2019 – 2020 Vicor Corporation. All rights reserved. The Vicor name is a registered trademark of Vicor Corporation.
i²C™ is a trademark of NXP semiconductor.
All other trademarks, product names, logos and brands are property of their respective owners.

Mouser Electronics

Authorized Distributor

Click to View Pricing, Inventory, Delivery & Lifecycle Information:

[Vicor:](#)

[VIT028H3U600C001](#) [VIT028H3U600C002](#) [VIT028H3U600D001](#) [VIT028H3U600D002](#) [VIT028H3U600C000](#)
[VIT028H3U600D000](#) [VIT028H6U1000C000](#)



Компания «ЭлектроПласт» предлагает заключение долгосрочных отношений при поставках импортных электронных компонентов на взаимовыгодных условиях!

Наши преимущества:

- Оперативные поставки широкого спектра электронных компонентов отечественного и импортного производства напрямую от производителей и с крупнейших мировых складов;
- Поставка более 17-ти миллионов наименований электронных компонентов;
- Поставка сложных, дефицитных, либо снятых с производства позиций;
- Оперативные сроки поставки под заказ (от 5 рабочих дней);
- Экспресс доставка в любую точку России;
- Техническая поддержка проекта, помощь в подборе аналогов, поставка прототипов;
- Система менеджмента качества сертифицирована по Международному стандарту ISO 9001;
- Лицензия ФСБ на осуществление работ с использованием сведений, составляющих государственную тайну;
- Поставка специализированных компонентов (Xilinx, Altera, Analog Devices, Intersil, Interpoint, Microsemi, Aeroflex, Peregrine, Syfer, Eurofarad, Texas Instrument, Miteq, Cobham, E2V, MA-COM, Hittite, Mini-Circuits, General Dynamics и др.);

Помимо этого, одним из направлений компании «ЭлектроПласт» является направление «Источники питания». Мы предлагаем Вам помощь Конструкторского отдела:

- Подбор оптимального решения, техническое обоснование при выборе компонента;
- Подбор аналогов;
- Консультации по применению компонента;
- Поставка образцов и прототипов;
- Техническая поддержка проекта;
- Защита от снятия компонента с производства.



Как с нами связаться

Телефон: 8 (812) 309 58 32 (многоканальный)

Факс: 8 (812) 320-02-42

Электронная почта: org@eplast1.ru

Адрес: 198099, г. Санкт-Петербург, ул. Калинина, дом 2, корпус 4, литера А.