



ETA-USA

HIGH QUALITY SWITCHING POWER SUPPLIES

AC/DC SWITCHING POWER SUPPLY
SINGLE CHANNEL OUTPUT
500 WATTS
UNIVERSAL INPUT

ZMP500-SX-F-W-D SERIES

General Description



Features

1. Current sharing ("-D"), up to 4 units can be paralleled within 10% accuracy at full load
2. Short circuit protection
3. Over load protection
4. Over voltage protection
5. Remote inhibit function

Options

Comes with either top fan (denoted by suffix "-T") or end fan (denoted by "-S")

Application

Broad needs

Input

Input Voltage Range: AC90~264V

Frequency: 50/60 Hz

Frequency Range: 47~63 Hz

Phase: Single

Inrush Current:*1, *4 <17.5A peak@115VAC;
<35A peak@230VAC cold start at 25 degrees C

Input Current: 6A max at 115VAC





ETA-USA

HIGH QUALITY SWITCHING POWER SUPPLIES

Output Characteristic	Unit	Models						
		ZMP500-12SX-F-W-D	ZMP500-24SX-F-W-D	ZMP500-30SX-F-W-D	ZMP500-36SX-F-W-D	ZMP500-48SX-F-W-D	ZMP500-54SX-F-W-D	ZMP500-57SX-F-W-D
Output Voltage	Vdc	12	24	30	36	48	54	57
Output Current	A	30	15	12	10	7.5	6.67	6.32
Max Output Current	A	41.67	20.84	16.67	13.89	10.42	9.26	8.78
Ripple & Noise(max)	mVpp	120	240	300	360	480	540	570
Hold up time	mS	20 mS at 360W load, 115VAC input						
Regulation								
O/P Regulation [max]	mV	±5% at 25°C with input and output adjusted to factory settings						

Efficiency *1	%	At AC100V 83% At AC 200V 86%
Power Factor *1		>0.9 @ 115VAC / 230VAC

Environmental Specification	
Operating Temperature*3	0 to +50 °C Derating 2.5% / °C from 50°C to 70°C
Temperature coefficient	±0.04% / °C
Operating Humidity	5~95% RH non condensing
Isolation Voltage	Input-Output 5656 VDC Input-Ground 2121 VDC Output Ground 707 VDC
Cooling	Forced air cooling
Leakage current	<300µA @ 264VAC
MTBF	>100,000 hours
Environmental Agencies	
Safety	UL60601-1, CSA-C22.2 No. 601.1M9 , TUV EN60601-1, CB IEC60601-1
EMI Safety	EN60601-2, FCC Part 18 Class B, EN55011 Class B, CE
Function/Protection	
Over current Protection	110% to 150% max rating. Auto recovery
Over voltage Protection	110 to 130% of output. Latching type AC recycle
Remote Sense	Not Available
Remote Control	Not Available
Series Operation	Available
Parallel Operation	Available, up to 4
Standby	5V/1A standby output, 12V/1A for fan
Mechanical	
Dimension [mm]	203.2L x 118.5W x 38.5H





ETA-USA

HIGH QUALITY SWITCHING POWER SUPPLIES

Conditions:

- *1 Rated input and Rated output
- *2 at Output current quick change 25% to 75%
- *3 At 100% load (convection cooling)
- *4 Cold start at 25 °C Ambient temp.





ETA-USA

HIGH QUALITY SWITCHING POWER SUPPLIES

Mechanical Drawings

ZMP500-SX-F-W-D

Option : U, U-Channel

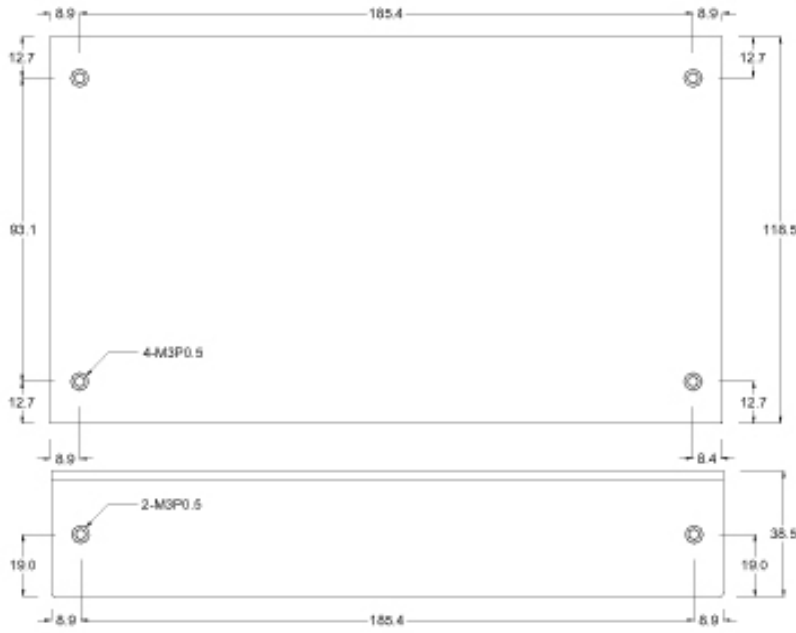
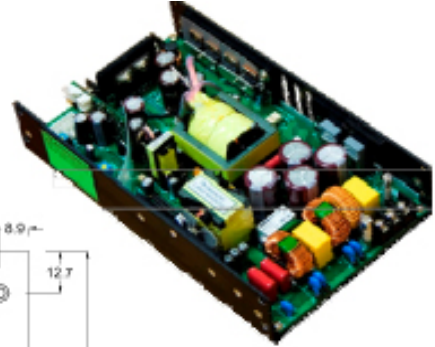

CN4

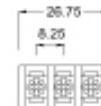

CN1

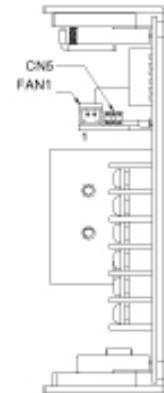
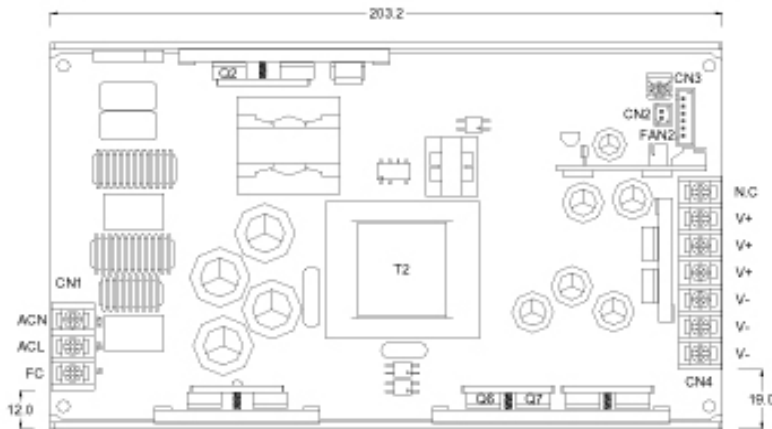

CN3 P2 5-6P (OPTION) Molex P/N 48152-0610 OR Equivalent	PIN1	Current Sense
	PIN2	Inhibit
	PIN3	GND
	PIN4	5Vsb
	PIN5	-Sensor
	PIN6	+Sensor

CN2 P2 5-2P Molex P/N 48152-0210 OR Equivalent	PIN1	5Vsb
	PIN2	GND
FAN1 P2 5-2P Molex P/N 48153-0210 OR Equivalent	PIN1	12V FAN +
	PIN2	12V FAN -
FAN2 P2 5-2P (With speed control) Molex P/N 48152-0210 OR Equivalent	PIN1	FAN +
	PIN2	FAN -

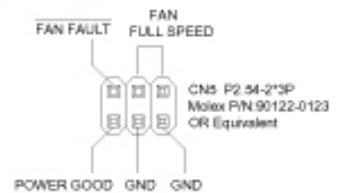



ETA-USA

HIGH QUALITY SWITCHING POWER SUPPLIES

Top fan (“-T”)

Option : T, Fan on top

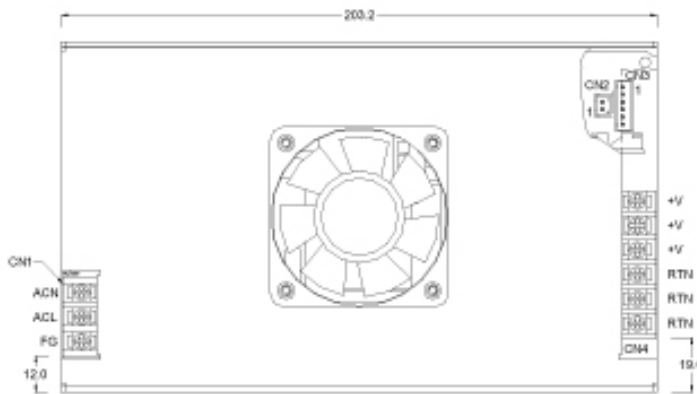
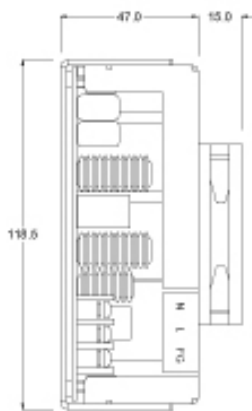
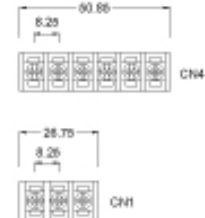
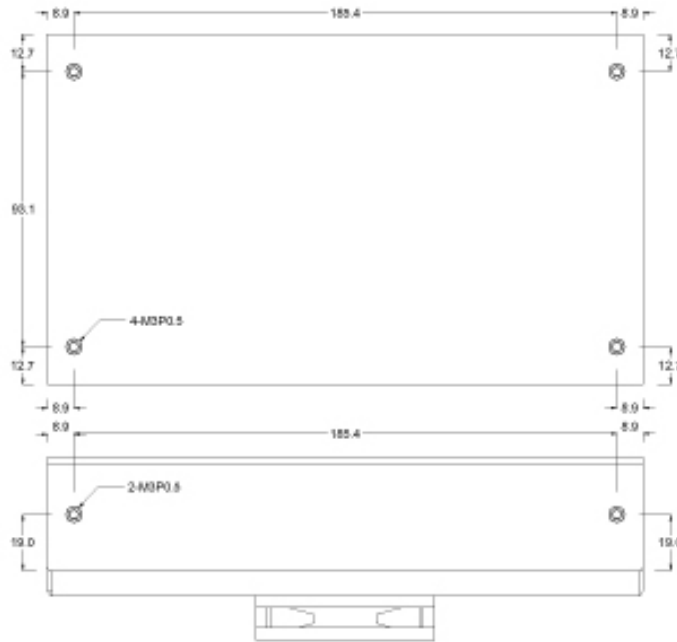
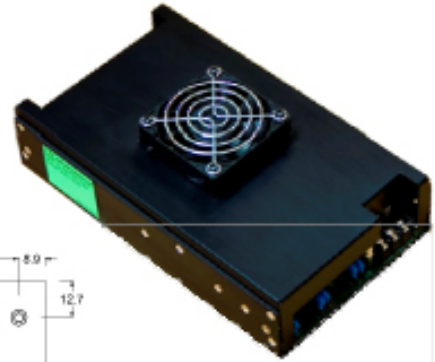

CN3 P2.5-6P (OPTION) Molex P/N 48152-0210 OR Equivalent	PIN1	Current Sense
	PIN2	Inhibit
	PIN3	GND
	PIN4	5Vsb
	PIN5	-Sensor
	PIN6	+Sensor

CN2 P2.5-2P Molex P/N 48152-0210 OR Equivalent	PIN1	5Vsb
	PIN2	GND
FAN1 P2.5-2P Molex P/N 48153-0210 OR Equivalent	PIN1	12V FAN +
	PIN2	12V FAN -

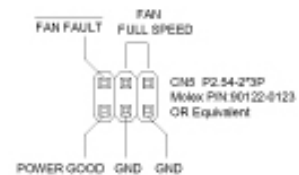



ETA-USA

HIGH QUALITY SWITCHING POWER SUPPLIES

End fan (“-S”)

Option : S, End Fan

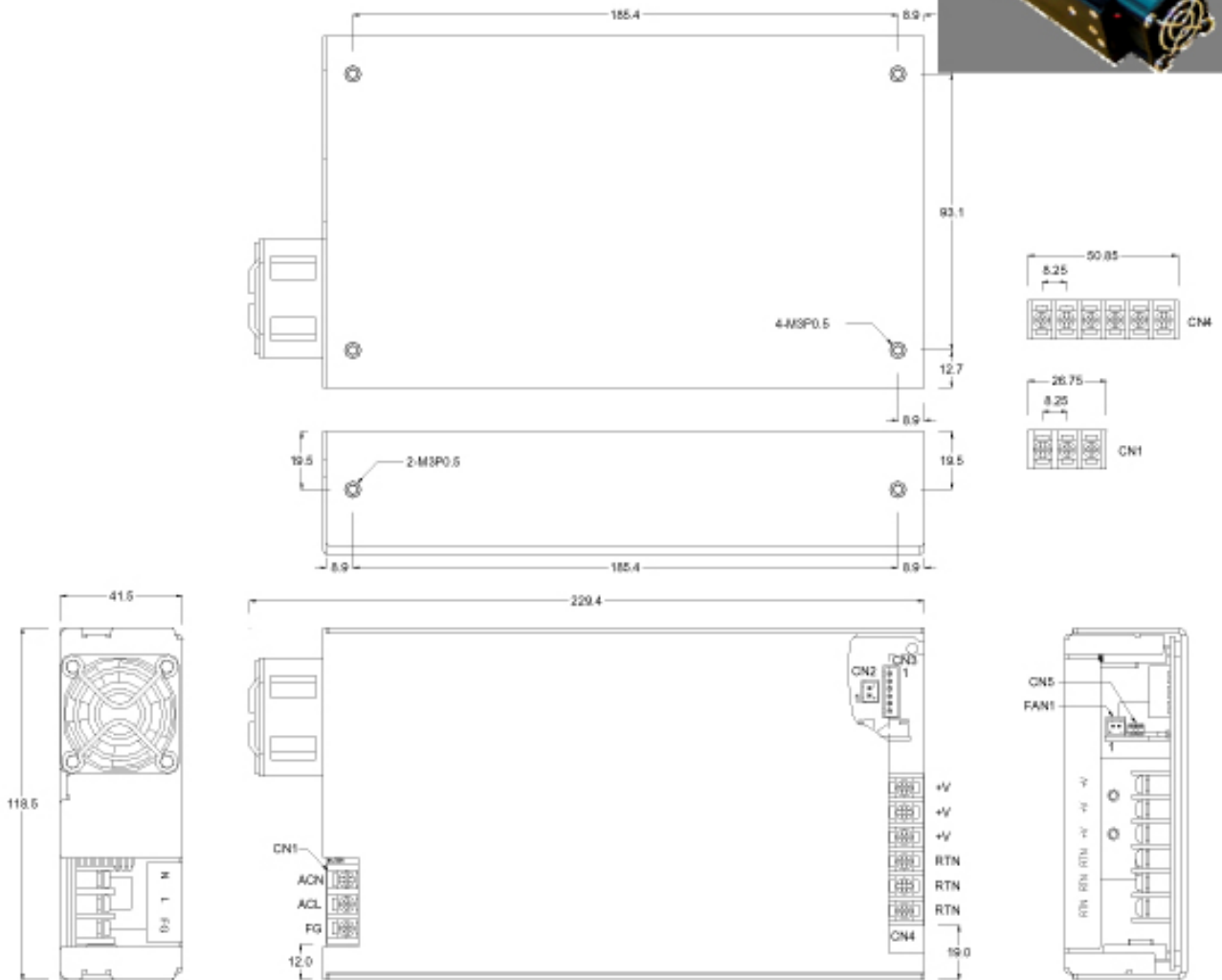
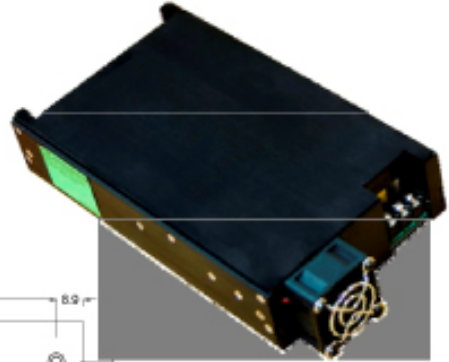

CN3 P2.5-6P (OPTION) Molex PIN-45152-0210 OR Equivalent	PIN1	Current Sense
	PIN2	Inhibit
	PIN3	GND
	PIN4	5Vsb
	PIN5	-Sensor
	PIN6	+Sensor

CN2 P2.5-2P Molex PIN-45152-0210 OR Equivalent	PIN1	5Vsb
	PIN2	GND
FAN1 P2.5-2P Molex PIN-45153-0210 OR Equivalent	PIN1	12V FAN +
	PIN2	12V FAN -

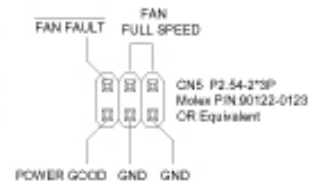



Компания «ЭлектроПласт» предлагает заключение долгосрочных отношений при поставках импортных электронных компонентов на взаимовыгодных условиях!

Наши преимущества:

- Оперативные поставки широкого спектра электронных компонентов отечественного и импортного производства напрямую от производителей и с крупнейших мировых складов;
- Поставка более 17-ти миллионов наименований электронных компонентов;
- Поставка сложных, дефицитных, либо снятых с производства позиций;
- Оперативные сроки поставки под заказ (от 5 рабочих дней);
- Экспресс доставка в любую точку России;
- Техническая поддержка проекта, помощь в подборе аналогов, поставка прототипов;
- Система менеджмента качества сертифицирована по Международному стандарту ISO 9001;
- Лицензия ФСБ на осуществление работ с использованием сведений, составляющих государственную тайну;
- Поставка специализированных компонентов (Xilinx, Altera, Analog Devices, Intersil, Interpoint, Microsemi, Aeroflex, Peregrine, Syfer, Eurofarad, Texas Instrument, Miteq, Cobham, E2V, MA-COM, Hittite, Mini-Circuits, General Dynamics и др.);

Помимо этого, одним из направлений компании «ЭлектроПласт» является направление «Источники питания». Мы предлагаем Вам помощь Конструкторского отдела:

- Подбор оптимального решения, техническое обоснование при выборе компонента;
- Подбор аналогов;
- Консультации по применению компонента;
- Поставка образцов и прототипов;
- Техническая поддержка проекта;
- Защита от снятия компонента с производства.



Как с нами связаться

Телефон: 8 (812) 309 58 32 (многоканальный)

Факс: 8 (812) 320-02-42

Электронная почта: org@eplast1.ru

Адрес: 198099, г. Санкт-Петербург, ул. Калинина, дом 2, корпус 4, литера А.