

## Trench gate field-stop IGBT, V series 600 V, 40 A very high speed

Datasheet - production data

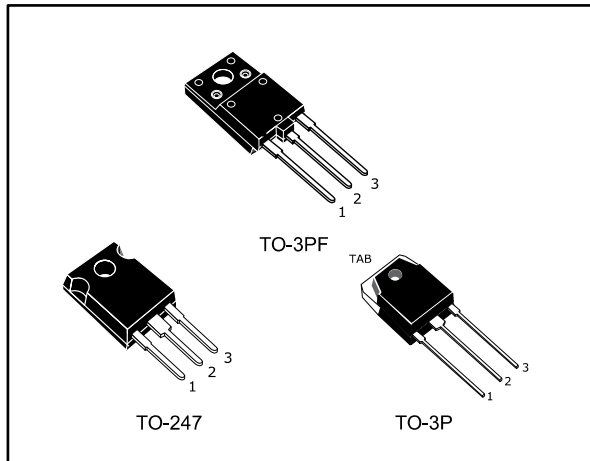
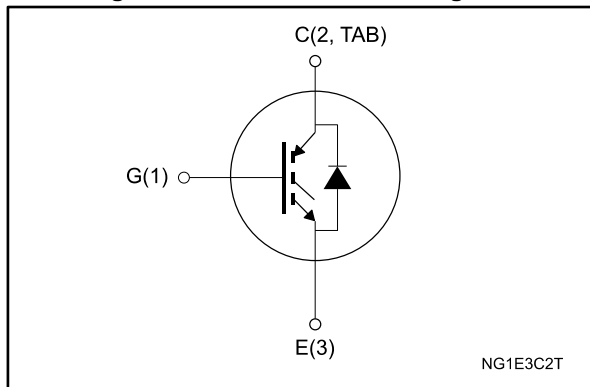


Figure 1: Internal schematic diagram



### Features

- Maximum junction temperature:  $T_J = 175\text{ }^\circ\text{C}$
- Tail-less switching off
- $V_{CE(sat)} = 1.8\text{ V (typ.) @ } I_c = 40\text{ A}$
- Tight parameters distribution
- Safe paralleling
- Low thermal resistance
- Very fast soft recovery antiparallel diode

### Applications

- Photovoltaic inverters
- Uninterruptible power supply
- Welding
- Power factor correction
- Very high frequency converters

### Description

This device is an IGBT developed using an advanced proprietary trench gate field-stop structure. The device is part of the V series IGBTs, which represent an optimum compromise between conduction and switching losses to maximize the efficiency of very high frequency converters. Furthermore, the positive  $V_{CE(sat)}$  temperature coefficient and very tight parameter distribution result in safer paralleling operation.

Table 1: Device summary

Order code	Marking	Package	Packing
STGFW40V60DF	GFW40V60DF	TO-3PF	Tube
STGW40V60DF	GW40V60DF	TO-247	Tube
STGWT40V60DF	GWT40V60DF	TO-3P	Tube

---

## Contents

<b>1</b>	<b>Electrical ratings .....</b>	<b>3</b>
<b>2</b>	<b>Electrical characteristics .....</b>	<b>4</b>
	2.1 Electrical characteristics curves .....	6
<b>3</b>	<b>Test circuits .....</b>	<b>13</b>
<b>4</b>	<b>Package information .....</b>	<b>14</b>
	4.1 TO-3PF package information .....	14
	4.2 TO-247 package information .....	16
	4.3 TO-3P package information .....	18
<b>5</b>	<b>Revision history .....</b>	<b>20</b>

# 1 Electrical ratings

Table 2: Absolute maximum ratings

Symbol	Parameter	Value		Unit
		TO-247 TO-3P	TO-3PF	
V <sub>CES</sub>	Collector-emitter voltage (V <sub>GE</sub> = 0 V)	600		V
I <sub>C</sub>	Continuous collector current at T <sub>C</sub> = 25 °C	80		A
	Continuous collector current at T <sub>C</sub> = 100 °C	40		A
I <sub>CP</sub> <sup>(1)</sup>	Pulsed collector current	160		A
V <sub>GE</sub>	Gate-emitter voltage	±20		V
I <sub>F</sub>	Continuous forward current at T <sub>C</sub> = 25 °C	80		A
	Continuous forward current at T <sub>C</sub> = 100 °C	40		A
I <sub>FP</sub> <sup>(1)</sup>	Pulsed forward current	160		A
P <sub>TOT</sub>	Total dissipation at T <sub>C</sub> = 25 °C	283	62.5	W
V <sub>ISO</sub>	Insulation withstand voltage (RMS) from all three leads to external heat sink (t = 1 s, T <sub>C</sub> = 25 °C)		3.5	kV
T <sub>STG</sub>	Storage temperature range	-55 to 150		°C
T <sub>J</sub>	Operating junction temperature range	-55 to 175		°C

**Notes:**

<sup>(1)</sup>Pulse width is limited by maximum junction temperature.

Table 3: Thermal data

Symbol	Parameter	Value		Unit
		TO-247 TO-3P	TO-3PF	
R <sub>thJC</sub>	Thermal resistance junction-case IGBT	0.53	2.4	°C/W
R <sub>thJC</sub>	Thermal resistance junction-case diode	1.14	2.6	°C/W
R <sub>thJA</sub>	Thermal resistance junction-ambient	50		°C/W

## 2 Electrical characteristics

$T_J = 25\text{ °C}$  unless otherwise specified

**Table 4: Static characteristics**

Symbol	Parameter	Test conditions	Min.	Typ.	Max.	Unit
$V_{(BR)CES}$	Collector-emitter breakdown voltage	$V_{GE} = 0\text{ V}$ , $I_C = 2\text{ mA}$	600			V
$V_{CE(sat)}$	Collector-emitter saturation voltage	$V_{GE} = 15\text{ V}$ , $I_C = 40\text{ A}$		1.8	2.3	V
		$V_{GE} = 15\text{ V}$ , $I_C = 40\text{ A}$ , $T_J = 125\text{ °C}$		2.15		
		$V_{GE} = 15\text{ V}$ , $I_C = 40\text{ A}$ , $T_J = 175\text{ °C}$		2.35		
$V_F$	Forward on-voltage	$I_F = 40\text{ A}$		1.7	2.45	V
		$I_F = 40\text{ A}$ , $T_J = 125\text{ °C}$		1.4		
		$I_F = 40\text{ A}$ , $T_J = 175\text{ °C}$		1.3		
$V_{GE(th)}$	Gate threshold voltage	$V_{CE} = V_{GE}$ , $I_C = 1\text{ mA}$	5	6	7	V
$I_{CES}$	Collector cut-off current	$V_{GE} = 0\text{ V}$ , $V_{CE} = 0\text{ V}$			25	$\mu\text{A}$
$I_{GES}$	Gate-emitter leakage current	$V_{CE} = 0\text{ V}$ , $V_{GE} = \pm 20\text{ V}$			$\pm 250$	nA

**Table 5: Dynamic characteristics**

Symbol	Parameter	Test conditions	Min.	Typ.	Max.	Unit
$C_{ies}$	Input capacitance	$V_{CE} = 25\text{ V}$ , $f = 1\text{ MHz}$ , $V_{GE} = 0\text{ V}$	-	5400	-	pF
$C_{oes}$	Output capacitance		-	220	-	pF
$C_{res}$	Reverse transfer capacitance		-	180	-	pF
$Q_g$	Total gate charge	$V_{CC} = 480\text{ V}$ , $I_C = 40\text{ A}$ , $V_{GE} = 0\text{ to }15\text{ V}$ (see <a href="#">Figure 35: "Gate charge test circuit"</a> )	-	226	-	nC
$Q_{ge}$	Gate-emitter charge		-	38	-	nC
$Q_{gc}$	Gate-collector charge		-	95	-	nC

Table 6: IGBT switching characteristics (inductive load)

Symbol	Parameter	Test conditions	Min.	Typ.	Max.	Unit
$t_{d(on)}$	Turn-on delay time	$V_{CE} = 400\text{ V}$ , $I_C = 40\text{ A}$ , $R_G = 10\ \Omega$ , $V_{GE} = 15\text{ V}$ (see <a href="#">Figure 34: "Test circuit for inductive load switching"</a> )	-	52	-	ns
$t_r$	Current rise time		-	17	-	ns
$(di/dt)_{on}$	Turn-on current slope		-	1850	-	A/ $\mu$ s
$t_{d(off)}$	Turn-off delay time		-	208	-	ns
$t_f$	Current fall time		-	20	-	ns
$E_{on}^{(1)}$	Turn-on switching energy		-	456	-	$\mu$ J
$E_{off}^{(2)}$	Turn-off switching energy		-	411	-	$\mu$ J
$E_{ts}$	Total switching energy		-	867	-	$\mu$ J
$t_{d(on)}$	Turn-on delay time	$V_{CE} = 400\text{ V}$ , $I_C = 40\text{ A}$ , $R_G = 10\ \Omega$ , $V_{GE} = 15\text{ V}$ , $T_J = 175\text{ }^\circ\text{C}$ (see <a href="#">Figure 34: "Test circuit for inductive load switching"</a> )	-	52	-	ns
$t_r$	Current rise time		-	21	-	ns
$(di/dt)_{on}$	Turn-on current slope		-	1538	-	A/ $\mu$ s
$t_{d(off)}$	Turn-off-delay time		-	220	-	ns
$t_f$	Current fall time		-	21	-	ns
$E_{on}^{(1)}$	Turn-on switching energy		-	1330	-	$\mu$ J
$E_{off}^{(2)}$	Turn-off switching energy		-	560	-	$\mu$ J
$E_{ts}$	Total switching energy		-	1890	-	$\mu$ J

Notes:

(1)Including the reverse recovery of the diode.

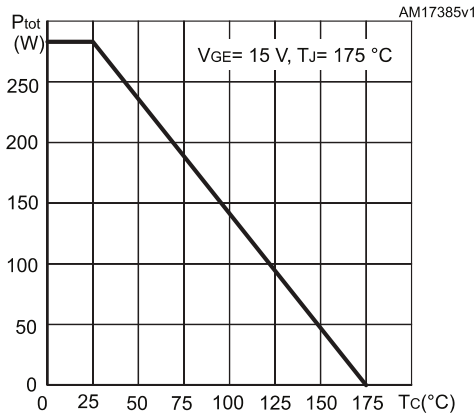
(2)Including the tail of the collector current.

Table 7: Diode switching characteristics (inductive load)

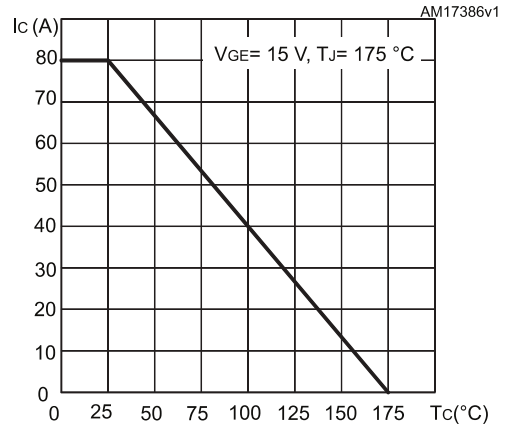
Symbol	Parameter	Test conditions	Min.	Typ.	Max.	Unit
$t_{rr}$	Reverse recovery time	$I_F = 40\text{ A}$ , $V_R = 400\text{ V}$ , $V_{GE} = 15\text{ V}$ , $di/dt = 1000\text{ A}/\mu\text{s}$ (see <a href="#">Figure 34: "Test circuit for inductive load switching"</a> )	-	41	-	ns
$Q_{rr}$	Reverse recovery charge		-	440	-	nC
$I_{rrm}$	Reverse recovery current		-	21.6	-	A
$dl_{rr}/dt$	Peak rate of fall of reverse recovery current during $t_b$		-	1363	-	A/ $\mu$ s
$E_{rr}$	Reverse recovery energy		-	151	-	$\mu$ J
$t_{rr}$	Reverse recovery time	$I_F = 40\text{ A}$ , $V_R = 400\text{ V}$ , $V_{GE} = 15\text{ V}$ , $di/dt = 1000\text{ A}/\mu\text{s}$ , $T_J = 175\text{ }^\circ\text{C}$ (see <a href="#">Figure 34: "Test circuit for inductive load switching"</a> )	-	109	-	ns
$Q_{rr}$	Reverse recovery charge		-	2400	-	nC
$I_{rrm}$	Reverse recovery current		-	44.4	-	A
$dl_{rr}/dt$	Peak rate of fall of reverse recovery current during $t_b$		-	670	-	A/ $\mu$ s
$E_{rr}$	Reverse recovery energy		-	718	-	$\mu$ J

## 2.1 Electrical characteristics curves

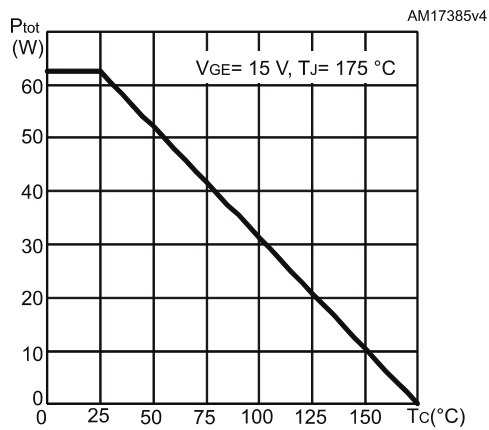
**Figure 2: Power dissipation vs case temperature for TO-247 and TO-3P**



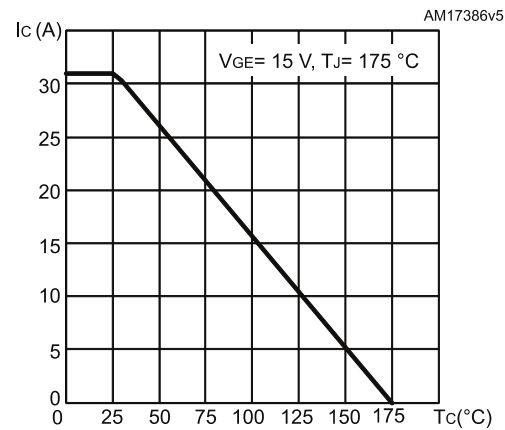
**Figure 3: Collector current vs case temperature for TO-247 and TO-3P**



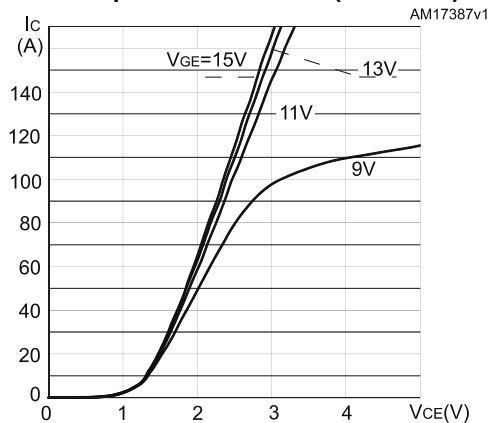
**Figure 4: Power dissipation vs case temperature for TO-3PF**



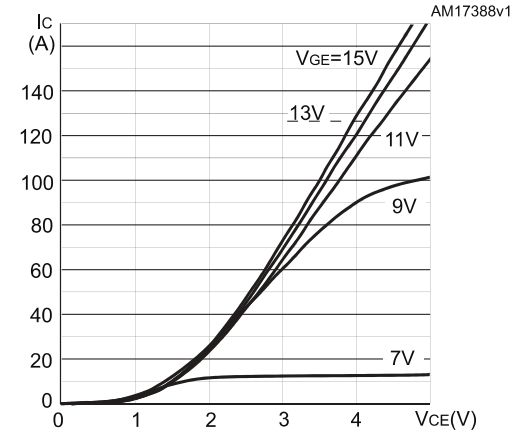
**Figure 5: Collector current vs case temperature for TO-3PF**

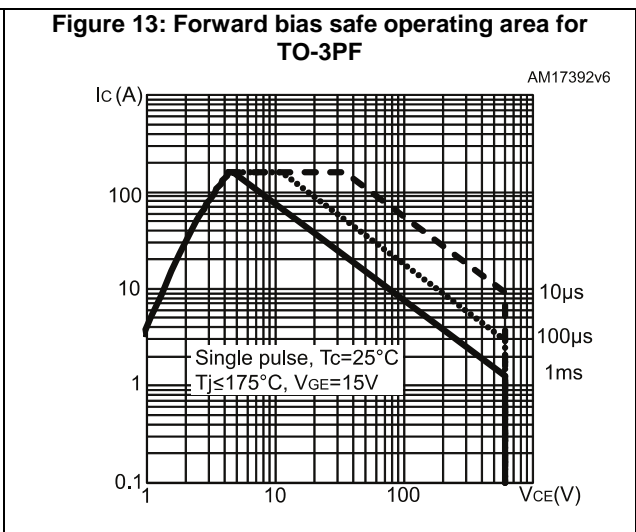
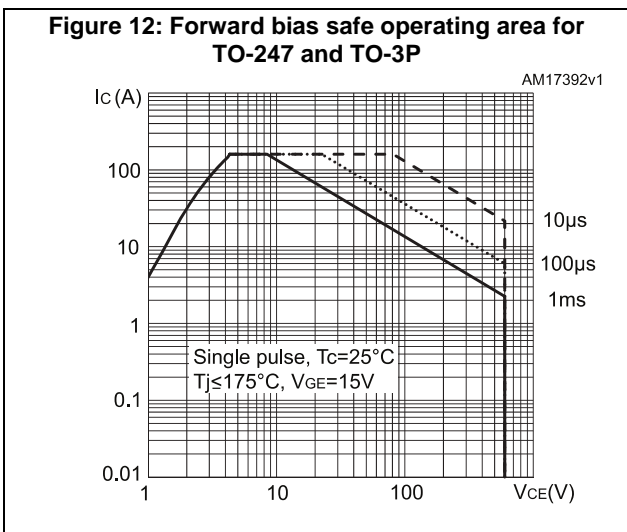
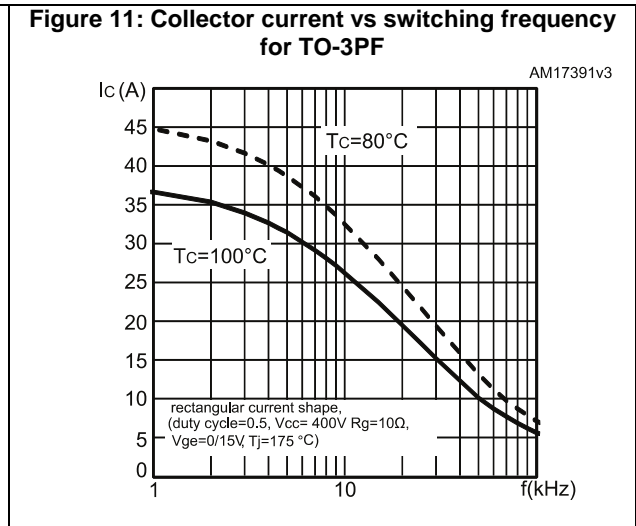
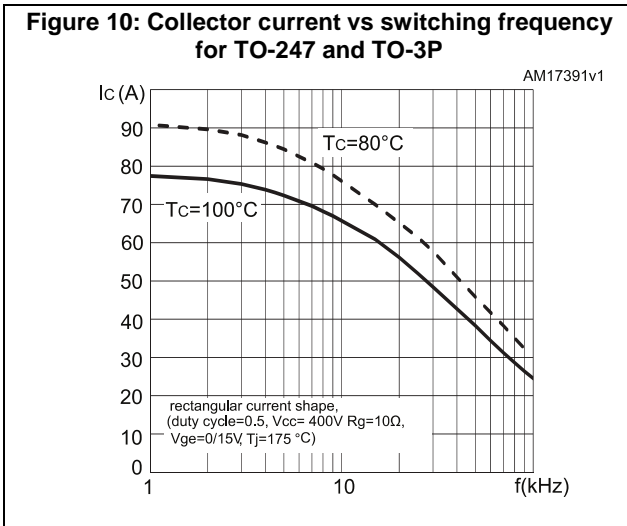
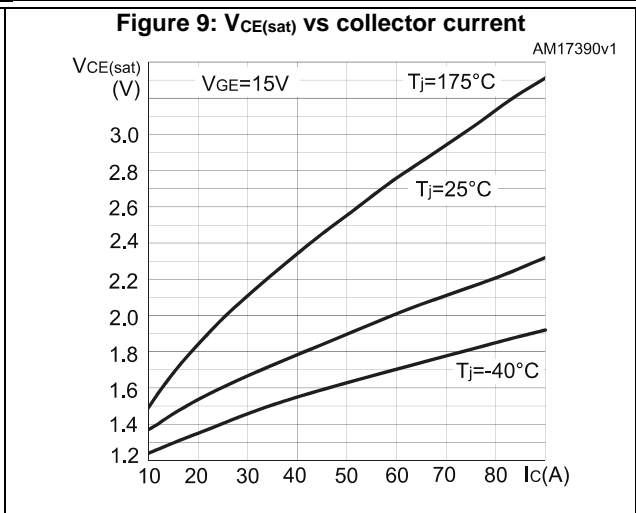
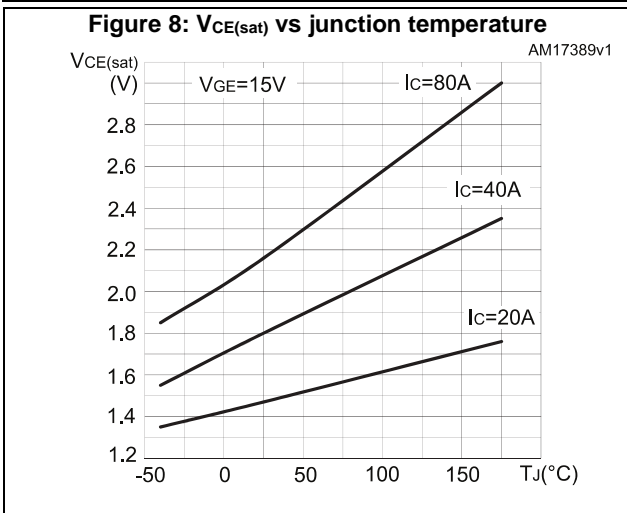


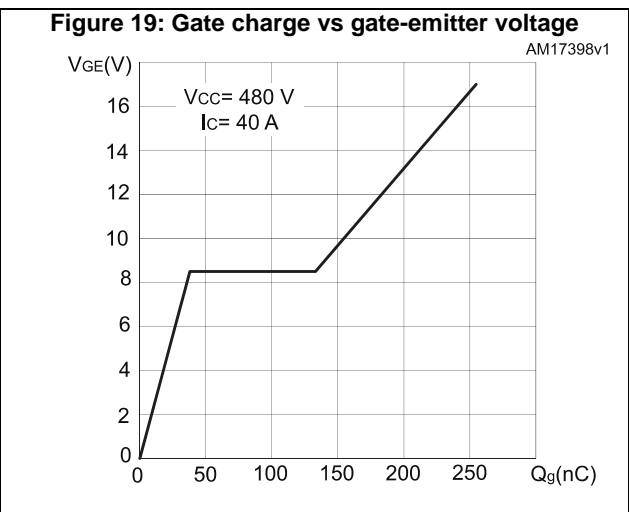
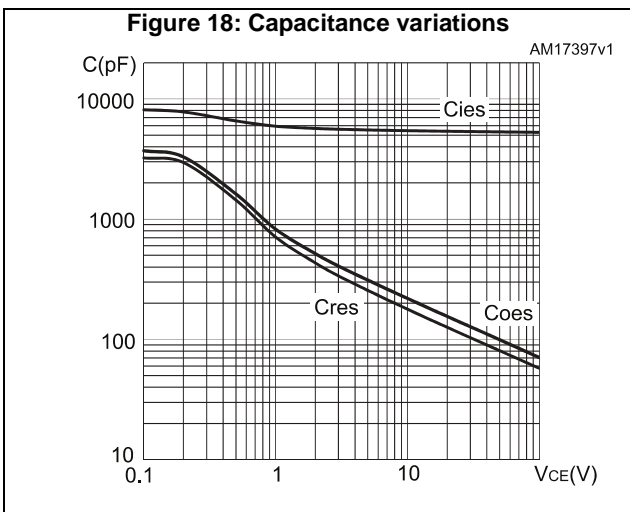
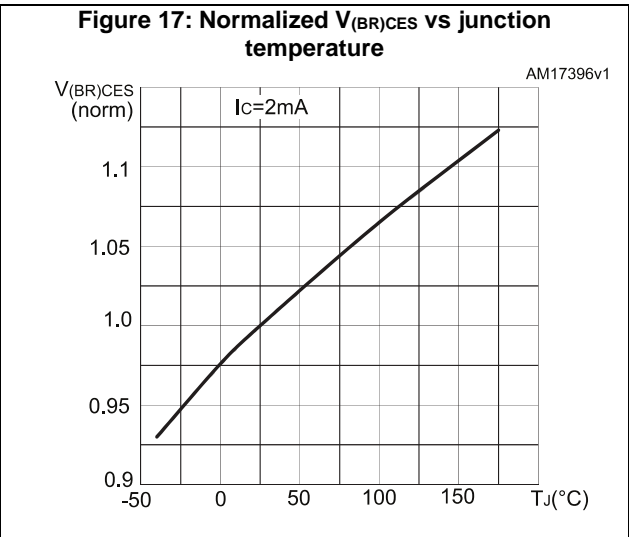
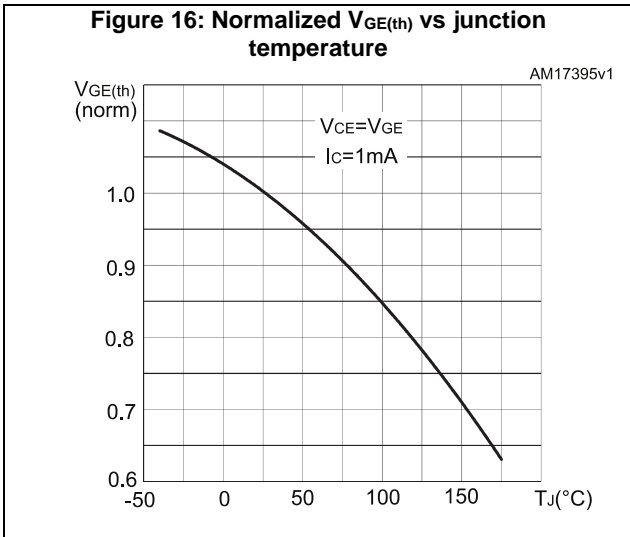
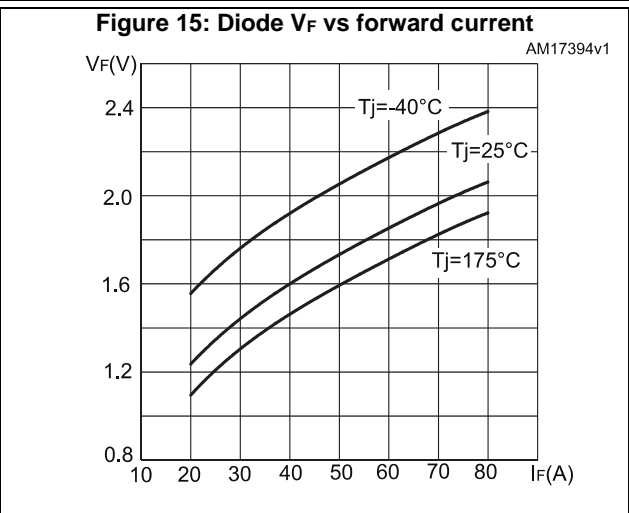
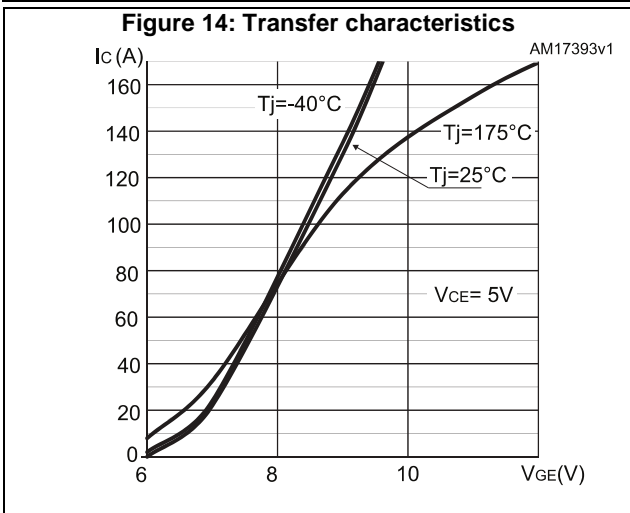
**Figure 6: Output characteristics (TJ = 25 °C)**



**Figure 7: Output characteristics (TJ = 175 °C)**









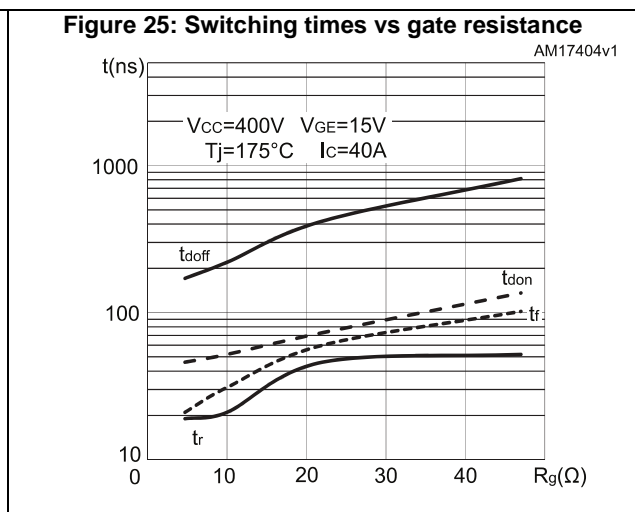
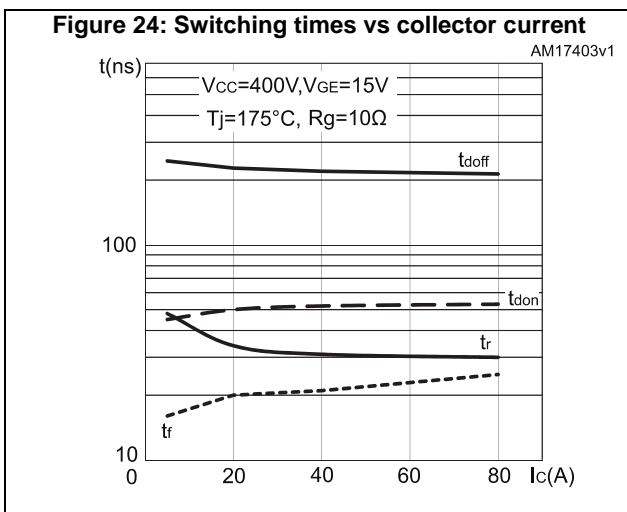
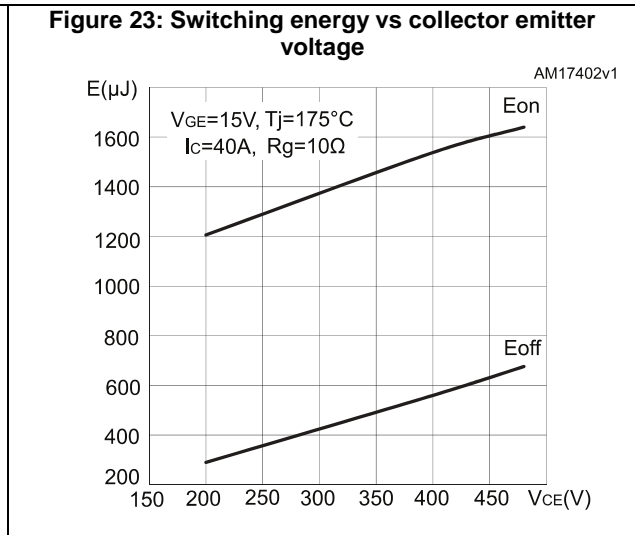
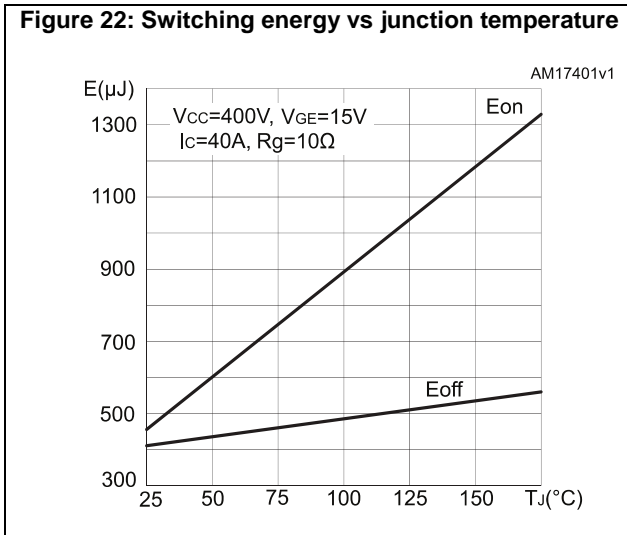
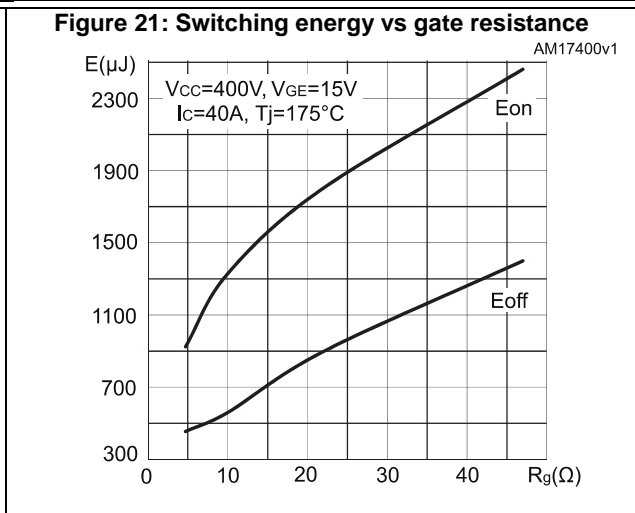
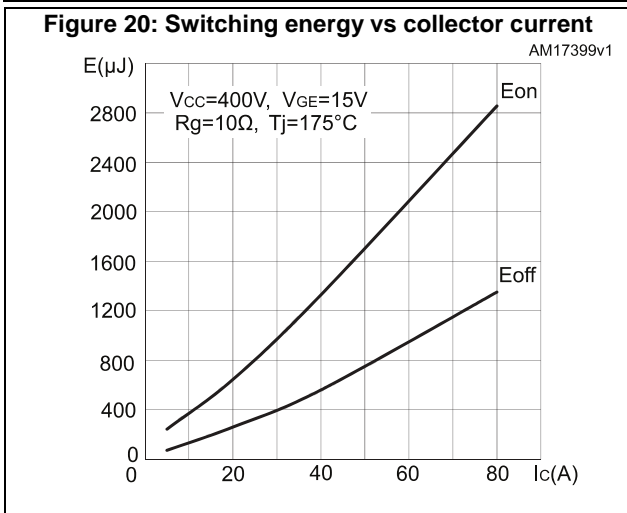


Figure 26: Reverse recovery current vs diode current slope

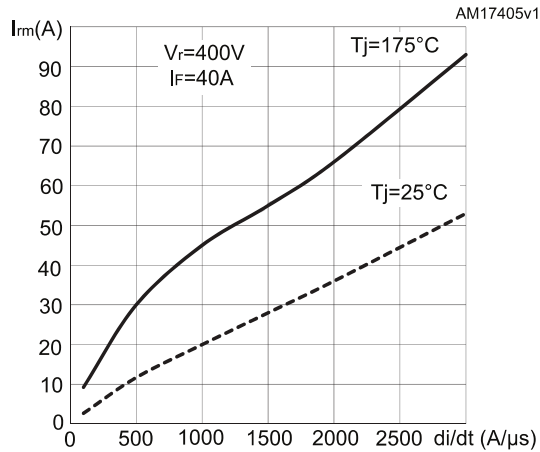


Figure 27: Reverse recovery time vs diode current slope

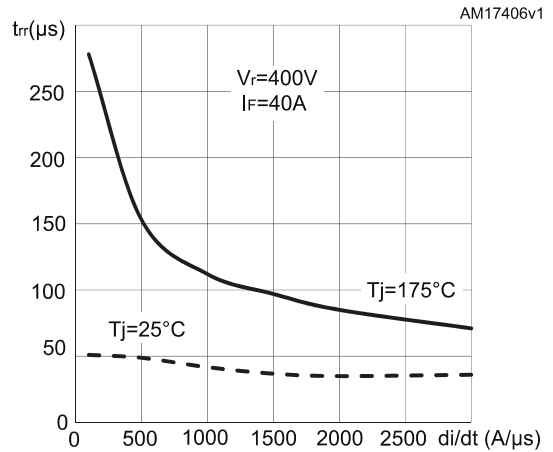


Figure 28: Reverse recovery charge vs diode current slope

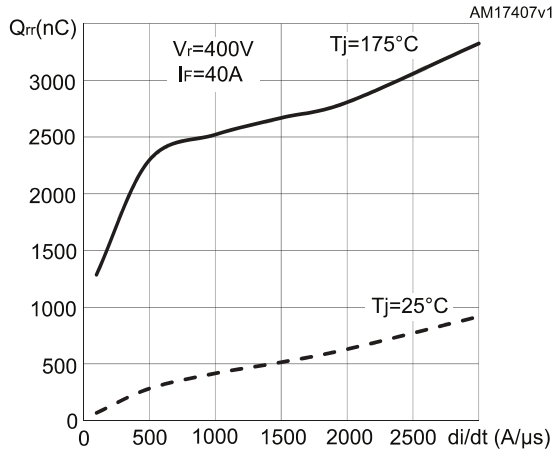


Figure 29: Reverse recovery energy vs diode current slope

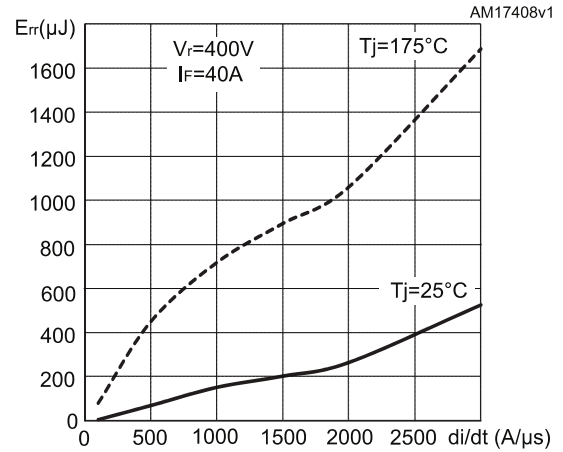


Figure 30: Thermal impedance for IGBT in TO-247 and TO-3P

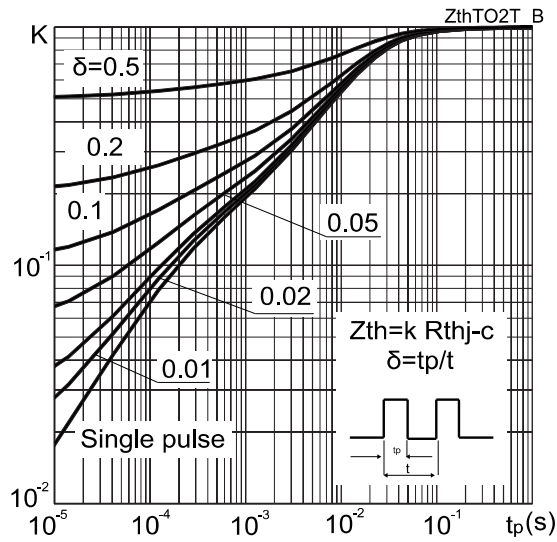


Figure 31: Thermal impedance for IGBT in TO-3PF

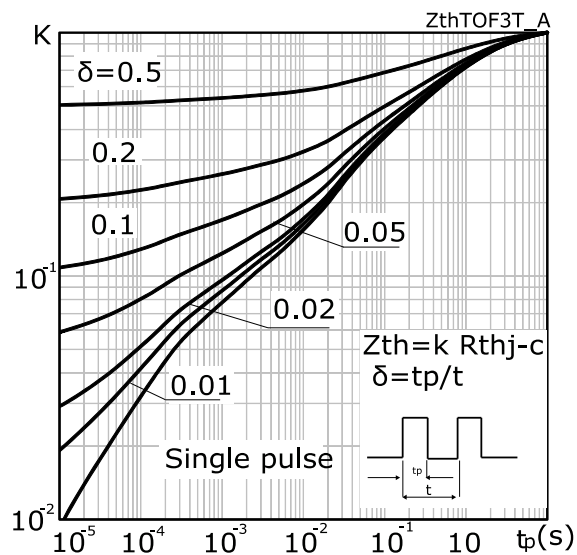


Figure 32: Thermal impedance for diode in TO-247 and TO-3P

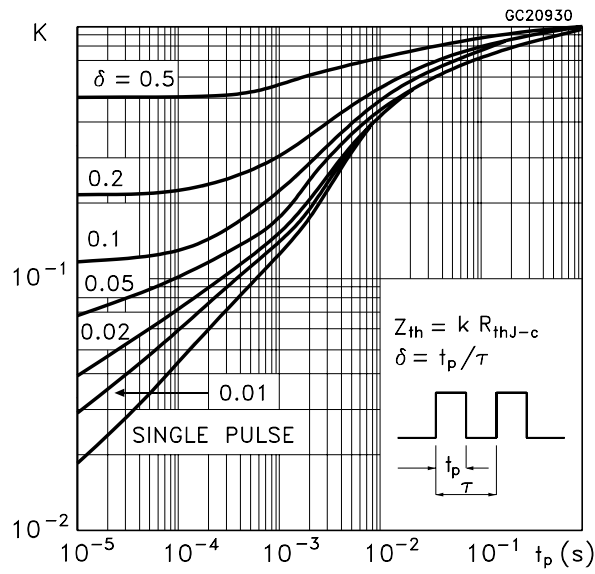
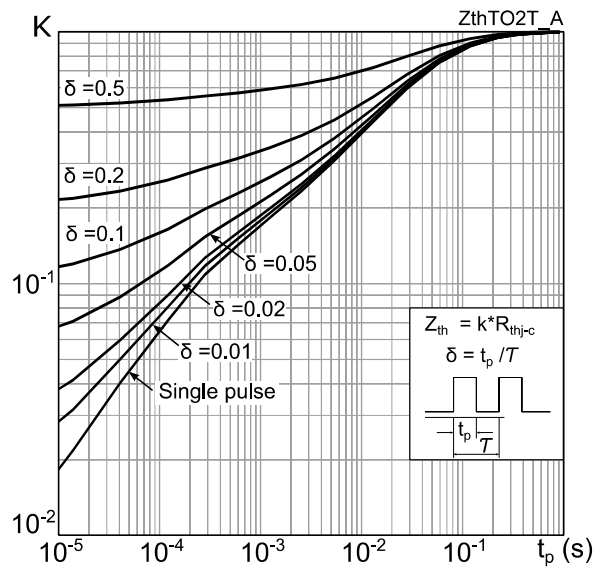
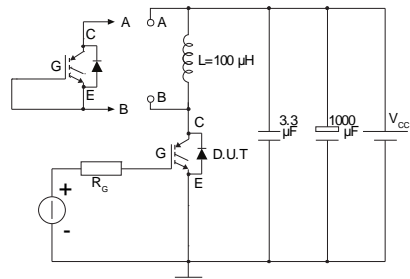


Figure 33: Thermal impedance for diode in TO-3PF



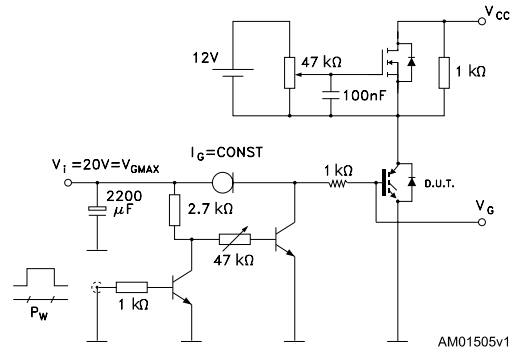
### 3 Test circuits

Figure 34: Test circuit for inductive load switching



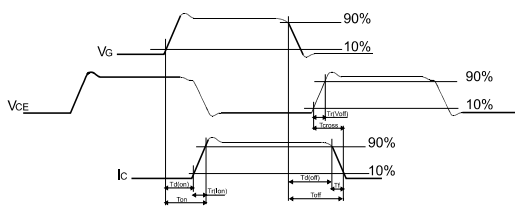
AM01504v1

Figure 35: Gate charge test circuit



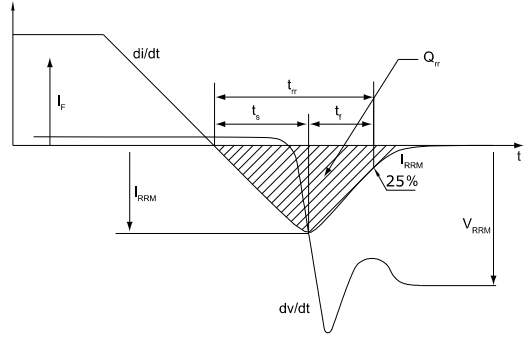
AM01505v1

Figure 36: Switching waveform



AM01506v1

Figure 37: Diode reverse recovery waveform



AM01507v1

## 4 Package information

In order to meet environmental requirements, ST offers these devices in different grades of ECOPACK® packages, depending on their level of environmental compliance. ECOPACK® specifications, grade definitions and product status are available at: [www.st.com](http://www.st.com). ECOPACK® is an ST trademark.

### 4.1 TO-3PF package information

Figure 38: TO-3PF package outline

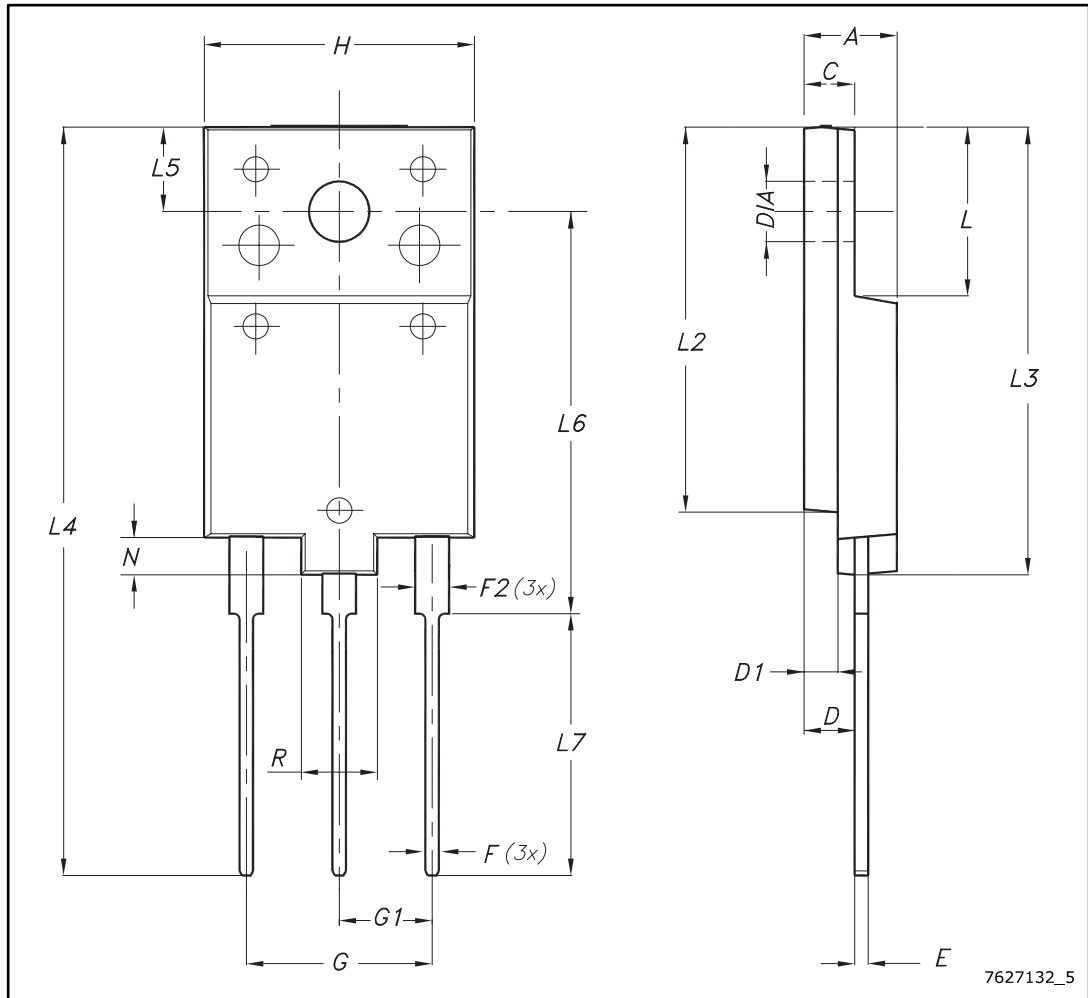


Table 8: TO-3PF mechanical data

Dim.	mm		
	Min.	Typ.	Max.
A	5.30		5.70
C	2.80		3.20
D	3.10		3.50
D1	1.80		2.20
E	0.80		1.10
F	0.65		0.95
F2	1.80		2.20
G	10.30		11.50
G1		5.45	
H	15.30		15.70
L	9.80	10	10.20
L2	22.80		23.20
L3	26.30		26.70
L4	43.20		44.40
L5	4.30		4.70
L6	24.30		24.70
L7	14.60		15
N	1.80		2.20
R	3.80		4.20
Dia	3.40		3.80

### 4.2 TO-247 package information

Figure 39: TO-247 package outline

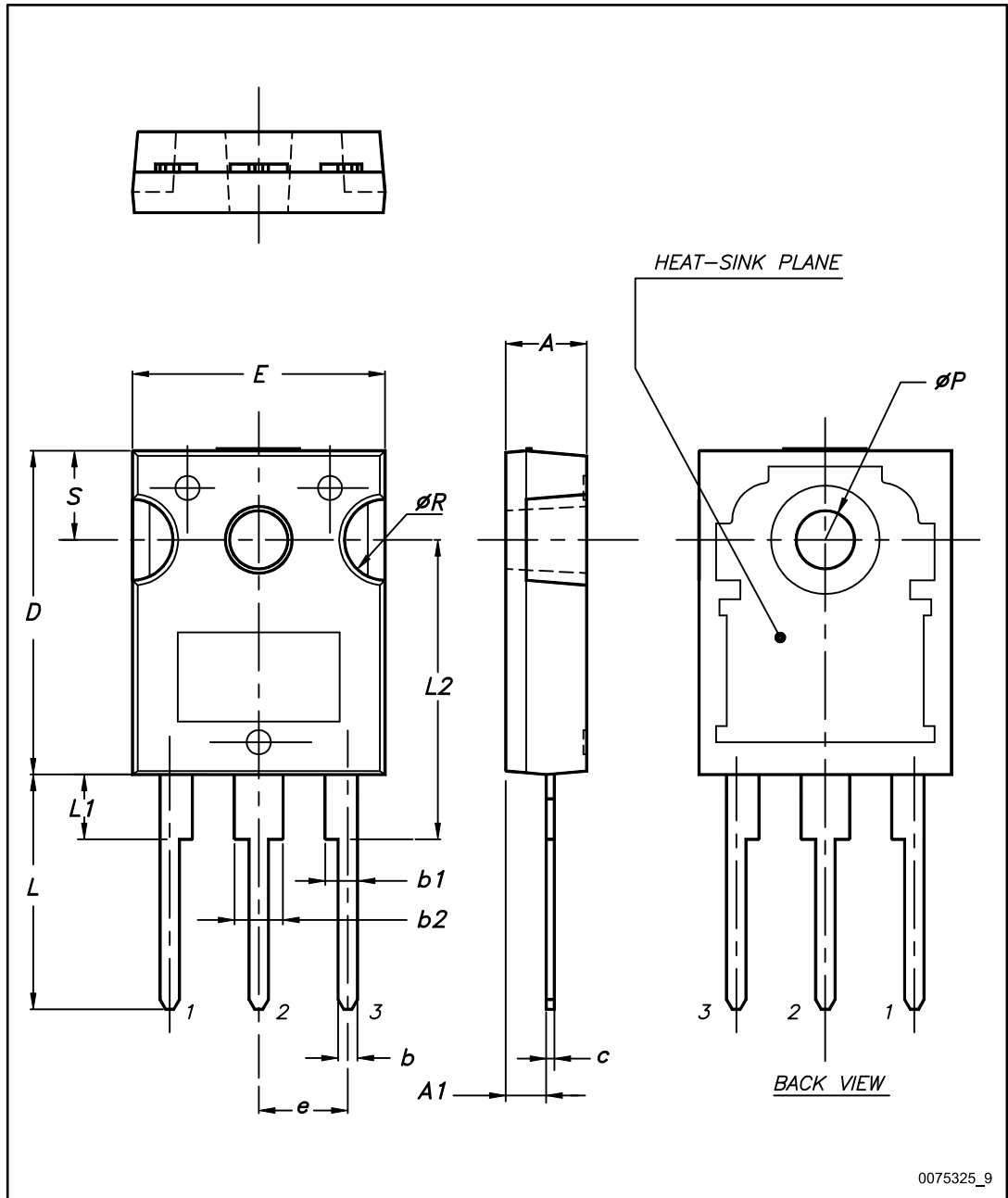




Table 9: TO-247 package mechanical data

Dim.	mm		
	Min.	Typ.	Max.
A	4.85		5.15
A1	2.20		2.60
b	1.0		1.40
b1	2.0		2.40
b2	3.0		3.40
c	0.40		0.80
D	19.85		20.15
E	15.45		15.75
e	5.30	5.45	5.60
L	14.20		14.80
L1	3.70		4.30
L2		18.50	
ØP	3.55		3.65
ØR	4.50		5.50
S	5.30	5.50	5.70

### 4.3 TO-3P package information

Figure 40: TO-3P package outline

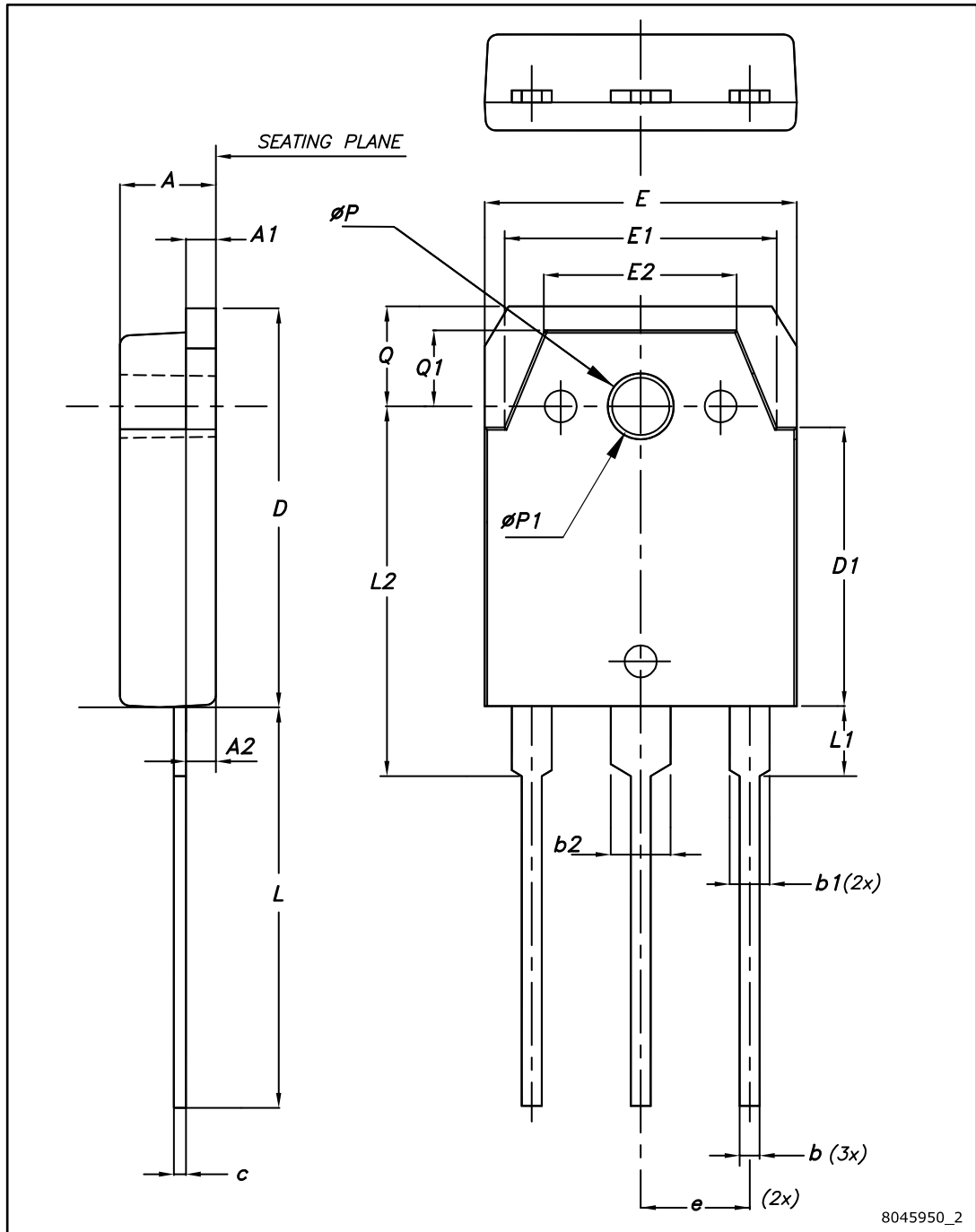


Table 10: TO-3P package mechanical data

Dim.	mm		
	Min.	Typ.	Max.
A	4.60	4.80	5.00
A1	1.45	1.50	1.65
A2	1.20	1.40	1.60
b	0.80	1.00	1.20
b1	1.80	2.00	2.20
b2	2.80	3.00	3.20
c	0.55	0.60	0.75
D	19.70	19.90	20.10
D1	13.70	13.90	14.10
E	15.40	15.60	15.80
E1	13.40	13.60	13.80
E2	9.40	9.60	9.90
e	5.15	5.45	5.75
L	19.80	20.00	20.20
L1	3.30	3.50	3.70
L2	18.20	18.40	18.60
ØP	3.30	3.40	3.50
ØP1	3.10	3.20	3.30
Q	4.80	5.00	5.20
Q1	3.60	3.80	4

## 5 Revision history

Table 11: Document revision history

Date	Revision	Changes
20-Mar-2013	1	Initial release
17-Apr-2013	2	Document status promoted from preliminary data to production data. Added: <i>Section 2.1: Electrical characteristics (curves)</i>
04-Jun-2013	3	Added minimum and maximum values for $V_{GE(th)}$ in <i>Table 4: Static characteristics</i> .
11-Sep-2013	4	Updated $V_F$ value in <i>Table 4: Static characteristics</i> .
08-Oct-2013	5	Updated title, features and description in cover page.
10-Jan-2014	6	Updated <i>Figure 8: <math>V_{CE(sat)}</math> vs. junction temperature</i> , <i>Figure 15: Diode <math>V_F</math> vs. forward current</i> and <i>Figure 16: Normalized <math>V_{GE(th)}</math> vs junction temperature</i> .
03-Mar-2014	7	Updated test conditions in <i>Table 7: Diode switching characteristics (inductive load)</i> .
23-Apr-2014	8	Added new device in TO-3PF. Updated <i>Table 1: Device summary</i> , <i>Table 2: Absolute maximum ratings</i> , <i>Table 3: Thermal data</i> and <i>Section 4: Package mechanical data</i> . Added <i>Figure 4: Power dissipation vs. case temperature for TO-3PF</i> , <i>Figure 5: Collector current vs. case temperature for TO-3PF</i> , <i>Figure 11: Collector current vs. switching frequency for TO-3PF</i> and <i>Figure 12: Forward bias safe operating area for TO-247 and TO-3P</i> . Minor text changes.
27-Oct-2017	9	Updated <i>Table 3: "Thermal data"</i> . Added <i>Figure 33: "Thermal impedance for diode in TO-3PF"</i> . Updated <i>Section 4: "Package information"</i> . Minor text changes

**IMPORTANT NOTICE – PLEASE READ CAREFULLY**

STMicroelectronics NV and its subsidiaries (“ST”) reserve the right to make changes, corrections, enhancements, modifications, and improvements to ST products and/or to this document at any time without notice. Purchasers should obtain the latest relevant information on ST products before placing orders. ST products are sold pursuant to ST’s terms and conditions of sale in place at the time of order acknowledgement.

Purchasers are solely responsible for the choice, selection, and use of ST products and ST assumes no liability for application assistance or the design of Purchasers’ products.

No license, express or implied, to any intellectual property right is granted by ST herein.

Resale of ST products with provisions different from the information set forth herein shall void any warranty granted by ST for such product.

ST and the ST logo are trademarks of ST. All other product or service names are the property of their respective owners.

Information in this document supersedes and replaces information previously supplied in any prior versions of this document.

© 2017 STMicroelectronics – All rights reserved



Компания «ЭлектроПласт» предлагает заключение долгосрочных отношений при поставках импортных электронных компонентов на взаимовыгодных условиях!

Наши преимущества:

- Оперативные поставки широкого спектра электронных компонентов отечественного и импортного производства напрямую от производителей и с крупнейших мировых складов;
- Поставка более 17-ти миллионов наименований электронных компонентов;
- Поставка сложных, дефицитных, либо снятых с производства позиций;
- Оперативные сроки поставки под заказ (от 5 рабочих дней);
- Экспресс доставка в любую точку России;
- Техническая поддержка проекта, помощь в подборе аналогов, поставка прототипов;
- Система менеджмента качества сертифицирована по Международному стандарту ISO 9001;
- Лицензия ФСБ на осуществление работ с использованием сведений, составляющих государственную тайну;
- Поставка специализированных компонентов (Xilinx, Altera, Analog Devices, Intersil, Interpoint, Microsemi, Aeroflex, Peregrine, Syfer, Eurofarad, Texas Instrument, Miteq, Cobham, E2V, MA-COM, Hittite, Mini-Circuits, General Dynamics и др.);

Помимо этого, одним из направлений компании «ЭлектроПласт» является направление «Источники питания». Мы предлагаем Вам помощь Конструкторского отдела:

- Подбор оптимального решения, техническое обоснование при выборе компонента;
- Подбор аналогов;
- Консультации по применению компонента;
- Поставка образцов и прототипов;
- Техническая поддержка проекта;
- Защита от снятия компонента с производства.



#### Как с нами связаться

**Телефон:** 8 (812) 309 58 32 (многоканальный)

**Факс:** 8 (812) 320-02-42

**Электронная почта:** [org@eplast1.ru](mailto:org@eplast1.ru)

**Адрес:** 198099, г. Санкт-Петербург, ул. Калинина, дом 2, корпус 4, литера А.