

## 1000W, 10V - 100V Surface Mount Transient Voltage Suppressor

### FEATURES FEATURES

- Low profile package
- Ideal for automated placement
- Glass passivated junction
- Built-in strain relief
- Excellent clamping capability
- Fast response time: Typically less than 1.0ps from 0 volt to BV min
- Compliant to RoHS Directive 2011/65/EU and in accordance to WEEE 2002/96/EC
- Halogen-free according to IEC 61249-2-21

### APPLICATIONS

- Switching mode power supply (SMPS)
- Adapters
- TV
- Monitor

### MECHANICAL DATA

- Case: DO-214AA (SMB)
- Molding compound meets UL 94V-0 flammability rating
- Moisture sensitivity level: level 1, per J-STD-020
- Part no. with suffix "H" means AEC-Q101 qualified
- Packing code with suffix "G" means green compound (halogen-free)
- Terminal: Matte tin plated leads, solderable per J-STD-002
- Meet JESD 201 class 2 whisker test
- Polarity: As marked
- Weight: 0.11 g (approximately)

KEY PARAMETERS		
PARAMETER	VALUE	UNIT
$V_{WM}$	8.55 – 85.5	V
$V_{BR}$ (uni-directional)	9.5 - 105	V
$V_{BR}$ (bi-directional)	9.5 - 105	V
$P_{PPSM}$	1000	W
$T_{J\ MAX}$	175	°C
Package	DO-214AA (SMB)	
Configuration	Single die	



DO-214AA (SMB)

ABSOLUTE MAXIMUM RATINGS ( $T_A = 25^\circ\text{C}$ unless otherwise noted)			
PARAMETER	SYMBOL	PART NUMBER	UNIT
Non-repetitive peak impulse power dissipation with 10/1000us waveform	$P_{PPSM}$	1000	W
Steady state power dissipation at $T_A=25^\circ\text{C}$ <sup>(1)</sup>	$P_{tot}$	5	W
Peak forward surge current, 8.3 ms single half sine-wave superimposed on rated load	$I_{FSM}$	100	A
Forward Voltage @ $I_F=50\text{A}$ for Uni-directional only <sup>(2)</sup>	$V_F$	3.5/5.0	V
Junction temperature	$T_J$	-55 to +175	°C
Storage temperature	$T_{STG}$	-55 to +175	°C

#### Notes:

1. Non-repetitive Current Pulse Per Fig. 3 and Derated above  $T_A=25^\circ\text{C}$  Per Fig. 2
2.  $V_F=3.5\text{V}$  for Devices of  $V_{BR} \leq 50\text{V}$  and  $V_F=5.0\text{V}$  Max. for Devices  $V_{BR} > 50\text{V}$

Devices for Bipolar Applications

1. For Bidirectional use CA suffix

<b>THERMAL PERFORMANCE</b>			
<b>PARAMETER</b>	<b>SYMBOL</b>	<b>LIMIT</b>	<b>UNIT</b>
Junction-to-lead thermal resistance	$R_{\theta JL}$	20	$^{\circ}\text{C/W}$
Junction-to-ambient thermal resistance	$R_{\theta JA}$	100	$^{\circ}\text{C/W}$

**ELECTRICAL SPECIFICATIONS** ( $T_A = 25^{\circ}\text{C}$  unless otherwise noted)

Device	Device Marking Code	Breakdown Voltage $V_{BR@I_T}$ (V)		Test Current $I_T$ (mA)	Stand-Off Voltage @ $V_{WM}$ (V)	Maximum Reverse Leakage @ $V_{WM}$ ( $\mu\text{A}$ )	Maximum Peak imp current $I_{PP}$ (A) (Note 2)	Maximum Clamping Voltage $V_C@I_{PP}$ (V)
		Min.	Max.					
1KSMB10A	A10E	9.5	10.5	1.0	8.55	10.0	69.0	14.5
1KSMB10CA	N10E							
1KSMB11A	A10F	10.5	11.6	1.0	9.40	5.0	64.1	15.6
1KSMB11CA	N10F							
1KSMB12A	A10G	11.4	12.6	1.0	10.2	5.0	59.9	16.7
1KSMB12CA	N10G							
1KSMB13A	A10H	12.4	13.7	1.0	11.1	5.0	54.9	18.2
1KSMB13CA	N10H							
1KSMB15A	A10I	14.3	15.8	1.0	12.8	5.0	47.2	21.2
1KSMB15CA	N10I							
1KSMB16A	A10J	15.2	16.8	1.0	13.6	1.0	44.4	22.5
1KSMB16CA	N10J							
1KSMB18A	A10K	17.1	18.9	1.0	15.3	1.0	39.2	25.5
1KSMB18CA	N10K							
1KSMB20A	A10L	19.0	21.0	1.0	17.1	1.0	36.1	27.7
1KSMB20CA	N10L							
1KSMB22A	A10M	20.9	23.1	1.0	18.8	1.0	32.7	30.6
1KSMB22CA	N10M							
1KSMB24A	A10N	22.8	25.2	1.0	20.5	1.0	30.1	33.2
1KSMB24CA	N10N							
1KSMB27A	A10O	25.7	28.4	1.0	23.1	1.0	26.7	37.5
1KSMB27CA	N10O							
1KSMB30A	A10P	28.5	31.5	1.0	25.6	1.0	24.2	41.4
1KSMB30CA	N10P							
1KSMB33A	A10Q	31.4	34.7	1.0	28.2	1.0	21.9	45.7
1KSMB33CA	N10Q							
1KSMB36A	A10R	34.2	37.8	1.0	30.8	1.0	20.0	49.9
1KSMB36CA	N10R							
1KSMB39A	A10S	37.1	41.0	1.0	33.3	1.0	18.6	53.9
1KSMB39CA	N10S							
1KSMB43A	A10T	40.9	45.2	1.0	36.8	1.0	16.9	59.3
1KSMB43CA	N10T							
1KSMB47A	A10U	44.7	49.4	1.0	40.2	1.0	15.4	64.8
1KSMB47CA	N10U							
1KSMB51A	A10V	48.5	53.6	1.0	43.6	1.0	14.3	70.1
1KSMB51CA	N10V							
1KSMB56A	A10W	53.2	58.8	1.0	47.8	1.0	13.0	77.0
1KSMB56CA	N10W							
1KSMB62A	A10X	58.9	65.1	1.0	53.0	1.0	11.8	85.0
1KSMB62CA	N10X							
1KSMB68A	A10Y	64.6	71.4	1.0	58.1	1.0	10.9	92.0
1KSMB68CA	N10Y							

**ELECTRICAL SPECIFICATIONS** ( $T_A = 25^\circ\text{C}$  unless otherwise noted)

Device	Device Marking Code	Breakdown voltage $V_{BR}@I_T$ (V) (Note 1)		Test current $I_T$ (mA)	Stand-Off Voltage $@V_{WM}$ (V)	Maximum Reverse leakage $@V_{WM}$ ( $\mu\text{A}$ )	Maximum peak impulse current $I_{PP}$ (A) (Note 2)	Maximum clamping voltage $V_C@I_{PP}$ (V)
		Min.	Max.					
1KSMB75A	A10Z	71.3	78.8	1.0	64.1	1.0	9.7	103
1KSMB75CA	N10Z							
1KSMB82A	B10A	77.9	86.1	1.0	70.1	1.0	8.8	113
1KSMB82CA	O10A							
1KSMB91A	B10B	86.5	95.5	1.0	77.8	1.0	8.0	125
1KSMB91CA	O10B							
1KSMB100A	B10C	95	105	1.0	85.5	1.0	7.3	137
1KSMB100CA	O10C							

**Notes:**

- $V_{BR}$  measure after  $I_T$  applied for  $300\mu\text{s}$ ,  $I_T$ =square wave pulse or equivalent.
- All terms and symbols are consistent with ANSI/IEEE C62.35.
- For Bidirectional use CA suffix

**ORDERING INFORMATION**

PART NO.	PART NO. SUFFIX	PACKING CODE	PACKING CODE SUFFIX(*)	PACKAGE	PACKING
1KSMBxxxx (Note 1)	H	R5	G	SMB	850 / 7" Plastic reel
		R4		SMB	3,000 / 13" Paper reel
		M4		SMB	3,000 / 13" Plastic reel

**Note :**

- "xxxx" defines voltage from 10V (1KSMB10A) to 100V (1KSMB100CA)

\*: Optional available

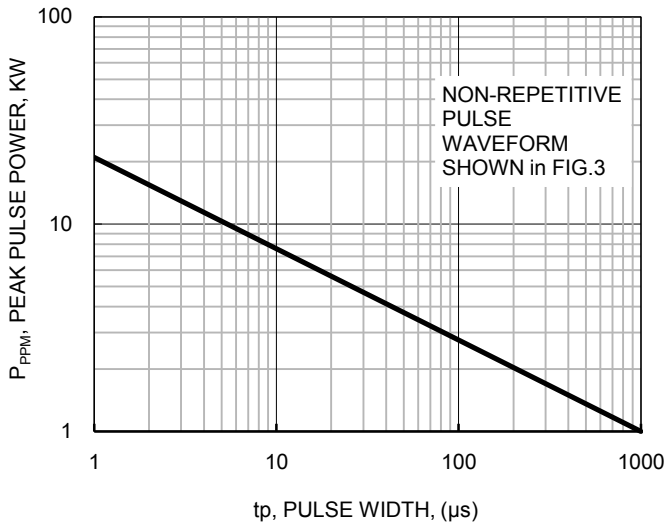
**EXAMPLE P/N**

EXAMPLE P/N	PART NO.	PART NO. SUFFIX	PACKING CODE	PACKING CODE SUFFIX	DESCRIPTION
1KSMB39AHR5G	1KSMB39A	H	R5	G	AEC-Q101 qualified Green compound

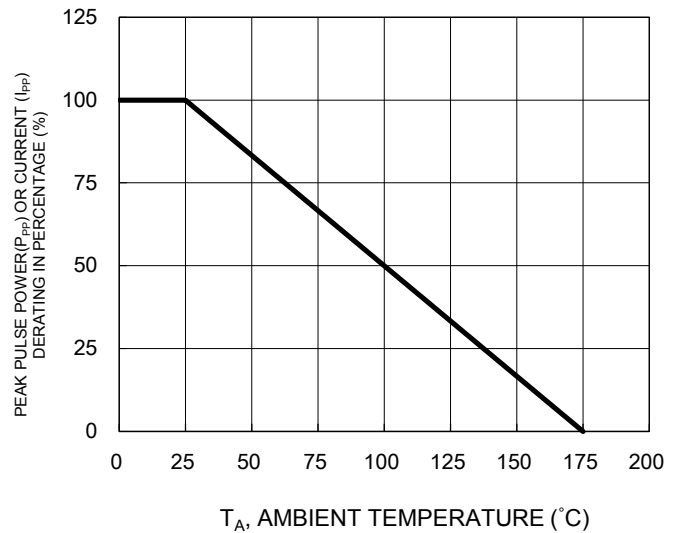
**CHARACTERISTICS CURVES**

( $T_A = 25^\circ\text{C}$  unless otherwise noted)

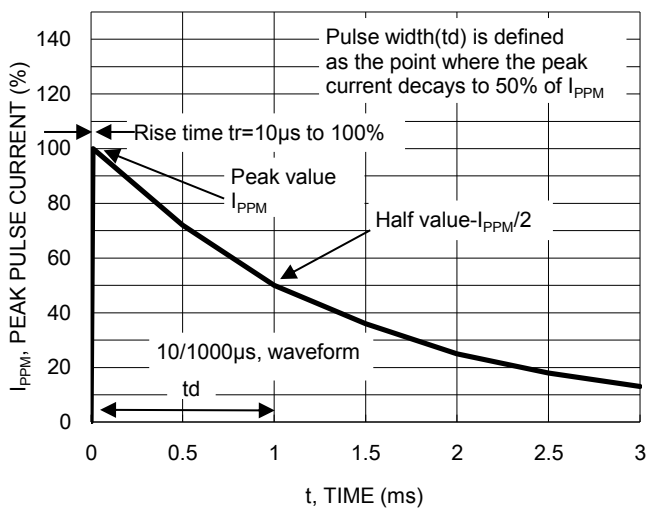
**Fig1. Peak Pulse Power Rating Curve**



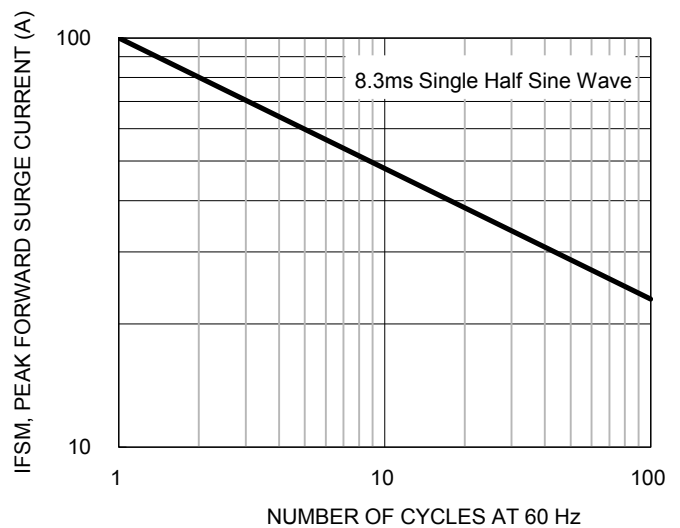
**Fig2. Pulse Derating Curve**



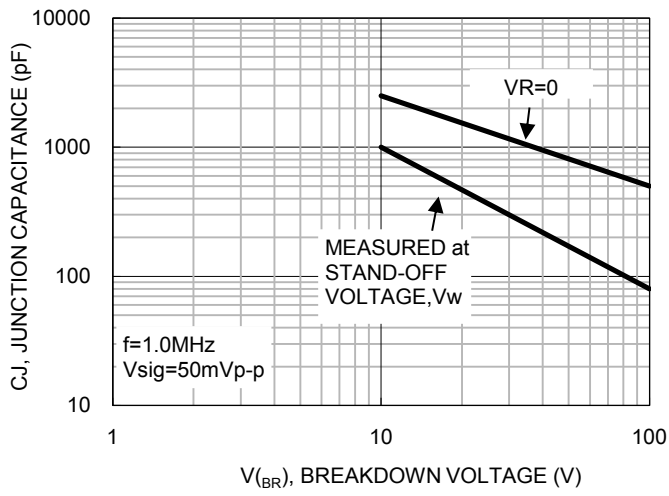
**Fig3. Clamping Power Pulse Waveform**



**Fig4. Maximum Non-Repetitive Forward Surge Current Unidirectional Only**

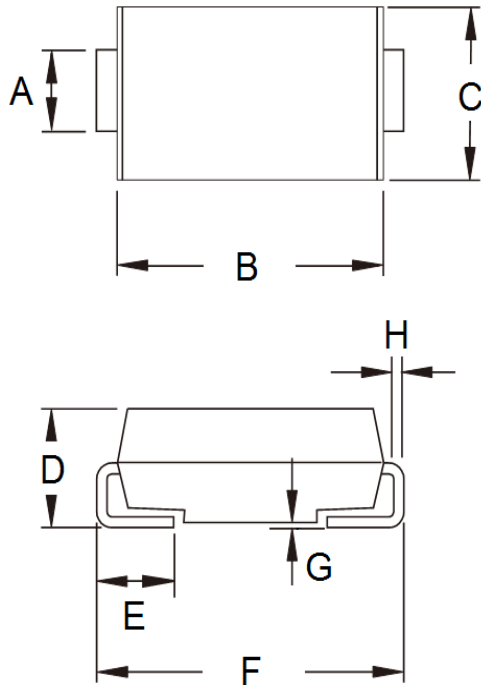


**Fig5. Typical Junction Capacitance**



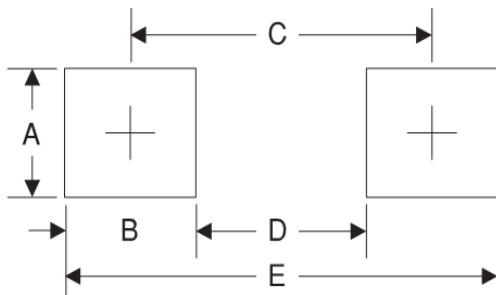
**PACKAGE OUTLINE DIMENSIONS**

DO-214AA (SMB)



DIM.	Unit (mm)		Unit (inch)	
	Min	Max	Min	Max
A	1.95	2.20	0.077	0.087
B	4.05	4.60	0.159	0.181
C	3.30	3.95	0.130	0.156
D	1.95	2.65	0.077	0.104
E	0.75	1.60	0.030	0.063
F	5.10	5.60	0.201	0.220
G	0.05	0.20	0.002	0.008
H	0.15	0.31	0.006	0.012

**SUGGESTED PAD LAYOUT**



Symbol	Unit (mm)	Unit (inch)
A	2.3	0.091
B	2.5	0.098
C	4.3	0.169
D	1.8	0.071
E	6.8	0.268

**MARKING DIAGRAM**



P/N = Marking Code  
G = Green Compound  
YW = Date Code  
F = Factory Code

## Notice

Specifications of the products displayed herein are subject to change without notice. TSC or anyone on its behalf, assumes no responsibility or liability for any errors or inaccuracies.

Information contained herein is intended to provide a product description only. No license, express or implied, to any intellectual property rights is granted by this document. Except as provided in TSC's terms and conditions of sale for such products, TSC assumes no liability whatsoever, and disclaims any express or implied warranty, relating to sale and/or use of TSC products including liability or warranties relating to fitness for a particular purpose, merchantability, or infringement of any patent, copyright, or other intellectual property right.

The products shown herein are not designed for use in medical, life-saving, or life-sustaining applications. Customers using or selling these products for use in such applications do so at their own risk and agree to fully indemnify TSC for any damages resulting from such improper use or sale.



Компания «ЭлектроПласт» предлагает заключение долгосрочных отношений при поставках импортных электронных компонентов на взаимовыгодных условиях!

Наши преимущества:

- Оперативные поставки широкого спектра электронных компонентов отечественного и импортного производства напрямую от производителей и с крупнейших мировых складов;
- Поставка более 17-ти миллионов наименований электронных компонентов;
- Поставка сложных, дефицитных, либо снятых с производства позиций;
- Оперативные сроки поставки под заказ (от 5 рабочих дней);
- Экспресс доставка в любую точку России;
- Техническая поддержка проекта, помощь в подборе аналогов, поставка прототипов;
- Система менеджмента качества сертифицирована по Международному стандарту ISO 9001;
- Лицензия ФСБ на осуществление работ с использованием сведений, составляющих государственную тайну;
- Поставка специализированных компонентов (Xilinx, Altera, Analog Devices, Intersil, Interpoint, Microsemi, Aeroflex, Peregrine, Syfer, Eurofarad, Texas Instrument, Miteq, Cobham, E2V, MA-COM, Hittite, Mini-Circuits, General Dynamics и др.);

Помимо этого, одним из направлений компании «ЭлектроПласт» является направление «Источники питания». Мы предлагаем Вам помощь Конструкторского отдела:

- Подбор оптимального решения, техническое обоснование при выборе компонента;
- Подбор аналогов;
- Консультации по применению компонента;
- Поставка образцов и прототипов;
- Техническая поддержка проекта;
- Защита от снятия компонента с производства.



#### Как с нами связаться

**Телефон:** 8 (812) 309 58 32 (многоканальный)

**Факс:** 8 (812) 320-02-42

**Электронная почта:** [org@eplast1.ru](mailto:org@eplast1.ru)

**Адрес:** 198099, г. Санкт-Петербург, ул. Калинина, дом 2, корпус 4, литера А.