

## Medium Power Silicon Rectifier Diodes, 12 A



DO-203AA (DO-4)

**FEATURES**

- Voltage ratings from 50 to 1000 V
- High surge capability
- Low thermal impedance
- High temperature rating
- Can be supplied as JAN and JAN-TX devices in accordance with MIL-S-19500/260
- RoHS compliant

**PRODUCT SUMMARY**

$I_{F(AV)}$	12 A
-------------	------

**MAJOR RATINGS AND CHARACTERISTICS**

PARAMETER	TEST CONDITIONS	VALUES	UNITS
$I_{F(AV)}$		12 <sup>(1)</sup>	A
	$T_C$	150 <sup>(1)</sup>	°C
$I_{FSM}$	50 Hz	230	A
	60 Hz	240 <sup>(1)</sup>	
$I^2t$	50 Hz	260	A <sup>2</sup> s
	60 Hz	240	
$T_C$		- 65 to 200	°C
$V_{RRM}$	Range	50 to 1000 <sup>(1)</sup>	V

**Note**

<sup>(1)</sup> JEDEC registered values

**ELECTRICAL SPECIFICATIONS**
**VOLTAGE RATINGS**

TYPE NUMBER <sup>(2)</sup>	$V_{RRM}$ , MAXIMUM REPETITIVE PEAK REVERSE VOLTAGE V	$V_{R(RMS)}$ , MAXIMUM RMS REVERSE VOLTAGE V	$V_{RSM}$ , MAXIMUM NON-REPETITIVE PEAK REVERSE VOLTAGE V	$V_{RM}$ , MAXIMUM DIRECT REVERSE VOLTAGE V
	$T_C = - 65\text{ °C TO } 200\text{ °C}$	$T_C = - 65\text{ °C TO } 200\text{ °C}$	$T_C = - 65\text{ °C TO } 200\text{ °C}$	$T_C = - 65\text{ °C TO } 200\text{ °C}$
1N1199A	50 <sup>(1)</sup>	35 <sup>(1)</sup>	100 <sup>(1)</sup>	50 <sup>(1)</sup>
1N1200A	100 <sup>(1)</sup>	70 <sup>(1)</sup>	200 <sup>(1)</sup>	100 <sup>(1)</sup>
1N1201A	150 <sup>(1)</sup>	105 <sup>(1)</sup>	300 <sup>(1)</sup>	150 <sup>(1)</sup>
1N1202A	200 <sup>(1)</sup>	140 <sup>(1)</sup>	350 <sup>(1)</sup>	200 <sup>(1)</sup>
1N1203A	300 <sup>(1)</sup>	210 <sup>(1)</sup>	450 <sup>(1)</sup>	300 <sup>(1)</sup>
1N1204A	400 <sup>(1)</sup>	280 <sup>(1)</sup>	600 <sup>(1)</sup>	400 <sup>(1)</sup>
1N1205A	500 <sup>(1)</sup>	350 <sup>(1)</sup>	700 <sup>(1)</sup>	500 <sup>(1)</sup>
1N1206A	600 <sup>(1)</sup>	420 <sup>(1)</sup>	800 <sup>(1)</sup>	600 <sup>(1)</sup>
1N3670A	700 <sup>(1)</sup>	490	900 <sup>(1)</sup>	700 <sup>(1)</sup>
1N3671A	800 <sup>(1)</sup>	560	1000 <sup>(1)</sup>	800 <sup>(1)</sup>
1N3672A	900 <sup>(1)</sup>	630	1100 <sup>(1)</sup>	900 <sup>(1)</sup>
1N3673A	1000 <sup>(1)</sup>	700	1200 <sup>(1)</sup>	1000 <sup>(1)</sup>

**Notes**

<sup>(1)</sup> JEDEC registered values

<sup>(2)</sup> Basic part number indicates cathode to case; for anode to case, add "R" to part number, e.g., 1N1199RA

# 1N1...A, 1N36..A Series



Vishay High Power Products

Medium Power  
Silicon Rectifier Diodes, 12 A

FORWARD CONDUCTION					
PARAMETER	SYMBOL	TEST CONDITIONS		VALUES	UNITS
Maximum average forward current at case temperature	$I_{F(AV)}$	180° sinusoidal conduction		12 <sup>(1)</sup>	A
				150 <sup>(1)</sup>	°C
Maximum peak one cycle non-repetitive surge current	$I_{FSM}$	Half cycle 50 Hz sine wave or 6 ms rectangular pulse	Following any rated load condition and with rated $V_{RRM}$ applied	230	A
		Half cycle 60 Hz sine wave or 5 ms rectangular pulse		240 <sup>(1)</sup>	
		Half cycle 50 Hz sine wave or 6 ms rectangular pulse	Following any rated load condition and with $V_{RRM}$ applied following surge = 0	275	
		Half cycle 60 Hz sine wave or 5 ms rectangular pulse		285	
Maximum $I^2t$ for fusing	$I^2t$	t = 10 ms	With rated $V_{RRM}$ applied following surge, initial $T_J = 200$ °C	260	A <sup>2</sup> s
		t = 8.3 ms		240	
Maximum $I^2t$ for individual device fusing	$I^2t$	t = 10 ms	With $V_{RRM} = 0$ following surge, initial $T_J = 200$ °C	370	
		t = 8.3 ms		340	
Maximum $I^2\sqrt{t}$ for individual device fusing	$I^2\sqrt{t}$ <sup>(2)</sup>	t = 0.1 to 10 ms, $V_{RRM} = 0$ following surge		3715	A <sup>2</sup> √s
Maximum forward voltage drop	$V_{FM}$	$I_{F(AV)} = 12$ A (38 A peak), $T_C = 25$ °C		1.35 <sup>(1)</sup>	V
Maximum average reverse current	$I_{R(AV)}$ <sup>(3)</sup>	Maximum rated $I_{F(AV)}$ and $T_C$		$V_{RRM} = 50$	3.0 <sup>(1)</sup>
				$V_{RRM} = 100$	2.5 <sup>(1)</sup>
				$V_{RRM} = 150$	2.25 <sup>(1)</sup>
				$V_{RRM} = 200$	2.0 <sup>(1)</sup>
				$V_{RRM} = 300$	1.75 <sup>(1)</sup>
				$V_{RRM} = 400$	1.5 <sup>(1)</sup>
				$V_{RRM} = 500$	1.25 <sup>(1)</sup>
				$V_{RRM} = 600$	1.0 <sup>(1)</sup>
				$V_{RRM} = 700$	0.9 <sup>(1)</sup>
				$V_{RRM} = 800$	0.8 <sup>(1)</sup>
				$V_{RRM} = 900$	0.7 <sup>(1)</sup>
				$V_{RRM} = 1000$	0.6 <sup>(1)</sup>

## Notes

<sup>(1)</sup> JEDEC registered values

<sup>(2)</sup>  $I^2t$  for time  $t_x = I^2\sqrt{t} \times \sqrt{t_x}$

<sup>(3)</sup> Maximum peak reverse current ( $I_{RM}$ ) under same conditions  $\approx 2 \times$  rated  $I_{R(AV)}$



<b>THERMAL AND MECHANICAL SPECIFICATIONS</b>				
PARAMETER	SYMBOL	TEST CONDITIONS	VALUES	UNITS
Maximum operating case and storage temperature range	$T_C, T_{Stg}$		- 65 to 200 <sup>(1)</sup>	°C
Maximum internal thermal resistance, junction to case	$R_{thJC}$	DC operation	2.0 <sup>(1)</sup>	°C/W
Thermal resistance, case to sink	$R_{thCS}$	Mounting surface, smooth, flat and greased	0.5	
Mounting torque	minimum	Torque applied to nut; non-lubricated threads	1.36 (12)	N · m (lbf · in)
	maximum		1.69 (15)	
	minimum	Torque applied to nut; lubricated threads	1.07 (9.45)	
	maximum		1.30 (11.55)	
	minimum	Torque applied to device case; lubricated threads	1.17 (10.35)	
	maximum		1.43 (12.65)	
Approximate weight			7.0	g
			0.25	oz.
Case style		JEDEC	DO-203AA (DO-4)	

**Note**

<sup>(1)</sup> JEDEC registered values

# 1N1...A, 1N36..A Series

Vishay High Power Products

Medium Power  
Silicon Rectifier Diodes, 12 A



Fig. 1 - Average Forward Current vs. Maximum Allowable Case Temperature



Fig. 4 - Maximum Forward Voltage vs. Forward Current



Fig. 2 - Maximum Low Level Forward Power Loss vs. Average Forward Current



Fig. 5 - Maximum Transient Thermal Impedance, Junction to Case vs. Pulse Duration



Fig. 3 - Maximum High Level Forward Power Loss vs. Average Forward Current

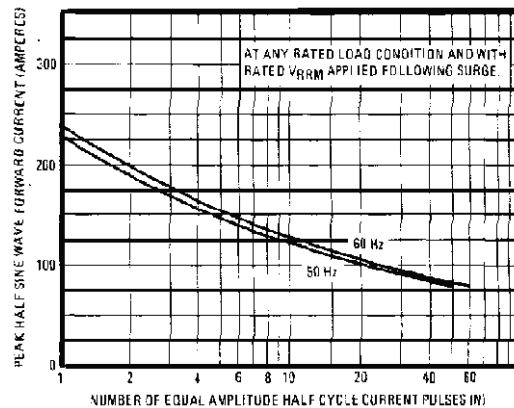

Fig. 6 - Maximum Non-Repetitive 50 Hz Surge Current vs. Number of Current Pulses

## LINKS TO RELATED DOCUMENTS

Dimensions

<http://www.vishay.com/doc?95311>

## DO-203AA (DO-4)

**DIMENSIONS** in millimeters (inches)





## Disclaimer

ALL PRODUCT, PRODUCT SPECIFICATIONS AND DATA ARE SUBJECT TO CHANGE WITHOUT NOTICE TO IMPROVE RELIABILITY, FUNCTION OR DESIGN OR OTHERWISE.

Vishay Intertechnology, Inc., its affiliates, agents, and employees, and all persons acting on its or their behalf (collectively, "Vishay"), disclaim any and all liability for any errors, inaccuracies or incompleteness contained in any datasheet or in any other disclosure relating to any product.

Vishay makes no warranty, representation or guarantee regarding the suitability of the products for any particular purpose or the continuing production of any product. To the maximum extent permitted by applicable law, Vishay disclaims (i) any and all liability arising out of the application or use of any product, (ii) any and all liability, including without limitation special, consequential or incidental damages, and (iii) any and all implied warranties, including warranties of fitness for particular purpose, non-infringement and merchantability.

Statements regarding the suitability of products for certain types of applications are based on Vishay's knowledge of typical requirements that are often placed on Vishay products in generic applications. Such statements are not binding statements about the suitability of products for a particular application. It is the customer's responsibility to validate that a particular product with the properties described in the product specification is suitable for use in a particular application. Parameters provided in datasheets and/or specifications may vary in different applications and performance may vary over time. All operating parameters, including typical parameters, must be validated for each customer application by the customer's technical experts. Product specifications do not expand or otherwise modify Vishay's terms and conditions of purchase, including but not limited to the warranty expressed therein.

Except as expressly indicated in writing, Vishay products are not designed for use in medical, life-saving, or life-sustaining applications or for any other application in which the failure of the Vishay product could result in personal injury or death. Customers using or selling Vishay products not expressly indicated for use in such applications do so at their own risk and agree to fully indemnify and hold Vishay and its distributors harmless from and against any and all claims, liabilities, expenses and damages arising or resulting in connection with such use or sale, including attorneys fees, even if such claim alleges that Vishay or its distributor was negligent regarding the design or manufacture of the part. Please contact authorized Vishay personnel to obtain written terms and conditions regarding products designed for such applications.

No license, express or implied, by estoppel or otherwise, to any intellectual property rights is granted by this document or by any conduct of Vishay. Product names and markings noted herein may be trademarks of their respective owners.

## Material Category Policy

**Vishay Intertechnology, Inc. hereby certifies that all its products that are identified as RoHS-Compliant fulfill the definitions and restrictions defined under Directive 2011/65/EU of The European Parliament and of the Council of June 8, 2011 on the restriction of the use of certain hazardous substances in electrical and electronic equipment (EEE) - recast, unless otherwise specified as non-compliant.**

**Please note that some Vishay documentation may still make reference to RoHS Directive 2002/95/EC. We confirm that all the products identified as being compliant to Directive 2002/95/EC conform to Directive 2011/65/EU.**



Компания «ЭлектроПласт» предлагает заключение долгосрочных отношений при поставках импортных электронных компонентов на взаимовыгодных условиях!

Наши преимущества:

- Оперативные поставки широкого спектра электронных компонентов отечественного и импортного производства напрямую от производителей и с крупнейших мировых складов;
- Поставка более 17-ти миллионов наименований электронных компонентов;
- Поставка сложных, дефицитных, либо снятых с производства позиций;
- Оперативные сроки поставки под заказ (от 5 рабочих дней);
- Экспресс доставка в любую точку России;
- Техническая поддержка проекта, помощь в подборе аналогов, поставка прототипов;
- Система менеджмента качества сертифицирована по Международному стандарту ISO 9001;
- Лицензия ФСБ на осуществление работ с использованием сведений, составляющих государственную тайну;
- Поставка специализированных компонентов (Xilinx, Altera, Analog Devices, Intersil, Interpoint, Microsemi, Aeroflex, Peregrine, Syfer, Eurofarad, Texas Instrument, Miteq, Cobham, E2V, MA-COM, Hittite, Mini-Circuits, General Dynamics и др.);

Помимо этого, одним из направлений компании «ЭлектроПласт» является направление «Источники питания». Мы предлагаем Вам помощь Конструкторского отдела:

- Подбор оптимального решения, техническое обоснование при выборе компонента;
- Подбор аналогов;
- Консультации по применению компонента;
- Поставка образцов и прототипов;
- Техническая поддержка проекта;
- Защита от снятия компонента с производства.



#### Как с нами связаться

**Телефон:** 8 (812) 309 58 32 (многоканальный)

**Факс:** 8 (812) 320-02-42

**Электронная почта:** [org@eplast1.ru](mailto:org@eplast1.ru)

**Адрес:** 198099, г. Санкт-Петербург, ул. Калинина, дом 2, корпус 4, литера А.