

PRODUCT NUMBER
SEE SHEET 16

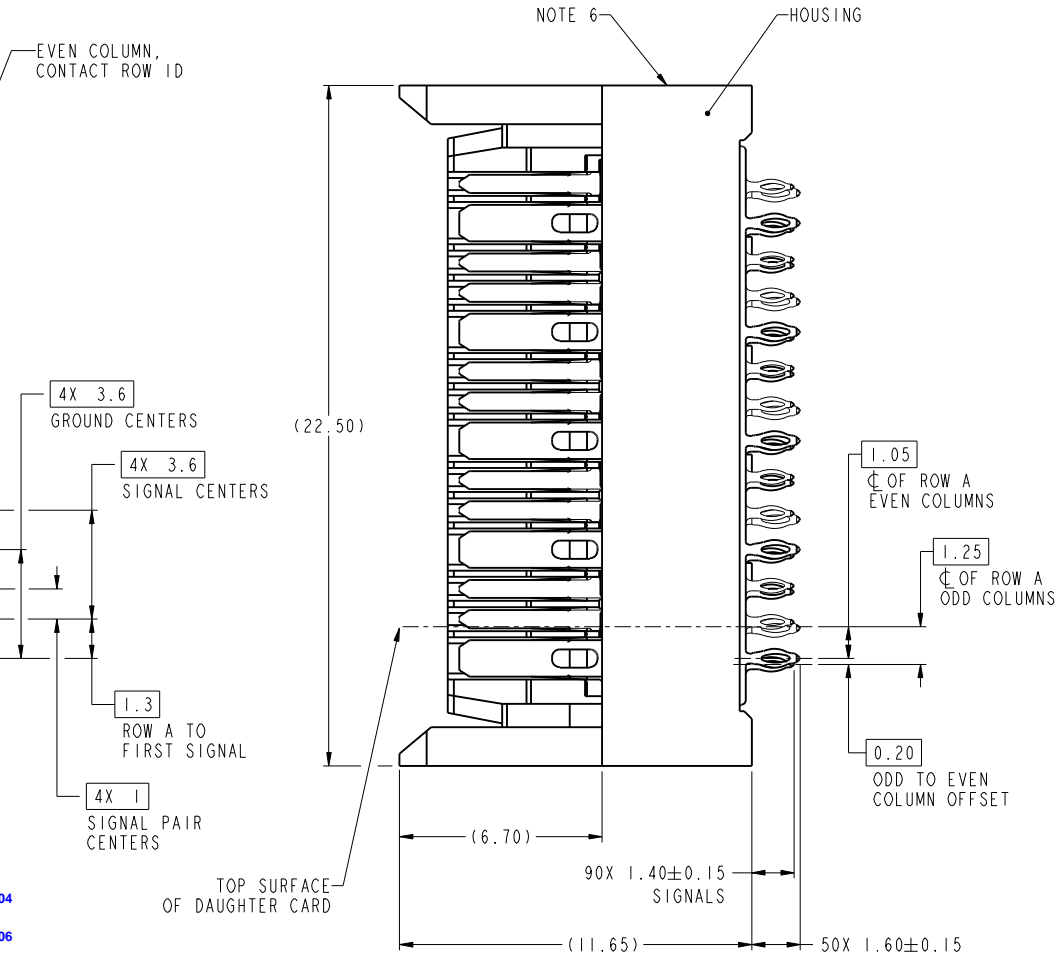
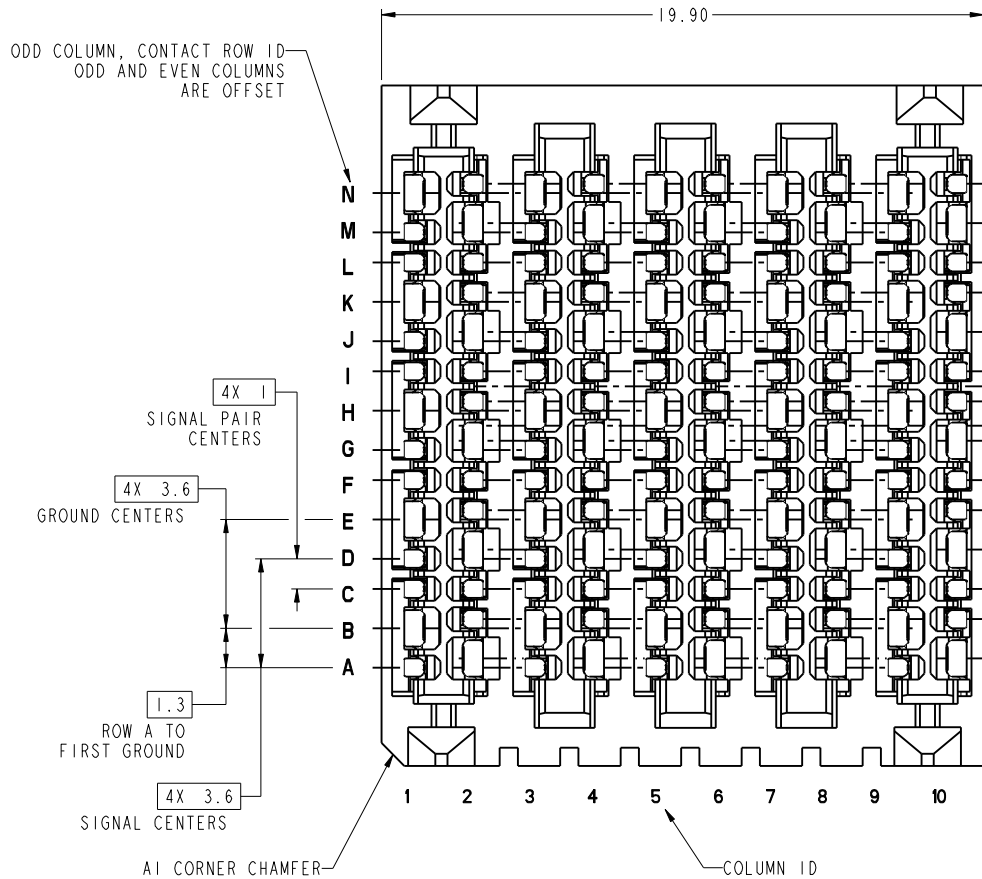

10135223-Y01LF
(10135223-101LF STANDARD MATE CON.)

Greg Hull 2015/06/04
Peng-Bing Fu 2016/04/06

SEE NOTE 6
Preliminary

spec ref	SEE NOTES	dr	G. HULL	2015-07-09	projection	MM	size	A2
tolerance std	TOLERANCES UNLESS OTHERWISE SPECIFIED	eng	G. HULL	2015-07-09			ech no	2
ISO 406		chr	G. HULL	2015-07-09			rel level	
ISO 1101		appr			product family	ExaMAX	rel level	
surface	linear	Amphenol FCI		ExaMAX VERTICAL HEADER ASSY		ang no	10135223	rev
	0.X ±.3			4 PR, 85 Ohm, 140 POS, 10 IMLA				2
	0.XX ±.10			SEE TABLE		Product - Customer	Draw	sheet 1 of 11
	0.XXX ±.050							
ISO 1302	angular	0°	±°					

For information only. This is a preliminary customer document that is subject to change without notice.

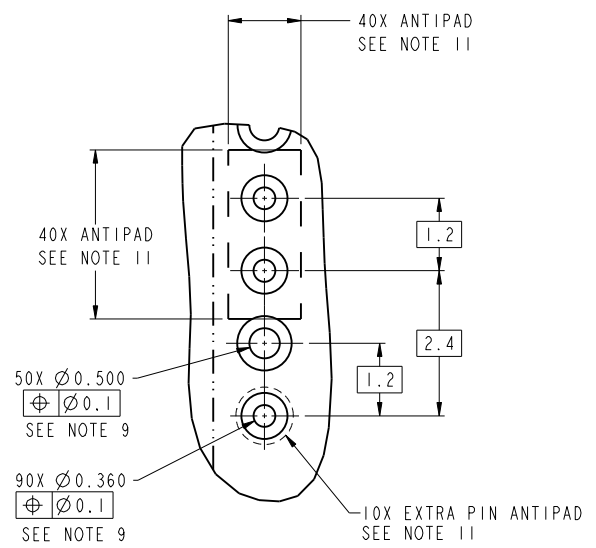
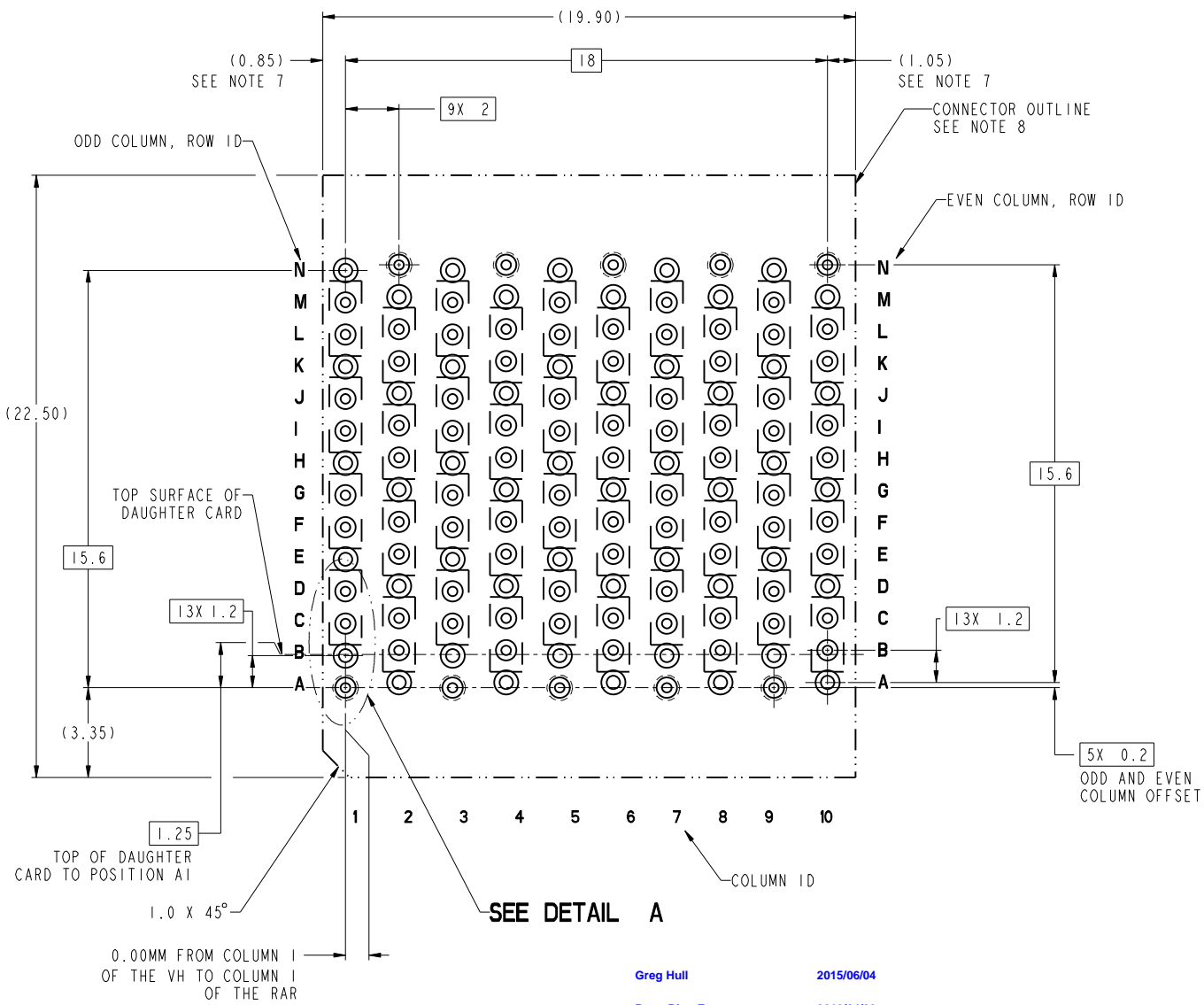

DETAIL A
SCALE 16:1

Greg Hull 2015/06/04
Peng-Bing Fu 2016/04/06

RECOMMENDED PC-10135223-Y01LF COMPONENT SIDE
SEE NOTES 7, 9, 9, & 11

Preliminary

spec ref	SEE NOTES	dr	G. HULL	2015-07-09	projection	MM	size	A2
tolerance std	TOLERANCES UNLESS OTHERWISE SPECIFIED	eng	G. HULL	2015-07-09			ech no	2
ISO 406		chr	G. HULL	2015-07-09			rel level	
ISO 1101		appr			product family	ExaMAX		
surface	linear	0.X	±.3		ExaMAX VERTICAL HEADER ASSY 4 PR, 85 Ohm, 140 POS, 10 IMLA SEE TABLE	ang no 10135223	rev 2	sheet 2 of 11
		0.XX	±.10					
		0.XXX	±.050					
ISO 1302	angular	0°	±°	col. no.	Product - Customer Drw			

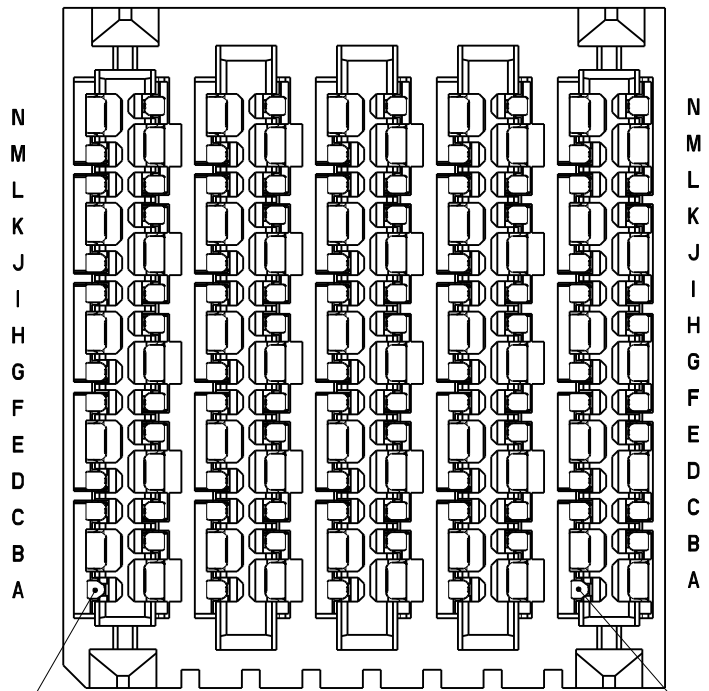

ADVANCED MATE POSITION A1
SEE NOTE 13

ADVANCED MATE POSITION A9
SEE NOTE 13

10135223-201LF
ADVANCED MATE CONNECTOR
ADVANCED MATE POSITIONS ARE POSITIONS A1 AND A9 ONLY
HEETS 1 & 2

F Greg Hull 2015/06/04
 Peng-Bing Fu 2016/04/06

Preliminary

spec ref	SEE NOTES	dr	G. HULL	2015-07-09	projection	MM	size	A2	
tolerance std	TOLERANCES UNLESS OTHERWISE SPECIFIED	eng	G. HULL	2015-07-09			ech no	2	
ISO 406		chr	G. HULL	2015-07-09			rel level		
ISO 1101		appr			product family	ExaMAX			
surface	linear	0.X	±.3		ExaMAX VERTICAL HEADER ASSY 4 PR, 85 Ohm, 140 POS, 10 IMLA			ang no	10135223
		0.XX	±.10		cat. no.	SEE TABLE	Product - Customer Drw	sheet 3 of 11	
ISO 1302	angular	0°	±°					rev	2

For information only. This is a preliminary customer document that is subject to change without notice.

1 2 3 4 5 6 7 8

A
B
C
D
E
F

A
B
C
D
E
F

SHORT DETECT
POSITION N2
SEE NOTE 14

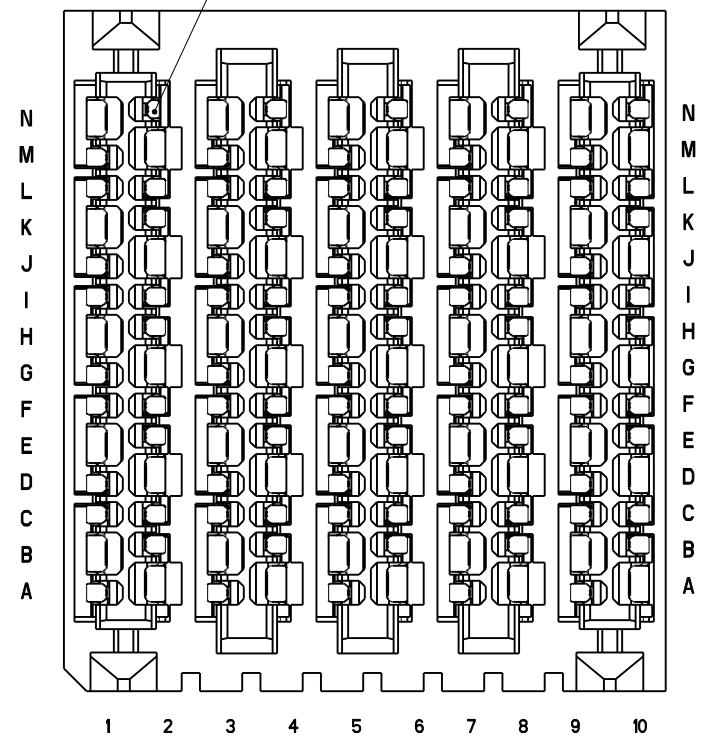

10135223-301LF
SHORT DETECT CONNECTOR
SHORT DETECT POSITION IS N2 ONLY

F Greg Hull 2015/06/04 SHEETS 1 & 2
Peng-Bing Fu 2016/04/06

Preliminary

spec ref	SEE NOTES	dr	G. HULL	2015-07-09	projection	MM	size	A2
tolerance std	TOLERANCES UNLESS OTHERWISE SPECIFIED	eng	G. HULL	2015-07-09			ech no	2
ISO 406		chr	G. HULL	2015-07-09			rel level	
ISO 1101		appr			product family	ExaMAX		
surface	linear	Amphenol FCI	Title		ExaMAX VERTICAL HEADER ASSY		ang no	10135223
	0.X ±.3	4 PR, 85 Ohm, 140 POS, 10 IMLA		cat. no.	SEE TABLE	Product - Customer Drw	sheet 4 of 11	
	0.XX ±.10							
	0.XXX ±.050							
ISO 1302	angular							
	0° ±°							

For information only. This is a preliminary customer document that is subject to change without notice.

1 2 3 4 5 6 7 8

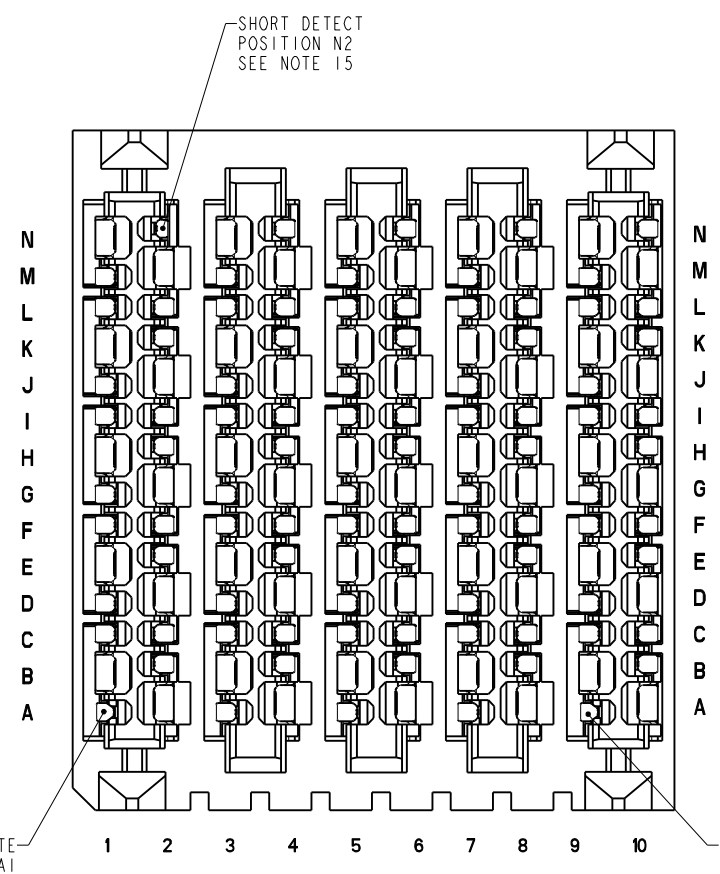

10135223-401LF
ADVANCED MATE/SHORT DETECT CONNECTOR
ADVANCED MATE POSITIONS ARE POSITIONS A1 AND A9 ONLY
2 ONLY
SHEETS 1 & 2

Greg Hull 2015/06/04
 Peng-Bing Fu 2016/04/06

Preliminary

spec ref	SEE NOTES	dr	G. HULL	2015-07-09	projection	MM	size	A2
tolerance std	TOLERANCES UNLESS OTHERWISE SPECIFIED	eng	G. HULL	2015-07-09			ech no	2
ISO 406		chr	G. HULL	2015-07-09			rel level	
ISO 1101		appr			product family	ExaMAX		
surface	linear	0.X	±.3		ExaMAX VERTICAL HEADER ASSY		ang no 10135223	rev 2
		0.XX	±.10		4 PR, 85 Ohm, 140 POS, 10 IMLA			
ISO 1302	angular	0°	±°	cat. no.	SEE TABLE	Product - Customer Drw	sheet 5 of 11	

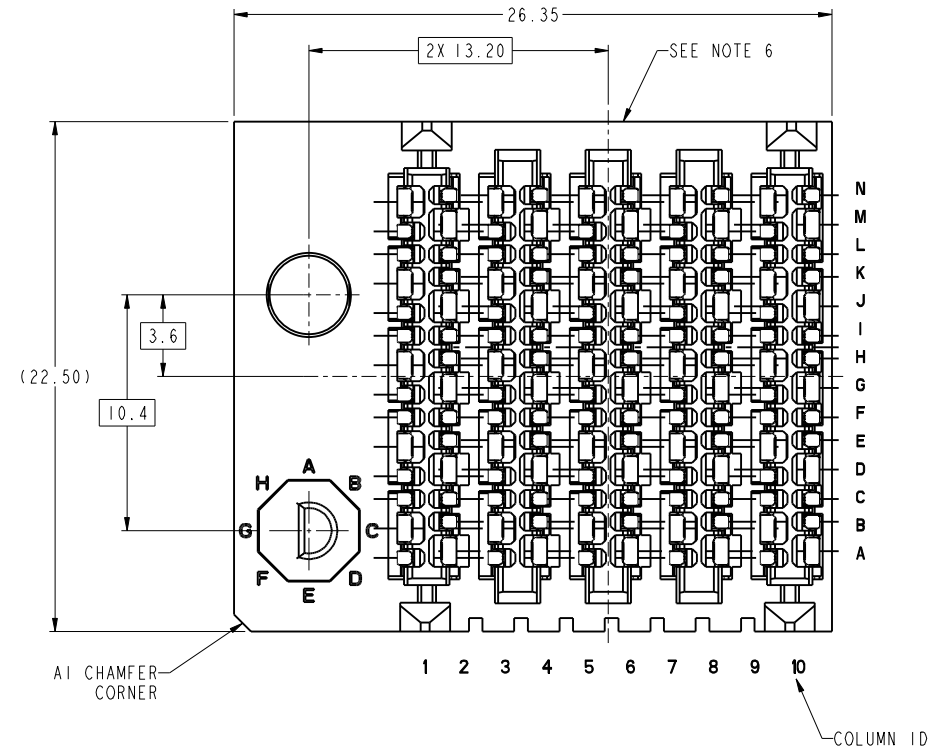
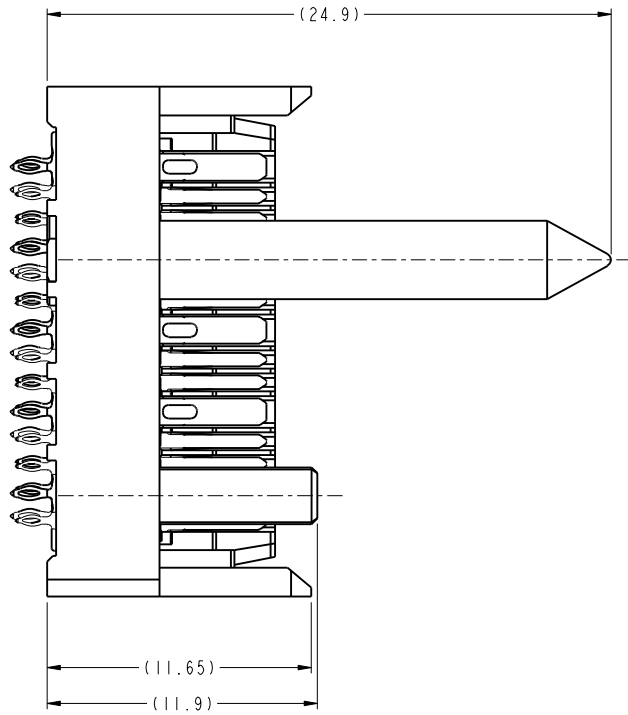

10135223-VIAI E TUDII-VIIE
 RIC... GREG HULL 2015/06/04 (NOTE 17)
 FI Peng-Bing Fu 2016/04/06 SHEET 1

Preliminary

spec ref	SEE NOTES	dr	G. HULL	2015-07-09	projection	MM	size	A2	
tolerance std	TOLERANCES UNLESS OTHERWISE SPECIFIED	eng	G. HULL	2015-07-09			ech no	2	
ISO 406		chr	G. HULL	2015-07-09			rel level		
ISO 1101		appr			product family	ExaMAX			
surface	linear	0.X	±.3		ExaMAX VERTICAL HEADER ASSY			ang no	10135223
		0.XX	±.10		4 PR, 85 Ohm, 140 POS, 10 IMLA			rev	2
		0.XXX	±.050		SEE TABLE			col. no.	
ISO 1302	angular	0°	±°		Product - Customer	Product - Customer	Product - Customer	Product - Customer	

For information only. This is a preliminary customer document that is subject to change without notice.

Amphenol FCI

© 2016 Amphenol FCI

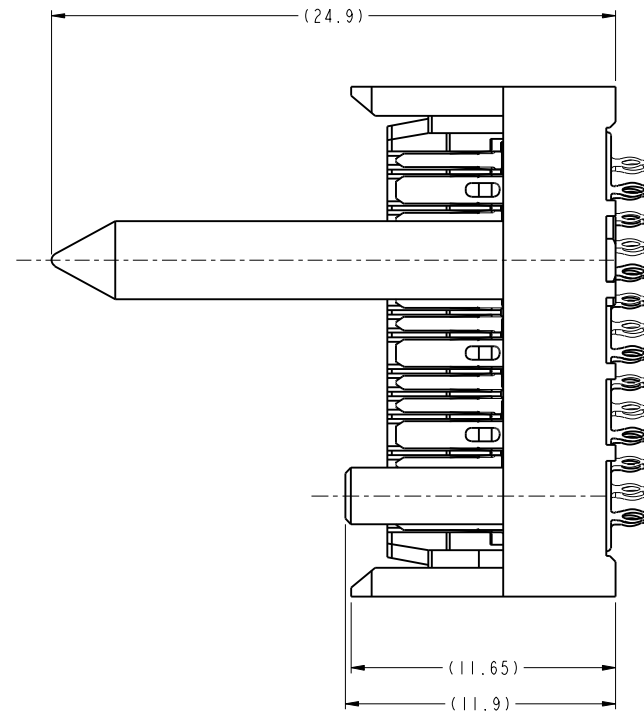
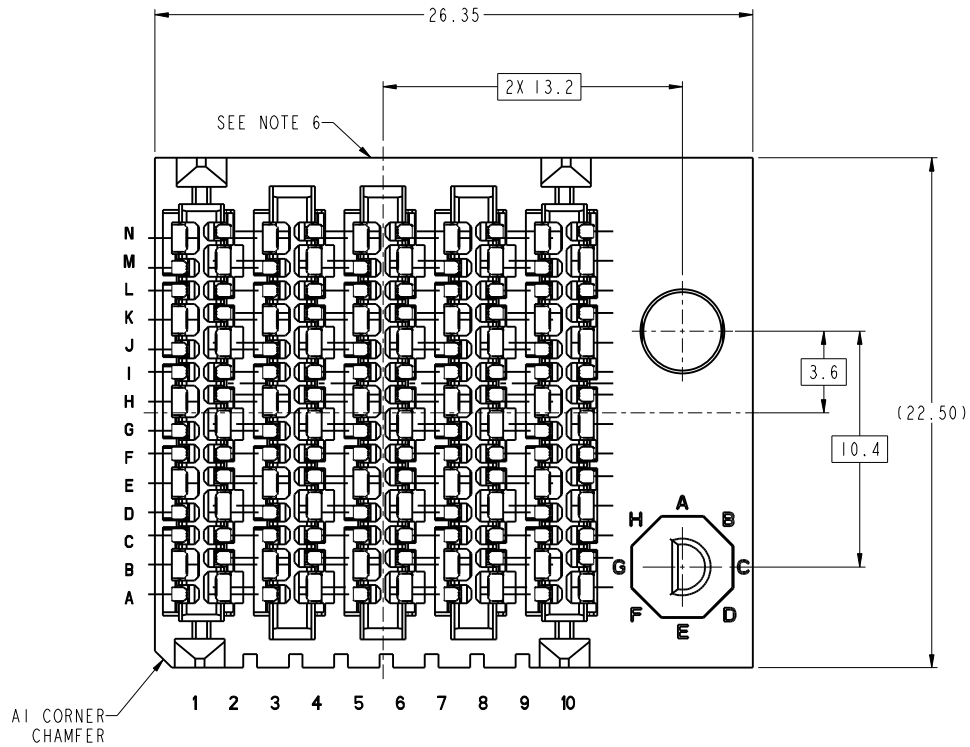

Greg Hull 2015/06/04

Peng-Bing Fu 2016/04/06

10135223 12JLF
E NOTE 17)
E SHEET 1

Preliminary

spec ref	SEE NOTES	dr	G. HULL	2015-07-09	projection	MM	size	A2
tolerance std	TOLERANCES UNLESS OTHERWISE SPECIFIED	eng	G. HULL	2015-07-09			ech no	2
ISO 406		chr	G. HULL	2015-07-09			rel level	
ISO 1101		appr			product family	ExaMAX	rel level	
surface	linear	0.X	±.3		ExaMAX VERTICAL HEADER ASSY		ang no	10135223
		0.XX	±.10		4 PR, 85 Ohm, 140 POS, 10 IMLA		rev	2
	angular	0°	±°		cat. no.	SEE TABLE	Product - Customer Drw	sheet 8 of 11

For information only. This is a preliminary customer document that is subject to change without notice.

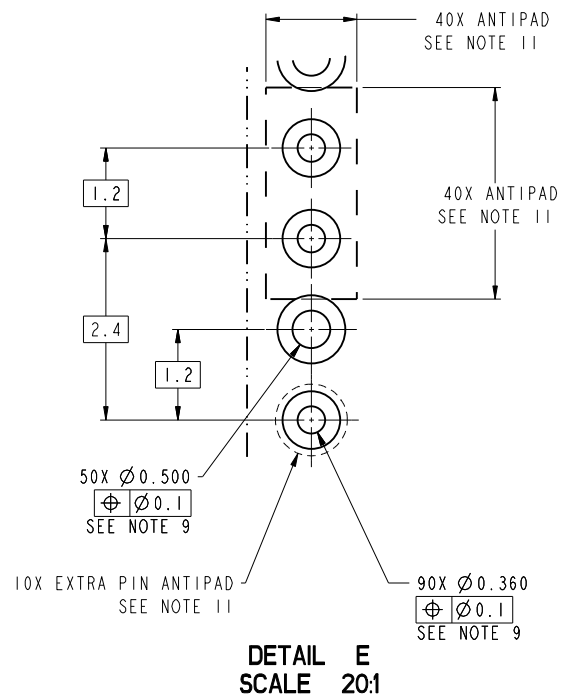
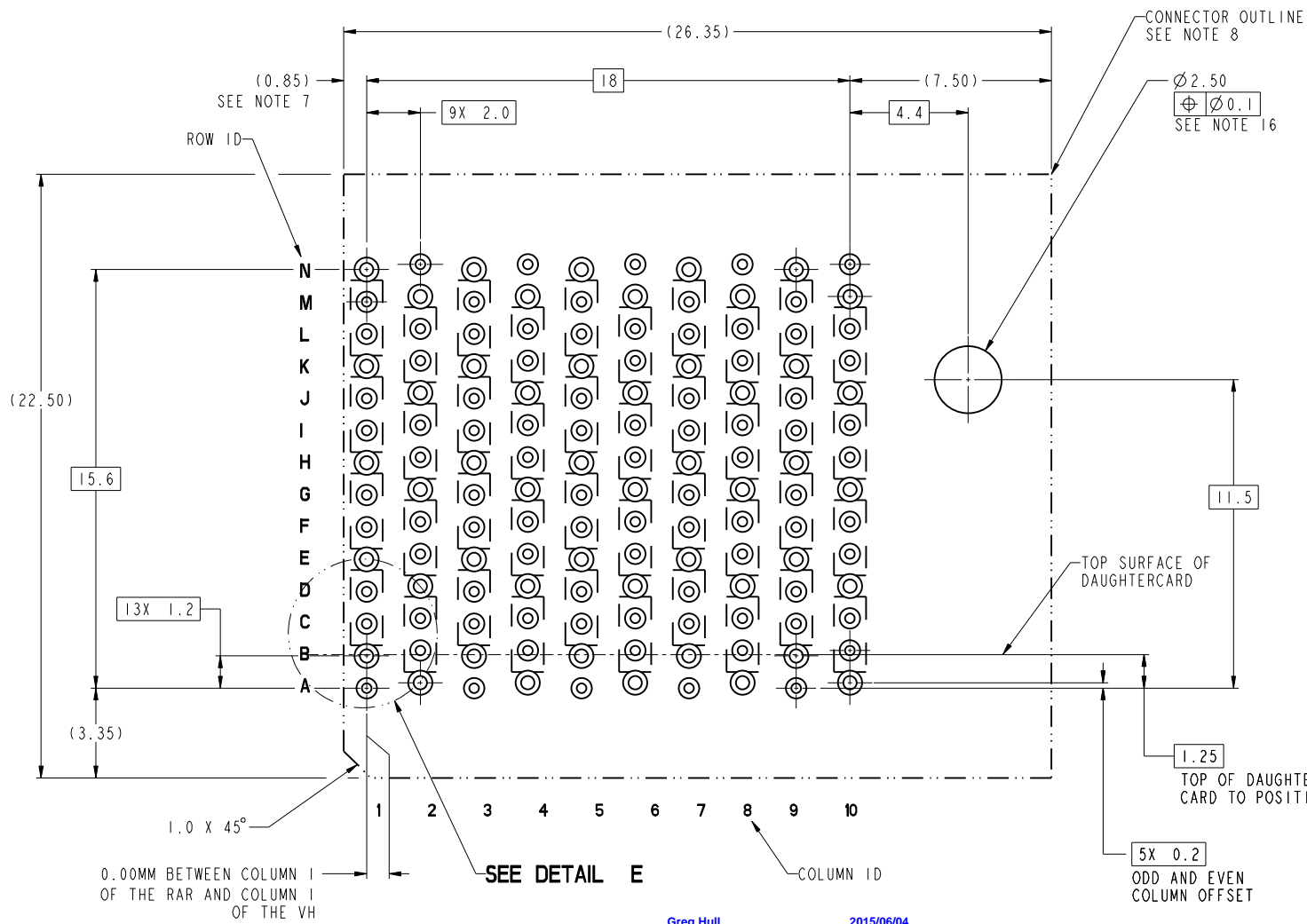

0.00MM BETWEEN COLUMN 1 OF THE RAR AND COLUMN 1 OF THE VH

SEE DETAIL E

COLUMN ID

5X 0.2 ODD AND EVEN COLUMN OFFSET











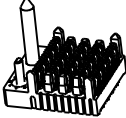







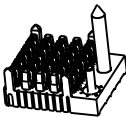

Greg Hull 2015/06/04
Peng-Bing Fu 2016/04/06

RECOMMENDED
1013522-1
COMPONENT SIDE
SEE NOTES 7, 8, 9, 11 & 16

Preliminary

spec ref	SEE NOTES	dr	G. HULL	2015-07-09	projection	MM	size	A2
tolerance std	TOLERANCES UNLESS OTHERWISE SPECIFIED	eng	G. HULL	2015-07-09			ech no	2
ISO 406		chr	G. HULL	2015-07-09			rel level	
ISO 1101		appr			product family	ExaMAX		
surface	linear	linear	0.x ± 0.3	0.xx ± 0.10	0.xxx ± 0.050	angular	0° ± 0°	
ISO 1302		Amphenol FCI	ExaMAX VERTICAL HEADER ASSY		ang no	10135223	rev	2
		col. no.	4 PR, 85 Ohm, 140 POS, 10 IMLA	SEE TABLE	Product - Customer Drw	sheet 9 of 11		

10135223 - Y Y Y L F



MODULE DESCRIPTION	DESIGNATION REPRESENTED IN DASH NUMBER									BASE MODULE
STANDARD NO GUIDANCE (SEE SHEET 1)	01									
RIGHT GUIDANCE MODULE (SEE SHEET 6)	1A	1B	1C	1D	1E	1F	1G	1H	1J (NO KEY)	
										
LEFT GUIDANCE MODULE (SEE SHEET 8)	2A	2B	2C	2D	2E	2F	2G	2H	2J (NO KEY)	
										

ASSEMBLY PART NUMBER	DESCRIPTION
10135223-1YYLF	STANDARD MATE
10135223-2YYLF	ADVANCED MATE
10135223-3YYLF	SHORT DETECT
10135223-4YYLF	ADVANCED MATE & SHORT DETECT

Greg Hull 2015/06/04

Peng-Bing Fu 2016/04/06

Preliminary

spec ref	SEE NOTES	dr	G. HULL	2015-07-09	projection	MM	size	A2					
tolerance std	TOLERANCES UNLESS OTHERWISE SPECIFIED	eng	G. HULL	2015-07-09			ech no	2					
ISO 406		chr	G. HULL	2015-07-09									
ISO 1101		appr											
surface	linear	0.X	±.3		product family	ExaMAX	rel level	rev					
ISO 1302	angular	0.XX	±.10						title	ExaMAX VERTICAL HEADER ASSY	ang no	10135223	2
		0.XXX	±.050										
		0°	±°	cat. no.	SEE TABLE	Product - Customer Drw	sheet 10 of 11						

For information only. This is a preliminary customer document that is subject to change without notice.

Amphenol FCI

© 2016 APCI

NOTES

- ① - CONNECTOR MATERIALS:
HOUSING: HIGH TEMP THERMOPLASTIC, BLACK, UL94-V0
IMLA PLASTIC: HIGH TEMP THERMOPLASTIC, NATURAL, UL94-V0
CONTACT: COPPER ALLOY
GUIDE PIN: ZINC ALLOY
POLARIZING PIN: ZINC ALLOY
- 2 - CONTACT PLATING:
SEPARABLE INTERFACE:
PERFORMANCE-BASED PLATING, QUALIFIED TO MEET THE REQUIREMENTS OF FCI PRODUCT SPECIFICATION GS-12-1096 INCLUDING TELCORDIA GR-1217-CORE (NOVEMBER 1995) CENTRAL OFFICE TEST SEQUENCE

PRESS-FIT TAILS: TIN OVER NICKEL (LEAD FREE)
- 3 - PRODUCT SPECIFICATION: GS-12-1096
- 4 - APPLICATION SPECIFICATION: GS-20-0361
- 5 - PACKAGING MEETS GS-14-920 LEAD FREE LABELING SPECIFICATION.
- ⑥ - PRODUCT MARKING, (PART NUMBER & LOT CODE), ON THIS SURFACE.
- ⑦ - THE MINIMUM VIA SPACING BETWEEN STACKED CONNECTORS WILL BE 2.0 mm OR 3.0 mm AS DEFINED BY NOTE 7 ON THE MATING RECEPTACLE CUSTOMER DRAWING. REFER TO THE APPLICATION SPECIFICATION FOR DETAILS.
- ⑧ - CONNECTOR OUTLINE MAY BE SCREEN PRINTED ONTO CUSTOMER PCB TO BE USED AS A GUIDE FOR MANUAL CONNECTOR PLACEMENT.
- ⑨ - REFER TO CUSTOMER DRAWING 10119933 FOR INFORMATION ON PCB HOLE DIAMETERS AND PLATING OPTIONS
- 10 - THIS PRODUCT MEETS THE EUROPEAN UNION DIRECTIVES & OTHER COUNTRY REGULATIONS AS DESCRIBED IN GS-47-0004
- ⑪ - REFER TO THE APPLICATION SPECIFICATION FOR TRACE ROUTING EXAMPLES THAT INCLUDE DIMENSIONS FOR ANTIPADS, TRACE WIDTHS, TRACE SPACING, ETC.
- 12 - THE HOUSING WILL WITHSTAND EXPOSURE TO 260°C FOR 10-30 SECONDS IN A CONVECTION, INFRA-RED, OR VAPOR PHASE REFLOW OVEN.
- ⑬ - THE ADVANCED MATE HEADER, 10135223-2YYLF, WHEN MATED WITH AN ADVANCED MATE RECEPTACLE WILL PROVIDE 2 PAIRS OF MATING CONTACTS THAT MATE 0.75MM BEFORE THE REMAINDER OF THE SIGNAL AND GROUND CONTACTS.
- ⑭ - THE SHORT DETECT HEADER, 10135223-3YYLF, WHEN MATED WITH A STANDARD MATE RECEPTACLE WILL PROVIDE 1 PAIR OF MATING CONTACTS THAT MATE 1.00 MM AFTER THE REMAINDER OF THE SIGNAL AND GROUND CONTACTS.
- ⑮ - THE ADVANCED MATE/SHORT DETECT HEADER, 10135223-4YYLF, WHEN MATED WITH AN ADVANCED MATE RECEPTACLE WILL PROVIDE 2 PAIRS OF MATING CONTACTS THAT MATE 0.75 MM BEFORE THE REMAINDER OF THE SIGNAL AND GROUND CONTACTS AND 1 PAIR OF MATING CONTACTS THAT MATE 1.00 MM AFTER THE REMAINDER OF THE SIGNAL AND GROUND CONTACTS.
- ⑯ - FOR CONNECTORS WITH EITHER A RIGHT OR LEFT GUIDE MODULE, ONE PHILLIPS SCREW MUST BE USED TO SECURE GUIDE PIN/CONNECTOR TO THE PCB. THE SCREW IS 2.0 - 6.0mm PLUS THE THICKNESS OF THE BOARD. SCREW IS NOT PROVIDED WITH CONNECTOR.
- ⑰ - LEFT / RIGHT INTEGRATED GUIDE ORIENTATION IS DETERMINED BY THE LOCATION OF THE GUIDE FEATURES WHEN LOOKING AT THE MATING FACE OF THE RIGHT ANGLE RECEPTACLE. THE LEFT / RIGHT DESIGNATION OF THE MATING HEADER IS DEFINED BY THE RIGHT ANGLE RECEPTACLE THAT IT MATES WITH (i.e. A RIGHT GUIDE VERTICAL HEADER MATES WITH A RIGHT GUIDE RIGHT ANGLE RECEPTACLE).
- ⑱ - ALL GROUND CONTACTS WITHIN A COLUMN ARE COMMONED.

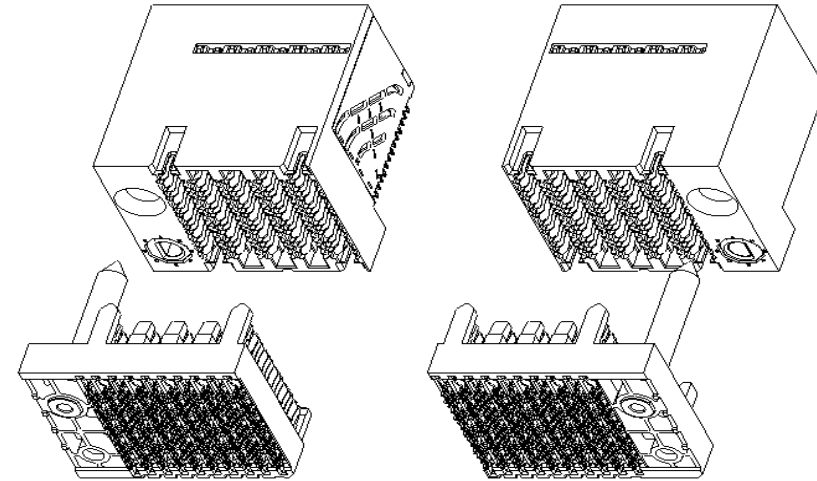

LEFT GUIDE

RIGHT GUIDE

ExaMAX INTEGRATED GUIDE ORIENTATION
SEE NOTE 17

Greg Hull 2015/06/04

Peng-Bing Fu 2016/04/06

Preliminary

spec ref	SEE NOTES	dr	G. HULL	2015-07-09	projection	MM	size	A2
tolerance std	TOLERANCES UNLESS OTHERWISE SPECIFIED	eng	G. HULL	2015-07-09			ech no	2
ISO 406		chr	G. HULL	2015-07-09			rel level	
ISO 1101		appr			product family	ExaMAX		
surface	linear	0.X	±.3		ExaMAX VERTICAL HEADER ASSY		ang no	10135223
		0.XX	±.10		4 PR, 85 Ohm, 140 POS, 10 IMLA		rev	2
		0.XXX	±.050		SEE TABLE		Product - Customer Drw	sheet 11 of 11
ISO 1302	angular	0°	±°	cat. no.				



Компания «ЭлектроПласт» предлагает заключение долгосрочных отношений при поставках импортных электронных компонентов на взаимовыгодных условиях!

Наши преимущества:

- Оперативные поставки широкого спектра электронных компонентов отечественного и импортного производства напрямую от производителей и с крупнейших мировых складов;
- Поставка более 17-ти миллионов наименований электронных компонентов;
- Поставка сложных, дефицитных, либо снятых с производства позиций;
- Оперативные сроки поставки под заказ (от 5 рабочих дней);
- Экспресс доставка в любую точку России;
- Техническая поддержка проекта, помощь в подборе аналогов, поставка прототипов;
- Система менеджмента качества сертифицирована по Международному стандарту ISO 9001;
- Лицензия ФСБ на осуществление работ с использованием сведений, составляющих государственную тайну;
- Поставка специализированных компонентов (Xilinx, Altera, Analog Devices, Intersil, Interpoint, Microsemi, Aeroflex, Peregrine, Syfer, Eurofarad, Texas Instrument, Miteq, Cobham, E2V, MA-COM, Hittite, Mini-Circuits, General Dynamics и др.);

Помимо этого, одним из направлений компании «ЭлектроПласт» является направление «Источники питания». Мы предлагаем Вам помощь Конструкторского отдела:

- Подбор оптимального решения, техническое обоснование при выборе компонента;
- Подбор аналогов;
- Консультации по применению компонента;
- Поставка образцов и прототипов;
- Техническая поддержка проекта;
- Защита от снятия компонента с производства.



Как с нами связаться

Телефон: 8 (812) 309 58 32 (многоканальный)

Факс: 8 (812) 320-02-42

Электронная почта: org@eplast1.ru

Адрес: 198099, г. Санкт-Петербург, ул. Калинина, дом 2, корпус 4, литера А.