

# EMI7403

## EMI Filter with ESD Protection for MicroSD Card Applications

### Product Description

The EMI7403 is a combination EMI filter with integrated TVS diodes for use on Multimedia Card interfaces. This state-of-the-art device utilizes solid-state, silicon-avalanche technology for superior clamping performance and DC electrical characteristics. The EMI7403 has been optimized for protection of MicroSD interfaces in smart phones and other portable electronics.

### Features

- Provides ESD Protection to IEC61000-4-2: ±15 kV Contact Discharge
- Protection and Termination for 6 Lines + V<sub>CC</sub>
- These Devices are Pb-Free, Halogen Free/BFR Free and are RoHS Compliant

### Applications

- MicroSD Interfaces
- MMC Interfaces
- Feature Phones, Smart Phones

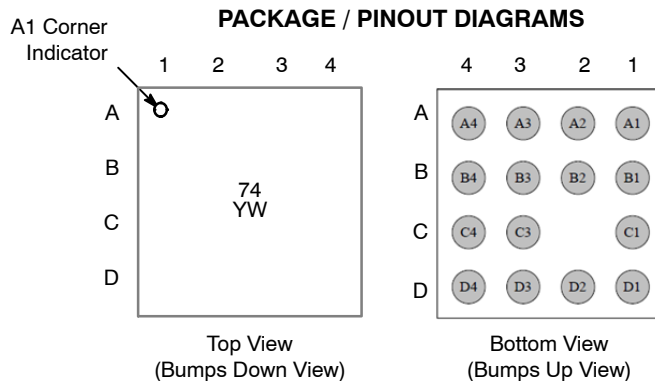

**ON Semiconductor®**

<http://onsemi.com>

### MARKING DIAGRAM



**WLCSP15  
CASE 567FX**

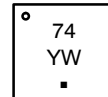

- 74 = Specific Device Code
- Y = Year
- W = Work Week
- = Pb-Free Package

### ORDERING INFORMATION

| Device       | Package           | Shipping†          |
|--------------|-------------------|--------------------|
| EMI7403FCTBG | WLCSP15 (Pb-Free) | 5000 / Tape & Reel |

†For information on tape and reel specifications, including part orientation and tape sizes, please refer to our Tape and Reel Packaging Specifications Brochure, BRD8011/D.

# EMI7403

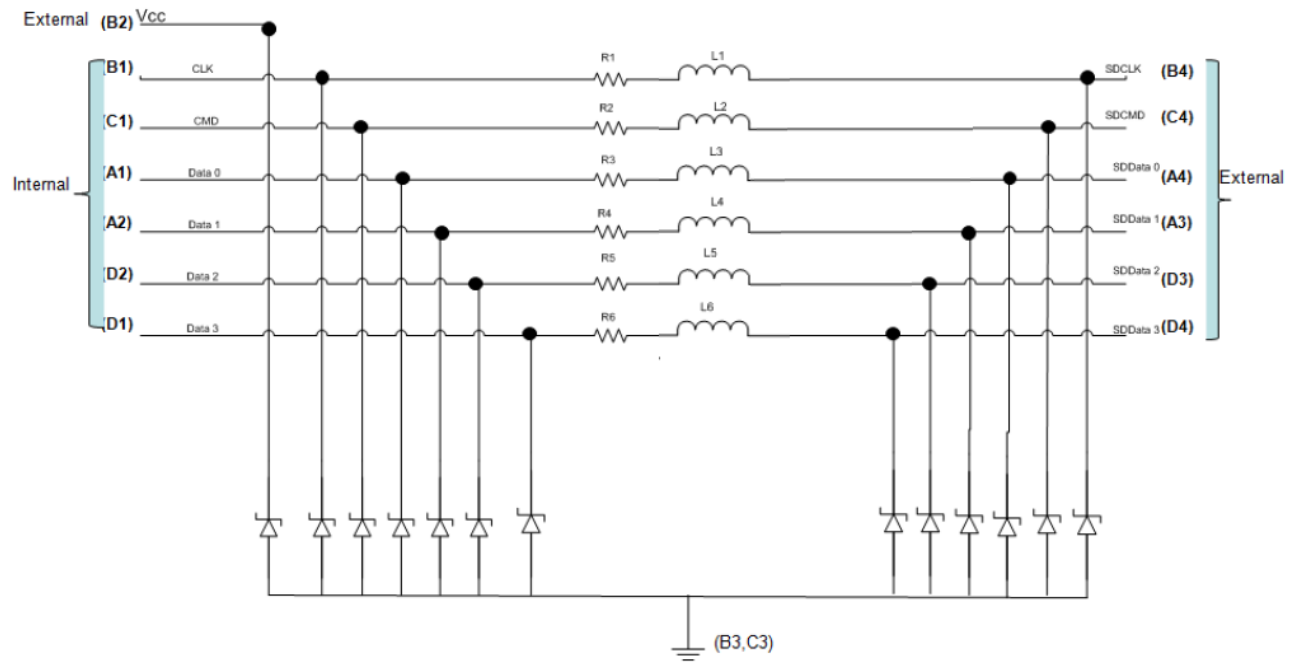

Figure 1. Electrical Schematic

Table 1. PIN DESCRIPTIONS

| Pin | Description      | Pin | Description              | Pin | Description    | Pin | Description      |
|-----|------------------|-----|--------------------------|-----|----------------|-----|------------------|
| A1  | data0 Internal   | B1  | clk Internal             | C1  | cmd Internal   | D1  | data3 Internal   |
| A2  | data1 Internal   | B2  | V <sub>CC</sub> External |     |                | D2  | data2 Internal   |
| A3  | SDdata1 External | B3  | GND                      | C3  | GND            | D3  | SDdata2 External |
| A4  | SDdata0 External | B4  | SDclk External           | C4  | SDcmd External | D4  | SDdata3 External |

# EMI7403

## ELECTRICAL SPECIFICATIONS AND CONDITIONS

**Table 2. PARAMETERS AND OPERATING CONDITIONS**

| Parameter                   | Rating      | Unit |
|-----------------------------|-------------|------|
| Storage Temperature Range   | -55 to +150 | °C   |
| Operating Temperature Range | -40 to +85  | °C   |

Functional operation above the stresses listed in the Recommended Operating Ranges is not implied. Extended exposure to stresses beyond the Recommended Operating Ranges limits may affect device reliability.

### ELECTRICAL CHARACTERISTICS (T<sub>A</sub> = 25°C unless otherwise noted)

| Symbol             | Parameter   | Test Conditions                  | Min       | Typ      | Max | Unit |
|--------------------|---|----------------------------------|-----------|----------|-----|------|
| V <sub>RWM</sub>   | Reverse Working Voltage   | (Note 3)                         |           | 3.3      |     | V    |
| V <sub>BR</sub>    | Breakdown Voltage   | I <sub>T</sub> = 1 mA; (Note 4)  | 6.0       |          | 9.0 | V    |
| I <sub>LEAK</sub>  | Channel Leakage Current   | V <sub>IN</sub> = 3.3 V          |           | 0.1      | 0.5 | μA   |
| R <sub>CH</sub>    | Channel Resistance (R1 to R6)   |                                  |           | 40       |     | Ω    |
| f <sub>3dB</sub>   | Cut-off Frequency   | 50 Ω Source and Load Termination |           | 300      |     | MHz  |
| F <sub>atten</sub> | Stop Band Attenuation   | @ 700 MHz<br>@ 900 MHz           |           | 20<br>35 |     | dB   |
| V <sub>ESD</sub>   | In-system ESD Withstand Voltage<br>a) Contact discharge per IEC 61000-4-2 standard, Level 4<br><b>(External Pins)</b><br>b) Contact discharge per IEC 61000-4-2 standard, Level 1<br><b>(Internal Pins)</b> | (Notes 1 and 2)                  | ±15<br>±2 |          |     | kV   |

Product parametric performance is indicated in the Electrical Characteristics for the listed test conditions, unless otherwise noted. Product performance may not be indicated by the Electrical Characteristics if operated under different conditions.

- Standard IEC61000-4-2 with C<sub>Discharge</sub> = 150 pF, R<sub>Discharge</sub> = 330, GND grounded.
- These measurements performed with no external capacitor.
- TVS devices are normally selected according to the working peak reverse voltage (V<sub>RWM</sub>), which should be equal to or greater than the DC or continuous peak operating voltage level.
- V<sub>BR</sub> is measured at pulse test current I<sub>T</sub>.

# EMI7403

## RF CHARACTERISTICS

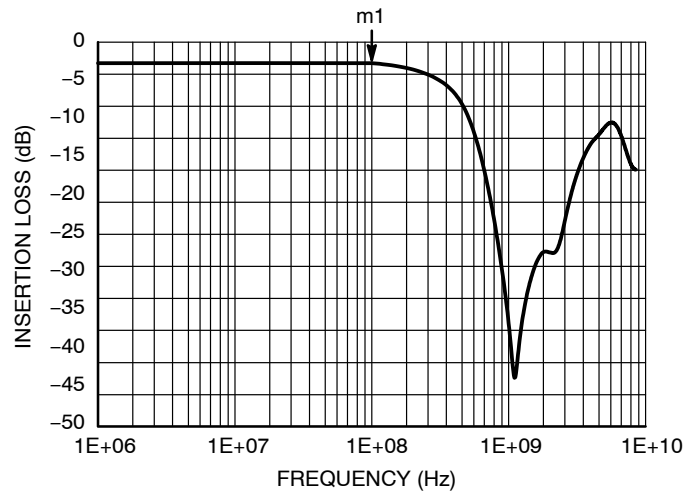

Figure 2. S21 Attenuation Simulation

| Interface   | Data Rate (Mbyte/s) | Fundamental Frequency (MHz) | EMI7403 Insertion Loss (dB) |
|-------------|---------------------|-----------------------------|-----------------------------|
| DDR50/SDR50 | 50                  | 100 (m1)                    | m1 = 3.27                   |

# EMI7403

## PACKAGE DIMENSIONS

WLCSP15, 1.56x1.56  
CASE 567FX  
ISSUE O

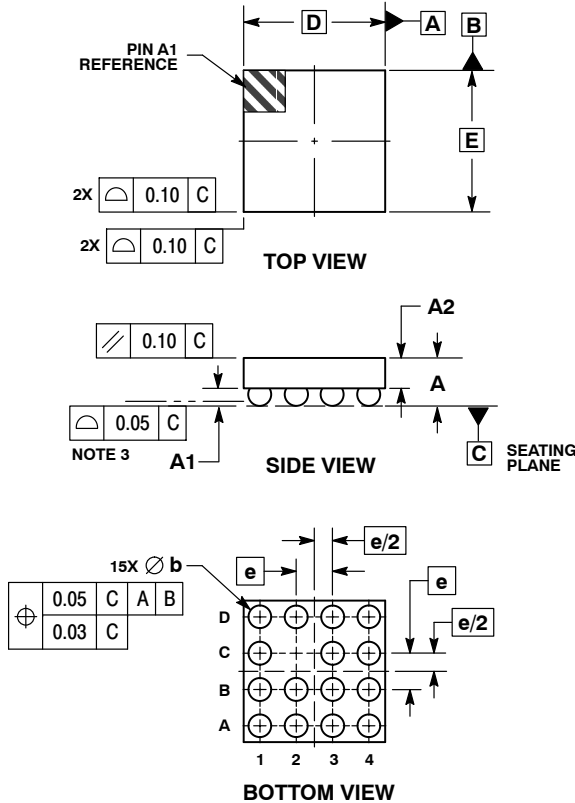

### NOTES:

1. DIMENSIONING AND TOLERANCING PER ASME Y14.5M, 1994.
2. CONTROLLING DIMENSION: MILLIMETERS.
3. COPLANARITY APPLIES TO SPHERICAL CROWNS OF SOLDER BALLS.

| DIM | MILLIMETERS |       |
|-----|-------------|-------|
|     | MIN         | MAX   |
| A   | 0.47        | 0.53  |
| A1  | 0.185       | 0.205 |
| A2  | 0.305 REF   |       |
| b   | 0.24        | 0.29  |
| D   | 1.56 BSC    |       |
| E   | 1.56 BSC    |       |
| e   | 0.40 BSC    |       |

### RECOMMENDED SOLDERING FOOTPRINT\*

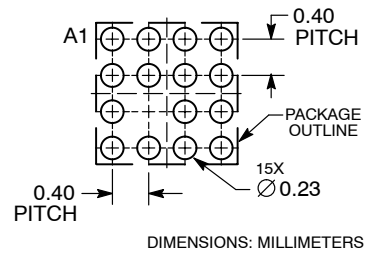

\*For additional information on our Pb-Free strategy and soldering details, please download the ON Semiconductor Soldering and Mounting Techniques Reference Manual, SOLDERRM/D.

ON Semiconductor and the  are registered trademarks of Semiconductor Components Industries, LLC (SCILLC) or its subsidiaries in the United States and/or other countries. SCILLC owns the rights to a number of patents, trademarks, copyrights, trade secrets, and other intellectual property. A listing of SCILLC's product/patent coverage may be accessed at [www.onsemi.com/site/pdf/Patent-Marketing.pdf](http://www.onsemi.com/site/pdf/Patent-Marketing.pdf). SCILLC reserves the right to make changes without further notice to any products herein. SCILLC makes no warranty, representation or guarantee regarding the suitability of its products for any particular purpose, nor does SCILLC assume any liability arising out of the application or use of any product or circuit, and specifically disclaims any and all liability, including without limitation special, consequential or incidental damages. "Typical" parameters which may be provided in SCILLC data sheets and/or specifications can and do vary in different applications and actual performance may vary over time. All operating parameters, including "Typicals" must be validated for each customer application by customer's technical experts. SCILLC does not convey any license under its patent rights nor the rights of others. SCILLC products are not designed, intended, or authorized for use as components in systems intended for surgical implant into the body, or other applications intended to support or sustain life, or for any other application in which the failure of the SCILLC product could create a situation where personal injury or death may occur. Should Buyer purchase or use SCILLC products for any such unintended or unauthorized application, Buyer shall indemnify and hold SCILLC and its officers, employees, subsidiaries, affiliates, and distributors harmless against all claims, costs, damages, and expenses, and reasonable attorney fees arising out of, directly or indirectly, any claim of personal injury or death associated with such unintended or unauthorized use, even if such claim alleges that SCILLC was negligent regarding the design or manufacture of the part. SCILLC is an Equal Opportunity/Affirmative Action Employer. This literature is subject to all applicable copyright laws and is not for resale in any manner.

### PUBLICATION ORDERING INFORMATION

**LITERATURE FULFILLMENT:**  
Literature Distribution Center for ON Semiconductor  
P.O. Box 5163, Denver, Colorado 80217 USA  
Phone: 303-675-2175 or 800-344-3860 Toll Free USA/Canada  
Fax: 303-675-2176 or 800-344-3867 Toll Free USA/Canada  
Email: [orderlit@onsemi.com](mailto:orderlit@onsemi.com)

**N. American Technical Support:** 800-282-9855 Toll Free  
USA/Canada  
**Europe, Middle East and Africa Technical Support:**  
Phone: 421 33 790 2910  
**Japan Customer Focus Center**  
Phone: 81-3-5817-1050

**ON Semiconductor Website:** [www.onsemi.com](http://www.onsemi.com)  
**Order Literature:** <http://www.onsemi.com/orderlit>

For additional information, please contact your local Sales Representative



Компания «ЭлектроПласт» предлагает заключение долгосрочных отношений при поставках импортных электронных компонентов на взаимовыгодных условиях!

Наши преимущества:

- Оперативные поставки широкого спектра электронных компонентов отечественного и импортного производства напрямую от производителей и с крупнейших мировых складов;
- Поставка более 17-ти миллионов наименований электронных компонентов;
- Поставка сложных, дефицитных, либо снятых с производства позиций;
- Оперативные сроки поставки под заказ (от 5 рабочих дней);
- Экспресс доставка в любую точку России;
- Техническая поддержка проекта, помощь в подборе аналогов, поставка прототипов;
- Система менеджмента качества сертифицирована по Международному стандарту ISO 9001;
- Лицензия ФСБ на осуществление работ с использованием сведений, составляющих государственную тайну;
- Поставка специализированных компонентов (Xilinx, Altera, Analog Devices, Intersil, Interpoint, Microsemi, Aeroflex, Peregrine, Syfer, Eurofarad, Texas Instrument, Miteq, Cobham, E2V, MA-COM, Hittite, Mini-Circuits, General Dynamics и др.);

Помимо этого, одним из направлений компании «ЭлектроПласт» является направление «Источники питания». Мы предлагаем Вам помощь Конструкторского отдела:

- Подбор оптимального решения, техническое обоснование при выборе компонента;
- Подбор аналогов;
- Консультации по применению компонента;
- Поставка образцов и прототипов;
- Техническая поддержка проекта;
- Защита от снятия компонента с производства.



#### Как с нами связаться

**Телефон:** 8 (812) 309 58 32 (многоканальный)

**Факс:** 8 (812) 320-02-42

**Электронная почта:** [org@eplast1.ru](mailto:org@eplast1.ru)

**Адрес:** 198099, г. Санкт-Петербург, ул. Калинина, дом 2, корпус 4, литера А.